

THIS DOCUMENT IS THE PROPERTY OF  
KEYSTONE ELECTRONICS CORP. AND  
SHALL NOT BE REPRODUCED, DISTRIBUTED  
OR USED AS A BASIS FOR MANUFACTURE  
WITHOUT PRIOR WRITTEN PERMISSION  
FROM KEYSTONE ELECTRONICS CORP.

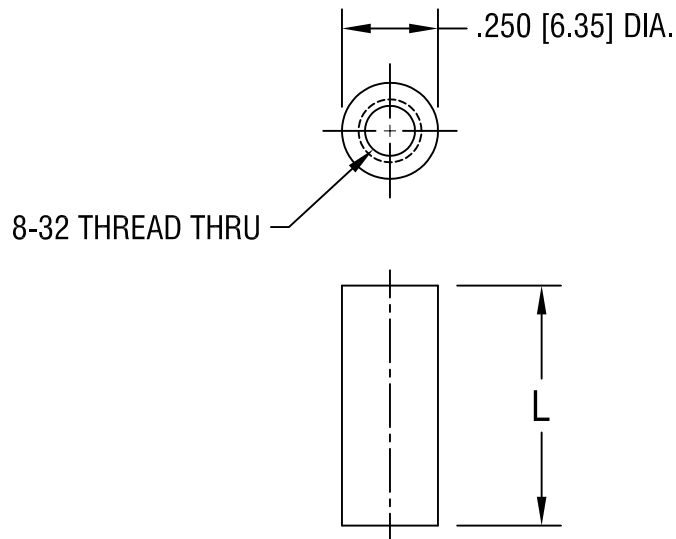

PART NO.	'L' DIM.
3492	.250 [6.35]
3493	.375 [9.52]
3494	.500 [12.70]
3495	.750 [19.05]
3496	1.000 [25.4]

**KEYSTONE ELECTRONICS CORP.**

ASTORIA, N.Y. 11105-2017

PART NAME

THREADED ROUND STANDOFF

MATERIAL

ALUMINUM

FINISH

CLEAR IRIDITE

DRN BY

BOONE

DATE

3.13.98

APP'D

LN

SCALE

2X

TOLERANCES

INCH [MM]

DECIMAL  $\pm .005$  [ $\pm 0.15$ ]

ANGULAR  $\pm 1^\circ$   
UNLESS OTHERWISE SPECIFIED

CODE

DWG NO.

C/M

3492-3496

DATE

DESCRIPTION

REV.

# Mouser Electronics

Authorized Distributor

Click to View Pricing, Inventory, Delivery & Lifecycle Information:

[Keystone Electronics:](#)

[3494](#)