

# Single/Dual/Quad 60MHz, 20V/ $\mu$ s, Low Power, Rail-to-Rail Input and Output Precision Op Amps

## FEATURES

- Gain Bandwidth Product: 60MHz
- Input Common Mode Range Includes Both Rails
- Output Swings Rail-to-Rail
- Low Quiescent Current: 1mA Max
- Input Offset Voltage: 350 $\mu$ V Max
- Input Bias Current: 150nA Max
- Wide Supply Range: 2.2V to 12.6V
- Large Output Current: 50mA Typ
- Low Voltage Noise: 10nV $\sqrt{\text{Hz}}$  Typ
- Slew Rate: 20V/ $\mu$ s Typ
- Common Mode Rejection: 102dB Typ
- Power Supply Rejection: 105dB Typ
- Open-Loop Gain: 100V/mV Typ
- Operating Temperature Range:  $-40^{\circ}\text{C}$  to  $85^{\circ}\text{C}$
- Single in the 8-Lead SO and 5-Lead Low Profile (1mm) ThinSOT™ Packages
- Dual in the 8-Lead SO and (3mm  $\times$  3mm) DFN Packages
- Quad in the 16-Lead SSOP Package

## APPLICATIONS

- Low Voltage, High Frequency Signal Processing
- Driving A/D Converters
- Rail-to-Rail Buffer Amplifiers
- Active Filters
- Video Amplifiers
- Fast Current Sensing Amplifiers

## DESCRIPTION

The **LT<sup>®</sup>6220/LT6221/LT6222** are single/dual/quad, low power, high speed rail-to-rail input and output operational amplifiers with excellent DC performance. The LT6220/LT6221/LT6222 feature reduced supply current, lower input offset voltage, lower input bias current and higher DC gain than other devices with comparable bandwidth.

Typically, the LT6220/LT6221/LT6222 have an input offset voltage of less than 100 $\mu$ V, an input bias current of less than 15nA and an open-loop gain of 100V/mV. The parts have an input range that includes both supply rails and an output that swings within 10mV of either supply rail to maximize the signal dynamic range in low supply applications.

The LT6220/LT6221/LT6222 maintain performance for supplies from 2.2V to 12.6V and are specified at 3V, 5V and  $\pm 5$ V supplies. The inputs can be driven beyond the supplies without damage or phase reversal of the output.

The LT6220 is housed in the 8-lead SO package with the standard op amp pinout as well as the 5-lead SOT-23 package. The LT6221 is available in 8-lead SO and DFN (3mm  $\times$  3mm low profile dual fine pitch leadless) packages with the standard op amp pinout. The LT6222 features the standard quad op amp configuration and is available in the 16-lead SSOP package. The LT6220/LT6221/LT6222 can be used as plug-in replacements for many op amps to improve input/output range and performance.

**LT**, **LT**, **LTC**, **LTM**, Linear Technology and the Linear logo are registered trademarks and ThinSOT is a trademark of Linear Technology Corporation. All other trademarks are the property of their respective owners.

## TYPICAL APPLICATION

### Stepped-Gain Photodiode Amplifier

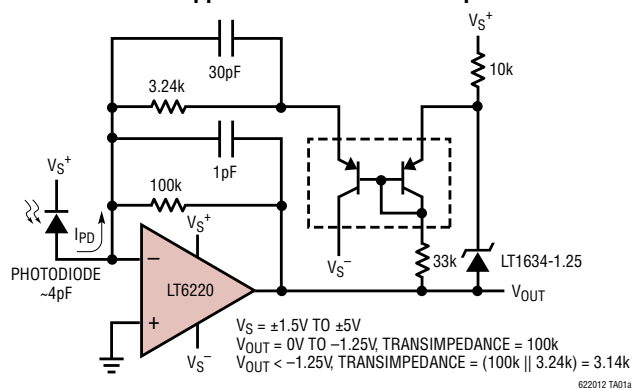

### $V_{OS}$ Distribution, $V_{CM} = 0\text{V}$ (S8, PNP Stage)

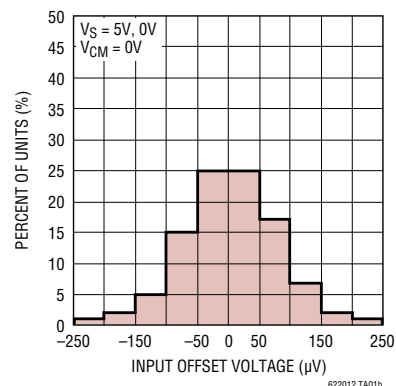

# LT6220/LT6221/LT6222

## ABSOLUTE MAXIMUM RATINGS (Note 1)

Total Supply Voltage ( $V_S^-$ to $V_S^+$ ) .....	12.6V	Maximum Junction Temperature .....	150°C
Input Voltage (Note 2).....	$\pm V_S$	(DD Package).....	125°C
Input Current (Note 2).....	$\pm 10\text{mA}$	Storage Temperature.....	-65°C to 150°C
Output Short Circuit Duration (Note 3) .....	Indefinite	(DD Package).....	-65°C to 125°C
Operating Temperature Range (Note 4)....	-40°C to 85°C	Lead Temperature (Soldering, 10 sec.).....	300°C
Specified Temperature Range (Note 5) ....	-40°C to 85°C		

## PIN CONFIGURATION

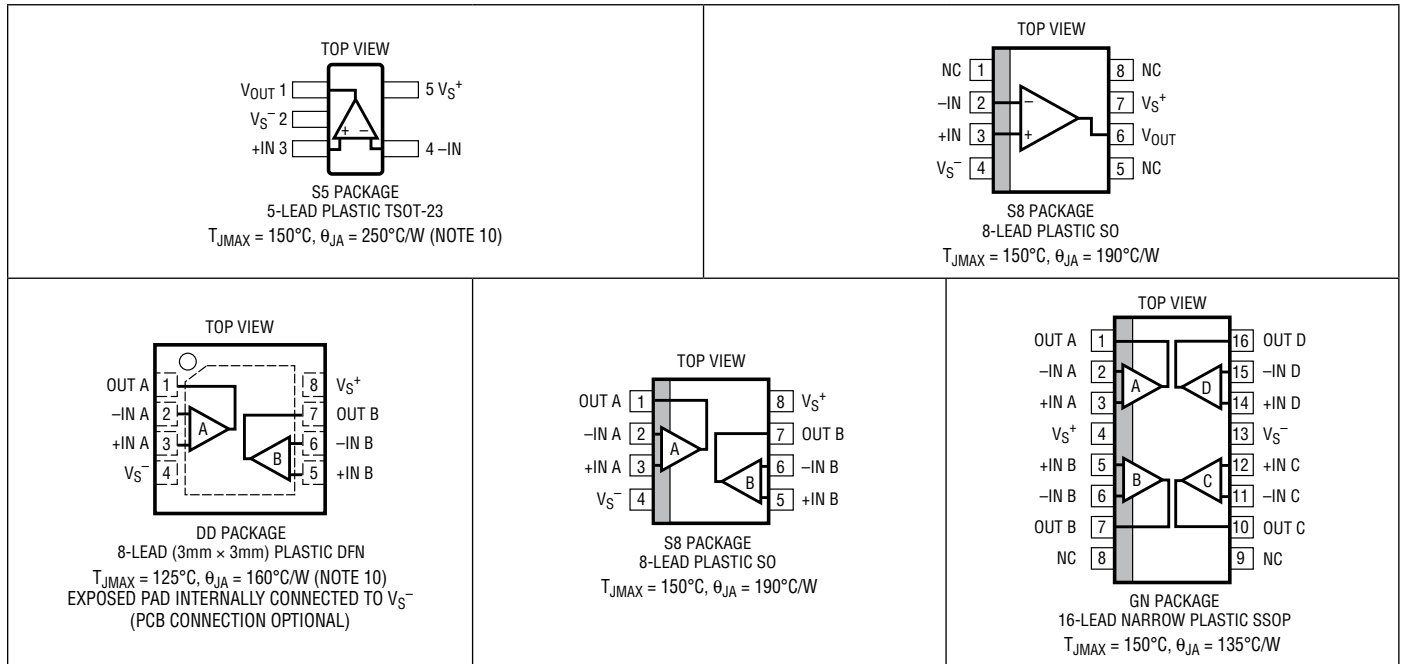

## ORDER INFORMATION

LEAD FREE FINISH	TAPE AND REEL	PART MARKING	PACKAGE DESCRIPTION	SPECIFIED TEMPERATURE RANGE
LT6220CS5#PBF	LT6220CS5#TRPBF	LTAFP	5-Lead Plastic TSOT-23	0°C to 70°C
LT6220IS5#PBF	LT6220IS5#TRPBF	LTAFP	5-Lead Plastic TSOT-23	-40°C to 85°C
LT6220CS8#PBF	LT6220CS8#TRPBF	6220	8-Lead Plastic SO	0°C to 70°C
LT6220IS8#PBF	LT6220IS8#TRPBF	6220I	8-Lead Plastic SO	-40°C to 85°C
LT6221CDD#PBF	LT6221CDD#TRPBF	LADZ	8-Lead (3mm x 3mm) Plastic DFN	0°C to 70°C
LT6221IDD#PBF	LT6221IDD#TRPBF	LADZ	8-Lead (3mm x 3mm) Plastic DFN	-40°C to 85°C
LT6221CS8#PBF	LT6221CS8#TRPBF	6221	8-Lead Plastic SO	0°C to 70°C
LT6221IS8#PBF	LT6221IS8#TRPBF	6221I	8-Lead Plastic SO	-40°C to 85°C
LT6222CGN#PBF	LT6222CGN#TRPBF	6222	16-Lead Narrow Plastic SSOP	0°C to 70°C
LT6222IGN#PBF	LT6222IGN#TRPBF	6222I	16-Lead Narrow Plastic SSOP	-40°C to 85°C

Consult LTC Marketing for parts specified with wider operating temperature ranges.

Consult LTC Marketing for information on nonstandard lead based finish parts.

For more information on lead free part marking, go to: <http://www.linear.com/leadfree/>

For more information on tape and reel specifications, go to: <http://www.linear.com/tapeandreeel/>

622012fc

## ELECTRICAL CHARACTERISTICS

T<sub>A</sub> = 25°C, V<sub>S</sub> = 5V, 0V; V<sub>S</sub> = 3V, 0V; V<sub>CM</sub> = V<sub>OUT</sub> = half supply, unless otherwise noted.

SYMBOL	PARAMETER	CONDITIONS	MIN	TYP	MAX	UNITS
V <sub>OS</sub>	Input Offset Voltage	V <sub>CM</sub> = 0V		70	350	μV
		V <sub>CM</sub> = 0V (DD Package)		150	700	μV
		V <sub>CM</sub> = 0V (S5 Package)		200	850	μV
		V <sub>CM</sub> = V <sub>S</sub>		0.5	2.5	mV
		V <sub>CM</sub> = V <sub>S</sub> (S5 Package)		0.5	3	mV
ΔV <sub>OS</sub>	Input Offset Voltage Shift	V <sub>S</sub> = 5V, V <sub>CM</sub> = 0V to 3.5V		30	195	μV
		V <sub>S</sub> = 3V, V <sub>CM</sub> = 0V to 1.5V		15	120	μV
	Input Offset Voltage Match (Channel-to-Channel) (Note 9)	V <sub>CM</sub> = 0V V <sub>CM</sub> = 0V (DD Package)		100 150	600 1100	μV μV
I <sub>B</sub>	Input Bias Current	V <sub>CM</sub> = 1V		15	150	nA
		V <sub>CM</sub> = V <sub>S</sub>		250	600	nA
	Input Bias Current Match (Channel-to-Channel) (Note 9)	V <sub>CM</sub> = 1V V <sub>CM</sub> = V <sub>S</sub>		15 20	175 250	nA nA
I <sub>OS</sub>	Input Offset Current	V <sub>CM</sub> = 1V		15	100	nA
		V <sub>CM</sub> = V <sub>S</sub>		15	100	nA
	Input Noise Voltage	0.1Hz to 10Hz		0.5		μV <sub>P-P</sub>
e <sub>n</sub>	Input Noise Voltage Density	f = 10kHz		10		nV/√Hz
i <sub>n</sub>	Input Noise Current Density	f = 10kHz		0.8		pA/√Hz
C <sub>IN</sub>	Input Capacitance			2		pF
A <sub>VOL</sub>	Large Signal Voltage Gain	V <sub>S</sub> = 5V, V <sub>OUT</sub> = 0.5V to 4.5V, R <sub>L</sub> = 1k at V <sub>S</sub> /2	35	100		V/mV
		V <sub>S</sub> = 5V, V <sub>OUT</sub> = 1V to 4V, R <sub>L</sub> = 100Ω at V <sub>S</sub> /2	3.5	10		V/mV
		V <sub>S</sub> = 3V, V <sub>OUT</sub> = 0.5V to 2.5V, R <sub>L</sub> = 1k at V <sub>S</sub> /2	30	90		V/mV
CMRR	Common Mode Rejection Ratio	V <sub>S</sub> = 5V, V <sub>CM</sub> = 0V to 3.5V	85	102		dB
		V <sub>S</sub> = 3V, V <sub>CM</sub> = 0V to 1.5V	82	102		dB
	CMRR Match (Channel-to-Channel) (Note 9)	V <sub>S</sub> = 5V, V <sub>CM</sub> = 0V to 3.5V V <sub>S</sub> = 3V, V <sub>CM</sub> = 0V to 1.5V	79 76	100 100		dB dB
	Input Common Mode Range		0		V <sub>S</sub>	V
PSRR	Power Supply Rejection Ratio	V <sub>S</sub> = 2.5V to 10V, V <sub>CM</sub> = 0V	84	105		dB
		PSRR Match (Channel-to-Channel) (Note 9)	79	105		dB
		Minimum Supply Voltage (Note 6)		2.2	2.5	
V <sub>OL</sub>	Output Voltage Swing LOW (Note 7)	No Load		5	40	mV
		I <sub>SINK</sub> = 5mA		100	200	mV
		I <sub>SINK</sub> = 20mA		325	650	mV
V <sub>OH</sub>	Output Voltage Swing HIGH (Note 7)	No Load		5	40	mV
		I <sub>SOURCE</sub> = 5mA		130	250	mV
		I <sub>SOURCE</sub> = 20mA		475	900	mV
I <sub>SC</sub>	Short-Circuit Current	V <sub>S</sub> = 5V	20	45		mA
		V <sub>S</sub> = 3V	20	35		mA
I <sub>S</sub>	Supply Current Per Amplifier			0.9	1	mA
GBW	Gain-Bandwidth Product	V <sub>S</sub> = 5V, Frequency = 1MHz	35	60		MHz
SR	Slew Rate	V <sub>S</sub> = 5V, A <sub>V</sub> = -1, R <sub>L</sub> = 1k, V <sub>OUT</sub> = 4V	10	20		V/μs
FPBW	Full Power Bandwidth	V <sub>S</sub> = 5V, A <sub>V</sub> = 1, V <sub>OUT</sub> = 4V <sub>P-P</sub>		1.6		MHz
HD	Harmonic Distortion	V <sub>S</sub> = 5V, A <sub>V</sub> = 1, R <sub>L</sub> = 1k, V <sub>OUT</sub> = 2V <sub>P-P</sub> , f <sub>C</sub> = 500kHz		-77.5		dBc
t <sub>S</sub>	Settling Time	0.01%, V <sub>S</sub> = 5V, V <sub>STEP</sub> = 2V, A <sub>V</sub> = 1, R <sub>L</sub> = 1k		300		ns
ΔG	Differential Gain (NTSC)	V <sub>S</sub> = 5V, A <sub>V</sub> = 2, R <sub>L</sub> = 1k		0.3		%
Δθ	Differential Phase (NTSC)	V <sub>S</sub> = 5V, A <sub>V</sub> = 2, R <sub>L</sub> = 1k		0.3		Deg

# LT6220/LT6221/LT6222

**ELECTRICAL CHARACTERISTICS** The ● denotes the specifications which apply over the  $0^{\circ}\text{C} \leq T_A \leq 70^{\circ}\text{C}$  temperature range.  $V_S = 5\text{V}, 0\text{V}; V_S = 3\text{V}, 0\text{V}; V_{\text{CM}} = V_{\text{OUT}} = \text{half supply}$ , unless otherwise noted.

SYMBOL	PARAMETER	CONDITIONS	MIN	TYP	MAX	UNITS
$V_{\text{OS}}$	Input Offset Voltage	$V_{\text{CM}} = 0\text{V}$	●	90	500	$\mu\text{V}$
		$V_{\text{CM}} = 0\text{V}$ (DD Package)	●	180	850	$\mu\text{V}$
		$V_{\text{CM}} = 0\text{V}$ (S5 Package)	●	230	1250	$\mu\text{V}$
		$V_{\text{CM}} = V_S$	●	0.5	3	mV
		$V_{\text{CM}} = V_S$ (S5 Package)	●	0.5	3.5	mV
$\Delta V_{\text{OS}}$	Input Offset Voltage Shift	$V_S = 5\text{V}, V_{\text{CM}} = 0\text{V}$ to 3.5V	●	30	280	$\mu\text{V}$
		$V_S = 3\text{V}, V_{\text{CM}} = 0\text{V}$ to 1.5V	●	15	190	$\mu\text{V}$
	Input Offset Voltage Match (Channel-to-Channel) (Note 9)	$V_{\text{CM}} = 0\text{V}$	●	110	850	$\mu\text{V}$
		$V_{\text{CM}} = 0\text{V}$ (DD Package)	●	180	1400	$\mu\text{V}$
$V_{\text{OS TC}}$	Input Offset Voltage Drift (Note 8)		●	1.5	5	$\mu\text{V}/^{\circ}\text{C}$
		(S5 Package)	●	3.5	10	$\mu\text{V}/^{\circ}\text{C}$
$I_B$	Input Bias Current	$V_{\text{CM}} = 1\text{V}$	●	20	175	nA
		$V_{\text{CM}} = V_S - 0.2\text{V}$	●	275	800	nA
	Input Bias Current Match (Channel-to-Channel) (Note 9)	$V_{\text{CM}} = 1\text{V}$	●	15	200	nA
		$V_{\text{CM}} = V_S - 0.2\text{V}$	●	20	300	nA
$I_{\text{OS}}$	Input Offset Current	$V_{\text{CM}} = 1\text{V}$	●	15	125	nA
		$V_{\text{CM}} = V_S - 0.2\text{V}$	●	15	125	nA
$A_{\text{VOL}}$	Large Signal Voltage Gain	$V_S = 5\text{V}, V_{\text{OUT}} = 0.5\text{V}$ to 4.5V, $R_L = 1\text{k}$ at $V_S/2$	●	30	90	V/mV
		$V_S = 5\text{V}, V_{\text{OUT}} = 1\text{V}$ to 4V, $R_L = 100\Omega$ at $V_S/2$	●	3	9	V/mV
		$V_S = 3\text{V}, V_{\text{OUT}} = 0.5\text{V}$ to 2.5V, $R_L = 1\text{k}$ at $V_S/2$	●	25	80	V/mV
CMRR	Common Mode Rejection Ratio	$V_S = 5\text{V}, V_{\text{CM}} = 0\text{V}$ to 3.5V	●	82	100	dB
		$V_S = 3\text{V}, V_{\text{CM}} = 0\text{V}$ to 1.5V	●	78	100	dB
	CMRR Match (Channel-to-Channel) (Note 9)	$V_S = 5\text{V}, V_{\text{CM}} = 0\text{V}$ to 3.5V	●	77	100	dB
		$V_S = 3\text{V}, V_{\text{CM}} = 0\text{V}$ to 1.5V	●	73	100	dB
	Input Common Mode Range		●	0	$V_S$	V
PSRR	Power Supply Rejection Ratio	$V_S = 2.5\text{V}$ to 10V, $V_{\text{CM}} = 0\text{V}$	●	81	104	dB
		PSRR Match (Channel-to-Channel) (Note 9)	●	76	104	dB
	Minimum Supply Voltage (Note 6)		●	2.2	2.5	V
$V_{\text{OL}}$	Output Voltage Swing LOW (Note 7)	No Load	●	8	50	mV
		$I_{\text{SINK}} = 5\text{mA}$	●	110	220	mV
		$I_{\text{SINK}} = 20\text{mA}$	●	375	750	mV
$V_{\text{OH}}$	Output Voltage Swing HIGH (Note 7)	No Load	●	8	50	mV
		$I_{\text{SOURCE}} = 5\text{mA}$	●	150	300	mV
		$I_{\text{SOURCE}} = 20\text{mA}$	●	600	1100	mV
$I_{\text{SC}}$	Short-Circuit Current	$V_S = 5\text{V}$	●	20	40	mA
		$V_S = 3\text{V}$	●	20	30	mA
$I_S$	Supply Current Per Amplifier		●	1	1.4	mA
GBW	Gain-Bandwidth Product	$V_S = 5\text{V}$ , Frequency = 1MHz	●	30	60	MHz
SR	Slew Rate	$V_S = 5\text{V}, AV = -1, R_L = 1\text{k}, V_{\text{OUT}} = 4V_{\text{P-P}}$	●	9	18	V/ $\mu\text{s}$

**ELECTRICAL CHARACTERISTICS** The ● denotes the specifications which apply over the  $-40^{\circ}\text{C} \leq T_A \leq 85^{\circ}\text{C}$  temperature range.  $V_S = 5\text{V}, 0\text{V}; V_S = 3\text{V}, 0\text{V}; V_{\text{CM}} = V_{\text{OUT}} = \text{half supply}$ , unless otherwise noted. (Note 5)

SYMBOL	PARAMETER	CONDITIONS	MIN	TYP	MAX	UNITS
$V_{\text{OS}}$	Input Offset Voltage	$V_{\text{CM}} = 0\text{V}$	●	125	700	$\mu\text{V}$
		$V_{\text{CM}} = 0\text{V}$ (DD Package)	●	300	1300	$\mu\text{V}$
		$V_{\text{CM}} = 0\text{V}$ (S5 Package)	●	350	2000	$\mu\text{V}$
		$V_{\text{CM}} = V_S$	●	0.75	3.5	mV
		$V_{\text{CM}} = V_S$ (S5 Package)	●	1	4.5	mV
$\Delta V_{\text{OS}}$	Input Offset Voltage Shift	$V_S = 5\text{V}, V_{\text{CM}} = 0\text{V}$ to $3.5\text{V}$	●	30	300	$\mu\text{V}$
		$V_S = 3\text{V}, V_{\text{CM}} = 0\text{V}$ to $1.5\text{V}$	●	30	210	$\mu\text{V}$
	Input Offset Voltage Match (Channel-to-Channel) (Note 9)	$V_{\text{CM}} = 0\text{V}$	●	175	1200	$\mu\text{V}$
		$V_{\text{CM}} = 0\text{V}$ (DD Package)	●	300	2200	$\mu\text{V}$
$V_{\text{OS TC}}$	Input Offset Voltage Drift (Note 8)		●	1.5	7.5	$\mu\text{V}/^{\circ}\text{C}$
		(S5 Package)	●	3.5	15	$\mu\text{V}/^{\circ}\text{C}$
$I_B$	Input Bias Current	$V_{\text{CM}} = 1\text{V}$	●	25	200	nA
		$V_{\text{CM}} = V_S - 0.2\text{V}$	●	300	900	nA
	Input Bias Current Match (Channel-to-Channel) (Note 9)	$V_{\text{CM}} = 1\text{V}$	●	15	250	nA
		$V_{\text{CM}} = V_S - 0.2\text{V}$	●	20	350	nA
$I_{\text{OS}}$	Input Offset Current	$V_{\text{CM}} = 1\text{V}$	●	20	150	nA
		$V_{\text{CM}} = V_S - 0.2\text{V}$	●	20	150	nA
$A_{\text{VOL}}$	Large Signal Voltage Gain	$V_S = 5\text{V}, V_{\text{OUT}} = 0.5\text{V}$ to $4.5\text{V}, R_L = 1\text{k}$ at $V_S/2$	●	25	70	V/mV
		$V_S = 5\text{V}, V_{\text{OUT}} = 1.5\text{V}$ to $3.5\text{V}, R_L = 100\Omega$ at $V_S/2$	●	2.5	8	V/mV
		$V_S = 3\text{V}, V_{\text{OUT}} = 0.5\text{V}$ to $2.5\text{V}, R_L = 1\text{k}$ at $V_S/2$	●	20	60	V/mV
$\text{CMRR}$	Common Mode Rejection Ratio	$V_S = 5\text{V}, V_{\text{CM}} = 0\text{V}$ to $3.5\text{V}$	●	81	100	dB
		$V_S = 3\text{V}, V_{\text{CM}} = 0\text{V}$ to $1.5\text{V}$	●	77	100	dB
	CMRR Match (Channel-to-Channel) (Note 9)	$V_S = 5\text{V}, V_{\text{CM}} = 0\text{V}$ to $3.5\text{V}$	●	76	100	dB
		$V_S = 3\text{V}, V_{\text{CM}} = 0\text{V}$ to $1.5\text{V}$	●	72	100	dB
	Input Common Mode Range		●	0	$V_S$	V
$\text{PSRR}$	Power Supply Rejection Ratio	$V_S = 2.5\text{V}$ to $10\text{V}, V_{\text{CM}} = 0\text{V}$	●	79	104	dB
			●	74	104	dB
	PSRR Match (Channel-to-Channel) (Note 9)		●			dB
	Minimum Supply Voltage (Note 6)		●	2.2	2.5	V
$V_{\text{OL}}$	Output Voltage Swing LOW (Note 7)	No Load	●	10	60	mV
		$I_{\text{SINK}} = 5\text{mA}$	●	120	240	mV
		$I_{\text{SINK}} = 10\text{mA}$	●	220	450	mV
$V_{\text{OH}}$	Output Voltage Swing HIGH (Note 7)	No Load	●	10	60	mV
		$I_{\text{SOURCE}} = 5\text{mA}$	●	160	325	mV
		$I_{\text{SOURCE}} = 10\text{mA}$	●	325	650	mV
$I_{\text{SC}}$	Short-Circuit Current	$V_S = 5\text{V}$	●	12.5	30	mA
		$V_S = 3\text{V}$	●	12.5	25	mA
$I_S$	Supply Current Per Amplifier		●	1.1	1.5	mA
$\text{GBW}$	Gain-Bandwidth Product	$V_S = 5\text{V}$ , Frequency = $1\text{MHz}$	●	25	50	MHz
$\text{SR}$	Slew Rate	$V_S = 5\text{V}, A_V = -1, R_L = 1\text{k}, V_{\text{OUT}} = 4\text{V}$	●	8	15	V/ $\mu\text{s}$

# LT6220/LT6221/LT6222

## ELECTRICAL CHARACTERISTICS

$T_A = 25^\circ\text{C}$ ,  $V_S = \pm 5\text{V}$ ,  $V_{CM} = 0\text{V}$ ,  $V_{OUT} = 0\text{V}$ , unless otherwise noted.

SYMBOL	PARAMETER	CONDITIONS	MIN	TYP	MAX	UNITS
$V_{OS}$	Input Offset Voltage	$V_{CM} = -5\text{V}$		80	500	$\mu\text{V}$
		$V_{CM} = -5\text{V}$ (DD Package)		150	750	$\mu\text{V}$
		$V_{CM} = -5\text{V}$ (S5 Package)		200	900	$\mu\text{V}$
		$V_{CM} = 5\text{V}$		0.7	2.5	mV
		$V_{CM} = 5\text{V}$ (S5 Package)		0.7	3	mV
$\Delta V_{OS}$	Input Offset Voltage Shift	$V_{CM} = -5\text{V}$ to $3.5\text{V}$		70	675	$\mu\text{V}$
		Input Offset Voltage Match (Channel-to-Channel) (Note 9)	$V_{CM} = -5\text{V}$ $V_{CM} = -5\text{V}$ (DD Package)	100	850	$\mu\text{V}$
$I_B$	Input Bias Current	$V_{CM} = -4\text{V}$		20	150	nA
		$V_{CM} = 5\text{V}$		250	700	nA
	Input Bias Current Match (Channel-to-Channel)	$V_{CM} = -4\text{V}$		15	175	nA
		$V_{CM} = 5\text{V}$		20	250	nA
$I_{OS}$	Input Offset Current	$V_{CM} = -4\text{V}$		15	100	nA
		$V_{CM} = 5\text{V}$		15	100	nA
	Input Noise Voltage	0.1Hz to 10Hz		0.5		$\mu\text{V}_{P-P}$
$e_n$	Input Noise Voltage Density	$f = 10\text{kHz}$		10		$\text{nV}/\sqrt{\text{Hz}}$
$i_n$	Input Noise Current Density	$f = 10\text{kHz}$		0.8		$\text{pA}/\sqrt{\text{Hz}}$
$C_{IN}$	Input Capacitance	$f = 100\text{kHz}$		2		pF
$A_{VOL}$	Large Signal Voltage Gain	$V_{OUT} = -4\text{V}$ to $4\text{V}$ , $R_L = 1\text{k}$	35	95		V/mV
		$V_{OUT} = -2\text{V}$ to $2\text{V}$ , $R_L = 100\Omega$	3.5	10		V/mV
CMRR	Common Mode Rejection Ratio	$V_{CM} = -5\text{V}$ to $3.5\text{V}$	82	102		dB
		CMRR Match (Channel-to-Channel)	77	100		dB
		Input Common Mode Range	$V_S^-$		$V_S^+$	
PSRR	Power Supply Rejection Ratio	$V_S^+ = 2.5\text{V}$ to $10\text{V}$ , $V_S^- = 0\text{V}$ , $V_{CM} = 0\text{V}$	84	105		dB
		PSRR Match (Channel-to-Channel)	79	105		dB
$V_{OL}$	Output Voltage Swing LOW (Note 7)	No Load		5	40	mV
		$I_{SINK} = 5\text{mA}$		100	200	mV
		$I_{SINK} = 20\text{mA}$		325	650	mV
$V_{OH}$	Output Voltage Swing HIGH (Note 7)	No Load		5	40	mV
		$I_{SOURCE} = 5\text{mA}$		130	250	mV
		$I_{SOURCE} = 20\text{mA}$		475	900	mV
$I_{SC}$	Short-Circuit Current		25	50		mA
$I_S$	Supply Current Per Amplifier			1	1.5	mA
GBW	Gain-Bandwidth Product	Frequency = 1MHz		60		MHz
SR	Slew Rate	$A_V = -1$ , $R_L = 1\text{k}$ , $V_{OUT} = \pm 4\text{V}$ , Measure at $V_{OUT} = \pm 2\text{V}$		20		V/ $\mu\text{s}$
FPBW	Full Power Bandwidth	$V_{OUT} = 8\text{V}_{P-P}$		0.8		MHz
HD	Harmonic Distortion	$A_V = 1$ , $R_L = 1\text{k}$ , $V_{OUT} = 2\text{V}_{P-P}$ , $f_C = 500\text{kHz}$		-77.5		dBc
$t_S$	Settling Time	0.01%, $V_{STEP} = 5\text{V}$ , $A_V = 1$ , $R_L = 1\text{k}$		375		ns
$\Delta G$	Differential Gain (NTSC)	$A_V = 2$ , $R_L = 1\text{k}$		0.15		%
$\Delta\theta$	Differential Phase (NTSC)	$A_V = 2$ , $R_L = 1\text{k}$		0.6		Deg

622012fc

**ELECTRICAL CHARACTERISTICS** The ● denotes the specifications which apply over the  $0^{\circ}\text{C} \leq T_A \leq 70^{\circ}\text{C}$  temperature range.  $V_S = \pm 5\text{V}$ ,  $V_{\text{CM}} = 0\text{V}$ ,  $V_{\text{OUT}} = 0\text{V}$ , unless otherwise noted.

SYMBOL	PARAMETER	CONDITIONS	MIN	TYP	MAX	UNITS
$V_{\text{OS}}$	Input Offset Voltage	$V_{\text{CM}} = -5\text{V}$	●	100	650	$\mu\text{V}$
		$V_{\text{CM}} = -5\text{V}$ (DD Package)	●	180	900	$\mu\text{V}$
		$V_{\text{CM}} = -5\text{V}$ (S5 Package)	●	230	1300	$\mu\text{V}$
		$V_{\text{CM}} = 5\text{V}$	●	0.75	3	mV
		$V_{\text{CM}} = 5\text{V}$ (S5 Package)	●	0.75	3.5	mV
$\Delta V_{\text{OS}}$	Input Offset Voltage Shift	$V_{\text{CM}} = -5\text{V}$ to $3.5\text{V}$	●	90	850	$\mu\text{V}$
	Input Offset Voltage Match (Channel-to-Channel) (Note 9)	$V_{\text{CM}} = -5\text{V}$ $V_{\text{CM}} = -5\text{V}$ (DD Package)	● ●	90 180	1100 1500	$\mu\text{V}$ $\mu\text{V}$
$V_{\text{OS TC}}$	Input Offset Voltage Drift (Note 8)		●	1.5	5	$\mu\text{V}/^{\circ}\text{C}$
		(S5 Package)	●	3.5	10	$\mu\text{V}/^{\circ}\text{C}$
$I_{\text{B}}$	Input Bias Current	$V_{\text{CM}} = -4\text{V}$ $V_{\text{CM}} = 4.8\text{V}$	● ●	20 275	175 800	nA nA
	Input Bias Current Match (Channel-to-Channel) (Note 9)	$V_{\text{CM}} = -4\text{V}$ $V_{\text{CM}} = 4.8\text{V}$	● ●	15 20	200 300	nA nA
$I_{\text{OS}}$	Input Offset Current	$V_{\text{CM}} = -4\text{V}$	●	15	125	nA
		$V_{\text{CM}} = 4.8\text{V}$	●	15	125	nA
$A_{\text{VOL}}$	Large Signal Voltage Gain	$V_{\text{OUT}} = -4\text{V}$ to $4\text{V}$ , $R_{\text{L}} = 1\text{k}$	●	30	90	V/mV
		$V_{\text{OUT}} = -2\text{V}$ to $2\text{V}$ , $R_{\text{L}} = 100\Omega$	●	3	9	V/mV
CMRR	Common Mode Rejection Ratio	$V_{\text{CM}} = -5\text{V}$ to $3.5\text{V}$	●	80	100	dB
	CMRR Match (Channel-to-Channel) (Note 9)		●	75	100	dB
	Input Common Mode Range		●	$V_{\text{S}}^{-}$	$V_{\text{S}}^{+}$	V
PSRR	Power Supply Rejection Ratio	$V_{\text{S}}^{+} = 2.5\text{V}$ to $10\text{V}$ , $V_{\text{S}}^{-} = 0\text{V}$ , $V_{\text{CM}} = 0\text{V}$	●	81	104	dB
	PSRR Match (Channel-to-Channel) (Note 9)		●	76	104	dB
$V_{\text{OL}}$	Output Voltage Swing LOW (Note 7)	No Load	●	8	50	mV
		$I_{\text{SINK}} = 5\text{mA}$	●	110	220	mV
		$I_{\text{SINK}} = 20\text{mA}$	●	375	750	mV
$V_{\text{OH}}$	Output Voltage Swing HIGH (Note 7)	No Load	●	8	50	mV
		$I_{\text{SOURCE}} = 5\text{mA}$	●	150	300	mV
		$I_{\text{SOURCE}} = 20\text{mA}$	●	600	1100	mV
$I_{\text{SC}}$	Short-Circuit Current		●	20	40	mA
$I_{\text{S}}$	Supply Current Per Amplifier		●	1.2	2	mA
GBW	Gain-Bandwidth Product	Frequency = $1\text{MHz}$	●	60		MHz
SR	Slew Rate	$A_{\text{V}} = -1$ , $R_{\text{L}} = 1\text{k}$ , $V_{\text{OUT}} = \pm 4\text{V}$ , Measure at $V_{\text{OUT}} = \pm 2\text{V}$	●	18		V/ $\mu\text{s}$

# LT6220/LT6221/LT6222

## ELECTRICAL CHARACTERISTICS

The ● denotes the specifications which apply over the  $-40^{\circ}\text{C} \leq T_A \leq 85^{\circ}\text{C}$  temperature range.  $V_S = \pm 5\text{V}$ ,  $V_{CM} = 0\text{V}$ ,  $V_{OUT} = 0\text{V}$ , unless otherwise noted. (Note 5)

SYMBOL	PARAMETER	CONDITIONS	MIN	TYP	MAX	UNITS
$V_{OS}$	Input Offset Voltage	$V_{CM} = -5\text{V}$	●	150	800	$\mu\text{V}$
		$V_{CM} = -5\text{V}$ (DD Package)	●	300	1300	$\mu\text{V}$
		$V_{CM} = -5\text{V}$ (S5 Package)	●	350	2000	$\mu\text{V}$
		$V_{CM} = 5\text{V}$	●	0.75	3.5	mV
		$V_{CM} = 5\text{V}$ (S5 Package)	●	1	4.5	mV
$\Delta V_{OS}$	Input Offset Voltage Shift	$V_{CM} = -5\text{V}$ to $3.5\text{V}$	●	90	950	$\mu\text{V}$
		Input Offset Voltage Match (Channel-to-Channel) (Note 9)	$V_{CM} = -5\text{V}$	●	175	1350
$V_{OS\ TC}$	Input Offset Voltage Drift (Note 8)	$V_{CM} = -5\text{V}$ to $3.5\text{V}$	●	300	2200	$\mu\text{V}$
		(S5 Package)	●	1.5	7.5	$\mu\text{V}/^{\circ}\text{C}$
$I_B$	Input Bias Current	$V_{CM} = -4\text{V}$	●	25	200	nA
		$V_{CM} = 4.8\text{V}$	●	300	900	nA
$I_{OS}$	Input Bias Current Match (Channel-to-Channel) (Note 9)	$V_{CM} = -4\text{V}$	●	15	250	nA
		$V_{CM} = 4.8\text{V}$	●	20	350	nA
$I_{OS}$	Input Offset Current	$V_{CM} = -4\text{V}$	●	20	150	nA
		$V_{CM} = 4.8\text{V}$	●	20	150	nA
$A_{VOL}$	Large Signal Voltage Gain	$V_{OUT} = -4\text{V}$ to $4\text{V}$ , $R_L = 1\text{k}$	●	25	70	V/mV
		$V_{OUT} = -1\text{V}$ to $1\text{V}$ , $R_L = 100\Omega$	●	2.5	8	V/mV
CMRR	Common Mode Rejection Ratio	$V_{CM} = -5\text{V}$ to $3.5\text{V}$	●	79	100	dB
	CMRR Match (Channel-to-Channel) (Note 9)		●	74	100	dB
	Input Common Mode Range		●	-5	5	V
PSRR	Power Supply Rejection Ratio	$V_S^+ = 2.5\text{V}$ to $10\text{V}$ , $V_S^- = 0\text{V}$ , $V_{CM} = 0\text{V}$	●	79	104	dB
	PSRR Match (Channel-to-Channel) (Note 9)		●	74	104	dB
$V_{OL}$	Output Voltage Swing LOW (Note 7)	No Load	●	10	60	mV
		$I_{SINK} = 5\text{mA}$	●	120	240	mV
		$I_{SINK} = 10\text{mA}$	●	220	450	mV
$V_{OH}$	Output Voltage Swing HIGH (Note 7)	No Load	●	10	60	mV
		$I_{SOURCE} = 5\text{mA}$	●	160	325	mV
		$I_{SOURCE} = 10\text{mA}$	●	325	650	mV
$I_{SC}$	Short-Circuit Current		●	12.5	30	mA
$I_S$	Supply Current		●	1.4	2.25	mA
GBW	Gain-Bandwidth Product	Frequency = $1\text{MHz}$	●	50		MHz
SR	Slew Rate	$A_V = -1$ , $R_L = 1\text{k}$ , $V_{OUT} = \pm 4\text{V}$ , Measure at $V_{OUT} = \pm 2\text{V}$	●	15		V/ $\mu\text{s}$

**Note 1:** Stresses beyond those listed under Absolute Maximum Ratings may cause permanent damage to the device. Exposure to any Absolute Maximum Rating condition for extended periods may affect device reliability and lifetime.

**Note 2:** The inputs are protected by back-to-back diodes. If the differential input voltage exceeds  $1.4\text{V}$ , the input current should be limited to less than  $10\text{mA}$ .

**Note 3:** A heat sink may be required to keep the junction temperature below the absolute maximum rating when the output is shorted indefinitely.

**Note 4:** The LT6220C/LT6221C/LT6222C and LT6220I/LT6221I/LT6222I are guaranteed functional over the temperature range of  $-40^{\circ}\text{C}$  and  $85^{\circ}\text{C}$ .

**Note 5:** The LT6220C/LT6221C/LT6222C are guaranteed to meet specified performance from  $0^{\circ}\text{C}$  to  $70^{\circ}\text{C}$ . The LT6220C/LT6221C/LT6222C are designed, characterized and expected to meet specified performance from  $-40^{\circ}\text{C}$  to  $85^{\circ}\text{C}$  but is not tested or QA sampled at these temperatures. The

LT6220I/LT6221I/LT6222I are guaranteed to meet specified performance from  $-40^{\circ}\text{C}$  to  $85^{\circ}\text{C}$ .

**Note 6:** Minimum supply voltage is guaranteed by power supply rejection ratio test.

**Note 7:** Output voltage swings are measured between the output and power supply rails.

**Note 8:** This parameter is not 100% tested.

**Note 9:** Matching parameters are the difference between amplifiers A and D and between B and C on the LT6222; between the two amplifiers on the LT6221.

**Note 10:** Thermal resistance ( $\theta_{JA}$ ) varies with the amount of PC board metal connected to the package. The specified values are for short traces connected to the leads. If desired, the thermal resistance can be substantially reduced by connecting Pin 2 of the LT6220CS5/LT6220IS5 or the underside metal of DD packages to a larger metal area ( $V_S^-$  trace).

622012fc



# TYPICAL PERFORMANCE CHARACTERISTICS

**$V_{OS}$  Distribution,  $V_{CM} = 0V$   
(S8, PNP Stage)**

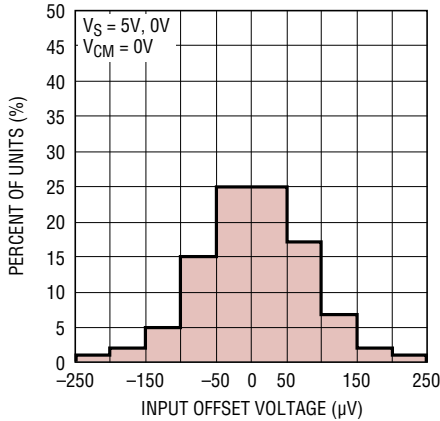

**$V_{OS}$  Distribution,  $V_{CM} = 0V$   
(SOT5, PNP Stage)**

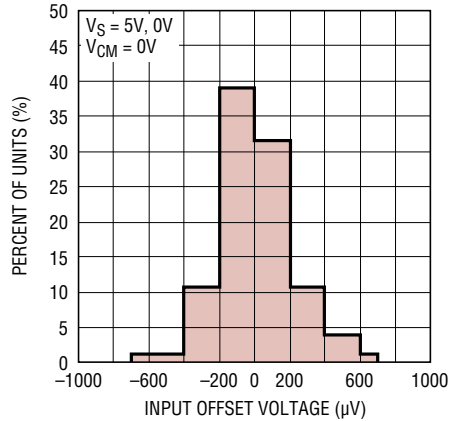

**$V_{OS}$  Distribution,  $V_{CM} = 5V$   
(S8, NPN Stage)**

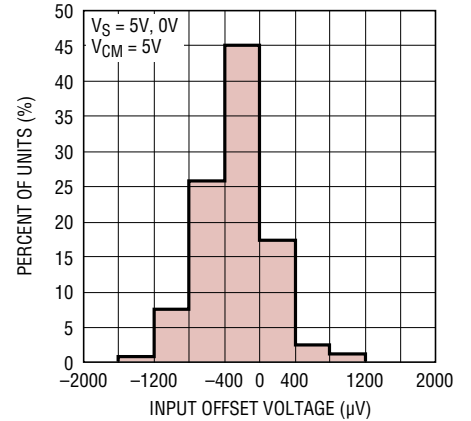

**$V_{OS}$  Distribution,  $V_{CM} = 5V$   
(SOT5, NPN Stage)**

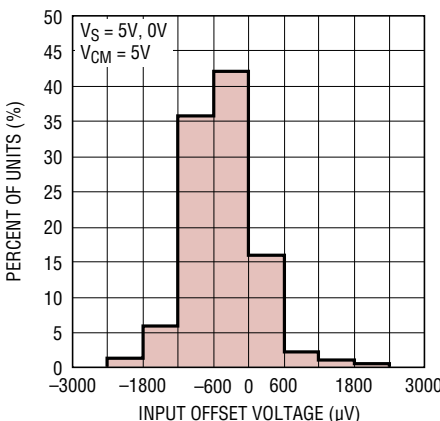

**Supply Current vs Supply Voltage**

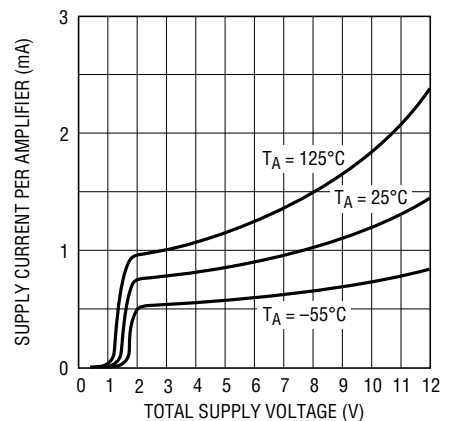

**Offset Voltage vs Input Common Mode Voltage**

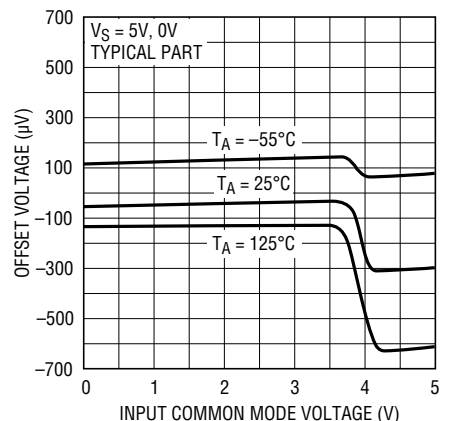

**Input Bias Current vs Common Mode Voltage**

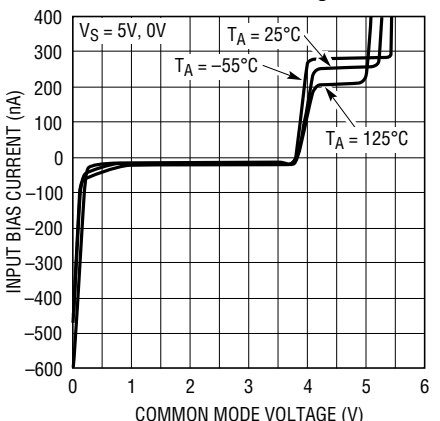

**Input Bias Current vs Temperature**

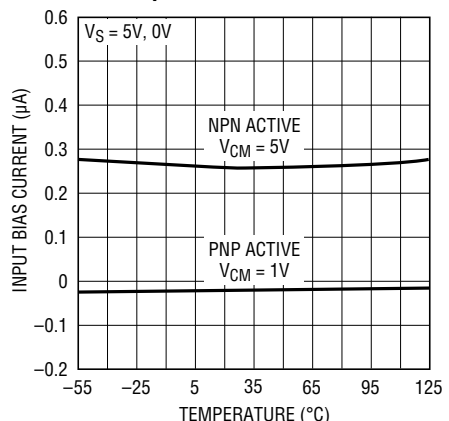

**Output Saturation Voltage vs Load Current (Output Low)**

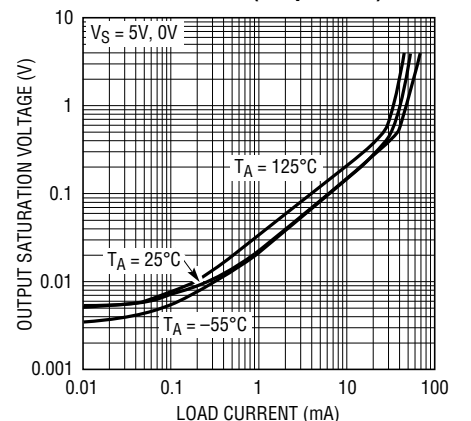

TYPICAL PERFORMANCE CHARACTERISTICS

Output Saturation Voltage vs Load Current (Output High)

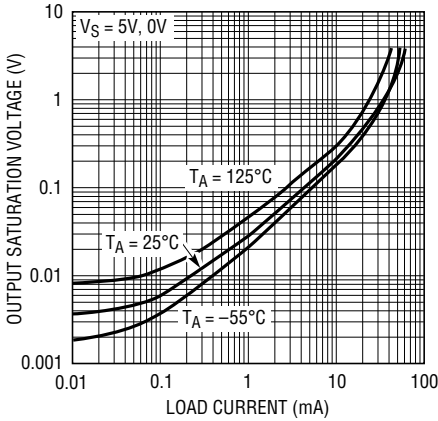

622012 G10

Minimum Supply Voltage

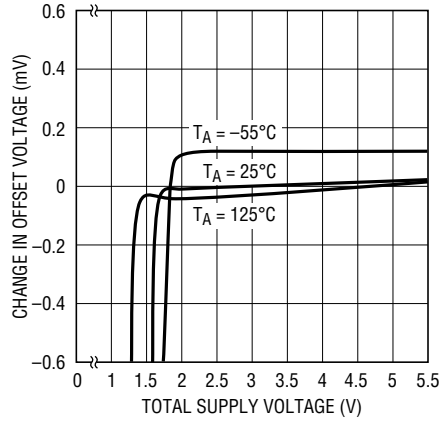

622012 G11

Output Short-Circuit Current vs Power Supply Voltage

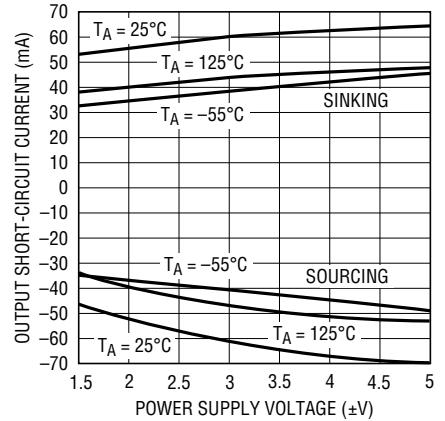

622012 G12

Open-Loop Gain

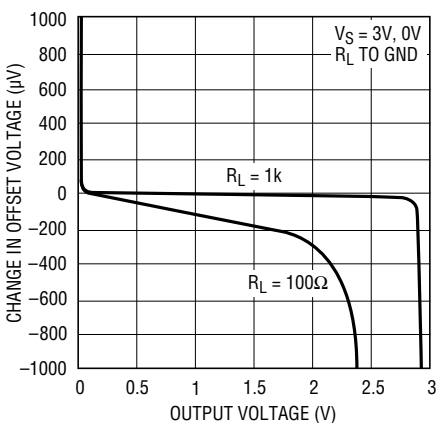

622012 G13

Open-Loop Gain

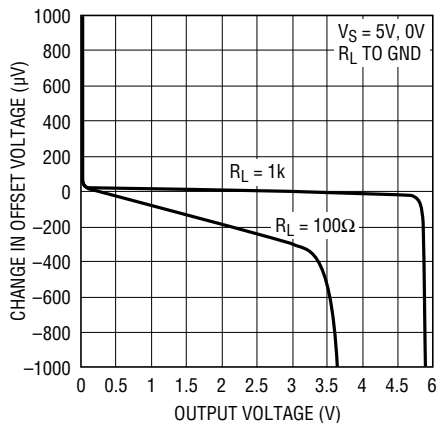

622012 G14

Open-Loop Gain

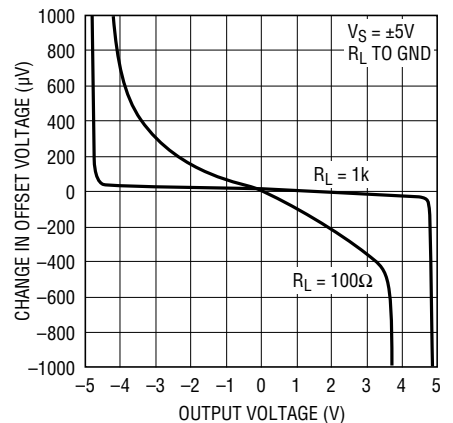

622012 G15

Offset Voltage vs Output Current

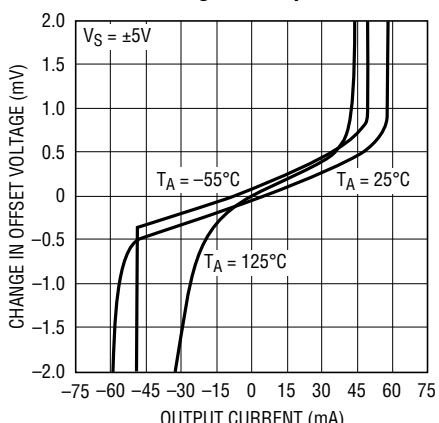

622012 G16

Warm-Up Drift vs Time

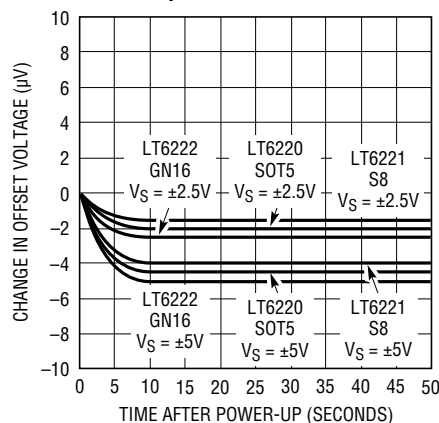

622012 G17

Input Noise Voltage vs Frequency

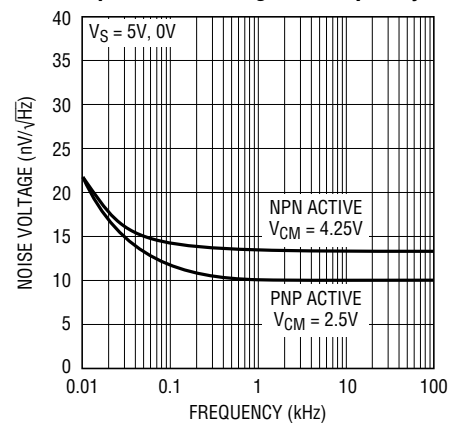

622012 G18

622012fc

# TYPICAL PERFORMANCE CHARACTERISTICS

**Input Current Noise vs Frequency**

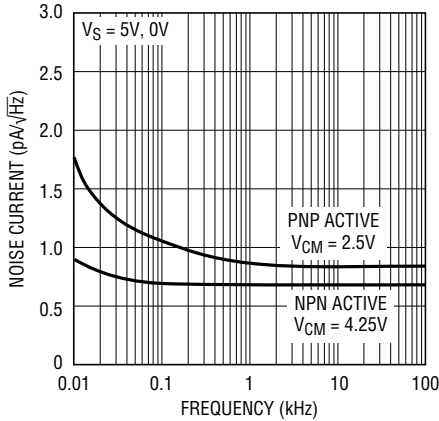

622012 G19

**0.1Hz to 10Hz Output Voltage Noise**

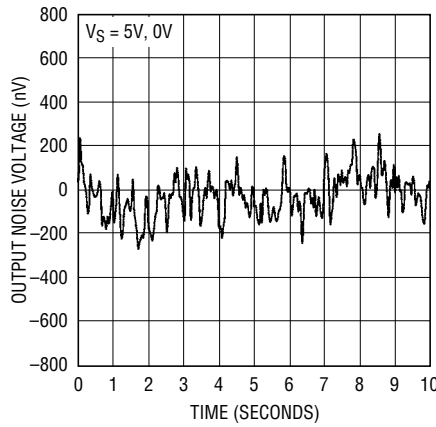

622012 G20

**Gain Bandwidth and Phase Margin vs Supply Voltage**

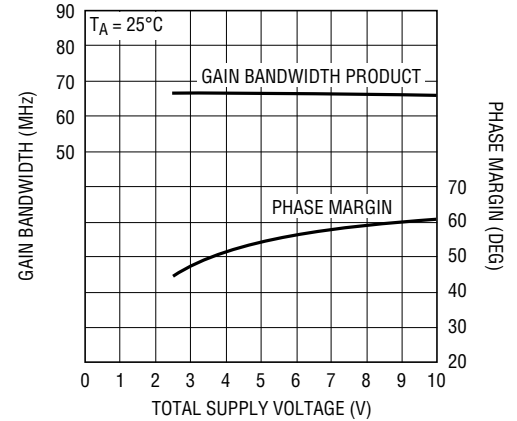

622012 G21

**Gain Bandwidth and Phase Margin vs Temperature**

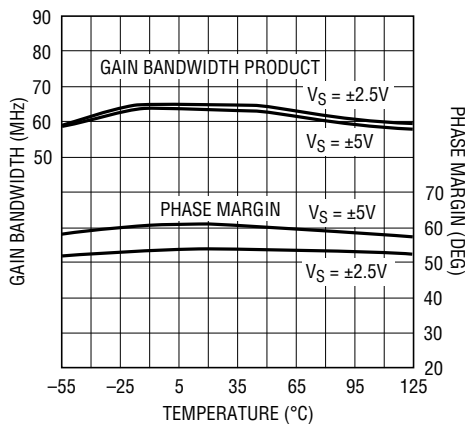

622012 G22

**Gain and Phase vs Frequency**

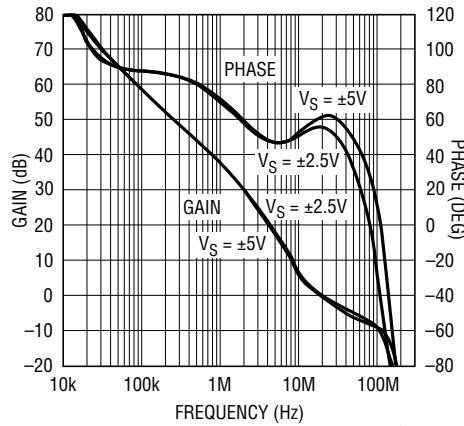

622012 G23

**Slew Rate vs Temperature**

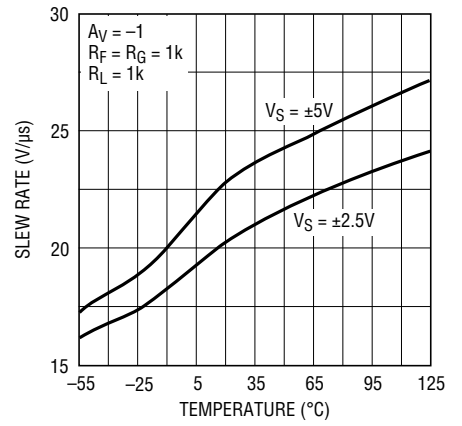

622012 G24

**Gain vs Frequency (AV = 1)**

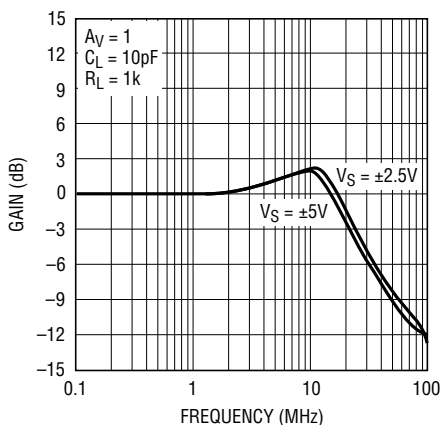

622012 G25

**Gain vs Frequency (AV = 2)**

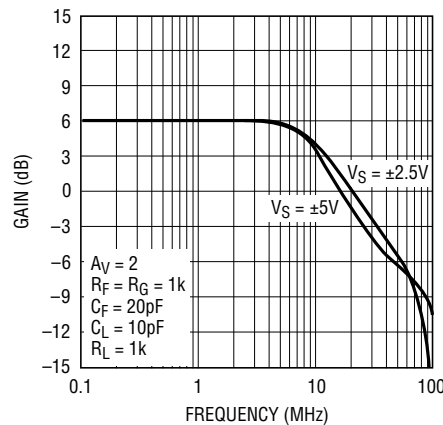

622012 G26

**Output Impedance vs Frequency**

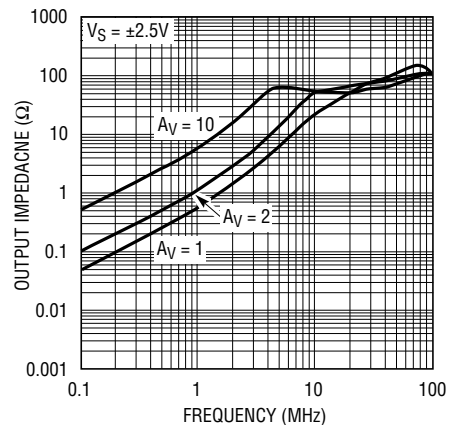

622012 G27

## TYPICAL PERFORMANCE CHARACTERISTICS

**Common Mode Rejection Ratio vs Frequency**

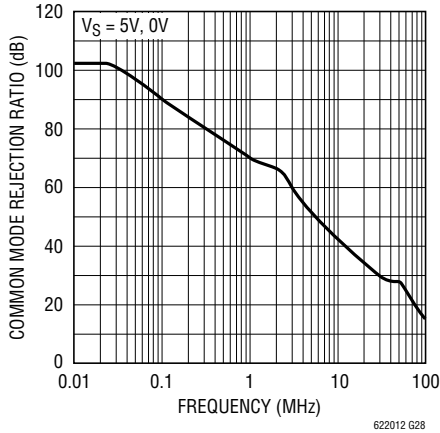

**Power Supply Rejection Ratio vs Frequency**

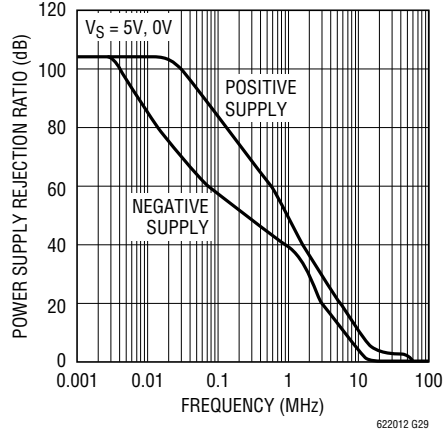

**Series Output Resistor vs Capacitive Load**

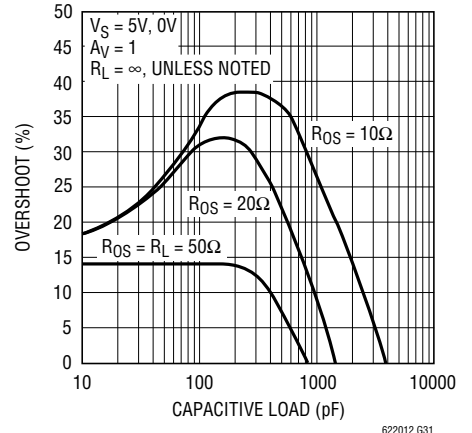

**Series Output Resistor vs Capacitive Load**

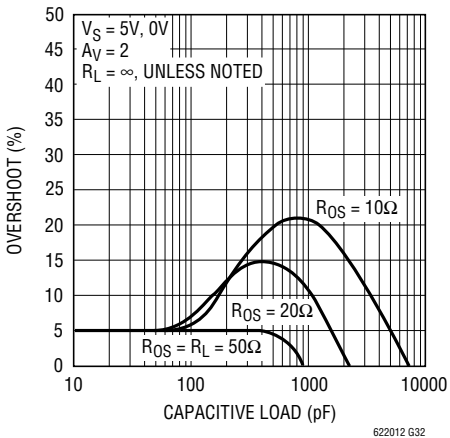

**Distortion vs Frequency**

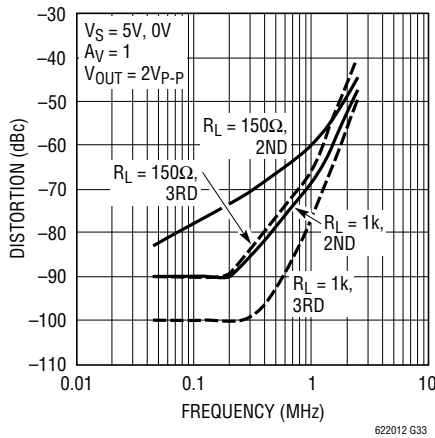

**Distortion vs Frequency**

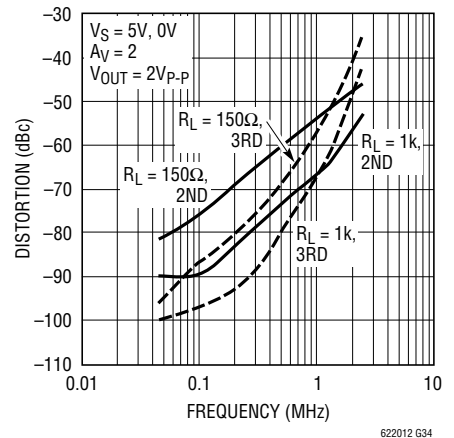

**Maximum Undistorted Output Signal vs Frequency**

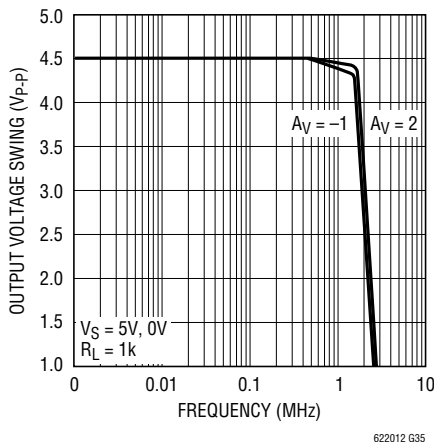

**5V Large-Signal Response**

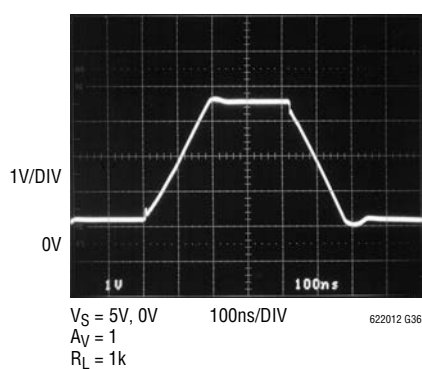

**5V Small-Signal Response**

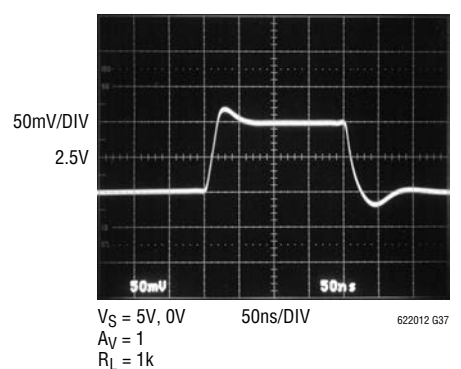

## TYPICAL PERFORMANCE CHARACTERISTICS

±5V Large-Signal Response

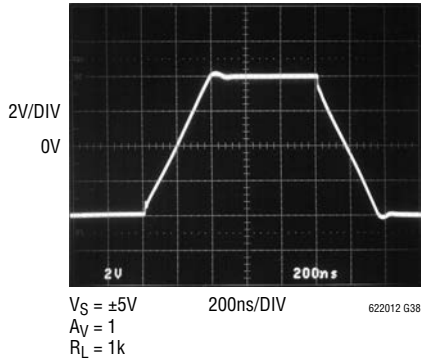

±5V Small-Signal Response

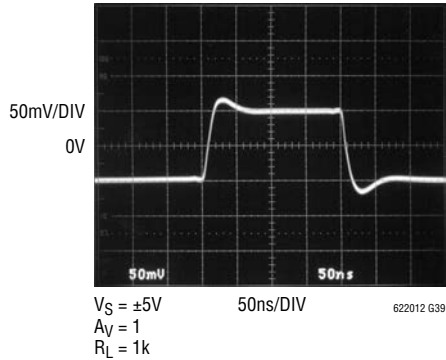

Output Overdriven Recovery

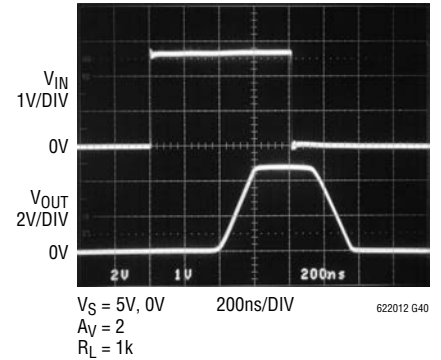

## APPLICATIONS INFORMATION

### Circuit Description

The LT6220/LT6221/LT6222 have an input and output signal range that covers from the negative power supply to the positive power supply. Figure 1 depicts a simplified schematic of the amplifier. The input stage comprises two differential amplifiers, a PNP stage, Q1/Q2, and an NPN stage, Q3/Q4, that are active over different ranges of common mode input voltage. The PNP stage is active between the negative supply to approximately 1.2V below the positive supply. As the input voltage moves closer toward the positive supply, the transistor Q5 will steer the

tail current,  $I_1$ , to the current mirror, Q6/Q7, activating the NPN differential pair and the PNP pair becomes inactive for the rest of the input common mode range up to the positive supply. Also, at the input stage, devices Q17 to Q19 act to cancel the bias current of the PNP input pair. When Q1/Q2 are active, the current in Q16 is controlled to be the same as the current Q1/Q2. Thus, the base current of Q16 is nominally equal to the base current of the input devices. The base current of Q16 is then mirrored by devices Q17-Q19 to cancel the base current of the input devices Q1/Q2.

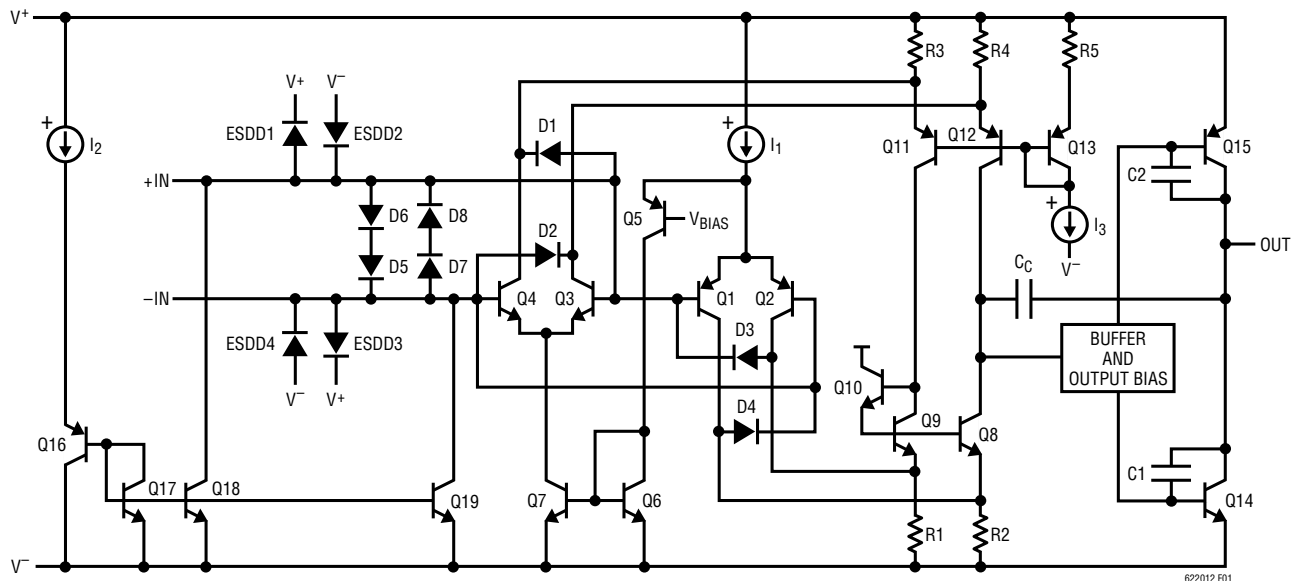

Figure 1. LT6220/LT6221/LT6222 Simplified Schematic Diagram

622012fc

## APPLICATIONS INFORMATION

A pair of complementary common emitter stages Q14/Q15 that enable the output to swing from rail-to-rail construct the output stage. The capacitors C2 and C3 form the local feedback loops that lower the output impedance at high frequency. These devices are fabricated by Linear Technology's proprietary high speed complementary bipolar process.

### Power Dissipation

The LT6222, with four amplifiers, is housed in a small 16-lead SSOP package and typically has a thermal resistance ( $\theta_{JA}$ ) of 135°C/W. It is necessary to ensure that the die's junction temperature does not exceed 150°C. The junction temperature,  $T_J$ , is calculated from the ambient temperature,  $T_A$ , power dissipation,  $P_D$ , and thermal resistance,  $\theta_{JA}$ :

$$T_J = T_A + (P_D \cdot \theta_{JA})$$

The power dissipation in the IC is the function of the supply voltage, output voltage and the load resistance. For a given supply voltage, the worst-case power dissipation  $P_{D(MAX)}$  occurs when the maximum supply current and the output voltage is at half of either supply voltage for a given load resistance.  $P_{D(MAX)}$  is given by:

$$P_{D(MAX)} = (V_S \cdot I_{S(MAX)}) + \left(\frac{V_S}{2}\right)^2 / R_L$$

Example: For an LT6222 in a 16-lead SSOP package operating on  $\pm 5V$  supplies and driving a 100 $\Omega$  load, the worst-case power dissipation is given by:

$$\begin{aligned} P_{D(MAX)}/\text{Amp} &= (10 \cdot 1.8\text{mA}) + (2.5)^2 / 100 \\ &= 0.018 + 0.0625 = 80.5\text{mW} \end{aligned}$$

If all four amplifiers are loaded simultaneously, then the total power dissipation is 322mW.

The maximum ambient temperature at which the part is allowed to operate is:

$$\begin{aligned} T_A &= T_J - (P_{D(MAX)} \cdot 135^\circ\text{C/W}) \\ &= 150^\circ\text{C} - (0.322\text{W} \cdot 135^\circ\text{C/W}) = 106.5^\circ\text{C} \end{aligned}$$

### Input Offset Voltage

The offset voltage will change depending upon which input stage is active. The PNP input stage is active from the negative supply rail to 1.2V below the positive supply rail, then the NPN input stage is activated for the remaining input range up to the positive supply rail during which the PNP stage remains inactive. The offset voltage is typically less than 70 $\mu$ V in the range that the PNP input stage is active.

### Input Bias Current

The LT6220/LT6221/LT6222 employ a patent pending technique to trim the input bias current to less than 150nA for the input common mode voltage of 0.2V above the negative supply rail to 1.2V below the positive rail. The low input offset voltage and low input bias current of the LT6220/LT6221/LT6222 provide precision performance especially for high source impedance applications.

### Output

The LT6220/LT6221/LT6222 can deliver a large output current, so the short-circuit current limit is set around 50mA to prevent damage to the device. Attention must be paid to keep the junction temperature of the IC below the absolute maximum rating of 150°C (refer to the Power Dissipation section) when the output is in continuous short circuit. The output of the amplifier has reverse-biased diodes connected to each supply. If the output is forced beyond either supply, unlimited current will flow through these diodes. If the current is transient and limited to several hundred milliamperes, no damage will occur to the device.

### Overdrive Protection

When the input voltage exceeds the power supplies, two pair of crossing diodes, D1 to D4, will prevent the output from reversing polarity. If the input voltage exceeds either power supply by 700mV, diode D1/D2 or D3/D4 will turn on to keep the output at the proper polarity. For the phase reversal protection to perform properly, the input current must be limited to less than 5mA. If the amplifier

## APPLICATIONS INFORMATION

is severely overdriven, an external resistor should be used to limit the overdriven current.

The LT6220/LT6221/LT6222's input stages are also protected against a large differential input voltage of 1.4V or higher by a pair of back-to-back diodes, D5/D8, to prevent the emitter-base breakdown of the input transistors. The current in these diodes should be limited to less than 10mA when they are active. The worse-case differential input voltage usually occurs when the input is driven while the output is shorted to ground in a unity-gain configuration. In addition, the amplifier is protected against ESD strikes up to 3kV on all pins by a pair of protection diodes on each pin that are connected to the power supplies as shown in Figure 1.

### Capacitive Load

The LT6220/LT6221/LT6222 are optimized for high bandwidth, low power and precision applications. They can drive a capacitive load up to 100pF in a unity-gain configuration and more for higher gain. When driving a

larger capacitive load, a resistor of 10Ω to 50Ω should be connected between the output and the capacitive load to avoid ringing or oscillation. The feedback should still be taken from the output so that the resistor will isolate the capacitive load to ensure stability. Graphs on capacitive loads show the transient response of the amplifier when driving capacitive load with specified series resistors.

### Feedback Components

When feedback resistors are used to set up gain, care must be taken to ensure that the pole formed by the feedback resistors and the total capacitance at the inverting input does not degrade stability. For instance, the LT6220/LT6221/LT6222, set up with a noninverting gain of 2, two 5k resistors and a capacitance of 5pF (part plus PC board), will probably oscillate. The pole is formed at 12.7MHz that will reduce phase margin by 52 degrees when the crossover frequency of the amplifier is around 10MHz. A capacitor of 10pF or higher connecting across the feedback resistor will eliminate any ringing or oscillation.

## TYPICAL APPLICATIONS

### Stepped-Gain Photodiode Amplifier

The circuit of Figure 2 is a stepped gain transimpedance photodiode amplifier. At low signal levels, the circuit has a high 100kΩ gain, but at high signal levels the circuit automatically and smoothly changes to a low 3.2kΩ gain. The benefit of a stepped gain approach is that it maximizes dynamic range, which is very useful on limited supplies. Put another way, in order to get 100kΩ sensitivity and still handle a 1mA signal level without resorting to gain reduction, the circuit would need a 100V negative voltage supply.

The operation of the circuit is quite simple. At low photodiode currents (below 10μA) the output and inverting input of the op amp will be no more than 1V below ground. The LT1634 in parallel with R3 and Q2 keep a constant current though Q2 of about 20μA. R4 maintains quiescent current through the LT1634 and pulls Q2's emitter above ground,

so Q1 is reverse biased and no current flows through R2. So for small signals, the only feedback path is R1 (and C1) and the circuit is a simple transimpedance amplifier with 100kΩ gain.

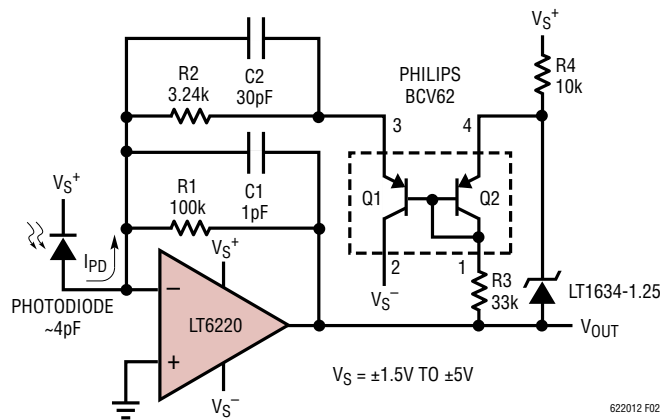

Figure 2. Stepped-Gain Photodiode Amplifier

## TYPICAL APPLICATIONS

As the signal level increases though, the output of the op amp goes more negative. At 12.5µA of photodiode current, the 100kΩ gain dictates that the LT6220 output will be about 1.25V below ground. However, at that point the emitter of Q2 will be at ground, and the base of Q1 will be 1V below ground. Thus, Q1 turns on and photodiode current starts to flow through R2. The transimpedance gain is therefore now reduced to R1||R2, or about 3.1kΩ. The circuit response is shown in Figure 3. Note the smooth transition between the two operating gains, as well as the linearity.

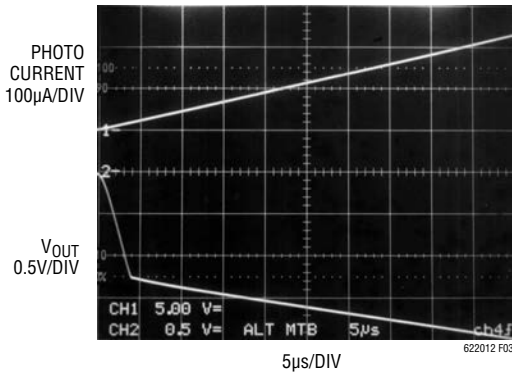

Figure 3. Stepped-Gain Photodiode Amplifier Response

### Single 3V Supply, 1MHz, 4th Order Butterworth Filter

The circuit shown in Figure 4 makes use of the low voltage operation and the wide bandwidth of the LT6221 to create a DC accurate 1MHz 4th order lowpass filter powered from a 3V supply. The amplifiers are configured in the inverting mode for the lowest distortion and the output can swing rail-to-rail for maximum dynamic range. Figure 5 displays the frequency response of the filter. Stopband attenuation is greater than 100dB at 50MHz.

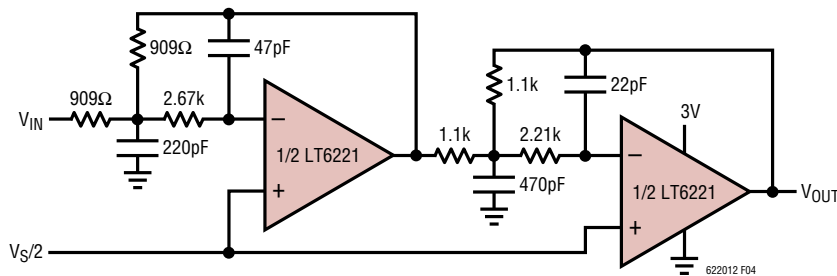

Figure 4. 3V, 1MHz, 4th Order Butterworth Filter

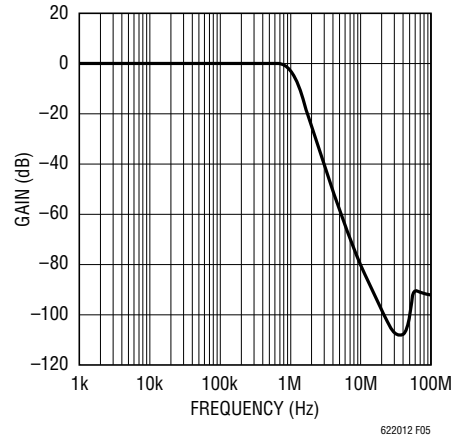

Figure 5. Frequency Response of Filter

### Differential-In/Differential-Out Amplifier

The circuit of Figure 6 shows the LT6222 applied as a buffered differential-in differential-out amplifier with a gain of 2. Op amps A and B are configured as simple unity-gain buffers, offering high input impedance to upstream circuitry. Resistors R1 and R2 perform an averaging function on the common mode input voltage and R3 attenuates it by a factor of 2/3 and references it to the voltage source  $V_{OCM}$ . The resultant voltage,  $V_{MID} = 2/3 \cdot V_{ICM}$ , is placed at the noninverting inputs of op amps C and D. The other four resistors set gains of +3 from the noninverting input and -2 through the inverting path. Thus the output voltage of the upper path is:

$$\begin{aligned} -OUT &= 3 \cdot (2/3 \cdot V_{ICM} + 1/3 \cdot V_{OCM}) - 2 \\ &\quad \cdot (V_{ICM} + V_{DIFF}/2) \\ &= 2V_{ICM} + V_{OCM} - 2V_{ICM} - V_{DIFF} \\ &= V_{OCM} - V_{DIFF} \end{aligned}$$



## TYPICAL APPLICATIONS

and the output of the lower path is:

$$\begin{aligned}
 +\text{OUT} &= 3 \cdot (2/3 \cdot V_{\text{ICM}} + 1/3 \cdot V_{\text{OCM}}) - 2 \\
 &\quad \cdot (V_{\text{ICM}} - V_{\text{DIFF}}/2) \\
 &= 2V_{\text{ICM}} + V_{\text{OCM}} - 2V_{\text{ICM}} + V_{\text{DIFF}} \\
 &= V_{\text{OCM}} + V_{\text{DIFF}}
 \end{aligned}$$

Note that the input common mode voltage does not appear in the output as either a common mode or a difference mode term. However the voltage  $V_{\text{OCM}}$  does appear in the output terms, and with the same polarity, so it sets up the output DC level. Also, the differential input voltage  $V_{\text{DIFF}}$  appears fully at both outputs with opposite polarity,

giving rise to the effective differential gain of 2. Calculations show that using 1% resistors gives worst-case input common mode feedthrough better than  $-31\text{dB}$ , whether looking at the output common mode or difference mode. Considering the  $6\text{dB}$  of gain, worst-case common mode rejection ratio is  $37\text{dB}$ . (Remember this is assuming 1% resistors. Of course, this can be improved with more precise resistors.) Results achieved on the bench with typical 1% resistors showed  $67\text{dB}$  of CMRR at low frequency and  $40\text{dB}$  CMRR at  $1\text{MHz}$ . Gains other than 2 can be achieved by setting  $R3 = \alpha \cdot (R1 || R2)$ ,  $R5 = \alpha \cdot R4$  and  $R7 = \alpha \cdot R6$  where gain =  $\alpha$ .

## PACKAGE DESCRIPTION

Please refer to <http://www.linear.com/designtools/packaging/> for the most recent package drawings.

**DD Package**  
**8-Lead Plastic DFN (3mm × 3mm)**  
 (Reference LTC DWG # 05-08-1698 Rev C)

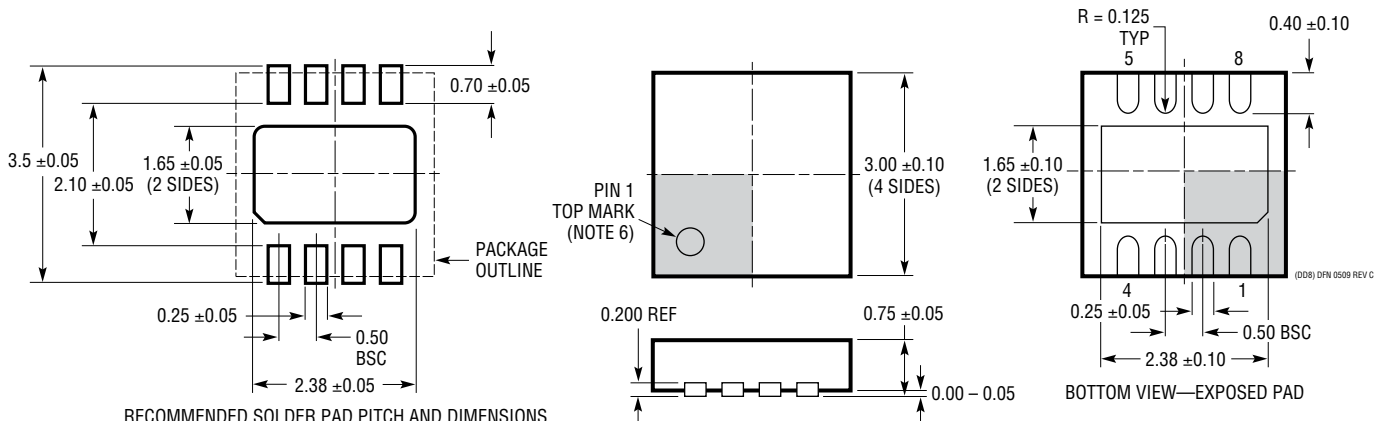

RECOMMENDED SOLDER PAD PITCH AND DIMENSIONS  
 APPLY SOLDER MASK TO AREAS THAT ARE NOT SOLDERED

- NOTE:
1. DRAWING TO BE MADE A JEDEC PACKAGE OUTLINE M0-229 VARIATION OF (WEED-1)
  2. DRAWING NOT TO SCALE
  3. ALL DIMENSIONS ARE IN MILLIMETERS
  4. DIMENSIONS OF EXPOSED PAD ON BOTTOM OF PACKAGE DO NOT INCLUDE MOLD FLASH. MOLD FLASH, IF PRESENT, SHALL NOT EXCEED 0.15mm ON ANY SIDE
  5. EXPOSED PAD SHALL BE SOLDER PLATED
  6. SHADED AREA IS ONLY A REFERENCE FOR PIN 1 LOCATION ON TOP AND BOTTOM OF PACKAGE

## PACKAGE DESCRIPTION

Please refer to <http://www.linear.com/designtools/packaging/> for the most recent package drawings.

### S5 Package 5-Lead Plastic TSOT-23 (Reference LTC DWG # 05-08-1635)

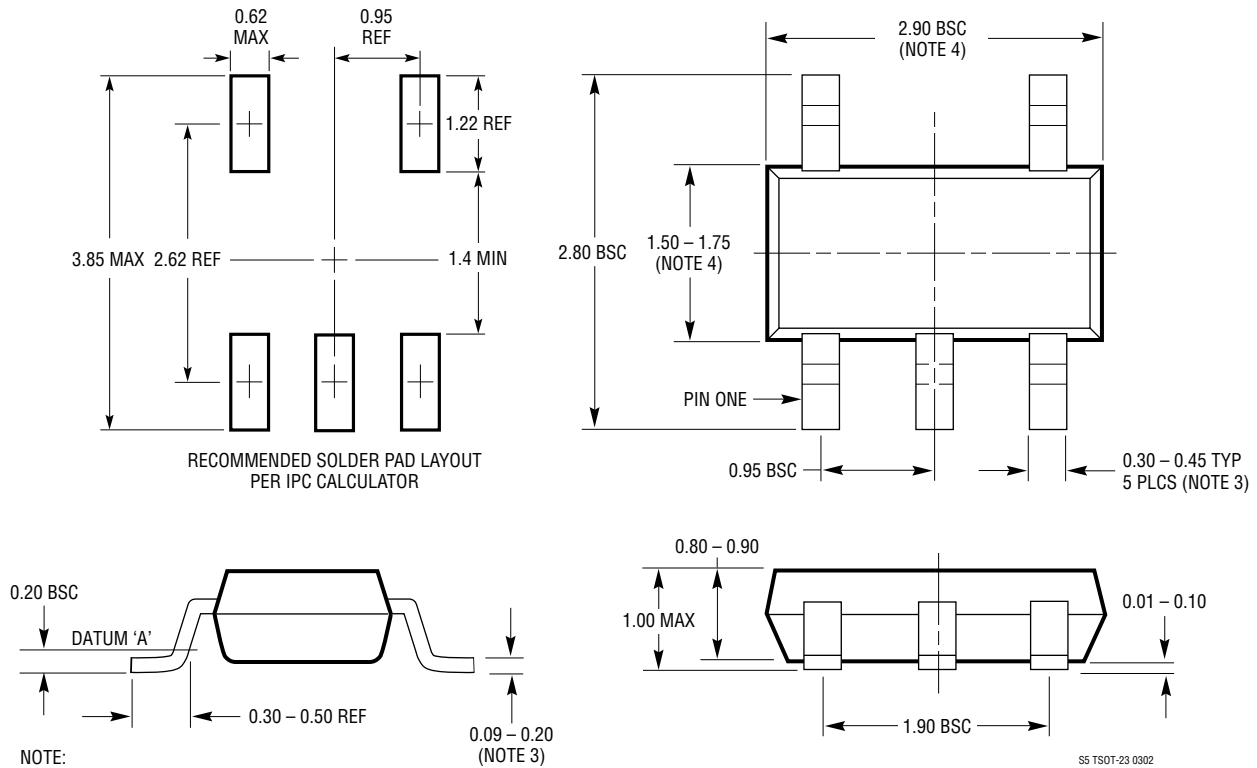

# PACKAGE DESCRIPTION

Please refer to <http://www.linear.com/designtools/packaging/> for the most recent package drawings.

## S8 Package 8-Lead Plastic Small Outline (Narrow .150 Inch) (Reference LTC DWG # 05-08-1610 Rev G)

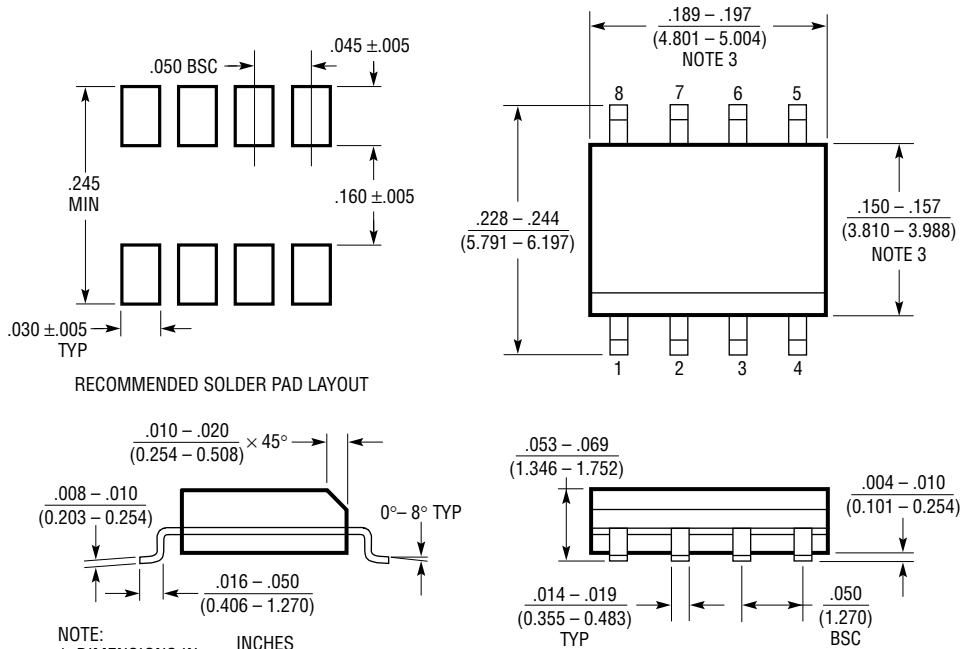

- NOTE:
1. DIMENSIONS IN INCHES (MILLIMETERS)
  2. DRAWING NOT TO SCALE
  3. THESE DIMENSIONS DO NOT INCLUDE MOLD FLASH OR PROTRUSIONS. MOLD FLASH OR PROTRUSIONS SHALL NOT EXCEED  $.006''$  ( $0.15\text{mm}$ )
  4. PIN 1 CAN BE BEVEL EDGE OR A DIMPLE

S08 REV G 0212

## PACKAGE DESCRIPTION

Please refer to <http://www.linear.com/designtools/packaging/> for the most recent package drawings.

### GN Package 16-Lead Plastic SSOP (Narrow .150 Inch) (Reference LTC DWG # 05-08-1641 Rev B)

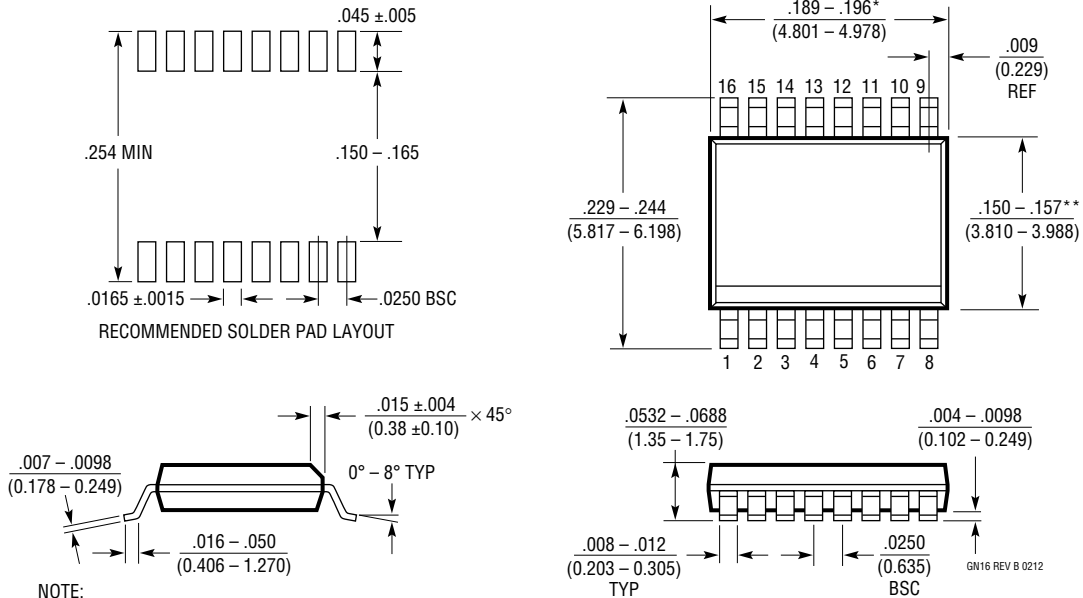

**NOTE:**

1. CONTROLLING DIMENSION: INCHES
2. DIMENSIONS ARE IN  $\frac{\text{INCHES}}{\text{(MILLIMETERS)}}$
3. DRAWING NOT TO SCALE
4. PIN 1 CAN BE BEVEL EDGE OR A DIMPLE

\*DIMENSION DOES NOT INCLUDE MOLD FLASH. MOLD FLASH SHALL NOT EXCEED 0.006" (0.152mm) PER SIDE

\*\*DIMENSION DOES NOT INCLUDE INTERLEAD FLASH. INTERLEAD FLASH SHALL NOT EXCEED 0.010" (0.254mm) PER SIDE

**REVISION HISTORY** (Revision history begins at Rev B)

REV	DATE	DESCRIPTION	PAGE NUMBER
B	05/14	Added $V_{OUT}$ information to Typical Application.	1
		Updated the Order Information table.	2
C	05/15	Updated Order Information table to reflect Specified Temperature Range	2

## TYPICAL APPLICATION

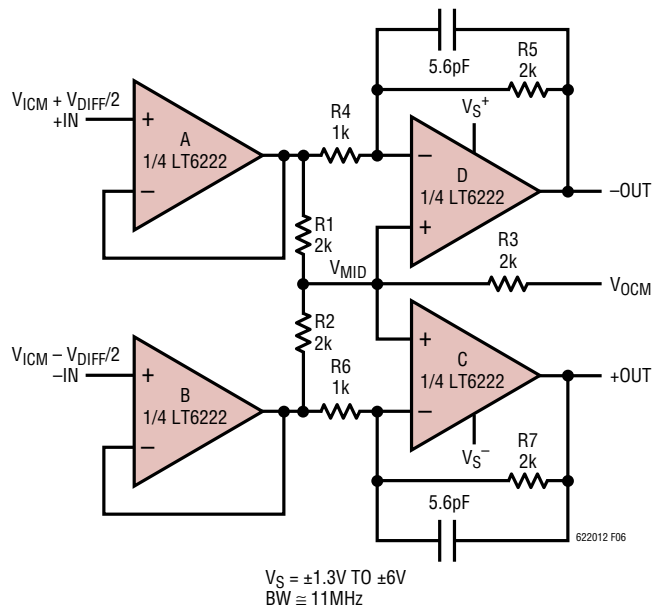

Figure 6. Buffered Gain of 2 Differential-In/Differential-Out Amplifier

## RELATED PARTS

PART NUMBER	DESCRIPTION	COMMENTS
<a href="#">LT1498/LT1499</a>	Dual/Quad 10MHz, 6V/μs Rail-to-Rail Input/Output C <sub>LOAD</sub> Op Amps	High DC Accuracy, 475μV V <sub>OS(MAX)</sub> Max Supply Current 2.2mA/Amp, Wide Supply Range, 2.2V to 30V
<a href="#">LT1800/LT1801/LT1802</a>	Single/Dual/Quad 80MHz, 25V/μs, Low Power Rail-to-Rail Input/Output Precision Op Amps	350μV V <sub>OS(MAX)</sub> , 250nA I <sub>BIAS(MAX)</sub> , Max Supply Current 2mA/Amp
<a href="#">LT1803/LT1804/LT1805</a>	Single/Dual/Quad 85MHz, 100V/μs Rail-to-Rail Input/Output Op Amps	2mV V <sub>OS(MAX)</sub> , Max Supply Current 3mA/Amp
<a href="#">LT1806/LT1807</a>	Single/Dual 325MHz, 140V/μs Rail-to-Rail Input/Output Op Amps	High DC Accuracy, 550μV V <sub>OS(MAX)</sub> Max Low Noise 3.5nV/√Hz Low Distortion -80dBc at 5MHz, Power Down (LT1806)
<a href="#">LT1809/LT1810</a>	Single/Dual 180MHz, Rail-to-Rail Input/Output Op Amps	350V/μs Slew Rate, Low Distortion -90dBc at 5MHz, Power Down (LT1809)

# Mouser Electronics

Authorized Distributor

Click to View Pricing, Inventory, Delivery & Lifecycle Information:

## [Analog Devices Inc.:](#)

[LT6220IS8#PBF](#) [LT6221CS8#TRPBF](#) [LT6221IDD#TR](#) [LT6222IGN](#) [LT6220CS5#TRPBF](#) [LT6221CDD](#)  
[LT6221CDD#TRPBF](#) [LT6221IS8#PBF](#) [LT6222CGN#PBF](#) [LT6222IGN#TRPBF](#) [LT6220CS8#TR](#) [LT6220IS5#TRM](#)  
[LT6221CDD#PBF](#) [LT6222IGN#PBF](#) [LT6220CS5#PBF](#) [LT6220CS8#TRPBF](#) [LT6220IS5#TRMPBF](#) [LT6220CS5#TR](#)  
[LT6221CS8](#) [LT6220IS5#TR](#) [LT6221CDD#TR](#) [LT6221IS8#TR](#) [LT6221IS8](#) [LT6221IS8#TRPBF](#) [LT6222CGN#TR](#)  
[LT6220CS8](#) [LT6220IS8#TR](#) [LT6221CS8#PBF](#) [LT6220IS5#TRPBF](#) [LT6220CS5#TRMPBF](#) [LT6222CGN](#)  
[LT6221CS8#TR](#) [LT6222CGN#TRPBF](#) [LT6220IS8#TRPBF](#) [LT6221IDD#PBF](#) [LT6220CS8#PBF](#) [LT6220IS5](#)  
[LT6220IS8](#) [LT6220CS5](#) [LT6220CS5#TRM](#) [LT6220IS5#PBF](#) [LT6222IGN#TR](#) [LT6221IDD#TRPBF](#) [LT6221IDD](#)