

THIS DRAWING IS UNPUBLISHED. RELEASED FOR PUBLICATION
 © COPYRIGHT - BY - TE CONNECTIVITY ALL RIGHTS RESERVED.

LOC	DIST	REVISIONS					
		P	LTR	DESCRIPTION	DATE	DWN	APVD
-	-	F		ECR-15-007519	19AUG2015	A.Q	D.Z
		G		ECR-15-015566	19OCT2015	A.Q	D.Z
		GI		ECR-17-017050	23NOV2017	C.X	D.Z

(2 POS.)

(6 POS.)

Notes:
 1 GENERAL TOLERANCE $\pm 0.3, \pm 3^\circ$
 2 MATERIAL: PA66 GF(UL94V-0)
 3 6-1971793-1 AS SHOWN ARE ONLY FOR P/N IN TABLE I
 4 APPLICABLE CONTACT P/N: 1971795-1
 5 RESTRICTED TO SPECIAL CUSTOMER (HAIER)

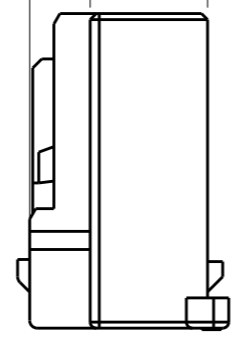
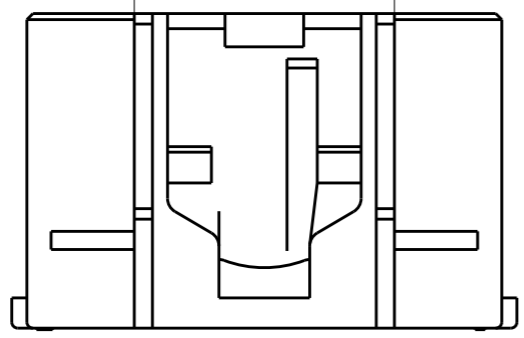
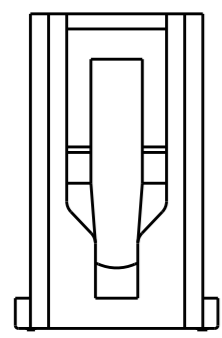
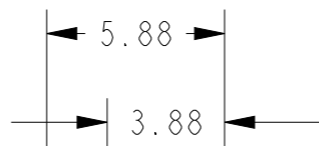
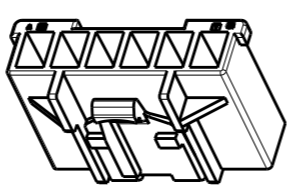
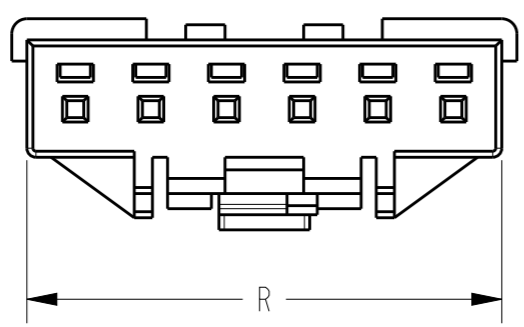
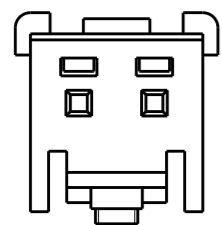
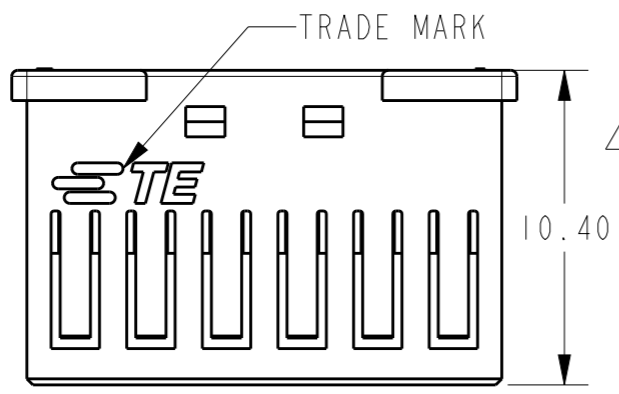
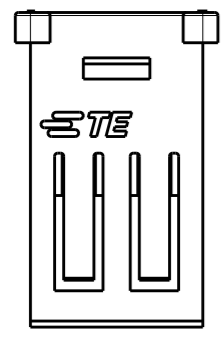

MATING CONN P/N		TABLE 1	R	M	P	N(POS.)	P/N
3-1971798-4	YELLOW	D	8.2	5	6.2	3	3-2232701-4
3-1971798-2	BLUE	B					3-2232701-2
2-1971798-1	NATURAL	A	5.7	2.5	5.7	2	2-2232701-1
6-1971798-X 6-1971800-X	NATURAL	NA	15.7	12.5	8.6	6	6-1971793-6
	BLACK	D					6-1971793-5
	YELLOW	D					6-1971793-4
	RED	C					6-1971793-3
	BLUE	B					6-1971793-2
	NATURAL	A					6-1971793-1
5-1971798-X 5-1971800-X	BLACK	D	13.2	10	8.6	5	5-1971793-5
	YELLOW	D					5-1971793-4
	RED	C					5-1971793-3
	BLUE	B					5-1971793-2
	NATURAL	A					5-1971793-1
	BLACK	D					4-1971793-5
4-1971798-X 4-1971800-X	YELLOW	D	10.7	7.5	7.4	4	4-1971793-4
	RED	C					4-1971793-3
	BLUE	B					4-1971793-2
	NATURAL	A					4-1971793-1
	BLACK	D					3-1971793-5
	YELLOW	D					3-1971793-4
3-1971798-X 3-1971800-X	RED	C	8.2	5	6.2	3	3-1971793-3
	BLUE	B					3-1971793-2
	NATURAL	A					3-1971793-1
	BLACK	D					2-1971793-5
	YELLOW	D					2-1971793-4
	RED	C					2-1971793-3
2-1971798-X 2-1971800-X	BLUE	B	5.7	2.5	5.7	2	2-1971793-2
	NATURAL	A					2-1971793-1

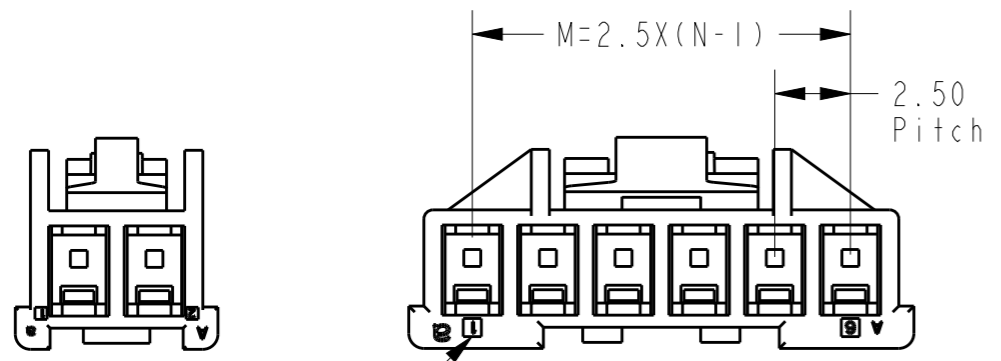

CIRCUIT NO. 1

THIS DRAWING IS A CONTROLLED DOCUMENT.		DWN HJ.Z 28MAY2013	 TE Connectivity	NAME NEXT GENERATION GRACE INERTIA CONNECTOR 2.5 PLUG HOUSING
DIMENSIONS: mm		CHK HJ.Z 28MAY2013		
TOLERANCES UNLESS OTHERWISE SPECIFIED:		APVD YH.M 28MAY2013		
0 PLC ± 0.3 1 PLC ± 0.3 2 PLC ± 0.13 3 PLC ± 0.013 4 PLC $\pm 0.000J$ ANGLES ± 3		PRODUCT SPEC 108-106077		
MATERIAL SEE NOTE		FINISH -	APPLICATION SPEC 114-106077	RESTRICTED TO -
		Customer Drawing	WEIGHT -	SCALE 5:1
			SIZE A3	SHEET 1 OF 3
			CAGE CODE -	REV GI
			DRAWING NO. C-1971793	

THIS DRAWING IS UNPUBLISHED.

RELEASED FOR PUBLICATION

20

© COPYRIGHT 20 BY -

ALL RIGHTS RESERVED.

LOC	DIST	REVISIONS					
		P	LTR	DESCRIPTION	DATE	DWN	APVD
-	-	-	-	SEE SHEET 1	-	-	-

7-1971793-1 AS SHOWN FOR P/N IN TABLE 2

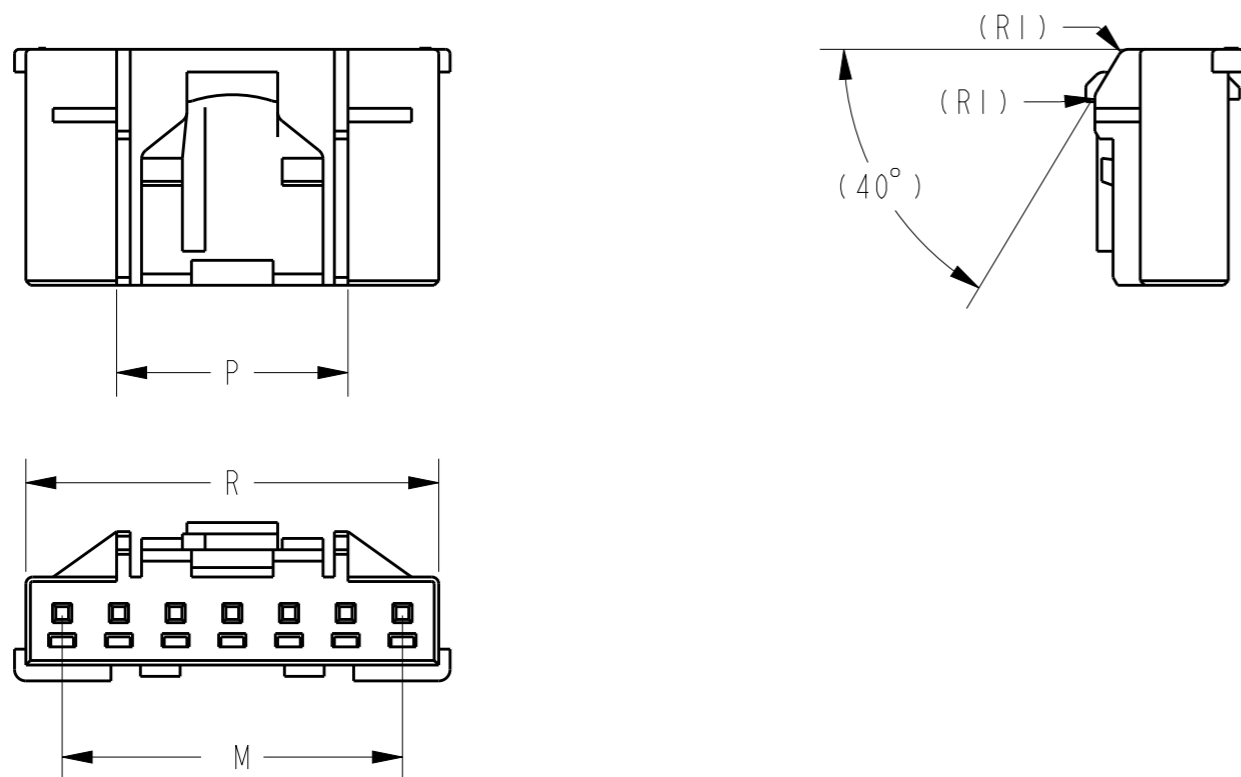

Notes:
 1 DIMENSIONS SHOWING IN SHEET 2 ARE ONLY FOR P/N IN TABLE 2
 2 DIMENSIONS NOT SHOWING IN SHEET 2 ARE THE SAME WITH DIMENSIONS IN SHEET 1

TABLE 2							
8-1971798-X 8-1971800-X	BLACK	D	20.7	17.5	10.2	8	8-1971793-5
	YELLOW	D					8-1971793-4
	RED	C					8-1971793-3
	BLUE	B					8-1971793-2
	NATURAL	A					8-1971793-1
7-1971798-X 7-1971800-X	BLACK	D	18.2	15	10.2	7	7-1971793-5
	YELLOW	D					7-1971793-4
	RED	C					7-1971793-3
	BLUE	B					7-1971793-2
	NATURAL	A					7-1971793-1
MATING CONN P/N	COLOR	KEYING	R	M	P	N(POS.)	P/N

THIS DRAWING IS A CONTROLLED DOCUMENT.		DWN ANNIE QIAN 08MAY2015	 TE Connectivity	
DIMENSIONS: mm		CHK ANNIE QIAN 08MAY2015		
TOLERANCES UNLESS OTHERWISE SPECIFIED		APVD DANIEL AHGN 08MAY2015	NAME NEXT GENERATION GRACE INERTIA CONNECTOR 2.5 PLUG HOUSING	
0 PLC ±.3 1 PLC ±.3 2 PLC ±0.13 3 PLC ±0.013 4 PLC ±0.000J ANGLES ±3		PRODUCT SPEC 108-106077	SIZE A3	CAGE CODE -
MATERIAL -		APPLICATION SPEC 114-106077	DRAWING NO C-1971793	RESTRICTED TO -
FINISH -		WEIGHT -	SCALE 5:1	
		CUSTOMER DRAWING		SHEET 2 OF 3
				REV G1

THIS DRAWING IS UNPUBLISHED.

RELEASED FOR PUBLICATION

20

© COPYRIGHT 20 BY -

ALL RIGHTS RESERVED.

LOC -

DIST -

REVISIONS

P	LTR	DESCRIPTION	DATE	DWN	APVD
-	-	SEE SHEET 1	-	-	-

KEY A

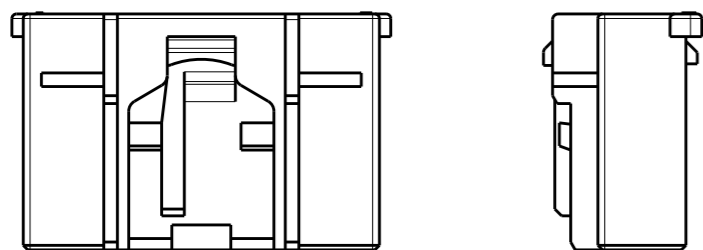

KEY B

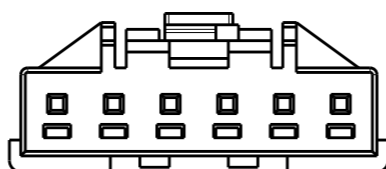
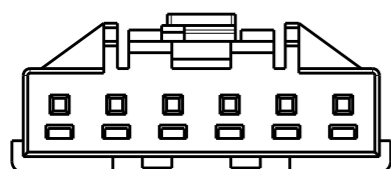
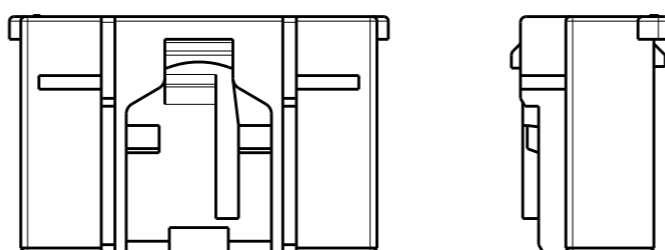

FOR 6-1971793-6 NO KEY

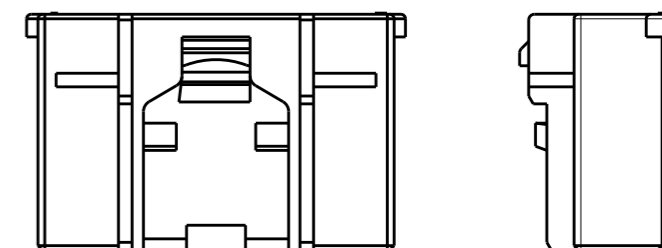

KEY C

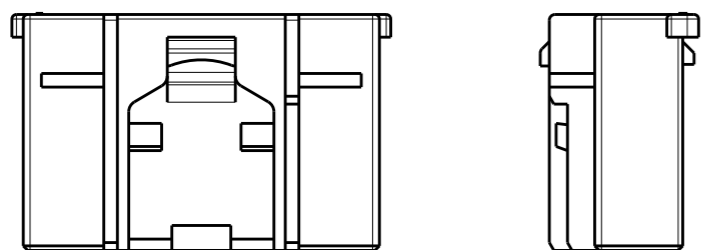

KEY D

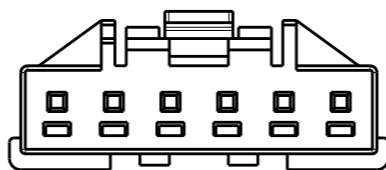
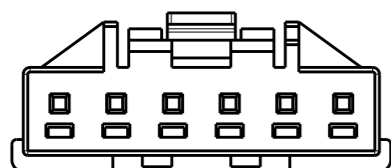
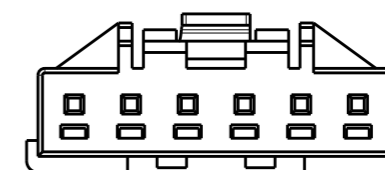
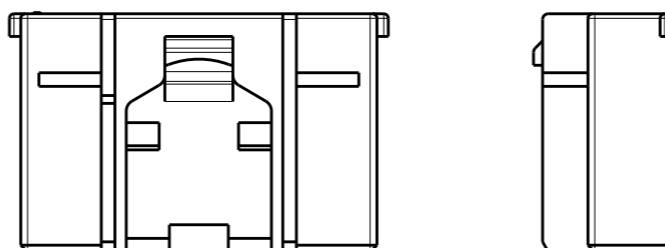

KEY TYPE 6-1971793-1 AS SHOWN

THIS DRAWING IS A CONTROLLED DOCUMENT.

DIMENSIONS:
mm

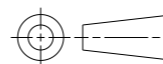

TOLERANCES UNLESS OTHERWISE SPECIFIED

- 0 PLC ±0.3
- 1 PLC ±0.3
- 2 PLC ±0.13
- 3 PLC ±0.013
- 4 PLC ±0.0001
- ANGLES ±3

MATERIAL -

FINISH -

DWN 15MAY2015

ANNIE QIAN

CHK 15MAY2015

ANNIE QIAN

APVD 15MAY2015

DANIEL ZHANG

PRODUCT SPEC

108-106077

APPLICATION SPEC

114-106077

WEIGHT -

CUSTOMER DRAWING



TE Connectivity

NAME
NEXT GENERATION
GRACE INERTIA CONNECTOR 2.5
PLUG HOUSING

SIZE A3 CAGE CODE - DRAWING NO. ©-1971793 RESTRICTED TO -

SCALE 5:1 SHEET 3 OF 3 REV G1

Mouser Electronics

Authorized Distributor

Click to View Pricing, Inventory, Delivery & Lifecycle Information:

[TE Connectivity:](#)

[3-1971793-1](#)