

4

3

2

1

THIS DRAWING IS UNPUBLISHED. RELEASED FOR PUBLICATION 2009
 © COPYRIGHT 2009 ALL RIGHTS RESERVED.

LOC	DIST	REVISIONS				
P	LTR	DESCRIPTION	DATE	DWN	APVD	
E	B	BA1	REVISED PER ECO-11-005150	29MAR2011	RK HMR	

SERIES 3650-1J, 3650-2A AS SHOWN

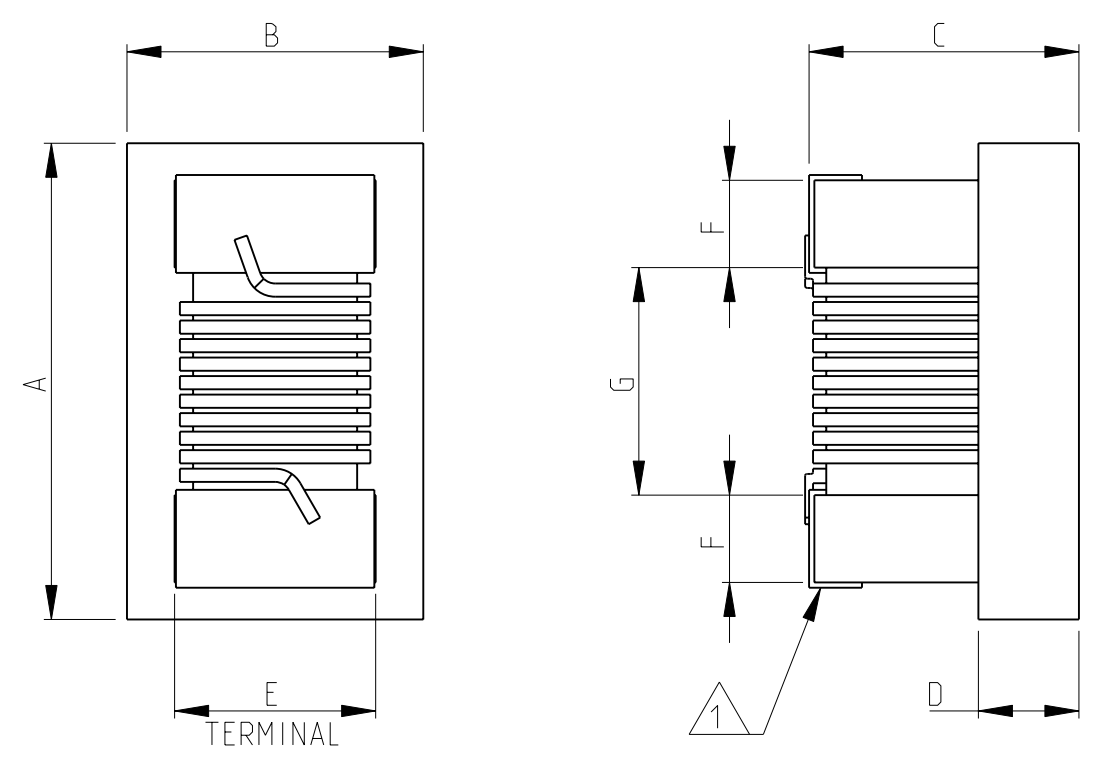

- 1 TERMINAL WRAPAROUND APPROX 0.007" (0.18mm) BOTH ENDS
- 2 AVAILABLE IN 2 DIFFERENT SERIES
- 3 FOR FURTHER INFORMATION SEE DATA SHEET FOR 3650 SERIES-LOW INDUCTANCE, HIGH FREQUENCY CHIP INDUCTOR

RoHS Compliant

RECOMMENDED LAND PATTERN FOR 3650-2A, 3650-1J SERIES

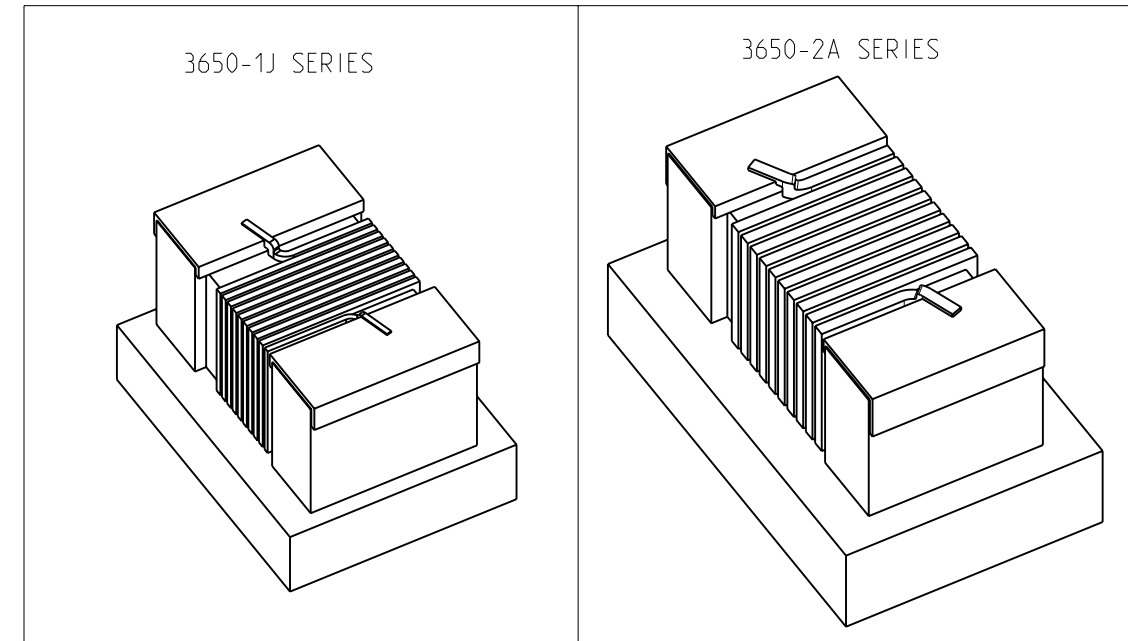
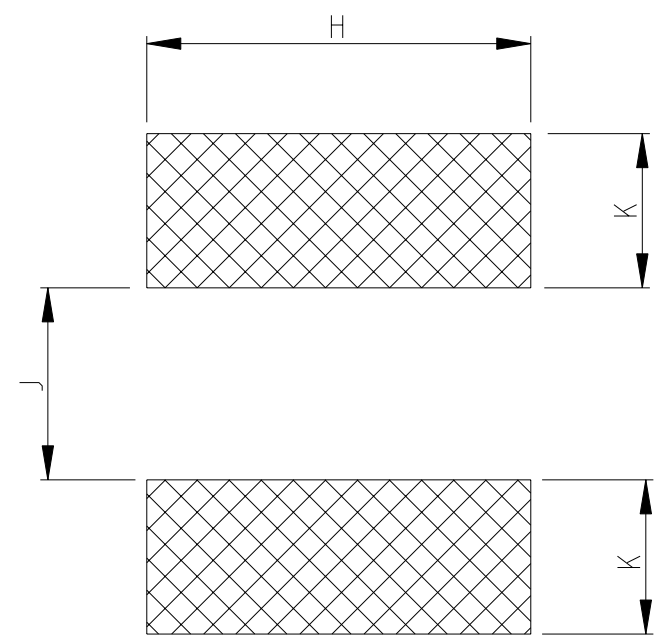

	A Max.	B Max.	C Max.	D ref	E	F	G	H	K	J
3650-1J	1.80	1.12	1.02	0.38	0.76	0.33	0.86	1.02	0.64	0.64
3650-2A	2.29	1.73	1.52	0.51	1.27	0.51	1.02	1.78	1.02	0.76
SERIES	A Max.	B Max.	C Max.	D ref	E	F	G	H	K	J

THIS DRAWING IS A CONTROLLED DOCUMENT.		DWN	SUBHASH.M 03-AUG-09		 TE Connectivity
DIMENSIONS: mm		CHK	ALLAN.P 03-AUG-09		
TOLERANCES UNLESS OTHERWISE SPECIFIED:		APVD	STEPHEN.P 03-AUG-09		
0 PLC ± 0.2 1 PLC ± 0.1 2 PLC ± - 3 PLC ± - 4 PLC ± - ANGLES ± 5°		PRODUCT SPEC	-		
MATERIAL -		FINISH	-		LOW INDUCTANCE, HIGH FREQUENCY CHIP INDUCTOR SERIES 3650
		WEIGHT	-		SIZE A3 CAGE CODE 00779 DRAWING NO 1624113 RESTRICTED TO -
		CUSTOMER DRAWING			SCALE NTS SHEET 1 OF 1 REV BA1

Mouser Electronics

Authorized Distributor

Click to View Pricing, Inventory, Delivery & Lifecycle Information:

[TE Connectivity:](#)

[36502AR10JTDG](#)