

Click [here](#) for production status of specific part numbers.

## MAX6070/MAX6071

## Low-Noise, High-Precision Series Voltage References

### General Description

The MAX6070/MAX6071 offer a very low noise and low-drift voltage reference in a small 6-pin SOT23 package. These devices provide a  $1/f$  noise voltage of only  $4.8\mu\text{V}_{\text{P-P}}$  at an output voltage of 2.5V, with a temperature drift of  $6\text{ppm}/^\circ\text{C}$  (max). The devices consume  $150\mu\text{A}$  of supply current and can sink and source up to 10mA of load current. The low-drift and low-noise specifications enable enhanced system accuracy, making these devices ideal for high-precision industrial applications. The MAX6070 offers a noise filter option for wideband applications.

The devices are available in a 6-pin SOT23 package and are specified over the extended industrial temperature range of  $-40^\circ\text{C}$  to  $+125^\circ\text{C}$ . The 2.5V options are also available in a 6-bump 0.78mm x 1.41mm wafer-level package (WLP).

### Applications

- High-Accuracy Industrial and Process Control
- Precision Instrumentation
- High-Resolution ADCs and DACs
- Precision Current Sources
- Automotive

### Benefits and Features

- 6-Pin SOT23 Package Reduces System Board Space
- Stable Performance Over Temperature and Time Improves System Accuracy
  - High  $\pm 0.04\%$  Initial Accuracy
  - Low  $1.5\text{ppm}/^\circ\text{C}$  (typ),  $6\text{ppm}/^\circ\text{C}$  (max) Temperature Drift
  - Low  $4.8\mu\text{V}_{\text{P-P}}$  Noise (0.1Hz to 10Hz) at 2.5V
  - Low 200mV Dropout Voltage
  - High 85dB Ripple Rejection
- Low  $150\mu\text{A}$  Supply Current Reduces Power Consumption
- Filter Option Lowers High-Frequency Noise
- Output Options: 1.25V, 1.8V, 2.048V, 2.5V, 3.0V, 3.3V, 4.096V, and 5.0V Cover Common Voltage Levels for a Wide Variety of Applications
- 0.78mm x 1.41mm WLP with 0.35mm Bump Spacing
- AEC-Q100 Qualified (Refer to [Ordering Information](#))

[Ordering Information](#) and [Selector Guide](#) appears at end of data sheet.

### Typical Operating Circuits

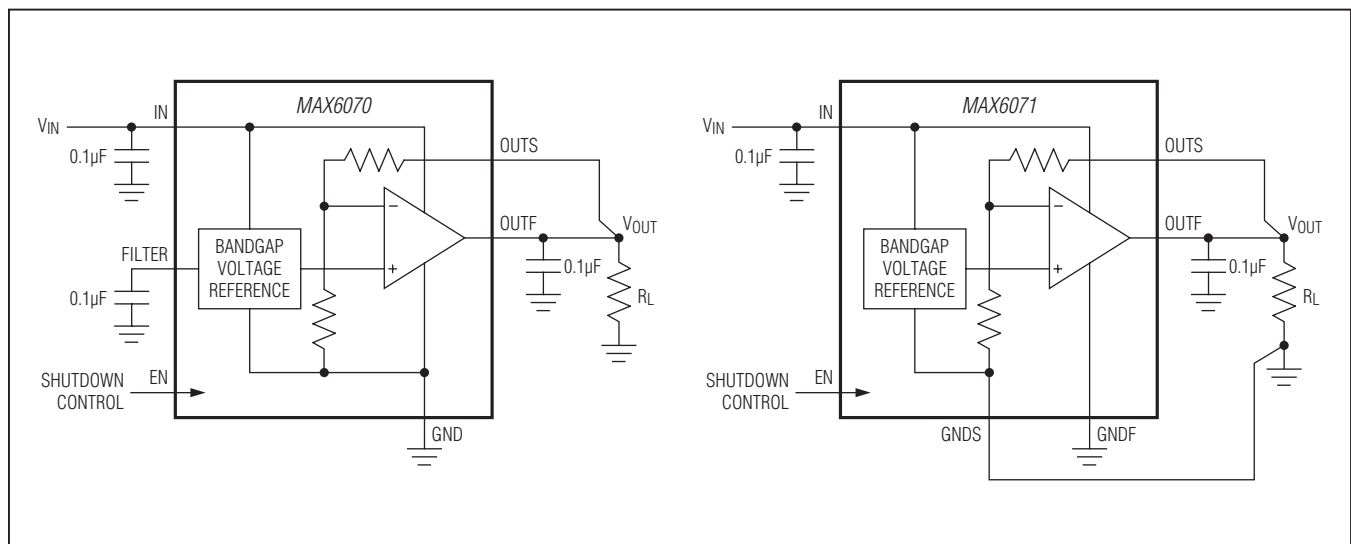

**Absolute Maximum Ratings**

OUTF to GNDS, GNDF, GND.....	-0.3V to the lower of ( $V_{IN} + 0.3V$ ), +6V	Continuous Power Dissipation ( $T_A = +70^{\circ}C$ )	
OUTS to GNDS, GNDF, GND .....	-0.3V to +6V	SOT23 (derate 4.3mW/ $^{\circ}C$ above +70 $^{\circ}C$ ).....	347.8mW
IN to GNDS, GNDF, GND .....	-0.3V to +6V	WLP (derate 10.2mW/ $^{\circ}C$ above 70 $^{\circ}C$ .....	816mW
EN to GNDS, GNDF, GND .....	-0.3V to +6V	Operating Temperature Range .....	-40 $^{\circ}C$ to +125 $^{\circ}C$
FILTER to GND.....	-0.3V to the lower of ( $V_{IN} + 0.3V$ ), +6V	Junction Temperature .....	+150 $^{\circ}C$
GNDS to GNDF .....	-0.3V to +0.3V	Storage Temperature Range.....	-65 $^{\circ}C$ to +150 $^{\circ}C$
		Soldering Temperature (reflow) .....	+260 $^{\circ}C$
		Lead Temperature (soldering, 10s) .....	+300 $^{\circ}C$

Stresses beyond those listed under "Absolute Maximum Ratings" may cause permanent damage to the device. These are stress ratings only, and functional operation of the device at these or any other conditions beyond those indicated in the operational sections of the specifications is not implied. Exposure to absolute maximum rating conditions for extended periods may affect device reliability.

**Package Information**

**6 SOT23**

PACKAGE CODE	U6+5/U6+5A
Outline Number	<a href="#">21-0058</a>
Land Pattern Number	<a href="#">90-0175</a>
<b>Thermal Resistance, Multi-Layer Board:</b>	
Junction to Ambient ( $\theta_{JA}$ )	230 $^{\circ}C/W$
Junction to Case ( $\theta_{JC}$ )	76 $^{\circ}C/W$

**6 Thin WLP**

PACKAGE CODE	N60B1+1
Outline Number	<a href="#">21-0744</a>
Land Pattern Number	Refer to <a href="#">Application Note 1891</a>
<b>Thermal Resistance, Multi-Layer Board:</b>	
Junction to Ambient ( $\theta_{JA}$ )	98 $^{\circ}C/W$

For the latest package outline information and land patterns (footprints), go to [www.maximintegrated.com/packages](http://www.maximintegrated.com/packages). Note that a "+", "#", or "-" in the package code indicates RoHS status only. Package drawings may show a different suffix character, but the drawing pertains to the package regardless of RoHS status.

Package thermal resistances were obtained using the method described in JEDEC specification JESD51-7, using a four-layer board. For detailed information on package thermal considerations, refer to [www.maximintegrated.com/thermal-tutorial](http://www.maximintegrated.com/thermal-tutorial).

**Electrical Characteristics—MAX607\_\_AUT12 (V<sub>OUT</sub> = 1.250V)**(V<sub>IN</sub> = +5.0V, I<sub>OUT</sub> = 0mA, C<sub>OUT</sub> = 0.1μF, T<sub>A</sub> = -40°C to +125°C, unless otherwise noted. Typical values are at T<sub>A</sub> = +25°C.) (Note 1)

PARAMETER	SYMBOL	CONDITIONS	MIN	TYP	MAX	UNITS
<b>OUTPUT</b>						
Output Voltage Accuracy		MAX6070A/MAX6071A, T <sub>A</sub> = +25°C	-0.04		+0.04	%
		MAX6070B/MAX6071B, T <sub>A</sub> = +25°C	-0.08		+0.08	
Output Voltage Temperature Drift (Note 2)	TCV <sub>OUT</sub>	MAX6070A/MAX6071A		1.5	6	ppm/ °C
		MAX6070B/MAX6071B		2.0	8	
Line Regulation		Over specified V <sub>IN</sub> range	T <sub>A</sub> = +25°C	13	100	μV/V
				T <sub>A</sub> = T <sub>MIN</sub> to T <sub>MAX</sub>		
Load Regulation		0mA < I <sub>OUT</sub> < 10mA, sink		70	150	μV/mA
		0mA < I <sub>OUT</sub> < 10mA, source		100	150	
Output Current	I <sub>OUT</sub>		-10		+10	mA
Short-Circuit Current	I <sub>SC</sub>	Sourcing to ground		25		mA
		Sinking from V <sub>IN</sub>		25		
Long-Term Stability		1000 hours at T <sub>A</sub> = +25°C		35		ppm
Thermal Hysteresis		(Note 4)		85		ppm
<b>DYNAMIC CHARACTERISTICS</b>						
Noise Voltage	e <sub>OUT</sub>	1/f noise, 0.1Hz to 10Hz, C <sub>OUT</sub> = 0.1μF		3.6		μV <sub>P-P</sub>
		MAX6071 thermal noise, 10Hz to 10kHz, C <sub>OUT</sub> = 0.1μF		5.0		μV <sub>RMS</sub>
		MAX6070 thermal noise, 10Hz to 10kHz, C <sub>OUT</sub> = 0.1μF, C <sub>FILTER</sub> = 0.1μF		2.5		
Ripple Rejection		Frequency = 60Hz		100		dB
Turn-On Settling Time	t <sub>R</sub>	Settling to 0.01%, C <sub>OUT</sub> = 0.1μF	MAX6070, C <sub>FILTER</sub> = 0.1μF	6		ms
			MAX6071		20	
Enable Settling Time	t <sub>EN</sub>	Settling to 0.01%, C <sub>OUT</sub> = 0.1μF	MAX6070, C <sub>FILTER</sub> = 0.1μF	6		ms
			MAX6071		60	
Capacitive-Load Stability Range		I <sub>OUT</sub> ≤ 10mA	0.1		10	μF
<b>INPUT</b>						
Supply Voltage	V <sub>IN</sub>	Guaranteed by line regulation	2.7		5.5	V
Quiescent Supply Current	I <sub>IN</sub>	T <sub>A</sub> = +25°C		130	200	μA
		T <sub>A</sub> = T <sub>MIN</sub> to T <sub>MAX</sub>			260	
Shutdown Supply Current	I <sub>SD</sub>				6	μA
<b>ENABLE</b>						
Enable Input Current	I <sub>EN</sub>		-1		+1	μA
Enable Logic-High	V <sub>IH</sub>		0.7 × V <sub>IN</sub>			V
Enable Logic-Low	V <sub>IL</sub>				0.3 × V <sub>IN</sub>	

**Electrical Characteristics—MAX607\_\_AUT18 (V<sub>OUT</sub> = 1.800V)**(V<sub>IN</sub> = +5.0V, I<sub>OUT</sub> = 0mA, C<sub>OUT</sub> = 0.1μF, T<sub>A</sub> = -40°C to +125°C, unless otherwise noted. Typical values are at T<sub>A</sub> = +25°C.) (Note 1)

PARAMETER	SYMBOL	CONDITIONS	MIN	TYP	MAX	UNITS
<b>OUTPUT</b>						
Output Voltage Accuracy		MAX6070A/MAX6071A, T <sub>A</sub> = +25°C	-0.04		+0.04	%
		MAX6070B/MAX6071B, T <sub>A</sub> = +25°C	-0.08		+0.08	
Output Voltage Temperature Drift (Note 2)	TCV <sub>OUT</sub>	MAX6070A/MAX6071A		1.5	6	ppm/°C
		MAX6070B/MAX6071B		2.0	8	
Line Regulation		Over specified V <sub>IN</sub> range	T <sub>A</sub> = +25°C	35	150	μV/V
			T <sub>A</sub> = T <sub>MIN</sub> to T <sub>MAX</sub>			
Load Regulation		0mA < I <sub>OUT</sub> < 10mA, sink		120	200	μV/mA
		0mA < I <sub>OUT</sub> < 10mA, source		120	200	
Output Current	I <sub>OUT</sub>		-10		+10	mA
Short-Circuit Current	I <sub>SC</sub>	Sourcing to ground		25		mA
		Sinking from V <sub>IN</sub>		25		
Long-Term Stability		1000 hours at T <sub>A</sub> = +25°C		35		ppm
Thermal Hysteresis		(Note 4)		85		ppm
<b>DYNAMIC CHARACTERISTICS</b>						
Noise Voltage	e <sub>OUT</sub>	1/f noise, 0.1Hz to 10Hz, C <sub>OUT</sub> = 0.1μF		6		μV <sub>P-P</sub>
		MAX6071 thermal noise, 10Hz to 10kHz C <sub>OUT</sub> = 0.1μF		7		μV <sub>RMS</sub>
		MAX6070 thermal noise, 10Hz to 10kHz C <sub>OUT</sub> = 0.1μF, C <sub>FILTER</sub> = 0.1μF		5		
Ripple Rejection		Frequency = 60Hz		89		dB
Turn-On Settling Time	t <sub>R</sub>	Settling to 0.01% C <sub>OUT</sub> = 0.1μF	MAX6070 C <sub>FILTER</sub> = 0.1μF	6		ms
			MAX6071		32	
Enable Settling Time	t <sub>EN</sub>	Settling to 0.01% C <sub>OUT</sub> = 0.1μF	MAX6070 C <sub>FILTER</sub> = 0.1μF	6		ms
			MAX6071		60	
Capacitive-Load Stability Range		I <sub>OUT</sub> ≤ 10mA	0.1		10	μF
<b>INPUT</b>						
Supply Voltage	V <sub>IN</sub>	Guaranteed by line regulation	2.7		5.5	V
Quiescent Supply Current	I <sub>IN</sub>	T <sub>A</sub> = +25°C		130	200	μA
		T <sub>A</sub> = T <sub>MIN</sub> to T <sub>MAX</sub>			260	
Shutdown Supply Current	I <sub>SD</sub>				6	μA
<b>ENABLE</b>						
Enable Input Current	I <sub>EN</sub>		-1		1	μA
Enable Logic-High	V <sub>IH</sub>		0.7 × V <sub>IN</sub>			V
Enable Logic-Low	V <sub>IL</sub>				0.3 × V <sub>IN</sub>	

**Electrical Characteristics—MAX607\_\_AUT21 (V<sub>OUT</sub> = 2.048V)**(V<sub>IN</sub> = +5.0V, I<sub>OUT</sub> = 0mA, C<sub>OUT</sub> = 0.1μF, T<sub>A</sub> = -40°C to +125°C, unless otherwise noted. Typical values are at T<sub>A</sub> = +25°C.) (Note 1)

PARAMETER	SYMBOL	CONDITIONS	MIN	TYP	MAX	UNITS
<b>OUTPUT</b>						
Output Voltage Accuracy		MAX6070A/MAX6071A, T <sub>A</sub> = +25°C	-0.04		+0.04	%
		MAX6070B/MAX6071B, T <sub>A</sub> = +25°C	-0.08		+0.08	
Output Voltage Temperature Drift (Note 2)	TCV <sub>OUT</sub>	MAX6070A/MAX6071A		1.5	6	ppm/°C
		MAX6070B/MAX6071B		2.0	8	
Line Regulation		Over specified V <sub>IN</sub> range	T <sub>A</sub> = +25°C	50	180	μV/V
			T <sub>A</sub> = T <sub>MIN</sub> to T <sub>MAX</sub>			
Load Regulation		0mA < I <sub>OUT</sub> < 10mA, sink		135	225	μV/mA
		0mA < I <sub>OUT</sub> < 10mA, source		135	225	
Output Current	I <sub>OUT</sub>		-10		+10	mA
Short-Circuit Current	I <sub>SC</sub>	Sourcing to ground		25		mA
		Sinking from V <sub>IN</sub>		25		
Long-Term Stability		1000 hours at T <sub>A</sub> = +25°C		35		ppm
Thermal Hysteresis		(Note 4)		85		ppm
<b>DYNAMIC CHARACTERISTICS</b>						
Noise Voltage	e <sub>OUT</sub>	1/f noise, 0.1Hz to 10Hz, C <sub>OUT</sub> = 0.1μF		6.4		μV <sub>P-P</sub>
		MAX6071 thermal noise, 10Hz to 10kHz C <sub>OUT</sub> = 0.1μF		8.6		μV <sub>RMS</sub>
		MAX6070 thermal noise, 10Hz to 10kHz C <sub>OUT</sub> = 0.1μF, C <sub>FILTER</sub> = 0.1μF		6.3		
Ripple Rejection		Frequency = 60Hz		86		dB
Turn-On Settling Time	t <sub>R</sub>	Settling to 0.01% C <sub>OUT</sub> = 0.1μF	MAX6070 C <sub>FILTER</sub> = 0.1μF	6.2		ms
			MAX6071		25	
Enable Settling Time	t <sub>EN</sub>	Settling to 0.01% C <sub>OUT</sub> = 0.1μF	MAX6070 C <sub>FILTER</sub> = 0.1μF	6.2		ms
			MAX6071		65	
Capacitive-Load Stability Range		I <sub>OUT</sub> ≤ 10mA	0.1		10	μF
<b>INPUT</b>						
Supply Voltage	V <sub>IN</sub>	Guaranteed by line regulation	2.7		5.5	V
Quiescent Supply Current	I <sub>IN</sub>	T <sub>A</sub> = +25°C		130	200	μA
		T <sub>A</sub> = T <sub>MIN</sub> to T <sub>MAX</sub>			260	
Shutdown Supply Current	I <sub>SD</sub>				6	μA
<b>ENABLE</b>						
Enable Input Current	I <sub>EN</sub>		-1		+1	μA
Enable Logic-High	V <sub>IH</sub>		0.7 × V <sub>IN</sub>			V
Enable Logic-Low	V <sub>IL</sub>		0.3 × V <sub>IN</sub>			

**Electrical Characteristics—MAX607\_\_AUT25 (V<sub>OUT</sub> = 2.500V)**(V<sub>IN</sub> = +5.0V, I<sub>OUT</sub> = 0mA, C<sub>OUT</sub> = 0.1μF, T<sub>A</sub> = -40°C to +125°C, unless otherwise noted. Typical values are at T<sub>A</sub> = +25°C.) (Note 1)

PARAMETER	SYMBOL	CONDITIONS	MIN	TYP	MAX	UNITS	
<b>OUTPUT</b>							
Output Voltage Accuracy		MAX6070A/MAX6071A, T <sub>A</sub> = +25°C	-0.04		+0.04	%	
		MAX6070B/MAX6071B, T <sub>A</sub> = +25°C	-0.08		+0.08		
Output Voltage Temperature Drift (Note 2)	TCV <sub>OUT</sub>	MAX6070A/MAX6071A		1.5	6	ppm/°C	
		MAX6070B/MAX6071B		2.0	8		
Line Regulation		Over specified V <sub>IN</sub> range	T <sub>A</sub> = +25°C		60	145	μV/V
			T <sub>A</sub> = T <sub>MIN</sub> to T <sub>MAX</sub>			175	
Load Regulation		0mA < I <sub>OUT</sub> < 10mA, sink		80	140	μV/mA	
		0mA < I <sub>OUT</sub> < 10mA, source		75	125		
Dropout Voltage		I <sub>OUT</sub> = 10mA, T <sub>A</sub> = T <sub>MIN</sub> to T <sub>MAX</sub> (Note 3)		110	230	mV	
Output Current	I <sub>OUT</sub>		-10		+10	mA	
Short-Circuit Current	I <sub>SC</sub>	Sourcing to ground		25		mA	
		Sinking from V <sub>IN</sub>		25			
Long-Term Stability		1000 hours at T <sub>A</sub> = +25°C		40		ppm	
Thermal Hysteresis		(Note 4)		85		ppm	
<b>DYNAMIC CHARACTERISTICS</b>							
Noise Voltage	e <sub>OUT</sub>	1/f noise, 0.1Hz to 10Hz, C <sub>OUT</sub> = 0.1μF		4.8		μV <sub>P-P</sub>	
		MAX6071 thermal noise, 10Hz to 10kHz, C <sub>OUT</sub> = 0.1μF		6		μV <sub>RMS</sub>	
		MAX6070 thermal noise, 10Hz to 10kHz, C <sub>OUT</sub> = 0.1μF, C <sub>FILTER</sub> = 0.1μF		3			
Noise Spectral Density		MAX6071 thermal noise, f = 1kHz, C <sub>OUT</sub> = 0.1μF		60		nV/√Hz	
		MAX6070 thermal noise, f = 1kHz, C <sub>OUT</sub> = 0.1μF, C <sub>FILTER</sub> = 0.1μF		30			
Ripple Rejection		Frequency = 60Hz		84		dB	
Turn-On Settling Time	t <sub>R</sub>	Settling to 0.01%, C <sub>OUT</sub> = 0.1μF	MAX6070, C <sub>FILTER</sub> = 0.1μF	10		ms	
			MAX6071		30		μs
Enable Settling Time	t <sub>EN</sub>	Settling to 0.01%, C <sub>OUT</sub> = 0.1μF	MAX6070, C <sub>FILTER</sub> = 0.1μF	10		ms	
			MAX6071		75		μs
Capacitive-Load Stability Range		I <sub>OUT</sub> ≤ 10mA	0.1		10	μF	
<b>INPUT</b>							
Supply Voltage	V <sub>IN</sub>	Guaranteed by line regulation	2.8		5.5	V	
Quiescent Supply Current	I <sub>IN</sub>	T <sub>A</sub> = +25°C		150	235	μA	
		T <sub>A</sub> = T <sub>MIN</sub> to T <sub>MAX</sub>			300		
Shutdown Supply Current	I <sub>SD</sub>			0.6	6	μA	

**Electrical Characteristics—MAX607\_\_AUT25 (V<sub>OUT</sub> = 2.500V) (continued)**(V<sub>IN</sub> = +5.0V, I<sub>OUT</sub> = 0mA, C<sub>OUT</sub> = 0.1μF, T<sub>A</sub> = -40°C to +125°C, unless otherwise noted. Typical values are at T<sub>A</sub> = +25°C.) (Note 1)

PARAMETER	SYMBOL	CONDITIONS	MIN	TYP	MAX	UNITS
<b>ENABLE/SHUTDOWN</b>						
Enable Input Current	I <sub>EN</sub>		-1		+1	μA
Enable Logic-High	V <sub>IH</sub>		0.7 × V <sub>IN</sub>			V
Enable Logic-Low	V <sub>IL</sub>		0.3 × V <sub>IN</sub>			

**Electrical Characteristics—MAX607\_\_ANT25 (V<sub>OUT</sub> = 2.5V)**(V<sub>IN</sub> = +5.0V, I<sub>OUT</sub> = 0mA, C<sub>IN</sub> = C<sub>OUT</sub> = 0.1μF, T<sub>A</sub> = 0°C to +85°C, unless otherwise noted. Typical values are at T<sub>A</sub> = +25°C.) (Note 1)

PARAMETER	SYMBOL	CONDITIONS	MIN	TYP	MAX	UNITS
<b>OUTPUT</b>						
Output Voltage Accuracy		T <sub>A</sub> = +25°C	-0.1		+0.1	%
Output Voltage Temperature Drift (Note 2)	TCV <sub>OUT</sub>			2.7	10	ppm/°C
Line Regulation		Over specified V <sub>IN</sub> range		60	300	μV/V
		T <sub>A</sub> = T <sub>MIN</sub> to T <sub>MAX</sub>			350	
Load Regulation		0mA < I <sub>OUT</sub> < 10mA, sink		80	200	μV/mA
		0mA < I <sub>OUT</sub> < 10mA, source		75	180	
Dropout Voltage		I <sub>OUT</sub> = 10mA, T <sub>A</sub> = T <sub>MIN</sub> to T <sub>MAX</sub> (Note 3)		110	230	mV
Output Current	I <sub>OUT</sub>		-10		+10	mA
Short-Circuit Current	I <sub>SC</sub>	Sourcing to ground		25		mA
		Sinking from V <sub>IN</sub>		25		
Long-Term Stability		1000 hours at T <sub>A</sub> = +25°C		16		ppm
Thermal Hysteresis		(Note 4)		85		ppm
<b>DYNAMIC CHARACTERISTICS</b>						
Noise Voltage	e <sub>OUT</sub>	1/f noise, 0.1Hz to 10Hz, C <sub>OUT</sub> = 0.1μF		4.8		μV <sub>P-P</sub>
		10Hz to 10kHz, C <sub>OUT</sub> = 0.1μF		6		μV <sub>RMS</sub>
Noise Spectral Density		f <sub>SW</sub> = 1kHz, C <sub>OUT</sub> = 0.1μF		60		nV/√Hz
Ripple Rejection		Frequency = 60Hz		84		dB
Turn-On Settling Time	t <sub>R</sub>	Settling to 0.01%, C <sub>OUT</sub> = 0.1μF		30		μs
Enable Settling Time	t <sub>EN</sub>	Settling to 0.01%, C <sub>OUT</sub> = 0.1μF		75		μs
Capacitive-Load Stability Range		I <sub>OUT</sub> ≤ 10mA	0.1		10	μF
<b>INPUT</b>						
Supply Voltage	V <sub>IN</sub>	Guaranteed by line regulation	2.8		5	V
Quiescent Supply Current	I <sub>IN</sub>	T <sub>A</sub> = +25°C		160	250	μA
		T <sub>A</sub> = T <sub>MIN</sub> to T <sub>MAX</sub>			320	
Shutdown Supply Current	I <sub>SD</sub>			0.6	6	μA
<b>ENABLE/SHUTDOWN</b>						
Enable Input Current	I <sub>EN</sub>		-1		+1	μA
Enable Logic-High	V <sub>IH</sub>		0.7 × V <sub>IN</sub>			V
Enable Logic-Low	V <sub>IL</sub>		0.3 × V <sub>IN</sub>			

**Electrical Characteristics—MAX607\_\_AUT30 (V<sub>OUT</sub> = 3.000V)**(V<sub>IN</sub> = +5.0V, I<sub>OUT</sub> = 0mA, C<sub>OUT</sub> = 0.1μF, T<sub>A</sub> = -40°C to +125°C, unless otherwise noted. Typical values are at T<sub>A</sub> = +25°C.) (Note 1)

PARAMETER	SYMBOL	CONDITIONS	MIN	TYP	MAX	UNITS
<b>OUTPUT</b>						
Output Voltage Accuracy		MAX6070A/MAX6071A, T <sub>A</sub> = +25°C	-0.04		+0.04	%
		MAX6070B/MAX6071B, T <sub>A</sub> = +25°C	-0.08		+0.08	
Output Voltage Temperature Drift (Note 2)	TCV <sub>OUT</sub>	MAX6070A/MAX6071A		1.5	6	ppm/°C
		MAX6070B/MAX6071B		2.0	8	
Line Regulation		Over specified V <sub>IN</sub> range	T <sub>A</sub> = +25°C	90	200	μV/V
			T <sub>A</sub> = T <sub>MIN</sub> to T <sub>MAX</sub>			
Load Regulation		0mA < I <sub>OUT</sub> < 10mA, sink		90	170	μV/mA
		0mA < I <sub>OUT</sub> < 10mA, source		90	150	
Dropout Voltage		I <sub>OUT</sub> = 10mA, T <sub>A</sub> = T <sub>MIN</sub> to T <sub>MAX</sub> (Note 3)		80	150	mV
Output Current	I <sub>OUT</sub>		-10		+10	mA
Short-Circuit Current	I <sub>SC</sub>	Sourcing to ground		25		mA
		Sinking from V <sub>IN</sub>		25		
Long-Term Stability		1000 hours at T <sub>A</sub> = +25°C		40		ppm
Thermal Hysteresis		(Note 4)		85		ppm
<b>DYNAMIC CHARACTERISTICS</b>						
Noise Voltage	e <sub>OUT</sub>	1/f noise, 0.1Hz to 10Hz, C <sub>OUT</sub> = 0.1μF		4.6		μV <sub>P-P</sub>
		MAX6071 thermal noise, 10Hz to 10kHz, C <sub>OUT</sub> = 0.1μF		7.8		μV <sub>RMS</sub>
		MAX6070 thermal noise, 10Hz to 10kHz, C <sub>OUT</sub> = 0.1μF, C <sub>FILTER</sub> = 0.1μF		5.0		
Ripple Rejection		Frequency = 60Hz		80		dB
Turn-On Settling Time	t <sub>R</sub>	Settling to 0.01%, C <sub>OUT</sub> = 0.1μF	MAX6070, C <sub>FILTER</sub> = 0.1μF	9.7		ms
			MAX6071	40		μs
Enable Settling Time	t <sub>EN</sub>	Settling to 0.01%, C <sub>OUT</sub> = 0.1μF	MAX6070, C <sub>FILTER</sub> = 0.1μF	9.7		ms
			MAX6071	75		μs
Capacitive-Load Stability Range		I <sub>OUT</sub> ≤ 10mA	0.1		10	μF
<b>INPUT</b>						
Supply Voltage	V <sub>IN</sub>	Guaranteed by line regulation	3.2		5.5	V
Quiescent Supply Current	I <sub>IN</sub>	T <sub>A</sub> = +25°C		150	235	μA
		T <sub>A</sub> = T <sub>MIN</sub> to T <sub>MAX</sub>			300	
Shutdown Supply Current	I <sub>SD</sub>			0.6	6	μA
<b>ENABLE/SHUTDOWN</b>						
Enable Input Current	I <sub>EN</sub>		-1		+1	μA
Enable Logic-High	V <sub>IH</sub>		0.7 × V <sub>IN</sub>			V
Enable Logic-Low	V <sub>IL</sub>				0.3 × V <sub>IN</sub>	



**Electrical Characteristics—MAX607\_\_AUT33 (V<sub>OUT</sub> = 3.300V)**(V<sub>IN</sub> = +5.0V, I<sub>OUT</sub> = 0mA, C<sub>OUT</sub> = 0.1μF, T<sub>A</sub> = -40°C to +125°C, unless otherwise noted. Typical values are at T<sub>A</sub> = +25°C.) (Note 1)

PARAMETER	SYMBOL	CONDITIONS	MIN	TYP	MAX	UNITS
<b>OUTPUT</b>						
Output Voltage Accuracy		MAX6070A/MAX6071A, T <sub>A</sub> = +25°C	-0.04		+0.04	%
		MAX6070B/MAX6071B, T <sub>A</sub> = +25°C	-0.08		+0.08	
Output Voltage Temperature Drift (Note 2)	TCV <sub>OUT</sub>	MAX6070A/MAX6071A		1.5	6	ppm/°C
		MAX6070B/MAX6071B		2.0	8	
Line Regulation		Over specified V <sub>IN</sub> range	T <sub>A</sub> = +25°C	90	220	μV/V
			T <sub>A</sub> = T <sub>MIN</sub> to T <sub>MAX</sub>		285	
Load Regulation		0mA < I <sub>OUT</sub> < 10mA, sink		100	190	μV/mA
		0mA < I <sub>OUT</sub> < 10mA, source		100	165	
Dropout Voltage		I <sub>OUT</sub> = 10mA, T <sub>A</sub> = T <sub>MIN</sub> to T <sub>MAX</sub> (Note 3)		65	150	mV
Output Current	I <sub>OUT</sub>		-10		10	mA
Short-Circuit Current	I <sub>SC</sub>	Sourcing to ground		25		mA
		Sinking from V <sub>IN</sub>		25		
Long-Term Stability		1000 hours at T <sub>A</sub> = +25°C		40		ppm
Thermal Hysteresis		(Note 4)		85		ppm
<b>DYNAMIC CHARACTERISTICS</b>						
Noise Voltage	e <sub>OUT</sub>	1/f noise, 0.1Hz to 10Hz, C <sub>OUT</sub> = 0.1μF		10		μV <sub>P-P</sub>
		MAX6071 thermal noise, 10Hz to 10kHz, C <sub>OUT</sub> = 0.1μF		9		μV <sub>RMS</sub>
		MAX6070 thermal noise, 10Hz to 10kHz, C <sub>OUT</sub> = 0.1μF, C <sub>FILTER</sub> = 0.1μF		6		
Ripple Rejection		Frequency = 60Hz		78		dB
Turn-On Settling Time	t <sub>R</sub>	Settling to 0.01%, C <sub>OUT</sub> = 0.1μF	MAX6070, C <sub>FILTER</sub> = 0.1μF	10		ms
			MAX6071		42	
Enable Settling Time	t <sub>EN</sub>	Settling to 0.01%, C <sub>OUT</sub> = 0.1μF	MAX6070, C <sub>FILTER</sub> = 0.1μF	10		ms
			MAX6071		75	
Capacitive-Load Stability Range		I <sub>OUT</sub> ≤ 10mA	0.1		10	μF
<b>INPUT</b>						
Supply Voltage	V <sub>IN</sub>	Guaranteed by line regulation	3.5		5.5	V
Quiescent Supply Current	I <sub>IN</sub>	T <sub>A</sub> = +25°C		160	240	μA
		T <sub>A</sub> = T <sub>MIN</sub> to T <sub>MAX</sub>			330	
Shutdown Supply Current	I <sub>SD</sub>			0.6	6	μA
<b>ENABLE/SHUTDOWN</b>						
Enable Input Current	I <sub>EN</sub>		-1		+1	μA
Enable Logic-High	V <sub>IH</sub>		0.7 × V <sub>IN</sub>			V
Enable Logic-Low	V <sub>IL</sub>				0.3 × V <sub>IN</sub>	

**Electrical Characteristics—MAX607\_\_AUT41 (V<sub>OUT</sub> = 4.096V)**(V<sub>IN</sub> = +5.0V, I<sub>OUT</sub> = 0mA, C<sub>OUT</sub> = 0.1μF, T<sub>A</sub> = -40°C to +125°C, unless otherwise noted. Typical values are at T<sub>A</sub> = +25°C.) (Note 1)

PARAMETER	SYMBOL	CONDITIONS	MIN	TYP	MAX	UNITS
<b>OUTPUT</b>						
Output Voltage Accuracy		MAX6070A/MAX6071A, T <sub>A</sub> = +25°C	-0.04		+0.04	%
		MAX6070B/MAX6071B, T <sub>A</sub> = +25°C	-0.08		+0.08	
		MAX6070D, T <sub>A</sub> = +25°C	-0.2		+0.2	
Output Voltage Temperature Drift (Note 2)	TCV <sub>OUT</sub>	MAX6070A/MAX6071A		1.5	6	ppm/ °C
		MAX6070B/MAX6071B		2.0	8	
Line Regulation		Over specified V <sub>IN</sub> range	T <sub>A</sub> = +25°C	100	250	μV/V
			T <sub>A</sub> = T <sub>MIN</sub> to T <sub>MAX</sub>		350	
Load Regulation		0mA < I <sub>OUT</sub> < 10mA, sink		125	225	μV/mA
		0mA < I <sub>OUT</sub> < 10mA, source		135	225	
Dropout Voltage		I <sub>OUT</sub> = 10mA, T <sub>A</sub> = T <sub>MIN</sub> to T <sub>MAX</sub> (Note 3)		75	150	mV
Output Current	I <sub>OUT</sub>		-10		+10	mA
Short-Circuit Current	I <sub>SC</sub>	Sourcing to ground		25		mA
		Sinking from V <sub>IN</sub>		25		
Long-Term Stability		1000 hours at T <sub>A</sub> = +25°C		35		ppm
Thermal Hysteresis		(Note 4)		85		ppm
<b>DYNAMIC CHARACTERISTICS</b>						
Noise Voltage	e <sub>OUT</sub>	1/f noise, 0.1Hz to 10Hz, C <sub>OUT</sub> = 0.1μF		9.6		μV <sub>P-P</sub>
		MAX6071 thermal noise, 10Hz to 10kHz, C <sub>OUT</sub> = 0.1μF		12		μV <sub>RMS</sub>
		MAX6070 thermal noise, 10Hz to 10kHz, C <sub>OUT</sub> = 0.1μF, C <sub>FILTER</sub> = 0.1μF		9		
Ripple Rejection		Frequency = 60Hz		80		dB
Turn-On Settling Time	t <sub>R</sub>	Settling to 0.01%, C <sub>OUT</sub> = 0.1μF	MAX6070, C <sub>FILTER</sub> = 0.1μF	10		ms
			MAX6071	40		μs
Enable Settling Time	t <sub>EN</sub>	Settling to 0.01%, C <sub>OUT</sub> = 0.1μF	MAX6070, C <sub>FILTER</sub> = 0.1μF	10		ms
			MAX6071	85		μs
Capacitive-Load Stability Range		I <sub>OUT</sub> ≤ 10mA	0.1		10	μF
<b>INPUT</b>						
Supply Voltage	V <sub>IN</sub>	Guaranteed by line regulation	4.3		5.5	V
Quiescent Supply Current	I <sub>IN</sub>	T <sub>A</sub> = +25°C		150	235	μA
		T <sub>A</sub> = T <sub>MIN</sub> to T <sub>MAX</sub>			350	
Shutdown Supply Current	I <sub>SD</sub>				6	μA
<b>ENABLE</b>						
Enable Input Current	I <sub>EN</sub>		-1		+1	μA
Enable Logic-High	V <sub>IH</sub>		0.7 × V <sub>IN</sub>			V
Enable Logic-Low	V <sub>IL</sub>				0.3 × V <sub>IN</sub>	

**Electrical Characteristics—MAX607\_\_AUT50 (V<sub>OUT</sub> = 5.000V)**(V<sub>IN</sub> = +5.5V, I<sub>OUT</sub> = 0mA, C<sub>OUT</sub> = 0.1μF, T<sub>A</sub> = -40°C to +125°C, unless otherwise noted. Typical values are at T<sub>A</sub> = +25°C.) (Note 1)

PARAMETER	SYMBOL	CONDITIONS		MIN	TYP	MAX	UNITS
<b>OUTPUT</b>							
Output Voltage Accuracy		MAX6070A/MAX6071A, T <sub>A</sub> = +25°C		-0.04		+0.04	%
		MAX6070B/MAX6071B, T <sub>A</sub> = +25°C		-0.08		+0.08	
Output Voltage Temperature Drift (Note 2)	TCV <sub>OUT</sub>	MAX6070A/MAX6071A			1.5	6	ppm/°C
		MAX6070B/MAX6071B			2.0	8	
Line Regulation		Over specified V <sub>IN</sub> range	T <sub>A</sub> = +25°C		200	400	μV/V
			T <sub>A</sub> = T <sub>MIN</sub> to T <sub>MAX</sub>			500	
Load Regulation		0mA < I <sub>OUT</sub> < 10mA, sink			160	275	μV/mA
		0mA < I <sub>OUT</sub> < 10mA, source			160	275	
Dropout Voltage		I <sub>OUT</sub> = 10mA, T <sub>A</sub> = T <sub>MIN</sub> to T <sub>MAX</sub> (Note 5)			60	150	mV
Output Current	I <sub>OUT</sub>			-10		+10	mA
Short-Circuit Current	I <sub>SC</sub>	Sourcing to ground			25		mA
		Sinking from V <sub>IN</sub>			25		
Long-Term Stability		1000 hours at T <sub>A</sub> = +25°C			35		ppm
Thermal Hysteresis		(Note 4)			85		ppm
<b>DYNAMIC CHARACTERISTICS</b>							
Noise Voltage	e <sub>OUT</sub>	1/f noise, 0.1Hz to 10Hz, C <sub>OUT</sub> = 0.1μF			9		μV <sub>P-P</sub>
		MAX6071 thermal noise, 10Hz to 10kHz, C <sub>OUT</sub> = 0.1μF			15		μV <sub>RMS</sub>
		MAX6070 thermal noise, 10Hz to 10kHz, C <sub>OUT</sub> = 0.1μF, C <sub>FILTER</sub> = 0.1μF			12		
Ripple Rejection		Frequency = 60Hz			74		dB
Turn-On Settling Time	t <sub>R</sub>	Settling to 0.01%, C <sub>OUT</sub> = 0.1μF	MAX6070, C <sub>FILTER</sub> = 0.1μF		10		ms
			MAX6071		50		μs
Enable Settling Time	t <sub>EN</sub>	Settling to 0.01%, C <sub>OUT</sub> = 0.1μF	MAX6070, C <sub>FILTER</sub> = 0.1μF		10		ms
			MAX6071		100		μs
Capacitive-Load Stability Range		I <sub>OUT</sub> ≤ 10mA		0.1		10	μF
<b>INPUT</b>							
Supply Voltage	V <sub>IN</sub>	Guaranteed by line regulation		5.2		5.5	V
Quiescent Supply Current	I <sub>IN</sub>	T <sub>A</sub> = +25°C			160	250	μA
		T <sub>A</sub> = T <sub>MIN</sub> to T <sub>MAX</sub>				330	
Shutdown Supply Current	I <sub>SD</sub>					6	μA
<b>ENABLE</b>							
Enable Input Current	I <sub>EN</sub>			-1		+1	μA
Enable Logic-High	V <sub>IH</sub>			0.7 × V <sub>IN</sub>			V
Enable Logic-Low	V <sub>IL</sub>					0.3 × V <sub>IN</sub>	

**Electrical Characteristics—MAX607\_\_AUT50 ( $V_{OUT} = 5.000V$ ) (continued)**

( $V_{IN} = +5.5V$ ,  $I_{OUT} = 0mA$ ,  $C_{OUT} = 0.1\mu F$ ,  $T_A = -40^{\circ}C$  to  $+125^{\circ}C$ , unless otherwise noted. Typical values are at  $T_A = +25^{\circ}C$ .) (Note 1)

- Note 1:** Limits are 100% production tested at  $T_A = +25^{\circ}C$ . Specifications where  $T_A < +25^{\circ}C$  or  $T_A > +25^{\circ}C$  are guaranteed by design and characterization.
- Note 2:** Temperature coefficient is calculated using the "box method" which measures temperature drift as the maximum voltage variation over a specified temperature range. The unit of measurement is ppm/ $^{\circ}C$ .
- Note 3:** Dropout voltage is defined as the minimum differential voltage ( $V_{IN} - V_{OUT}$ ) at which  $V_{OUT}$  decreases by 0.2% from its original value at  $V_{IN} = 5.0V$ .
- Note 4:** Thermal hysteresis is defined as the change in  $+25^{\circ}C$  output voltage before and after cycling the device from  $T_{MAX}$  to  $T_{MIN}$ .
- Note 5:** Dropout voltage is defined as the minimum differential voltage ( $V_{IN} - V_{OUT}$ ) at which  $V_{OUT}$  decreases by 0.2% from its original value at  $V_{IN} = 5.5V$ .

Typical Operating Characteristics

( $T_A = +25^\circ\text{C}$ , unless otherwise noted.)

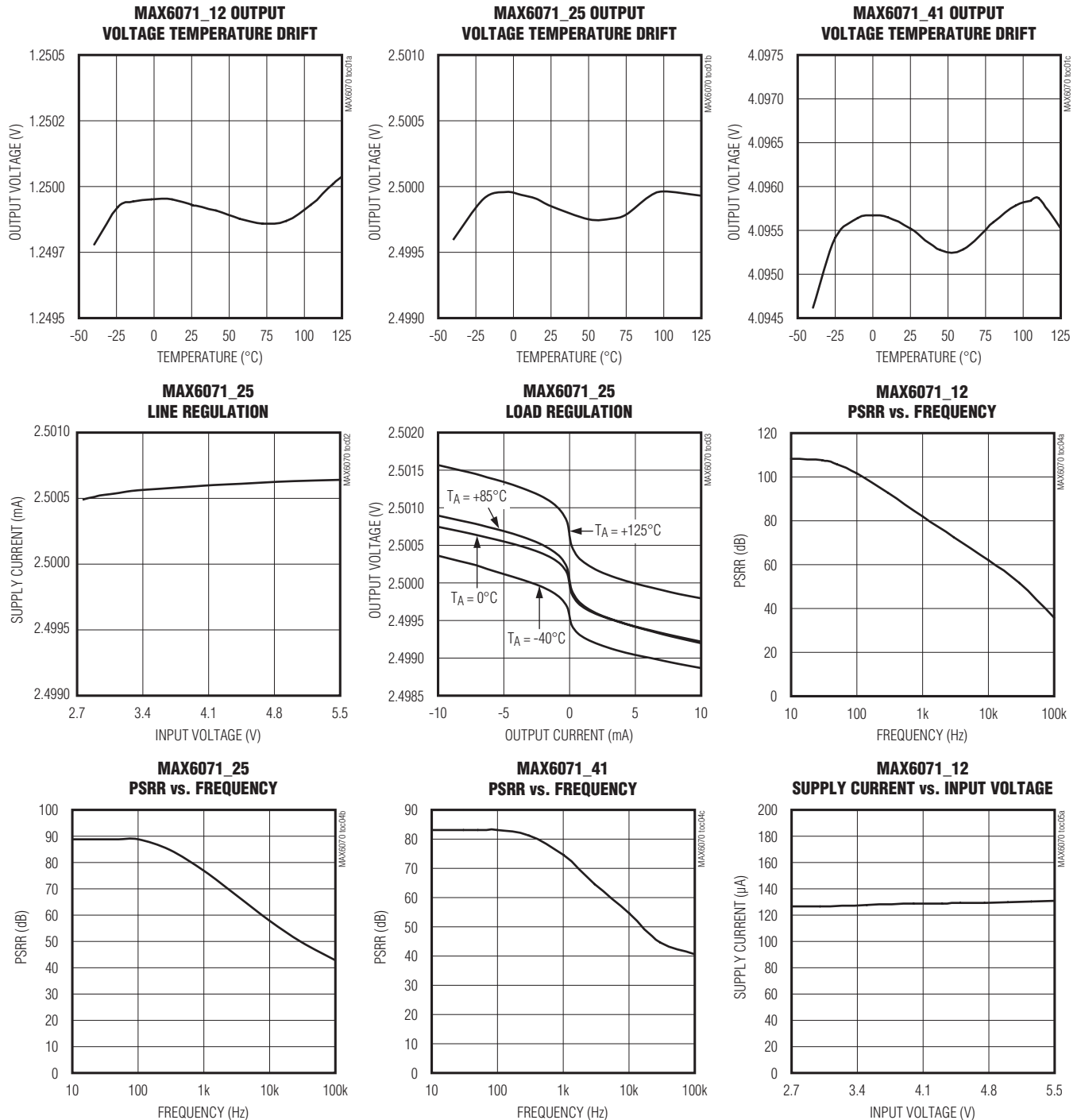

Typical Operating Characteristics (continued)

( $T_A = +25^\circ\text{C}$ , unless otherwise noted.)

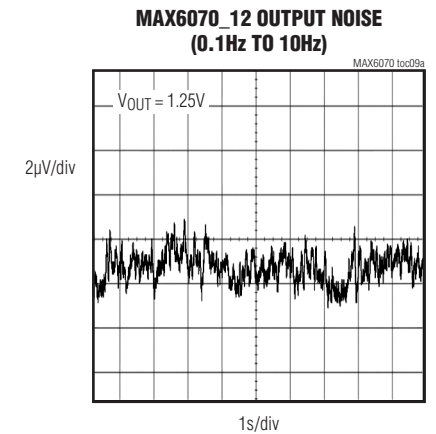
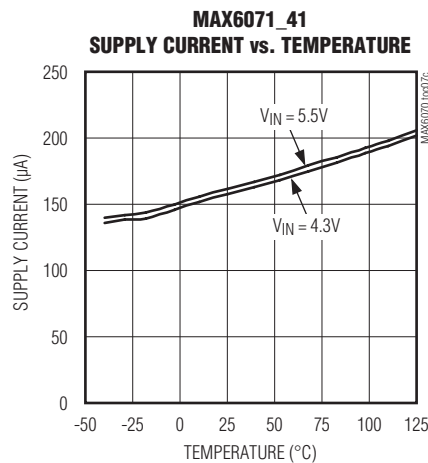
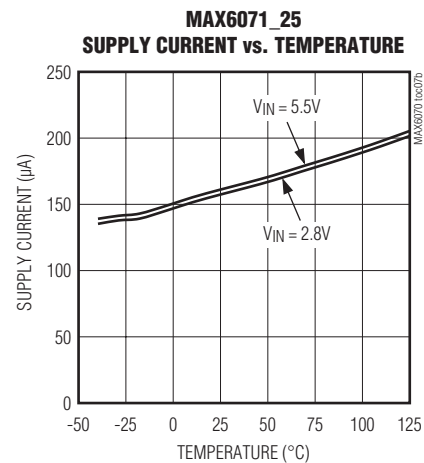
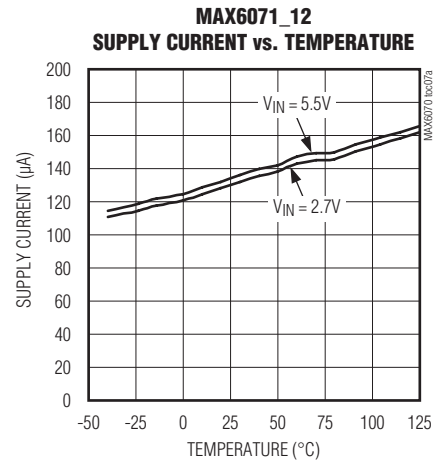
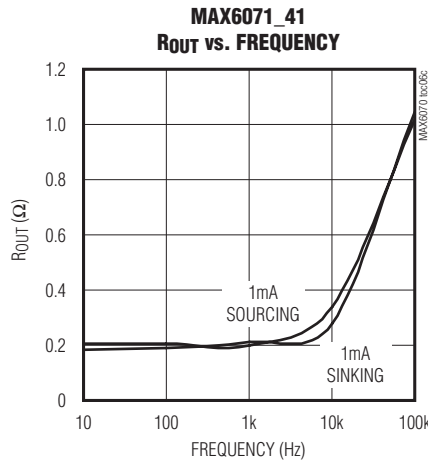
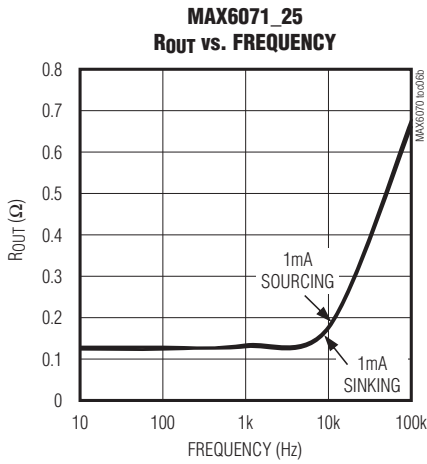
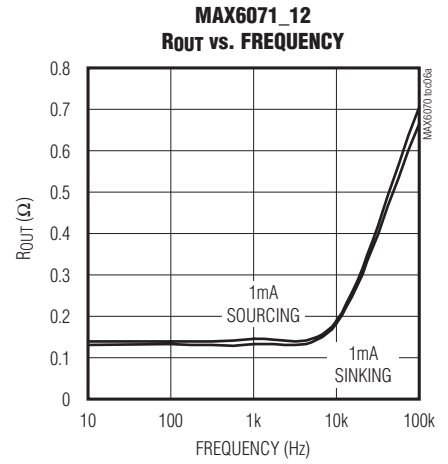
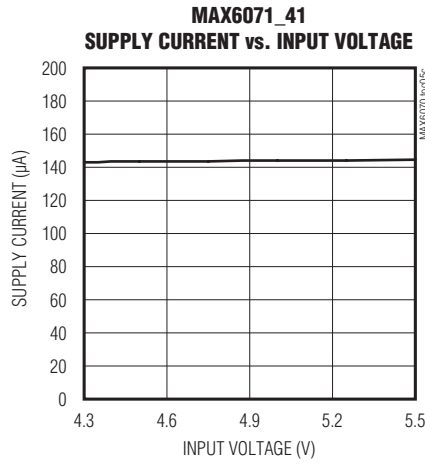
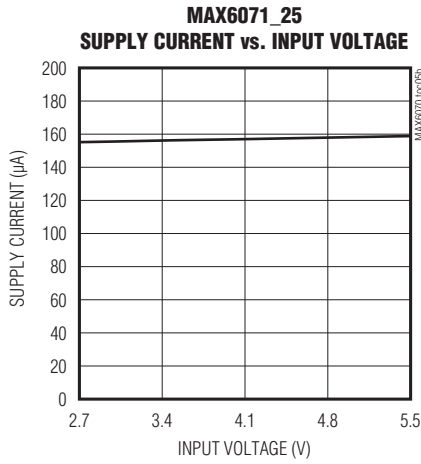

Typical Operating Characteristics (continued)

( $T_A = +25^\circ\text{C}$ , unless otherwise noted.)

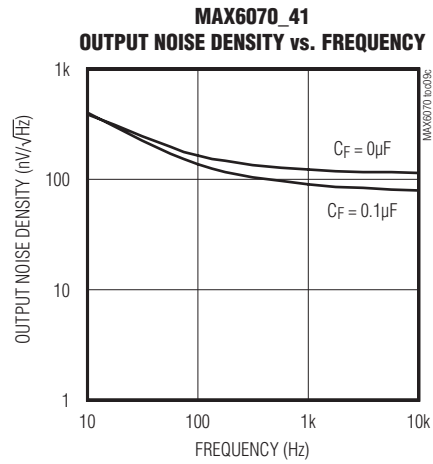
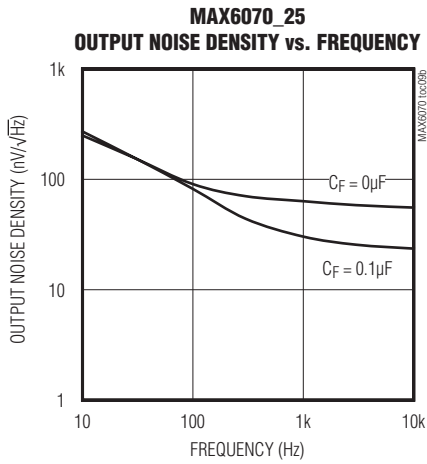
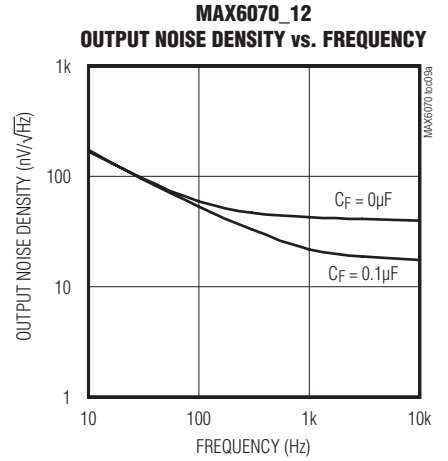
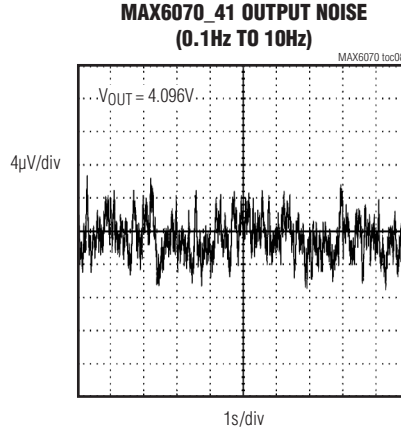
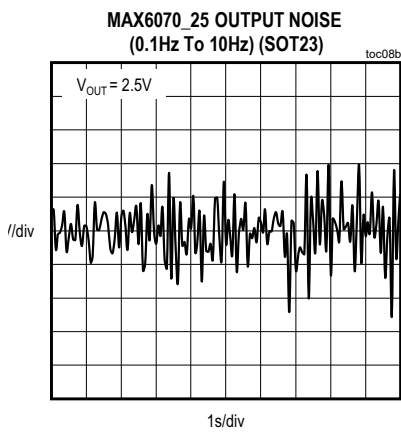

Typical Operating Characteristics (continued)

( $T_A = +25^\circ\text{C}$ , unless otherwise noted.)

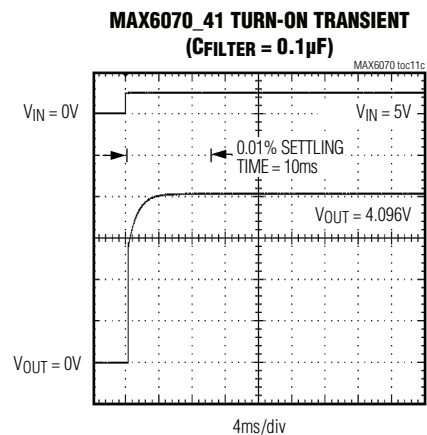
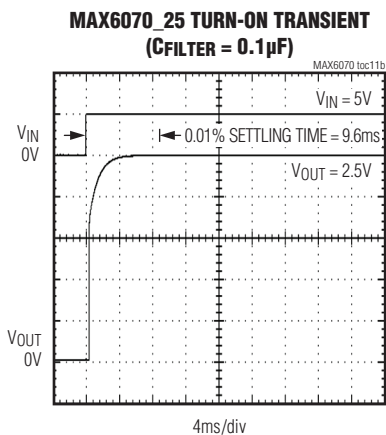
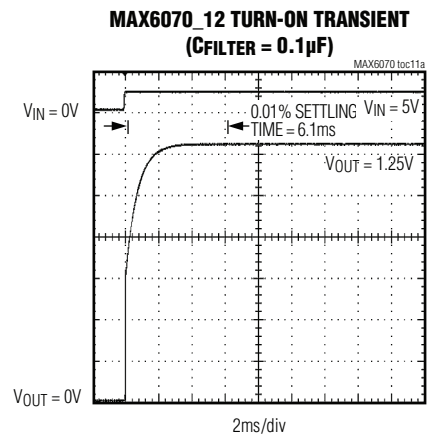
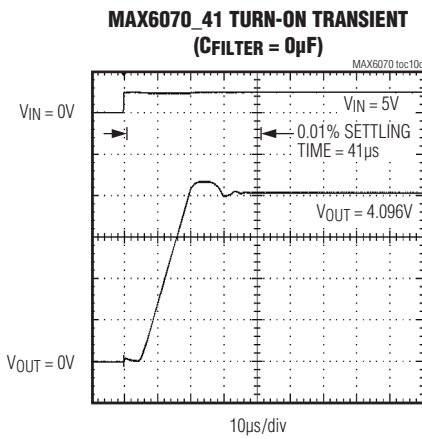
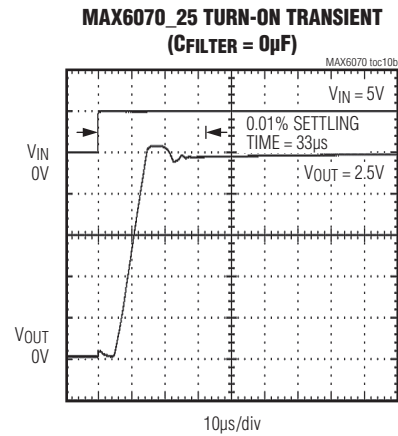
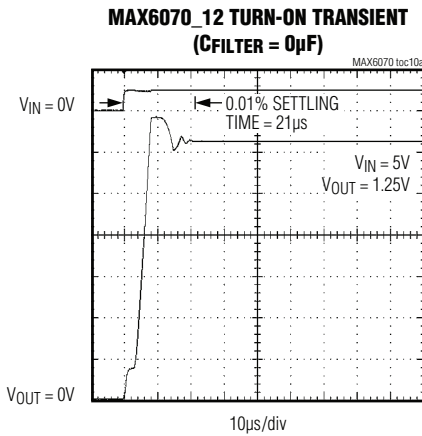



Typical Operating Characteristics (continued)

( $T_A = +25^\circ\text{C}$ , unless otherwise noted.)

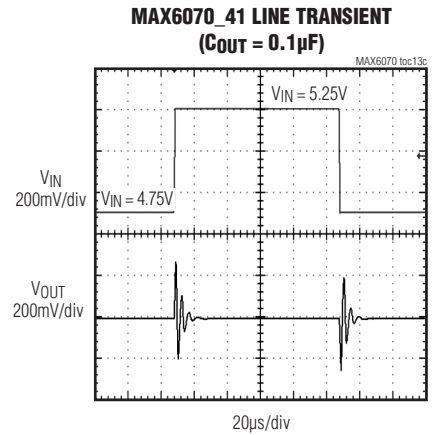
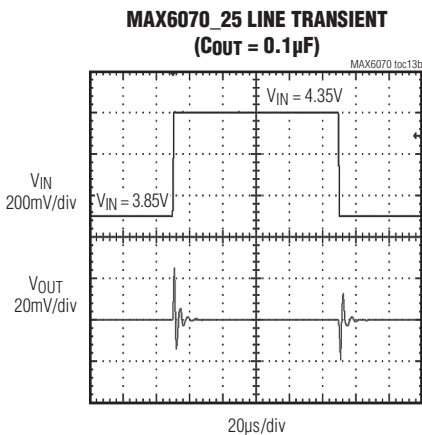
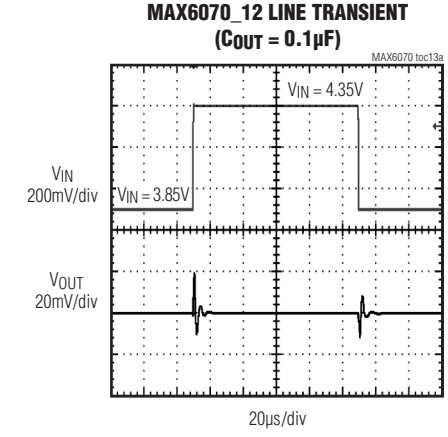
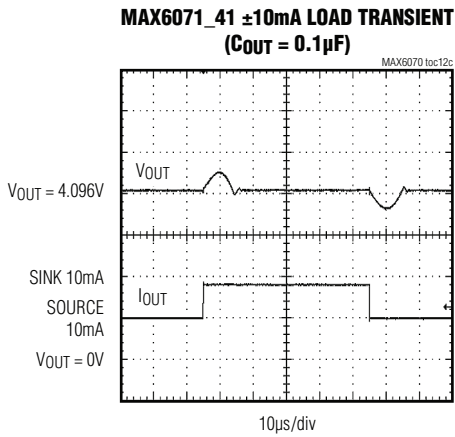
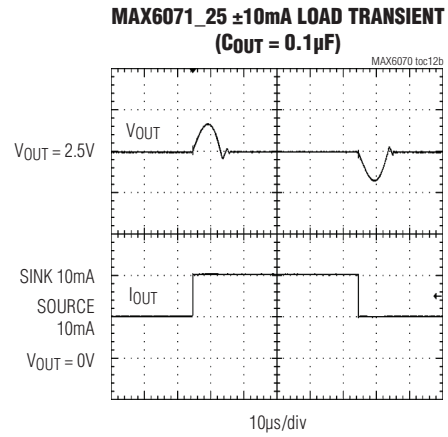
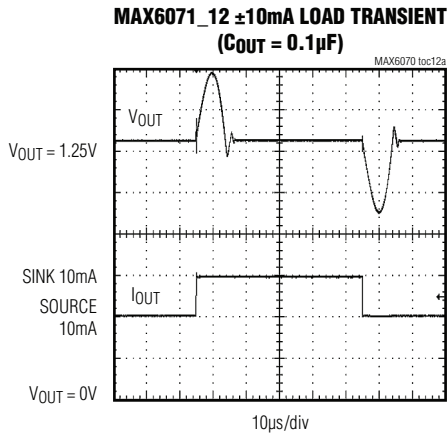

Typical Operating Characteristics (continued)

( $T_A = +25^\circ\text{C}$ , unless otherwise noted.)

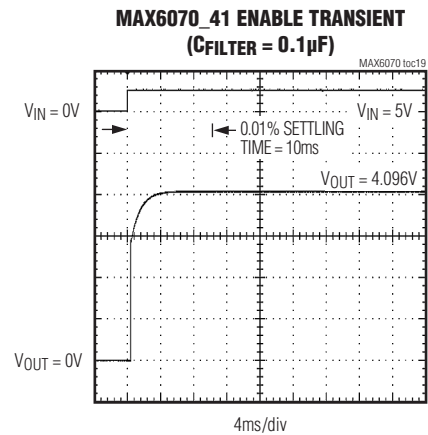
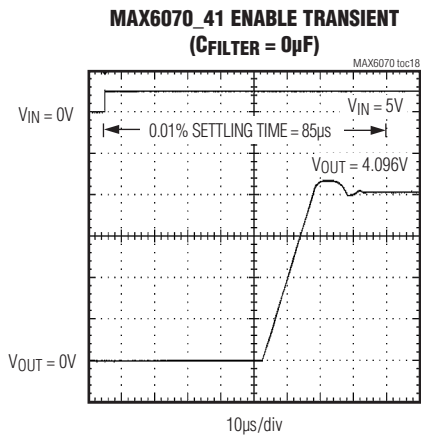
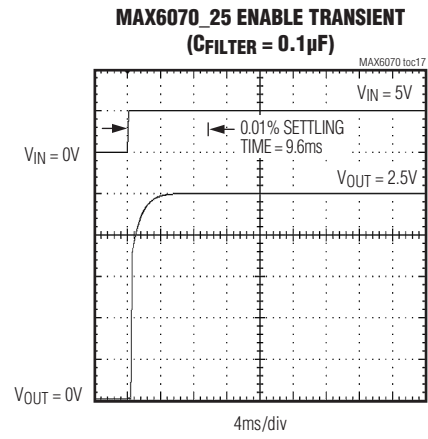
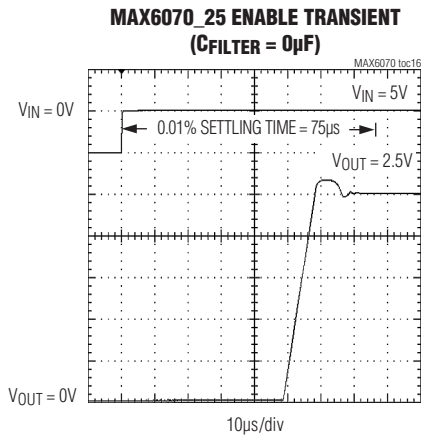
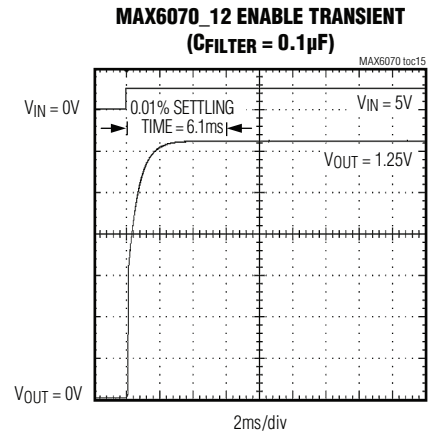
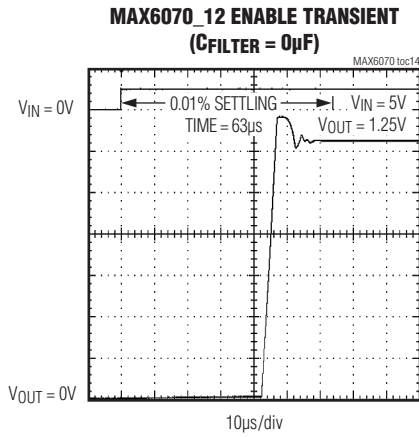

## Pin Configurations

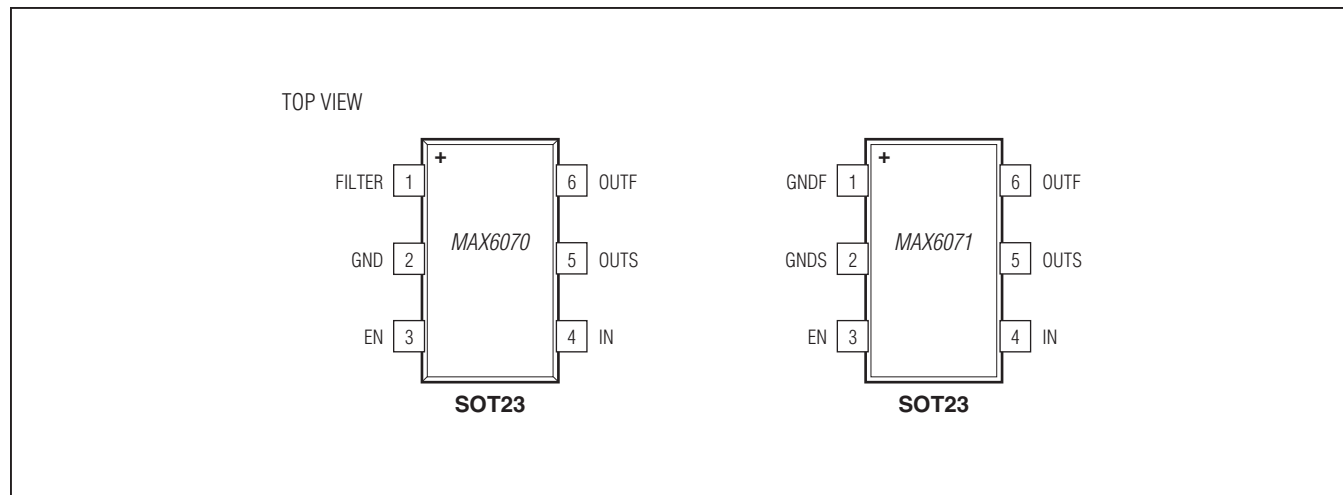

## Pin Description

PIN		NAME	FUNCTION
MAX6070	MAX6071		
1	—	FILTER	Filter Input. Connect a 0.1 $\mu$ F capacitor from FILTER to ground to provide high-frequency bypass. Leave unconnected, if not used.
—	1	GNDF	Ground Force
2	—	GND	Ground
-	2	GNDS	Ground Sense. Connect to ground connection at the load.
3	3	EN	Enable. Drive high to enable the device. Drive low to disable the device.
4	4	IN	Supply Input
5	5	OUTS	Voltage Reference Sense Output
6	6	OUTF	Voltage Reference Force Output. Short OUTF to OUTS as close as possible to the load. Bypass OUTF with a capacitor (0.1 $\mu$ F to 10 $\mu$ F) to GND.

**Bump Configuration**

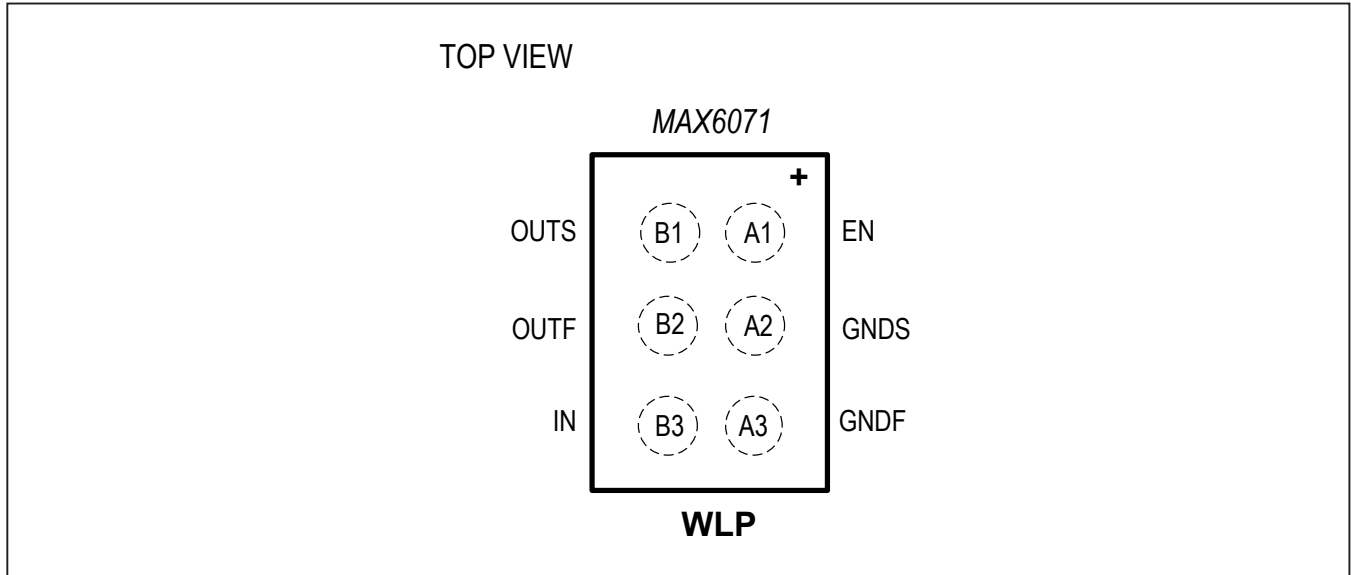

**Bump Description**

BUMP	NAME	FUNCTION
A1	EN	Enable. Drive high to enable the device. Drive low to disable the device.
A2	GNDS	Ground Sense. Connect to ground connection at the load.
A3	GNDF	Ground Force
B1	OUTS	Voltage Reference Sense Output
B2	OUTF	Voltage Reference Force Output. Short OUTF to OUTS as close as possible to the load. Bypass OUTF with a capacitor (0.1µF to 10µF) to GNDF.
B3	IN	Supply Input. Connect a 0.1µF capacitor to GNDF.

## Detailed Description

### Wideband Noise Reduction (FILTER)

To improve wideband noise and transient power-supply noise with the MAX6070, connect a 0.1µF capacitor from FILTER to GND (see the [Typical Operating Characteristics](#)). Larger values do not appreciably improve noise reduction. A 0.1µF capacitor reduces the spectral noise density at 1kHz from 60nV/√Hz to 30nV/√Hz for the 2.5V output. Noise at the input pin can affect output noise, but can be reduced by connecting an optional bypass capacitor between IN and GND as shown in [Figure 1](#).

### Output Bypassing

The MAX6070/MAX6071 require an output capacitor between 0.1µF and 10µF. Place the output capacitor as close to OUTF as possible. For applications driving switching capacitive loads or rapidly changing load currents, use a 0.1µF capacitor in parallel with a larger load capacitor to reduce equivalent series resistance (ESR). Larger capacitor values and lower ESR reduce transients on the reference output.

### Supply Current

The MAX6070/MAX6071 draw 150µA of current and are virtually independent of the supply voltage, with only a 1.6µA/V variation with supply voltage.

### Thermal Hysteresis

Thermal hysteresis is the change of output voltage at  $T_A = +25^\circ\text{C}$  before and after the device is cycled over its entire operating temperature range. The typical thermal hysteresis value is 85ppm.

### Turn-On Time

These devices typically turn on and settle to within 0.01% of their final value in 30µs. A noise reduction capacitor of 0.1µF increases the turn-on time of the MAX6070 to 10ms.

### Output Force and Sense

The MAX6070/MAX6071 provide independent connections for the force output (OUTF) supplying current to the load and the circuit input regulating the load voltage via the output sense pin (OUTS). This configuration allows for the cancellation of the voltage drop on the lines connecting the MAX6070/MAX6071 and the load. When using the Kelvin connection made possible by the independent force and sense outputs, connect OUTF to the load and

connect OUTS to OUTF at the point where the voltage accuracy is needed (see [Figure 1](#)). The MAX6071 features the same type of Kelvin connection to cancel drops in the ground return line. Connect the load to ground and connect GNDS to ground as close as possible to the load ground connection (see [Figure 2](#)).

### Shutdown

The MAX6070/MAX6071 feature an active-high enable pin (EN). Pulling EN low disables the output with a resistive load to ground and forces the quiescent current to less than 1µA. The value of the load is typically 200kΩ. Pulling EN high enables normal operation.

## Applications Information

### Wideband Noise Reduction

[Figure 1](#) shows a typical noise reduction filter application circuit. Note that the use of the wideband noise filter will increase turn-on time.

### High-Resolution DAC and Reference from a Single Supply

[Figure 2](#) shows a typical circuit providing the reference for a high-resolution, 16-bit MAX541 DAC.

### Precision Current Source

[Figure 3](#) shows a typical circuit providing a precision current source. The OUTF output provides the bias current for the bipolar transistor. OUTS and GNDS sense the voltage across the resistor and adjust the current sourced by OUTF accordingly.

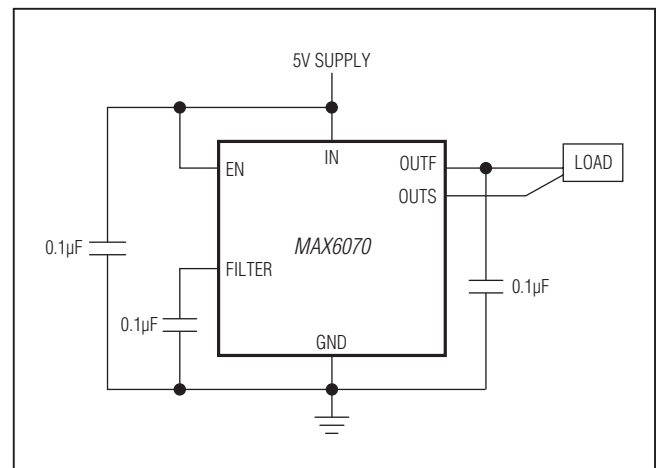

Figure 1. Reference Output Kelvin Connection

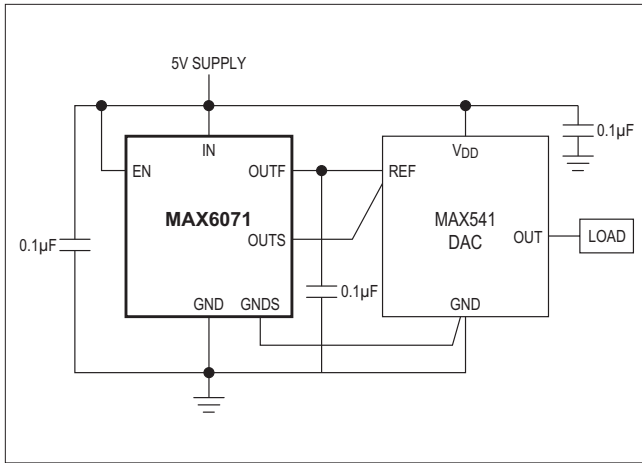

Figure 2. Reference Ground Kelvin Connection

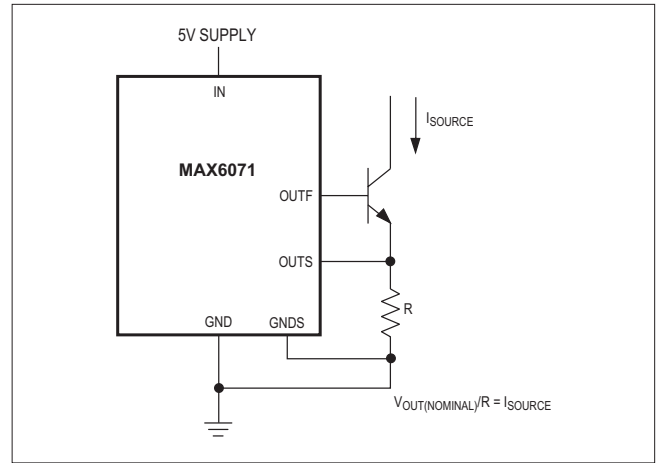

Figure 3. Precision Current Source

**Long-Term Drift and Humidity Effects**

There are many factors that contribute to a voltage reference’s drift over time. These can include package stress, board stress and layout, humidity and part-to-part variation. In an effort to better quantify the drift of the MAX6070 core over time, Maxim has evaluated 16 samples on two identical bench setups. Sixteen MAX6070AAUT25+ samples were installed on a pair of development boards. One board was set up in a humidity and temperature controlled oven. The conditions were set to 25°C and 40% relative humidity. The second board was set up on the lab bench in the open air, where humidity was measured to fluctuate between 18% and 51%.

The results of these experiments are detailed in [Figure 4](#), [Figure 5](#), and [Figure 6](#). The latest data shows the drift out to 5,800 hours. The y axis is the drift, measured in parts per million, between +50ppm and -50ppm. [Figure 4](#) shows the 16 parts on the lab bench in the open air. It is here the effects of the humidity fluctuating between 18% and 51% can be seen.

[Figure 5](#) details the same set up in the humidity controlled oven. Temperature (25°C) and humidity (40%) are relatively consistent inside the oven. Data was affected a bit about the

2,500 hour mark when the pump that regulates the humidity temporarily stopped working for about 48 hours. This caused a brief spike in the output voltages before they returned to their previous profile.

[Figure 6](#) shows the results of temperature and humidity measurements both inside and outside the oven. The key parameter to note is the purple line which represents the humidity outside

the oven (on the lab bench). The swings in humidity are apparent in [Figure 4](#), with the output voltage drift primarily tracking the humidity changes.

Maxim is studying the effects of drift and humidity on multiple references beyond 1,000 hours. Contact the Maxim technical support line or your local sales office for details on the latest data.

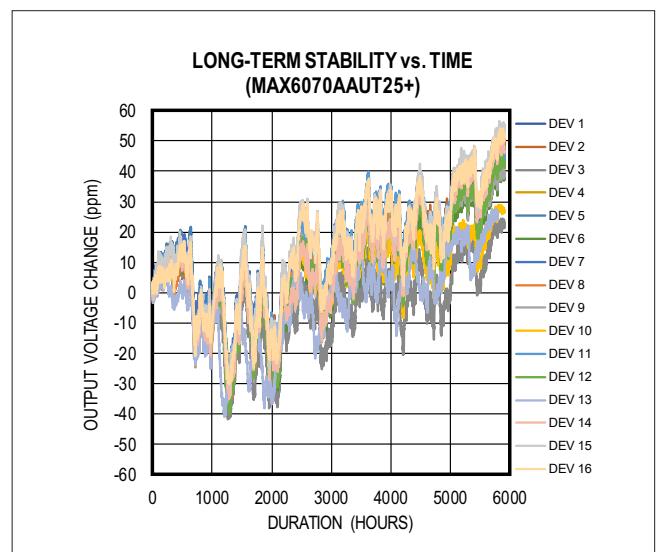

Figure 4. MAX6070AAUT2.5+ Long-Term Drift on the Bench Setup

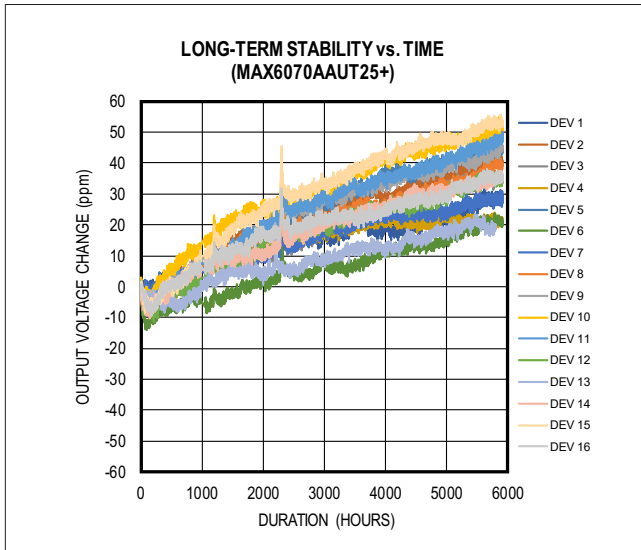

Figure 5. MAX6070AAUT25+ Long-Term Drift in the Oven (Temperature = +25°C, Relative Humidity = 40%)

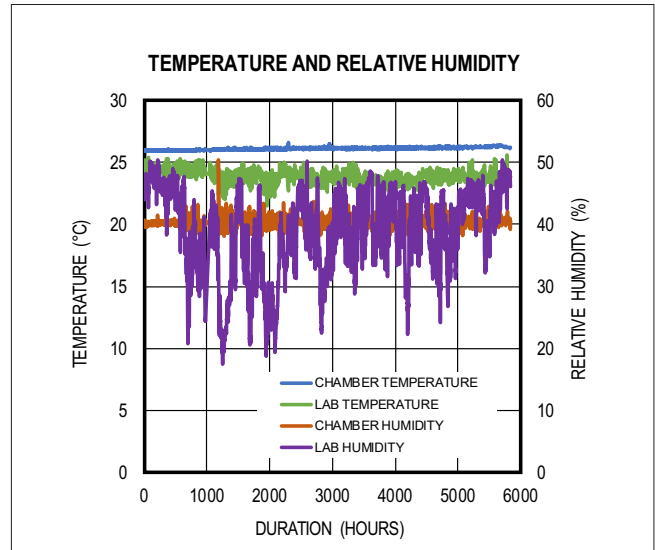

Figure 6. Temperature and Relative Humidity Measured Inside the Oven and in the Lab Benchtop Environment

## Selector Guide

PART	FILTER	V <sub>OUT</sub> (V)	ACCURACY (%)	TOP MARK
MAX6070AAUT12+T	Yes	1.25	0.04	+ACPF
MAX6070AAUT18/V+T	Yes	1.8	0.04	+ACVV
MAX6070AAUT18+T	Yes	1.8	0.04	+ACPH
MAX6070AAUT21+T	Yes	2.048	0.04	+ACPJ
MAX6070AAUT25+T	Yes	2.5	0.04	+ACPL
MAX6070AAUT30+T	Yes	3.0	0.04	+ACPN
MAX6070AAUT33+T	Yes	3.3	0.04	+ACPP
MAX6070AAUT33/V+T	Yes	3.3	0.04	+ACVN
MAX6070AAUT41+T	Yes	4.096	0.04	+ACPR
MAX6070AAUT50+T	Yes	5.0	0.04	+ACPV
MAX6070AAUT50/V+T	Yes	5.0	0.04	+ACTR
MAX6070BAUT12+T	Yes	1.25	0.08	+ACPG
MAX6070BAUT12/V+T	Yes	1.25	0.08	+ACSP
MAX6070BAUT18+T	Yes	1.8	0.08	+ACPI
MAX6070BAUT21+T	Yes	2.048	0.08	+ACPK
MAX6070BAUT21/V+T	Yes	2.048	0.08	+ACVG
MAX6070BAUT25+T	Yes	2.5	0.08	+ACPM
MAX6070BAUT25/V+T	Yes	2.5	0.08	+ACTS
MAX6070BAUT30+T	Yes	3.0	0.08	+ACPO
MAX6071AAUT30/V+T	No	3.0	0.04	+ACVQ
MAX6070BAUT33+T	Yes	3.3	0.08	+ACPQ
MAX6070BAUT33/V+T	Yes	3.3	0.08	+ACUY
MAX6070BAUT41+T	Yes	4.096	0.08	+ACPS
MAX6070BAUT41/V+T	Yes	4.096	0.08	+ACTT
MAX6070DAUT41/V+T*	Yes	4.096	0.2	+ACWC
MAX6070BAUT50+T	Yes	5.0	0.08	+ACPW
MAX6070BAUT50/V+T	Yes	5.0	0.08	+ACVA
MAX6071AAUT12+T	No	1.25	0.04	+ACPX
MAX6071AAUT18+T	No	1.8	0.04	+ACPZ
MAX6071AAUT21+T	No	2.048	0.04	+ACQB
MAX6071AAUT25+T	No	2.5	0.04	+ACQD
MAX6071AAUT30+T	No	3.0	0.04	+ACQF
MAX6071AAUT33+T	No	3.3	0.04	+ACQH
MAX6071AAUT41+T	No	4.096	0.04	+ACQJ
MAX6071AAUT50+T	No	5.0	0.04	+ACQN
MAX6071BAUT12+T	No	1.25	0.08	+ACPY
MAX6071BAUT18+T	No	1.8	0.08	+ACQA
MAX6071BAUT21+T	No	2.048	0.08	+ACQC
MAX6071BAUT25+T	No	2.5	0.08	+ACQE
MAX6071ANT25+T	No	2.5	0.1	+F
MAX6071BAUT25/V+T*	No	2.5	0.08	+ACTU
MAX6071BAUT30+T	No	3.0	0.08	+ACQG
MAX6071BAUT33+T	No	3.3	0.08	+ACQI
MAX6071BAUT41+T	No	4.096	0.08	+ACQK
MAX6071BAUT41/V+T*	No	4.096	0.08	+ACTV
MAX6071BAUT50+T	No	5.0	0.08	+ACQO
MAX6071BAUT50/V+T*	No	5.0	0.08	+ACTW

/V denotes an automotive qualified part.

+Denotes a lead(Pb)-free/RoHS-compliant package.

T = Tape and reel.

\*Future product—contact factory for availability.



## Ordering Information

PART	TEMP RANGE	PIN-PACKAGE
MAX6070AAUT18/V+T	-40°C to +125°C	6 SOT23
MAX6070_AUT__+T	-40°C to +125°C	6 SOT23
MAX6070AAUT33/V+T	-40°C to +125°C	6 SOT23
MAX6070AAUT50/V+T	-40°C to +125°C	6 SOT23
MAX6070BAUT12/V+T	-40°C to +125°C	6 SOT23
MAX6070BAUT21/V+T	-40°C to +125°C	6 SOT23
MAX6070BAUT25/V+T	-40°C to +125°C	6 SOT23
MAX6070BAUT33/V+T	-40°C to +125°C	6 SOT23
MAX6070BAUT41/V+T	-40°C to +125°C	6 SOT23
MAX6070DAUT41/V+T*	-40°C to +125°C	6 SOT23
MAX6071_AUT__+T	-40°C to +125°C	6 SOT23
MAX6071ANT25+T	-40°C to +125°C	6 WLP
MAX6071AAUT30/V+T	-40°C to +125°C	6 SOT23

+Denotes a lead(Pb)-free/RoHS-compliant package.

T = Tape and reel.

Future product—contact factory for availability.

**Note:** The MAX6070/MAX6071 are available in A, B, or D grade with various output voltages. Choose the desired grade and output voltage from the Selector Guide and insert the suffix in the blank above to complete the part number.

## Chip Information

PROCESS: BIPOLAR

## Revision History

REVISION NUMBER	REVISION DATE	DESCRIPTION	PAGES CHANGED
0	10/12	Initial release	—
1	1/13	Added 2.048V, 3.0V, and 5.0V options to data sheet. Revised <i>General Description, Benefits and Features, Absolute Maximum Ratings, Electrical Characteristics, and Selector Guide</i>	1–9, 17, 18
2	3/13	Added 1.8V and 3.3V options to data sheet. Revised <i>General Description, Benefits and Features, Electrical Characteristics, and Selector Guide</i>	1, 2–12, 21, 22
3	2/14	Added automotive package for the MAX6070B.	21
4	7/15	Added automotive packages to data sheet and revised TOC9b. Revised <i>Benefits and Features</i> section.	1, 16, 22, 23
5	1/16	Added WLP option text, associated <i>Electrical Characteristics</i> table, package drawing and <i>Bump Description</i> table	1, 2, 7, 19, 22
6	12/17	Added AEC statement to <i>Benefits and Features</i> section and updated <i>Selector Guide</i>	1, 23
7	3/18	Updated <i>Selector Guide</i> and <i>Ordering Information</i> tables	23, 24
8	8/18	Updated <i>Selector Guide</i> and <i>Ordering Information</i> tables	23, 24
9	9/18	Updated <i>Selector Guide</i> and <i>Ordering Information</i> tables	23, 24
10	10/18	Updated <i>Applications Information, Packaging Information, Electrical Characteristics</i> table, <i>Selector Guide</i> , and <i>Ordering Information</i>	1, 2–12, 23, 24
11	12/18	Updated <i>Selector Guide</i> and <i>Ordering Information</i>	23, 24
12	3/19	Updated <i>Package Information, Detailed Description, Selector Guide</i> , and <i>Ordering Information</i>	2, 22–24
13	5/19	Updated <i>Package Information</i>	2
14	7/19	Updated <i>Ordering Information and Selector Guide</i>	24, 25
15	11/19	Updated <i>Electrical Characteristics, Selector Guide</i> , and <i>Ordering Information</i>	10, 24, 25

For pricing, delivery, and ordering information, please visit Maxim Integrated's online storefront at <https://www.maximintegrated.com/en/storefront/storefront.html>.

Maxim Integrated cannot assume responsibility for use of any circuitry other than circuitry entirely embodied in a Maxim Integrated product. No circuit patent licenses are implied. Maxim Integrated reserves the right to change the circuitry and specifications without notice at any time. The parametric values (min and max limits) shown in the *Electrical Characteristics* table are guaranteed. Other parametric values quoted in this data sheet are provided for guidance.

# Mouser Electronics

Authorized Distributor

Click to View Pricing, Inventory, Delivery & Lifecycle Information:

## Maxim Integrated:

[MAX6071AAUT41+T](#) [MAX6071BAUT25+T](#) [MAX6070BAUT12+T](#) [MAX6070AAUT25+T](#) [MAX6071BAUT12+T](#)  
[MAX6070AAUT12+T](#) [MAX6070BAUT21+T](#) [MAX6071BAUT21+T](#) [MAX6071AAUT12+T](#) [MAX6070BAUT30+T](#)  
[MAX6070BAUT41+T](#) [MAX6070AAUT41+T](#) [MAX6070AAUT21+T](#) [MAX6071AAUT21+T](#) [MAX6071AAUT50+T](#)  
[MAX6071AAUT30+T](#) [MAX6071BAUT30+T](#) [MAX6070AAUT30+T](#) [MAX6071BAUT41+T](#) [MAX6071AAUT25+T](#)  
[MAX6070BAUT50+T](#) [MAX6071BAUT50+T](#) [MAX6070AAUT50+T](#) [MAX6070BAUT25+T](#) [MAX6071AAUT33+T](#)  
[MAX6071BAUT18+T](#) [MAX6070BAUT18+T](#) [MAX6070AAUT18+T](#) [MAX6071AAUT18+T](#) [MAX6070AAUT33+T](#)  
[MAX6070BAUT33+T](#) [MAX6071BAUT33+T](#) [MAX6070BAUT12/V+T](#) [MAX6070AAUT50/V+T](#) [MAX6070BAUT21/V+T](#)  
[MAX6071AAUT30/V+T](#)