

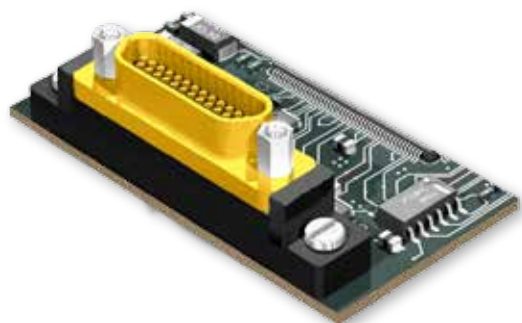

MIL-DTL-83513/22 Thru /27 Micro-D BS Straight PCB Terminated Connector



High Performance

These connectors feature goldplated TwistPin contacts for best performance. PC tails are .020 inch diameter. Specify nickel-plated shells or cadmium plated shells for best availability.

Solder-Dipped

Terminals are coated with Sn60/Pb40 tin-lead solder for best solderability.

How To Order MIL-DTL-83513 Straight PCB Micro-D Connectors

Sample Part Number	M83513/	/26-G	03	C	W
Base Part Number	M83513				
Slash Number-Shell Sizes	Plug (Pin Contacts)		Receptacle (Socket Contacts)		
	22-A - 9 Contacts 22-B - 15 Contacts 22-C - 21 Contacts 22-D - 25 Contacts 22-E - 31 Contacts 22-F - 37 Contacts 23-G - 51 Contacts 24-H - 100 Contacts (See Table I)		25-A - 9 Contacts 25-B - 15 Contacts 25-C - 21 Contacts 25-D - 25 Contacts 25-E - 31 Contacts 25-F - 37 Contacts 26-G - 51 Contacts 27-H - 100 Contacts		
PC Tail Length	01 - .109 Inch (2.77 mm) 02 - .140 Inch (3.56 mm) 03 - .172 Inch (4.37 mm)		PC Tail Length ± .015 (0.38)		
Shell Finish	C - Cadmium N - Electroless Nickel P - Passivated SST		A - Electrodeposited Aluminum K - Zinc Nickel T - Nickel Fluorocarbon Polymer		
Hardware Options	N - No Jackpost T - Threaded Insert in Board Mount Hole (No Jackposts) W - Threaded Insert in Board Mount Hole and jackposts Installed		P - Jackposts Installed		
	Shell Size 100 (H) U - #4-40 Threaded Insert Y - #4-40 Threaded Insert & Jackpost (See Table I)				

Table I: Hardware options

N	P	T or U	W or Y
<p>Thru Hole</p> <p>No Jackpost</p>	<p>Thru Hole</p> <p>Jackpost</p>	<p>Threaded Insert</p> <p>Threaded Insert</p>	<p>Threaded Insert</p> <p>Jackpost, Threaded Insert</p>

MIL-DTL-83513/22 Thru /27 Micro-D BS Straight PCB Terminated Connector



Micro-D
MIL-DTL-83513

Table II: Dimensions

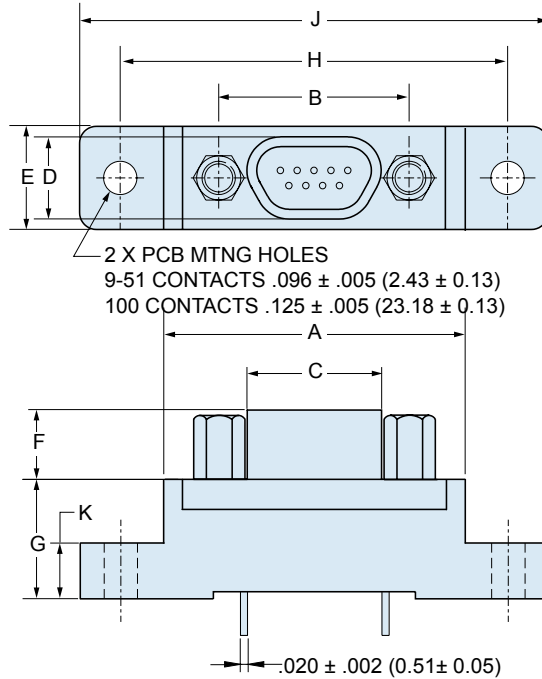

THREAD SIZES
9-51 CONTACTS #2-56 UNC
100 CONTACTS #4-40 UNC

Layout	A Max.		B		C Max.		D Max.		E Max.		F		G		H		J Max.		K	
	In.	mm.	In. ±.003	mm. ± 0.08	In.	mm.	In.	mm.	In.	mm.	In. ±.004	mm. ±0.10	In. ±.010	mm. ±0.25	In. ±.007	mm. ±0.18	In.	mm.	In. ±.010	mm. ±0.25
9P	.790	20.07	.565	14.35	.333	8.46	.184	4.67	.310	7.87	.183	4.65	.333	8.46	1.150	29.21	1.390	35.31	.155	3.94
9S	.790	20.07	.565	14.35	.400	10.16	.250	6.35	.310	7.87	.195	4.95	.333	8.46	1.150	29.21	1.390	35.31	.155	3.94
15P	.940	23.88	.715	18.16	.483	12.27	.184	4.67	.310	7.87	.183	4.65	.333	8.46	1.150	29.21	1.390	35.31	.155	3.94
15S	.940	23.88	.715	18.16	.551	14.00	.250	6.35	.310	7.87	.195	4.95	.333	8.46	1.150	29.21	1.390	35.31	.155	3.94
21P	1.180	29.97	.865	21.97	.633	16.08	.184	4.67	.310	7.87	.183	4.65	.333	8.46	1.450	36.83	1.690	42.93	.155	3.94
21S	1.180	29.97	.865	21.97	.701	17.81	.250	6.35	.310	7.87	.195	4.95	.333	8.46	1.450	36.83	1.690	42.93	.155	3.94
25P	1.275	32.39	.965	24.51	.733	18.62	.184	4.67	.310	7.87	.183	4.65	.333	8.46	1.500	38.10	1.740	44.20	.155	3.94
25S	1.275	32.39	.965	24.51	.801	20.35	.250	6.35	.310	7.87	.195	4.95	.333	8.46	1.500	38.10	1.740	44.20	.155	3.94
31P	1.575	40.01	1.115	28.32	.883	22.43	.184	4.67	.310	7.87	.183	4.65	.333	8.46	1.800	45.72	2.040	51.82	.155	3.94
31S	1.575	40.01	1.115	28.32	.951	24.16	.250	6.35	.310	7.87	.195	4.95	.333	8.46	1.800	45.72	2.040	51.82	.155	3.94
37P	1.875	47.63	1.265	32.13	1.033	26.24	.184	4.67	.310	7.87	.183	4.65	.333	8.46	2.100	53.34	2.340	59.44	.155	3.94
37S	1.875	47.63	1.265	32.13	1.101	27.96	.250	6.35	.310	7.87	.195	4.95	.333	8.46	2.100	53.34	2.340	59.44	.155	3.94
51P	1.775	45.09	1.215	30.86	.983	24.97	.228	5.79	.351	8.92	.183	4.65	.333	8.46	2.000	50.80	2.270	57.64	.155	3.94
51S	1.775	45.09	1.215	30.86	1.051	26.70	.296	7.52	.351	8.92	.195	4.95	.333	8.46	2.000	50.80	2.270	57.64	.155	3.94
100P	2.585	65.66	1.800	45.72	1.383	35.13	.270	6.86	.460	11.68	.183	4.65	.525	13.34	2.800	71.12	3.250	82.55	.293	7.44
100S	2.585	65.66	1.800	45.72	1.451	36.86	.333	8.46	.460	11.68	.195	4.95	.525	13.34	2.800	71.12	3.250	82.55	.293	7.44





MIL-DTL-83513/22 Thru /27 Micro-D BS Straight PCB Terminated Connector

M83513/22 Thru /24 PCB Layouts – Pin Connectors

Patterns shown are for connector mounting side of PC board. 9 Thru 51 Contacts .096 (2.44) Diameter Mounting Holes, 100 Pin .125 (3.18) Diameter

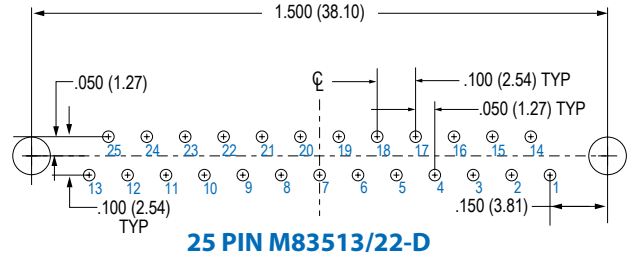
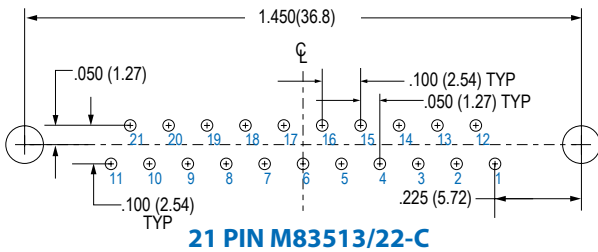
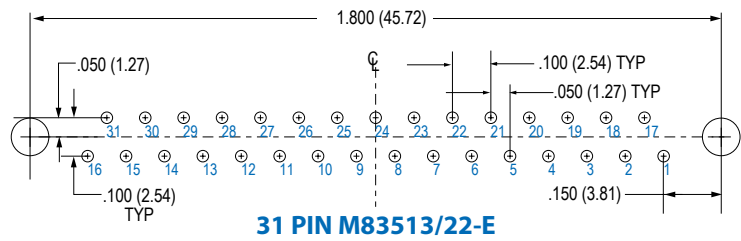
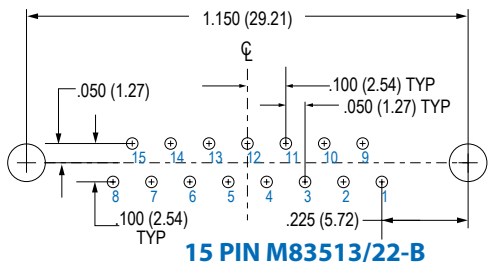
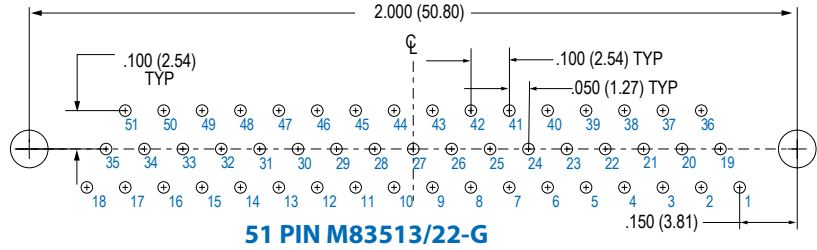
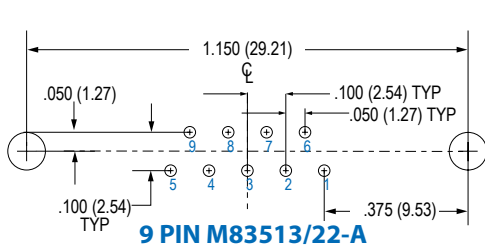

Connector Orientation

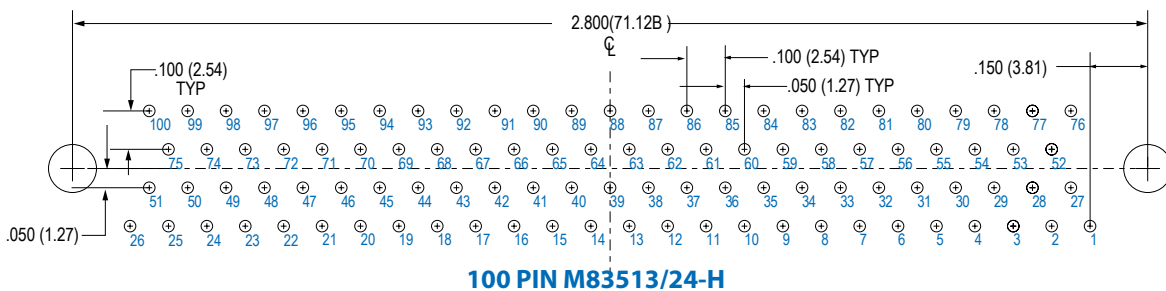
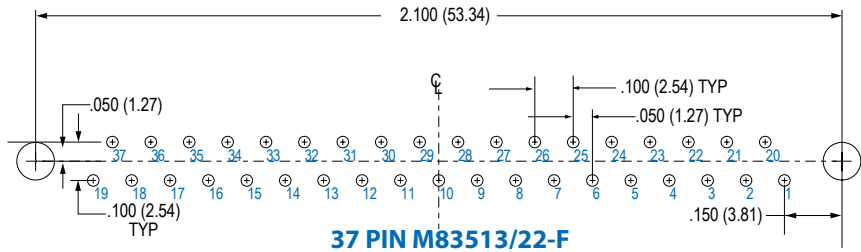
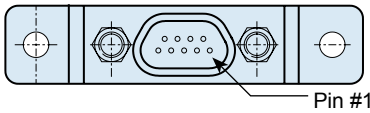

M83513/25 Thru /27 PCB Layouts – Socket Connectors

Patterns shown are for connector mounting side of PC board. 9 Thru 51 Contacts .096 (2.44) Diameter Mounting Holes, 100 Pin .125 (3.18) Diameter

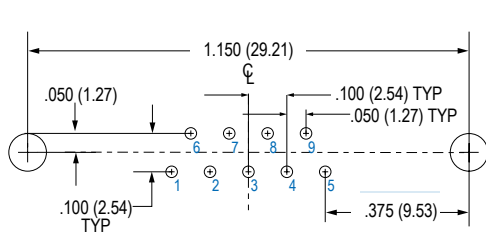

9 SOCKET M83513/25-A

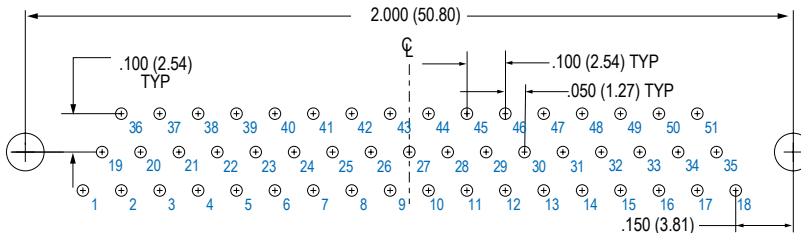

51 SOCKET M83513/26-G

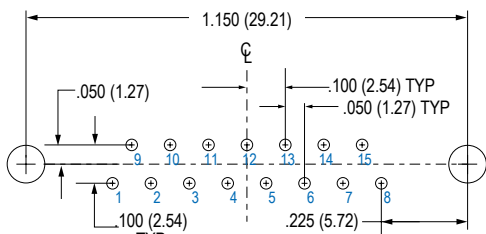

15 SOCKET M83513/25-B

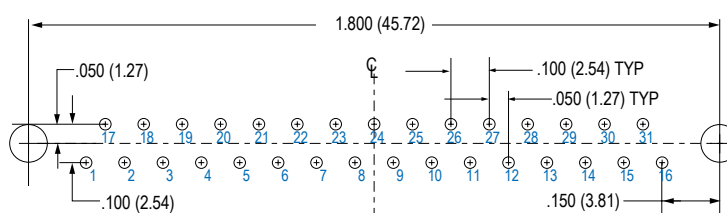

31 SOCKET M83513/25-E

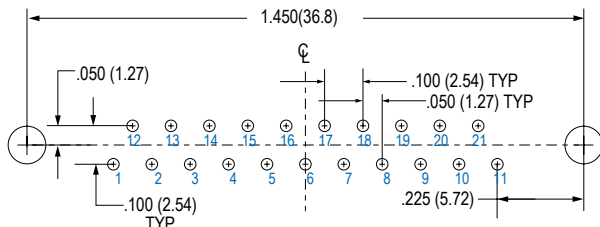

21 SOCKET M83513/25-C

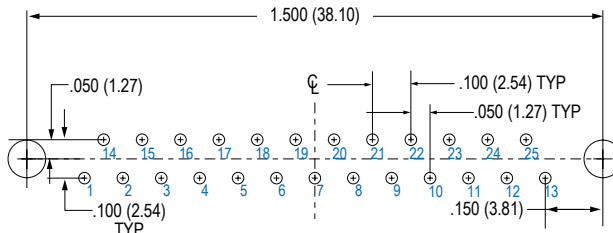

25 SOCKET M83513/25-D

Connector Orientation

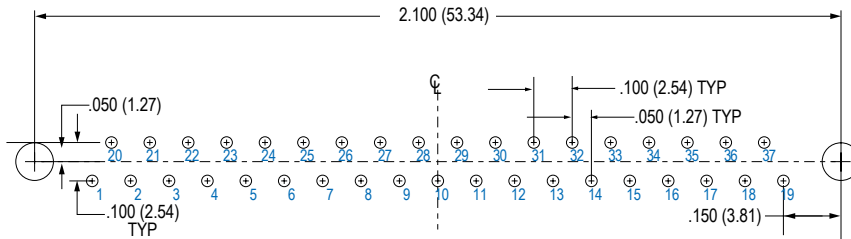
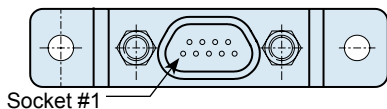

37 SOCKET M83513/25-F

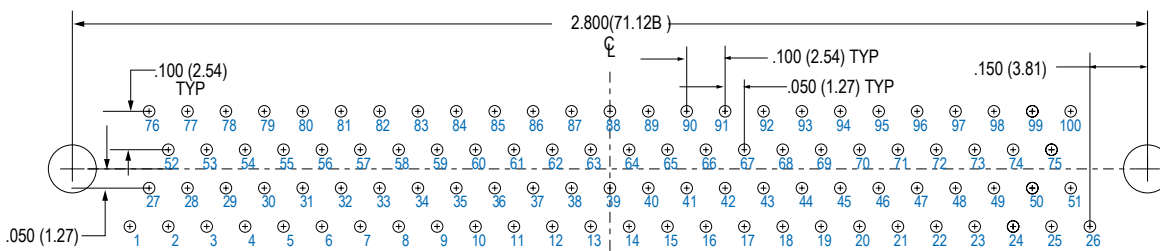

100 SOCKET M83513/27-H

Mouser Electronics

Authorized Distributor

Click to View Pricing, Inventory, Delivery & Lifecycle Information:

Glenair:

[M83513/26-G03NP](#) [M83513/25-C02CP](#) [M83513/22-B01CT](#) [M83513/25-B01CT](#) [M83513/24-H03NW](#) [M83513/23-G01NT](#) [M83513/22-D02NN](#) [M83513/22-B02NP](#) [M83513/25-B02NP](#) [M83513/23-G02CN](#) [M83513/26-G02CN](#) [M83513/22-C01NP](#) [M83513/25-B01NP](#) [M83513/27-H01CN](#) [M83513/25-C01NP](#) [M83513/25-B02CP](#) [M83513/22-D01CW](#) [M83513/22-B03NP](#) [M83513/22-A02CP](#) [M83513/25-A02CP](#) [M83513/22-D01CP](#) [M83513/22-A01CN](#) [M83513/22-A01NN](#) [M83513/22-B01CN](#) [M83513/22-B01NN](#) [M83513/22-C01CN](#) [M83513/22-C01NN](#) [M83513/22-D01NN](#) [M83513/22-E01CN](#) [M83513/22-E01NN](#) [M83513/22-F01CN](#) [M83513/22-F01CP](#) [M83513/22-F01NN](#) [M83513/23-G01CN](#) [M83513/23-G01NN](#) [M83513/24-H01CP](#) [M83513/24-H01NN](#) [M83513/24-H01NP](#) [M83513/25-A01CN](#) [M83513/25-A01NN](#) [M83513/25-B01CN](#) [M83513/25-B01NN](#) [M83513/25-C01NN](#) [M83513/25-D01CN](#) [M83513/25-D01CP](#) [M83513/25-D01NN](#) [M83513/25-E01CN](#) [M83513/25-E01NN](#) [M83513/25-F01CN](#) [M83513/25-F01CP](#) [M83513/25-F01NN](#) [M83513/25-F01NP](#) [M83513/26-G01CP](#) [M83513/26-G01NN](#) [M83513/26-G01NP](#) [M83513/27-H01CP](#) [M83513/27-H01NN](#) [M83513/27-H01NP](#) [M83513/22-A01CT](#) [M83513/22-A01CW](#) [M83513/22-A01NT](#) [M83513/22-A01PN](#) [M83513/22-A01PP](#) [M83513/22-A01PT](#) [M83513/22-A01PW](#) [M83513/22-A02CN](#) [M83513/22-A02CT](#) [M83513/22-A02CW](#) [M83513/22-A02NT](#) [M83513/22-A02PN](#) [M83513/22-A02PP](#) [M83513/22-A02PT](#) [M83513/22-A02PW](#) [M83513/22-A03CN](#) [M83513/22-A03CP](#) [M83513/22-A03CT](#) [M83513/22-A03CW](#) [M83513/22-A03NN](#) [M83513/22-A03NT](#) [M83513/22-A03NW](#) [M83513/22-A03PN](#) [M83513/22-A03PP](#) [M83513/22-A03PT](#) [M83513/22-A03PW](#) [M83513/22-B01NT](#) [M83513/22-B01NW](#) [M83513/22-B01PN](#) [M83513/22-B01PP](#) [M83513/22-B01PT](#) [M83513/22-B01PW](#) [M83513/22-B02CN](#) [M83513/22-B02CP](#) [M83513/22-B02CT](#) [M83513/22-B02CW](#) [M83513/22-B02NN](#) [M83513/22-B02NT](#) [M83513/22-B02PN](#) [M83513/22-B02PP](#) [M83513/22-B02PT](#) [M83513/22-B02PW](#)