



PSE Technology Corporation

SPECIFICATION FOR APPROVAL

CUSTOMER	_____
NOMINAL FREQUENCY	125.000000 MHz
PRODUCT TYPE	TYPE NX 7.0x5.0 SEAM SEALED CRYSTAL CLOCK OSCILLATOR
SPEC. NO. (P/N)	NX71C50001
CUSTOMER P/N	_____
ISSUE DATE	March 10, 2015
VERSION	A

APPROVED	PREPARED	QA
APPROVED BY CUSTOMER :		AVL Status
Please return one copy with approval to PSE-TW		

PSE Technology Corporation

No.2, Tzu-Chiang 5th Rd, Chung Li Industrial Park,
 Chung Li City, Taoyuan County, Taiwan (R.O.C.)
 TEL: 886-3-451-8888
 FAX: 886-3-461-3865
<http://www.saronix-ecera.com.tw>

- *Pb-free
- *RoHS Compliant
- *HF-Halogen Free
- *REACH Compliant

*** A company of PERICOM Semiconductor Corporation ***

TYPE NX 7.0x5.0 SEAM SEALED CRYSTAL CLOCK OSCILLATOR

NX71C50001

VER. A 10-Mar-15

VERSION HISTORY

Version No.	Version Date	Customer Receipt Date	Supplier Receipt Date	Description	Notes
A	Mar.10,2015			Initial Release	



TYPE NX 7.0x5.0 SEAM SEALED CRYSTAL CLOCK OSCILLATOR

NX71C50001

VER. A 10-Mar-15

ELECTRICAL SPECIFICATIONS

SRe Part Number : NX71C50001

Item	Symbol	Specifications	Units	Notes
Nominal Frequency	F ₀	125.000000	MHz	
Frequency Stability	FT	± 20	ppm	**See note
Operating Temperature Range	TR	-20 to +70	°C	
Supply Voltage	V _{DD}	+2.5 ± 5.0%	V	
Logic Type	LT	LVC MOS		
Supply Current, Output Enabled	I _{DD} /OE	60	mA	Max.
Supply Current, Output Disabled	I _{DD} /OD	40	mA	Max.
Duty Cycle (Symmetry)	DC/SY	47.5 / 52.5	%	Measured 50% of Waveform
Rise / Fall Time	T _R /T _F	3	ns	Max. measured 20/80% of Waveform
Output Voltage "0" Level	V _{OL}	0.4	V	Max.
Output Voltage "1" Level	V _{OH}	V _{DD} -0.4	V	Min.
Output Load	CL	15	pF	Max
Jitter, Phase	RMS	0.4 / 0.6	ps	Typ / Max, 12KHz ~ 20MHz Frequency Band
Jitter, Accumulated	RMS(1-σ)	6	ps	Max, 20,000 Consecutive Periods
Jitter, Peak to Peak	Pk-Pk	40	ps	Max, 100,000 Random Periods
Storage Temperature Range		-55 to +125	°C	

※ This product doesn't include harmful substance that stipulated by SONY SS-00259 Level 1 and S-AT2-001 Level 1 standard. RoHS Compliant (Pb - Free).

**Stability includes all combinations of Operating Temperature, Load changes, rated Input (Supply) Voltage changes, Initial Calibration Tolerance (25°C), Aging (1 year at 25°C Average Effective Ambient Temperature), Shock and Vibration.

Output Enable / Disable Function

Parameter	Min.	Typ.	Max.	Units	Notes
Input Voltage (Pin1), Output Enable	0.7V _{DD}			V	Or Open
Input Voltage (Pin1), Output Disable (low power standby)			0.3V _{DD}	V	Output is Hi-Z
Output Disable Delay			100	ns	
Output Enable Delay			100	ns	
Start Up Time			10	ms	

TYPE NX 7.0x5.0 SEAM SEALED CRYSTAL CLOCK OSCILLATOR

NX71C50001

VER. A 10-Mar-15

TEST CIRCUIT

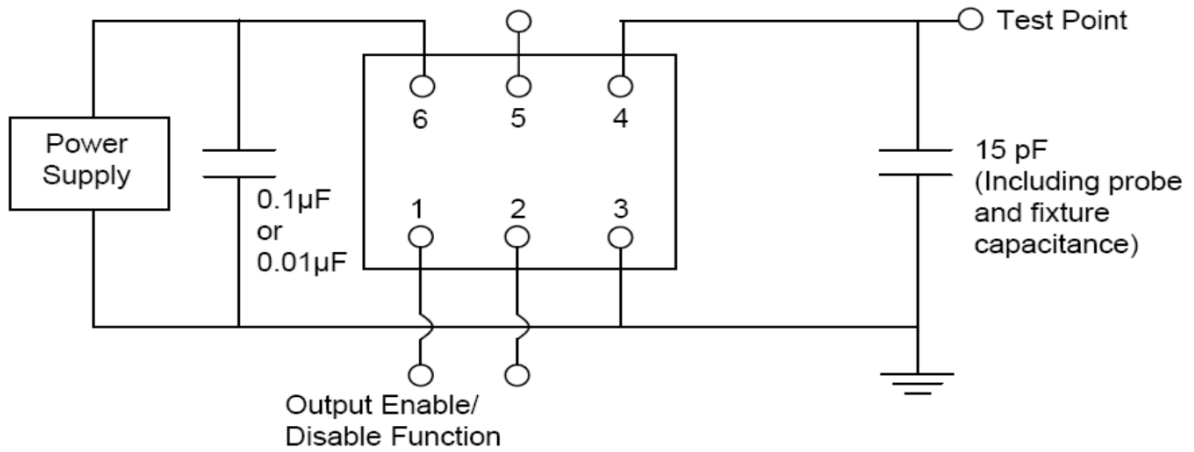

OUTPUT WAVEFORM

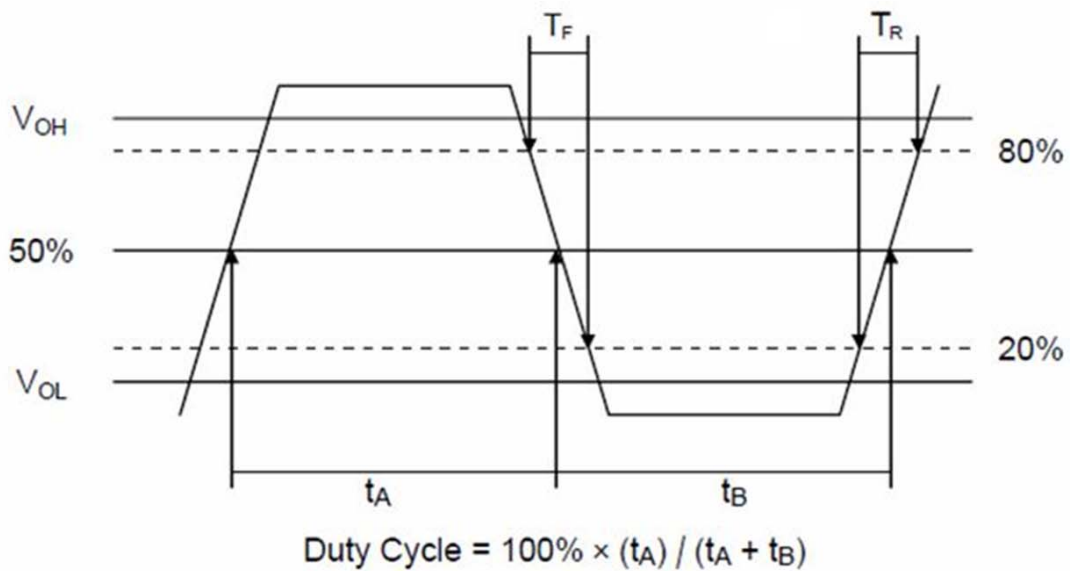

TYPE NX 7.0x5.0 SEAM SEALED CRYSTAL CLOCK OSCILLATOR

NX71C50001

VER. A 10-Mar-15

RELIABILITY SPECIFICATIONS

ENVIRONMENTAL:

- a) THERMAL SHOCK: MIL-STD-883, Method 1011, Condition A
- b) MOISTURE RESISTANCE: MIL-STD-883, Method 1004
- c) VIBRATION: MIL-STD-883, Method 2007, Condition A
- d) RESISTANCE TO SOLDERING HEAT: J-STD-020D Table 5-2 Pb-free devices (except 2 cycles max)
- e) HAZARDOUS SUBSTANCE: Pb - free and RoHS Compliant.

MECHANICAL:

- a) SHOCK: MIL-STD-883, Method 2002, Condition B
- b) SOLDERABILITY: JESD22-B102-D Method 2 (Preconditioning E)
- c) TERMINAL STRENGTH: MIL-STD-883, Method 2004, Test Condition D
- d) GROSS LEAK: MIL-STD-883, Method 1014, Condition C
- e) FINE LEAK: MIL-STD-883, Method 1014, Condition A2, $R1=2 \times 10^{-8}$ atm cc/s
- f) SOLVENT RESISTANCE: MIL-STD-202, Method 215

SUGGESTED IR REFLOW PROFILE

*As per IPC-JEDEC J-STD-020D

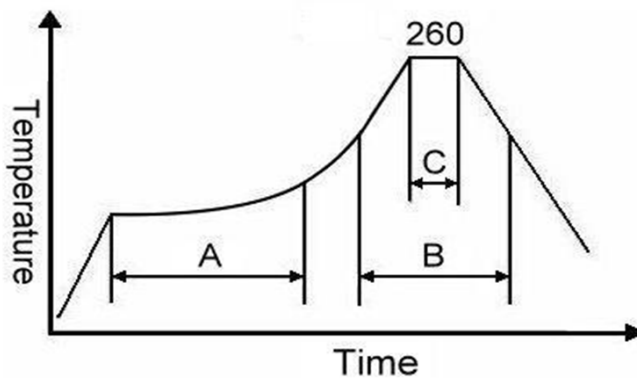

Note:

	Stage	Temperature	Time
A	Preheat	150~200°C	60~120 Sec
B	Primary Heat	217°C	60~150 Sec
C	Peak	260°C	10 Sec

For soldering reflow profile and reliability test ratings go to: <http://www.pericom.com/pdf/sre/reflow.pdf>

TYPE NX 7.0x5.0 SEAM SEALED CRYSTAL CLOCK OSCILLATOR

NX71C50001

VER. A 10-Mar-15

MARKING

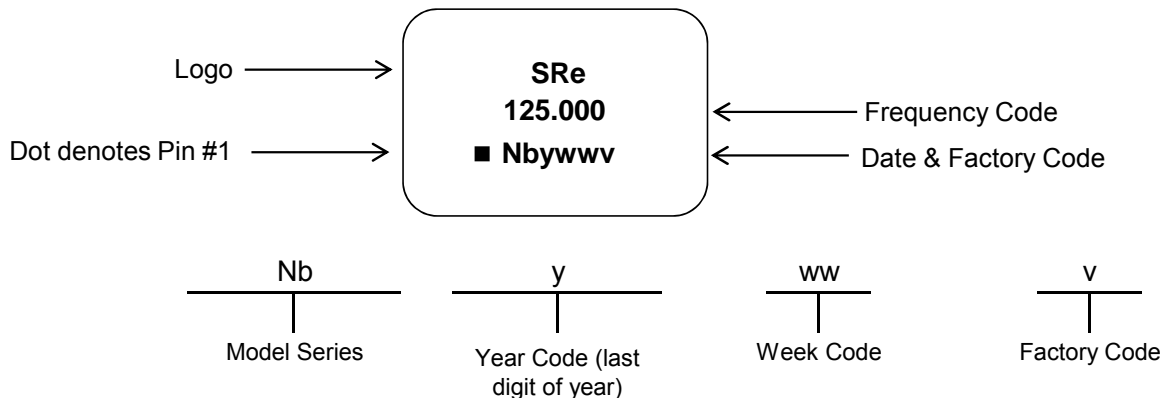

MECHANICAL DRAWINGS (Scale:None. Dimensions are in mm.)

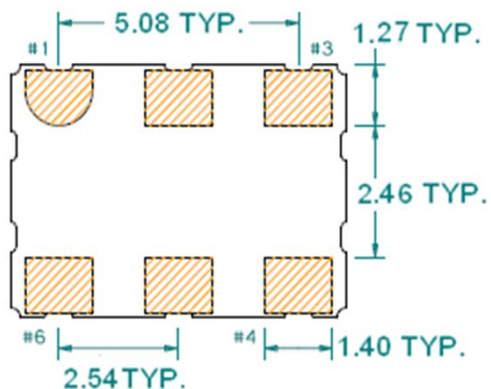
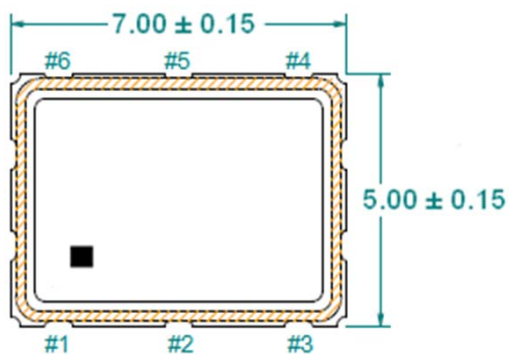

Recommended Land Pattern*

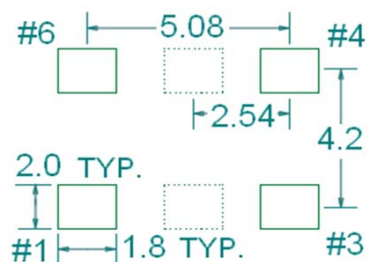

*Note: pads 2 and 5 are optional (shown as dotted lines). XO's are designed to fit on industry standard, 4 pad layouts.

Pin	Function
1	OE Function
2	N/C
3	Ground
4	Output
5	N/C
6	V _{DD}

*Extended high frequency power decoupling is recommended (see test circuit for minimum recommendation). To ensure optimal performance, do not route RF traces beneath the package.

TYPE NX 7.0x5.0 SEAM SEALED CRYSTAL CLOCK OSCILLATOR

NX71C50001

VER. A 10-Mar-15

TAPE&REEL

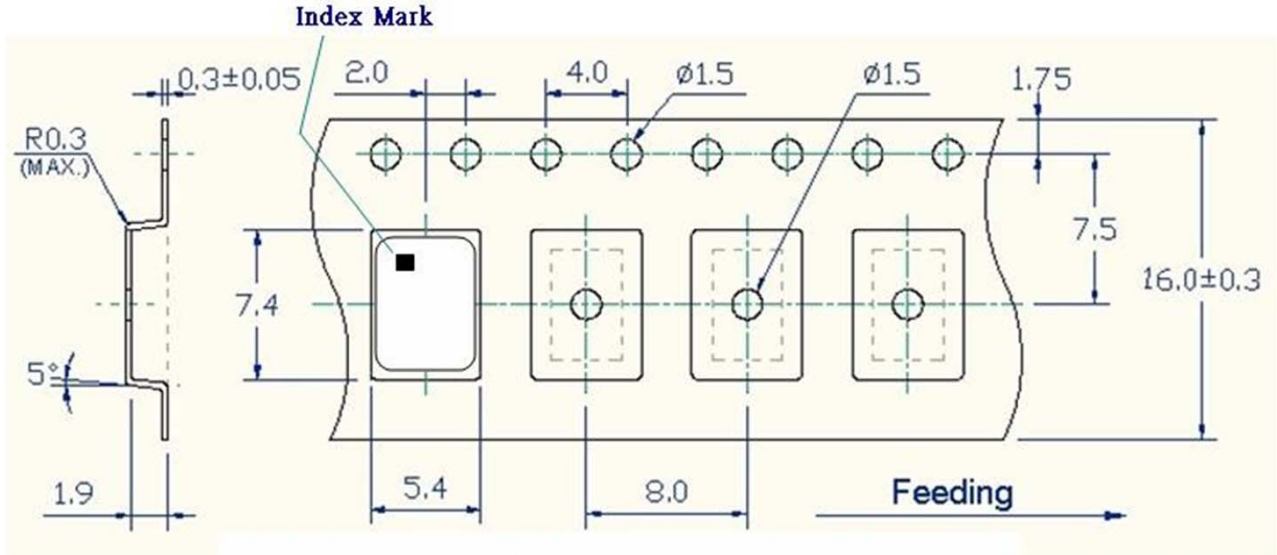

1. 230mm minimum leader which consist of carrier and/or tape followed by a minimum of 160mm of empty carrier tape sealed with cover tape.
2. 160mm minimum trailer of empty carrier tape sealed with cover tape.

TYPE NX 7.0x5.0 SEAM SEALED CRYSTAL CLOCK OSCILLATOR

NX71C50001

VER. A 10-Mar-15

PACKING

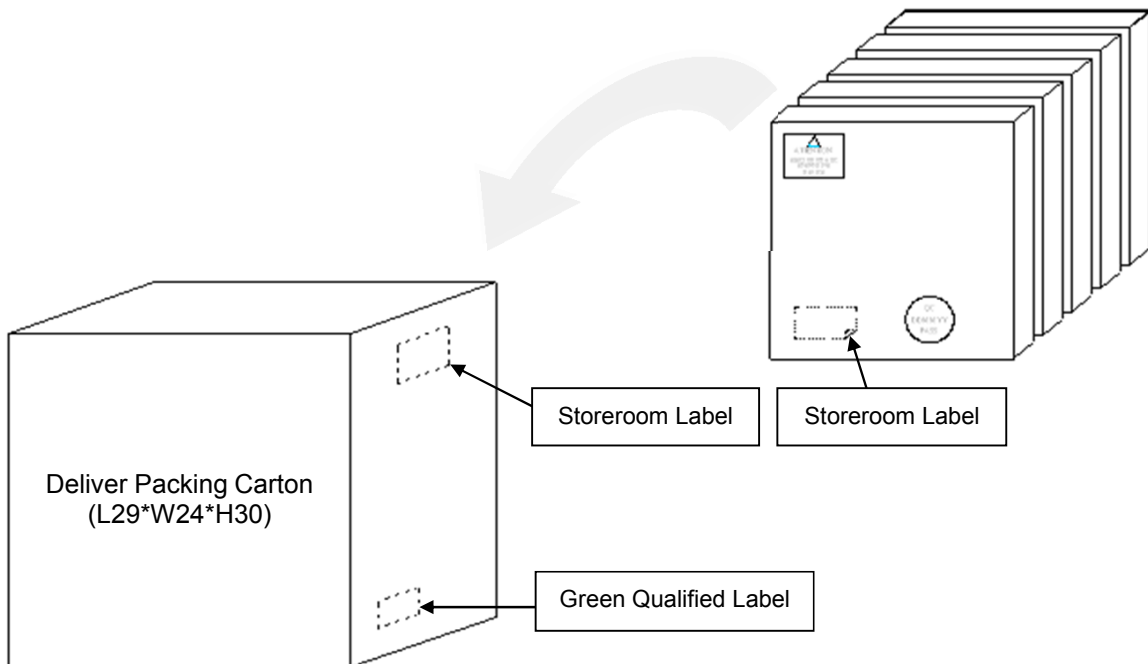
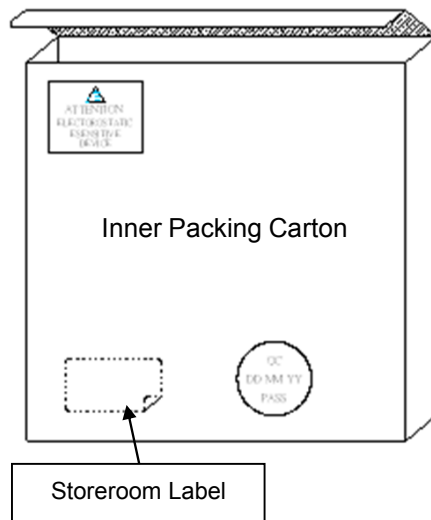
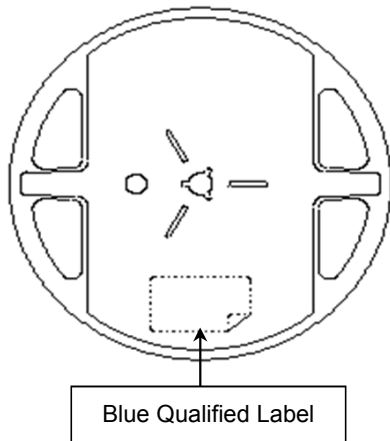
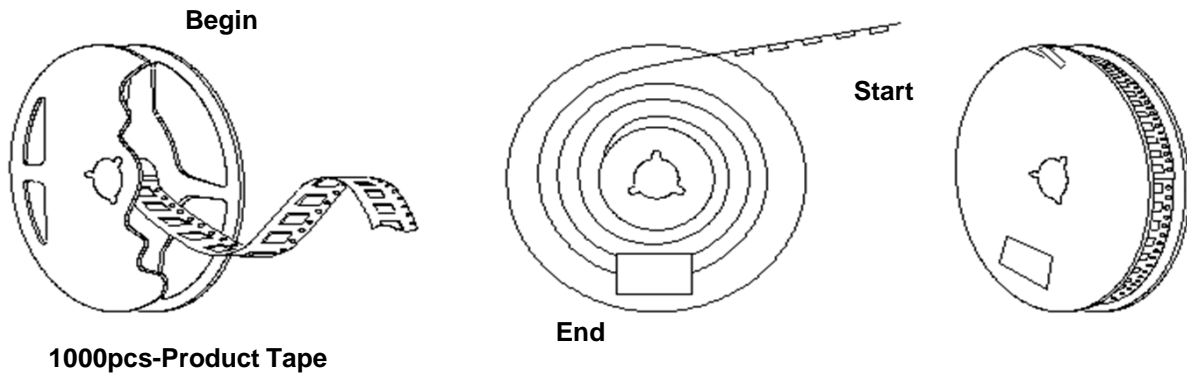

Mouser Electronics

Authorized Distributor

Click to View Pricing, Inventory, Delivery & Lifecycle Information:

[Diodes Incorporated:](#)

[FDC500017](#) [SEL3935B-125.0000T](#)