

PLEASE CHECK WWW.MOLEX.COM FOR LATEST PART INFORMATION

Part Number: [0908160012](#)
Status: **Active**
Overview: [Picoflex Ribbon-Cable Connectors](#)
Description: Picoflex Surface Mount Latched Vertical Header with PCB Pegs, 12 Circuits, Tin (Sn) Plating, Black

Documents:

3D Model	Product Specification TS-90816-001-001 (PDF)
Drawing (PDF)	Packaging Specification PK-90816-001-001 (PDF)
Product Specification PS-99020-0011-001 (PDF)	RoHS Certificate of Compliance (PDF)

General

Product Family	PCB Headers
Series	90816
Application	Signal, Wire-to-Board
Overview	Picoflex Ribbon-Cable Connectors
Product Name	Picoflex
UPC	883906498849

Physical

Breakaway	No
Circuits (Loaded)	12
Circuits (maximum)	12
Color - Resin	Black
Durability (mating cycles max)	5
First Mate / Last Break	No
Glow-Wire Capable	No
Guide to Mating Part	No
Keying to Mating Part	N/A
Lock to Mating Part	Yes
Material - Metal	Brass
Material - Plating Mating	Tin
Material - Plating Termination	Nickel
Material - Resin	Nylon
Net Weight	0.588/g
Number of Rows	1
Orientation	Vertical
PC Tail Length	1.05mm
PCB Locator	Yes
PCB Retention	None
PCB Thickness - Recommended	1.60mm
Packaging Type	Tube
Pitch - Mating Interface	1.27mm
Pitch - Termination Interface	1.27mm
Plating min - Mating	0.076µm
Polarized to Mating Part	Yes
Polarized to PCB	Yes
Shrouded	Partial
Stackable	No
Surface Mount Compatible (SMC)	Yes
Temperature Range - Operating	-40° to +105°C
Termination Interface: Style	Surface Mount

Electrical

Current - Maximum per Contact	1.2A
Voltage - Maximum	250V

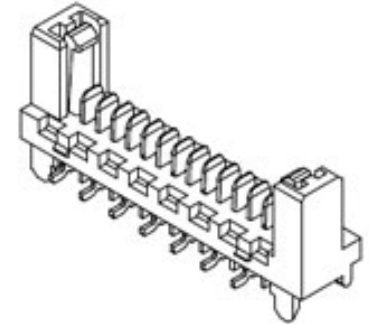

Series image - Reference only

EU ELV

Not Relevant

EU RoHS

Compliant

REACH SVHC

Not Contained Per -
ED/61/2018 (27 June
2018)

Halogen-Free

Status

Low-Halogen

For more information, please visit [Contact US](#)

China ROHS

ELV

RoHS Phthalates

China RoHS

Green Image

Not Relevant

Not Contained

Search Parts in this Series

[90816 Series](#)

Mates With

[90327 Picoflex PF-50](#)

Material Info

Reference - Drawing Numbers

Packaging Specification

Product Specification

Sales Drawing

PK-90816-001-001

PS-99020-0011-001, TS-90816-001-001

SD-90816-001

This document was generated on 10/10/2018

PLEASE CHECK WWW.MOLEX.COM FOR LATEST PART INFORMATION

Mouser Electronics

Authorized Distributor

Click to View Pricing, Inventory, Delivery & Lifecycle Information:

[Molex:](#)

[90816-0012](#)