



# 92x92x38 mm

San Ace 92 9GV type

## General Specifications

- Material ..... Frame: Plastic (Flammability: UL 94V-0), Impeller: Plastic (Flammability: UL 94V-1)
- Expected life ..... See the table below. (L10 life: 90% survival rate for continuous operation in free air at 60°C, rated voltage)
- Motor protection function ..... Locked rotor burnout protection, Reverse polarity protection  
For details, please refer to p. 547.
- Dielectric strength ..... 50/60 Hz, 500 VAC, for 1 minute (between lead wire conductors and frame)
- Insulation resistance ..... 10 MΩ or more with a 500 VDC megger (between lead wire conductors and frame)
- Sound pressure level (SPL) ..... At 1 m away from the air inlet
- Storage temperature ..... -30 to +70°C (Non-condensing)
- Lead wire ..... ⊕Red ⊖Black (Sensor) Yellow (Control) Brown
- Mass ..... 250 g

## Specifications

The models listed below **have ribs and pulse sensors with PWM control function.** For models without ribs, append "1" to the end of model numbers.

Model no.	Rated voltage [V]	Operating voltage range [V]	PWM duty cycle* [%]	Rated current [A]	Rated input [W]	Rated speed [min <sup>-1</sup> ]	Max. airflow [m <sup>3</sup> /min] [CFM]	Max. static pressure [Pa] [inchH <sub>2</sub> O]	SPL [dB (A)]	Operating temperature [°C]	Expected life [h]			
9GV0912P1G03	12	10.8 to 13.2	100	4.1	49.2	9000	5.35 189.0	430.0 1.73	68	-20 to +70	40000/60°C			
			0	0.33	4.0	2900	1.72 60.8	44.6 0.18	37					
10.2 to 13.8		100	3.5	42.0	8500	5.05 178.0	385.0 1.55	64						
		0	0.29	3.5	2700	1.6 56.5	38.8 0.16	34						
		100	1.9	22.8	7000	4.15 146.6	261 1.05	59						
		0	0.16	1.92	2200	1.3 45.9	25.7 0.1	31						
9GV0948P1H03	48	40.8 to 55.2	100	0.82	39.4	8500	5.05 178.0	385.0 1.55	64	-20 to +70	40000/60°C			
			0	0.14	6.7	4000	2.37 83.7	85.2 0.34	45					
40.8 to 55.2		100	0.48	23.04	7000	4.15 146.6	261 1.05	59						
		0	0.12	5.76	3500	2.07 73.1	65.2 0.26	42						
		9GV0948P1F03	40.8 to 55.2	100	0.48	23.04	7000	4.15 146.6	261 1.05			59	-10 to +70	40000/60°C
				0	0.12	5.76	3500	2.07 73.1	65.2 0.26			42		

\* PWM frequency: 25 kHz

The following sensor and control options are available for selection.

Differs according to the model. Refer to the table on p. 574. Without sensor Pulse sensor Lock sensor

## Airflow - Static Pressure Characteristics / PWM Duty - Speed Characteristics Example

**9GV0912P1G03** With pulse sensor with PWM control function

PWM duty cycle

Operating voltage range

PWM duty - Speed characteristics example

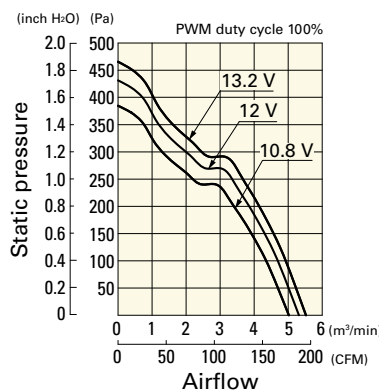
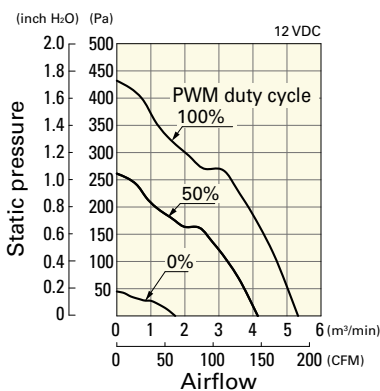

### Airflow - Static Pressure Characteristics / PWM Duty - Speed Characteristics Example

**9GV0912P1H03** With pulse sensor with PWM control function

PWM duty cycle

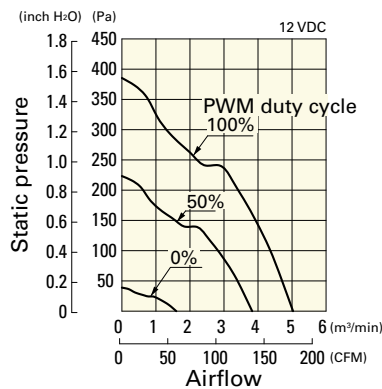

Operating voltage range

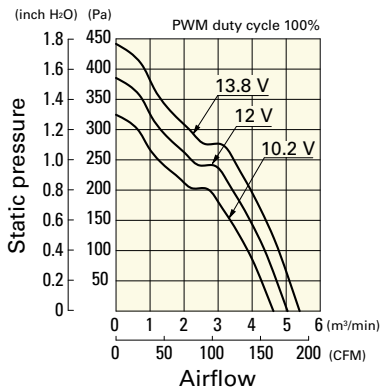

PWM duty - Speed characteristics example

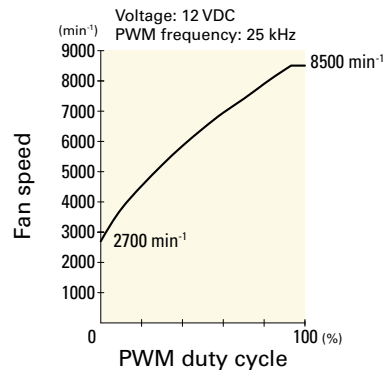

**9GV0912P1F03** With pulse sensor with PWM control function

PWM duty cycle

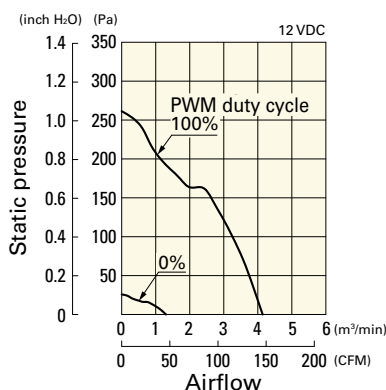

Operating voltage range

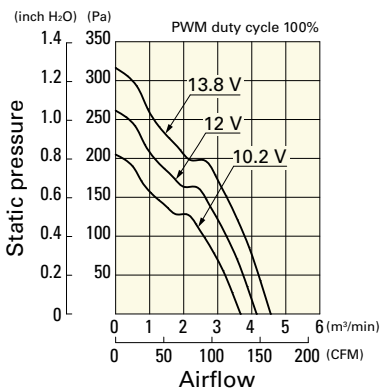

PWM duty - Speed characteristics example

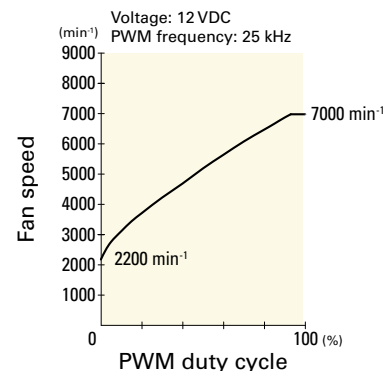

**9GV0948P1H03** With pulse sensor with PWM control function

PWM duty cycle

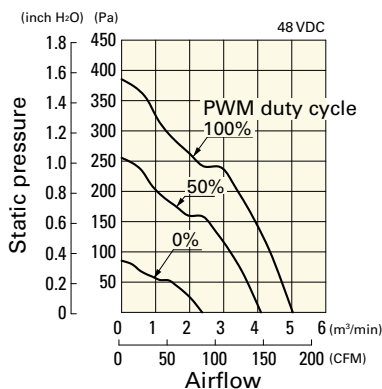

Operating voltage range

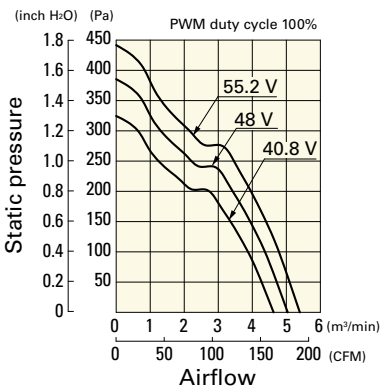

PWM duty - Speed characteristics example

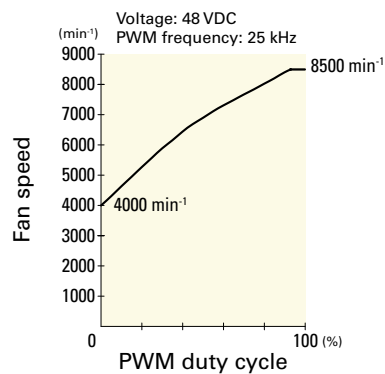

**9GV0948P1F03** With pulse sensor with PWM control function

PWM duty cycle

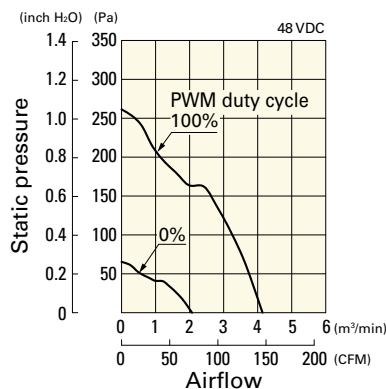

Operating voltage range

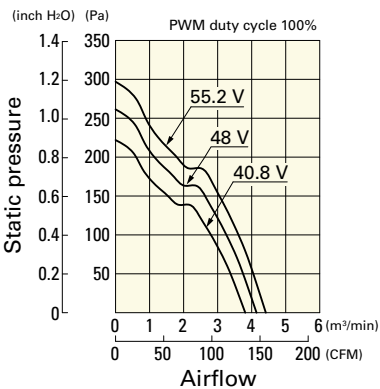

PWM duty - Speed characteristics example

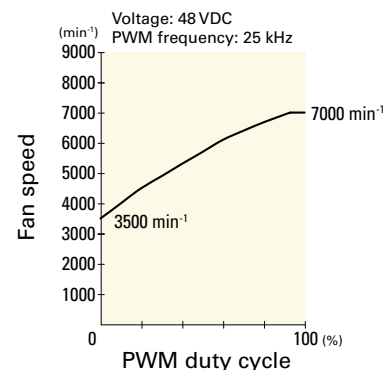

**Dimensions (unit: mm)** (With ribs)

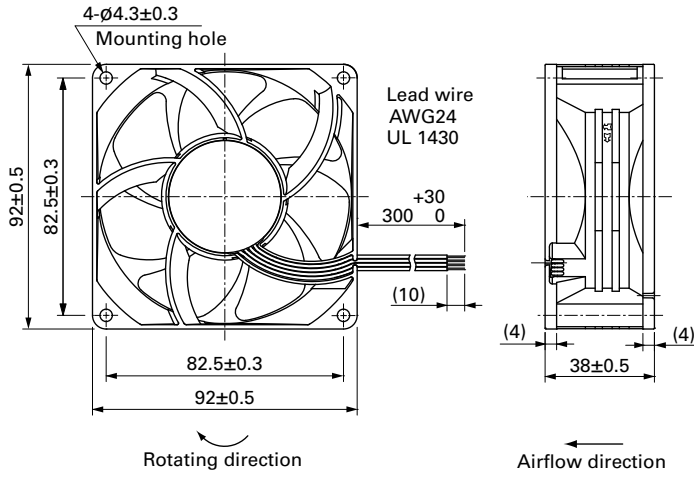

**Reference Dimensions of Mounting Holes and Vent Opening (unit: mm)**

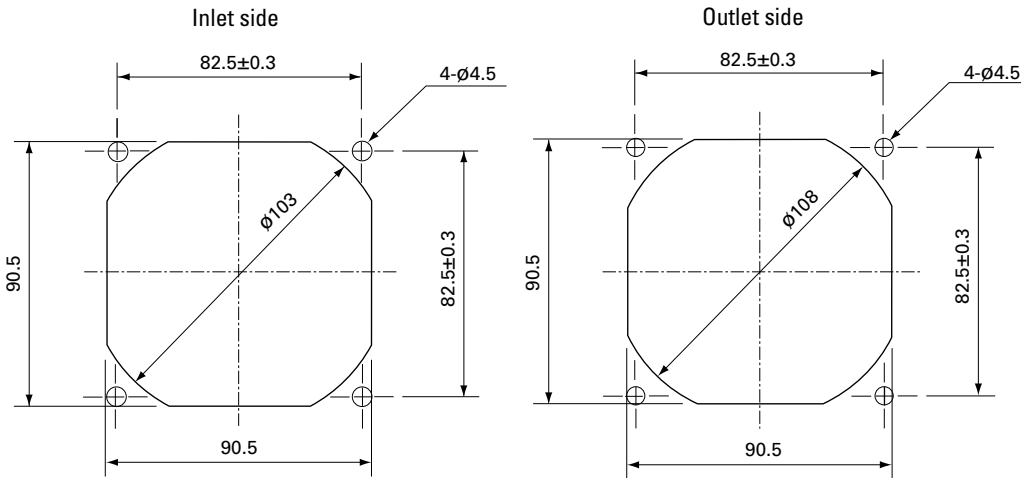

**Options**

**Finger guards**

page: p. 532

Model no.: 109-099E, 109-099H, 109-099C

**Resin finger guards**

page: p. 539

Model no.: 109-1001G

**Resin filter kits**

page: p. 540

Model no.: 109-1001F13 (13PPI), 109-1001F20 (20PPI),  
109-1001F30 (30PPI), 109-1001F40 (40PPI)

# Mouser Electronics

Authorized Distributor

Click to View Pricing, Inventory, Delivery & Lifecycle Information:

## Sanyo Denki:

[9GV0912P1H031](#) [9GV0948P1H031](#) [9GV0912P1G031](#) [9GV0912P1H03](#) [9GV0912P1G03](#) [9GV0948P1H03](#)  
[9GV0912H102](#) [9GV0948H101](#) [9GV0948H102](#) [9GV0948H1021](#) [9GV0912G101](#) [9GV0912G102](#) [9GV0912H101](#)  
[9GV0912P1F03](#) [9GV0948P1F03](#) [9GV0948P1F031](#) [9GV0912P1F031](#) [9GV0912H1D01](#)