

MMIC VCO w/ BUFFER AMPLIFIER, 6.8 - 7.4 GHz



Typical Applications

Low noise MMIC VCO w/Buffer Amplifier for:

- VSAT & Microwave Radio
- Test Equipment & Industrial Controls
- Military

Features

- Pout: +11dBm
- Phase Noise: -106 dBc/Hz @100 kHz
- No External Resonator Needed
- Single Supply: +3V @ 80 mA
- QFN Leadless SMT Package, 16mm²

Functional Diagram

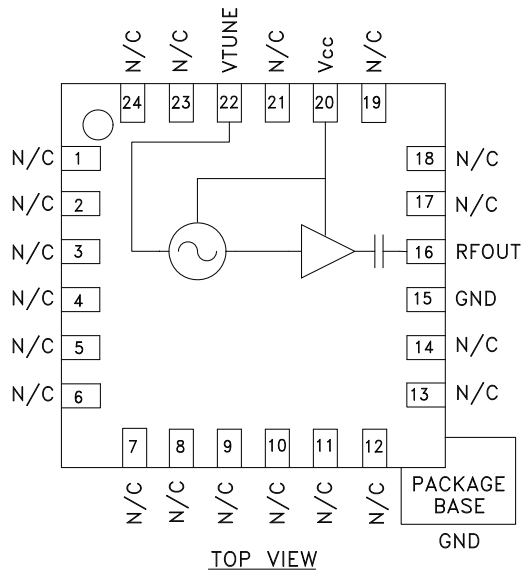

General Description

The HMC505LP4 & HMC505LP4E are GaAs InGaP Heterojunction Bipolar Transistor (HBT) MMIC VCOs with integrated resonators, negative resistance devices, varactor diodes, and buffer amplifiers. Covering 6.8 to 7.4 GHz, the VCO's phase noise performance is excellent over temperature, shock and vibration due to the oscillator's monolithic structure. Power output is +11 dBm typical from a single supply of +3V @ 80 mA. The voltage controlled oscillator is packaged in a leadless QFN 4x4 mm surface mount package.

Electrical Specifications, $T_A = +25^\circ \text{C}$, $V_{cc} = +3\text{V}$

Parameter	Min.	Typ.	Max.	Units
Frequency Range	6.8 - 7.4			GHz
Power Output	8	11		dBm
SSB Phase Noise @ 100 kHz Offset, $V_{tune} = +5\text{V}$ @ RF Output		-106		dBc/Hz
Tune Voltage (V_{tune})	1		11	V
Supply Current (I_{cc}) ($V_{cc} = +3.0\text{V}$)		80		mA
Tune Port Leakage Current			10	μA
Output Return Loss		9		dB
Harmonics				
2nd		-19		dBc
3rd		-28		dBc
Pulling (into a 2.0:1 VSWR)		6		MHz/pp
Pushing @ $V_{tune} = +5\text{V}$		20		MHz/V
Frequency Drift Rate		0.8		MHz/ $^\circ\text{C}$

Information furnished by Analog Devices is believed to be accurate and reliable. However, no responsibility is assumed by Analog Devices for its use, nor for any infringements of patents or other rights of third parties that may result from its use. Specifications subject to change without notice. No license is granted by implication or otherwise under any patent or patent rights of Analog Devices. Trademarks and registered trademarks are the property of their respective owners.

For price, delivery, and to place orders: Analog Devices, Inc., One Technology Way, P.O. Box 9106, Norwood, MA 02062-9106
Phone: 781-329-4700 • Order online at www.analog.com
Application Support: Phone: 1-800-ANALOG-D



**MMIC VCO w/ BUFFER
AMPLIFIER, 6.8 - 7.4 GHz**

Frequency vs. Tuning Voltage, $T = 25^{\circ}\text{C}$

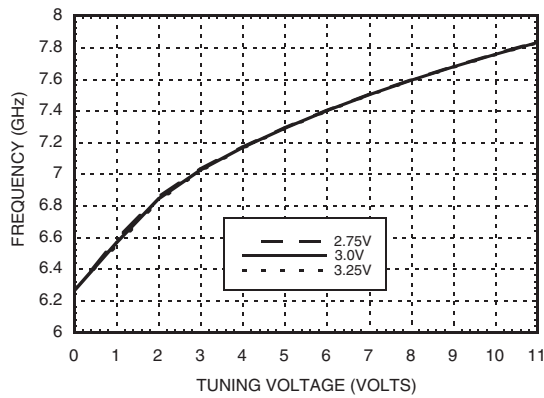

Frequency vs. Tuning Voltage, $V_{cc} = +3V$

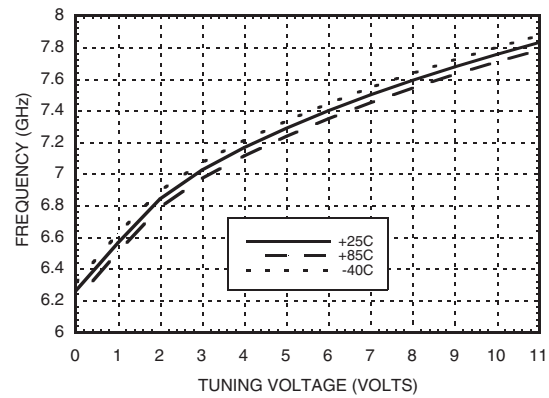

Sensitivity vs. Tuning Voltage, $V_{cc} = +3V$

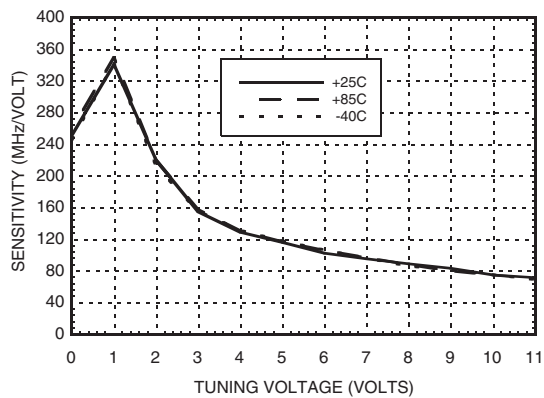

**Output Power vs.
Tuning Voltage, $V_{cc} = +3V$**

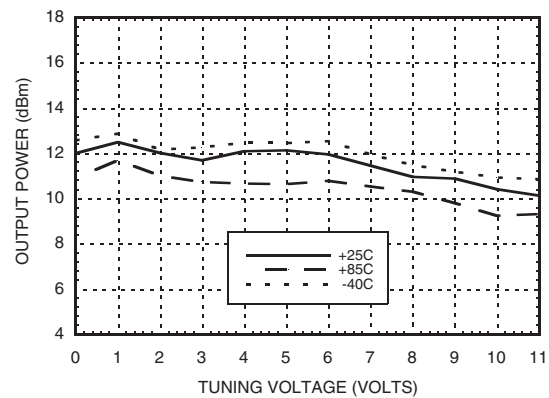

Phase Noise vs. Tuning Voltage

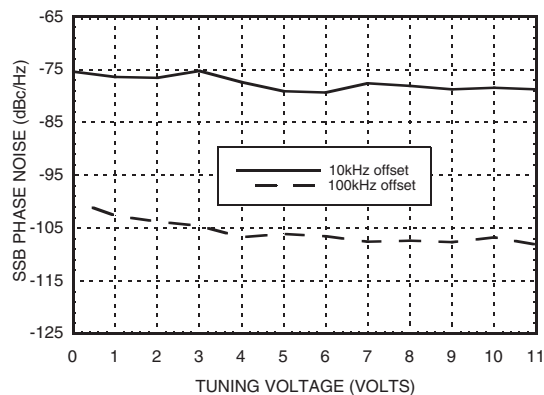

Typical SSB Phase Noise @ $V_{tune} = +5V$

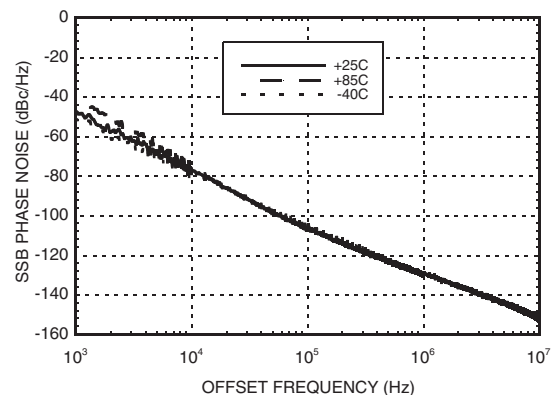

Information furnished by Analog Devices is believed to be accurate and reliable. However, no responsibility is assumed by Analog Devices for its use, nor for any infringements of patents or other rights of third parties that may result from its use. Specifications subject to change without notice. No license is granted by implication or otherwise under any patent or patent rights of Analog Devices. Trademarks and registered trademarks are the property of their respective owners.

For price, delivery, and to place orders: Analog Devices, Inc., One Technology Way, P.O. Box 9106, Norwood, MA 02062-9106 Phone: 781-329-4700 • Order online at www.analog.com Application Support: Phone: 1-800-ANALOG-D

MMIC VCO w/ BUFFER AMPLIFIER, 6.8 - 7.4 GHz



Absolute Maximum Ratings

Vcc	+3.5 Vdc
Vtune	0 to +11V
Channel Temperature	135 °C
Continuous Pdiss (T = 85°C) (derate 6.31 mW/°C above 85°C)	315 mW
Thermal Resistance (R _{TH}) (junction to package base)	158 °C/W
Storage Temperature	-65 to +150 °C
Operating Temperature	-40 to +85 °C
ESD Sensitivity (HBM)	Class 1A

Typical Supply Current vs. Vcc

Vcc (V)	Icc (mA)
2.75	70
3.0	80
3.25	90

Note: VCO will operate over full voltage range shown above.



**ELECTROSTATIC SENSITIVE DEVICE
OBSERVE HANDLING PRECAUTIONS**

11

VCOs & PLOs - SMT

Outline Drawing

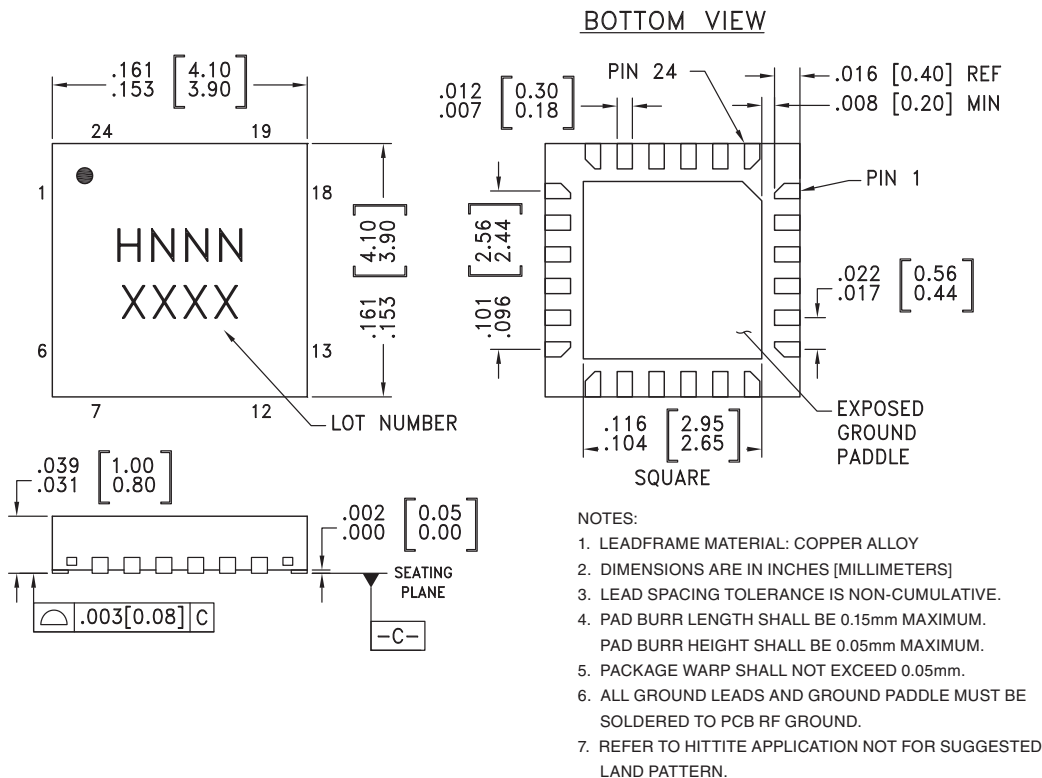

Package Information



Part Number	Package Body Material	Lead Finish	MSL Rating	Package Marking ^[3]
HMC505LP4	Low Stress Injection Molded Plastic	Sn/Pb Solder	MSL1 ^[1]	H505 XXXX
HMC505LP4E	RoHS-compliant Low Stress Injection Molded Plastic	100% matte Sn	MSL1 ^[2]	H505 XXXX

[1] Max peak reflow temperature of 235 °C

[2] Max peak reflow temperature of 260 °C

[3] 4-Digit lot number XXXX

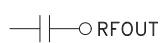
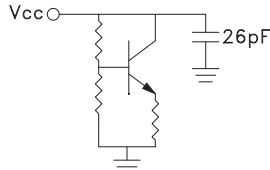
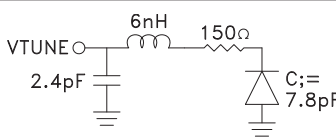

**MMIC VCO w/ BUFFER
AMPLIFIER, 6.8 - 7.4 GHz**
Pin Descriptions

Pin Number	Function	Description	Interface Schematic
1- 14, 17 - 19, 21, 23, 24	N/C	No Connection. These pins may be connected to RF ground. Performance will not be affected.	
15	GND	This pin must be connected to RF & DC ground.	
16	RFOUT	RF output (AC coupled)	
20	Vcc	Supply Voltage Vcc= 3V	
22	VTUNE	Control Voltage Input. Modulation port bandwidth dependent on drive source impedance.	
	GND	Package bottom has an exposed metal paddle that must be RF & DC grounded.	

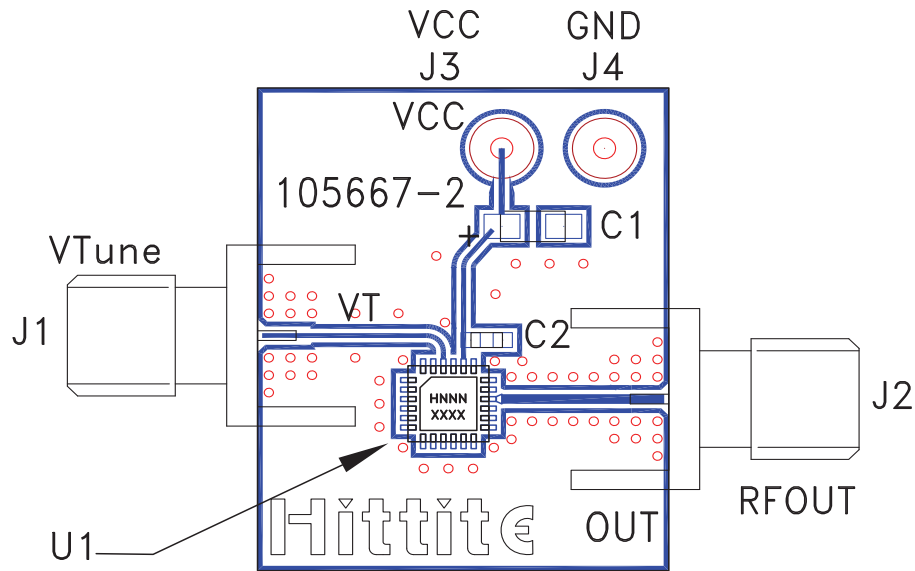

**MMIC VCO w/ BUFFER
AMPLIFIER, 6.8 - 7.4 GHz**

Evaluation PCB



List of Materials for Evaluation PCB 105706 [1]

Item	Description
J1 - J2	PCB Mount SMA RF Connector
J3 - J4	DC Pin
C1	4.7 μF Tantalum Capacitor
C2	10,000 pF Capacitor, 0603 Pkg.
U1	HMC505LP4 / HMC505LP4E VCO
PCB [2]	105667 Eval Board

[1] Reference this number when ordering complete evaluation PCB

[2] Circuit Board Material: Rogers 4350

The circuit board used in the final application should use RF circuit design techniques. Signal lines should have 50 ohm impedance while the package ground leads and exposed paddle should be connected directly to the ground plane similar to that shown. A sufficient number of via holes should be used to connect the top and bottom ground planes. The evaluation circuit board shown is available from Hittite upon request.

**MMIC VCO w/ BUFFER
AMPLIFIER, 6.8 - 7.4 GHz****Notes:**

Mouser Electronics

Authorized Distributor

Click to View Pricing, Inventory, Delivery & Lifecycle Information:

[Analog Devices Inc.:](#)

[HMC505LP4E](#) [HMC505LP4](#) [HMC505LP4ETR](#) [105706-HMC505LP4](#) [HMC505LP4TR](#)