

THIS DOCUMENT IS THE PROPERTY OF KEYSTONE ELECTRONICS CORP. AND SHALL NOT BE REPRODUCED, DISTRIBUTED OR USED AS A BASIS FOR MANUFACTURE WITHOUT PRIOR WRITTEN PERMISSION FROM KEYSTONE ELECTRONICS CORP.

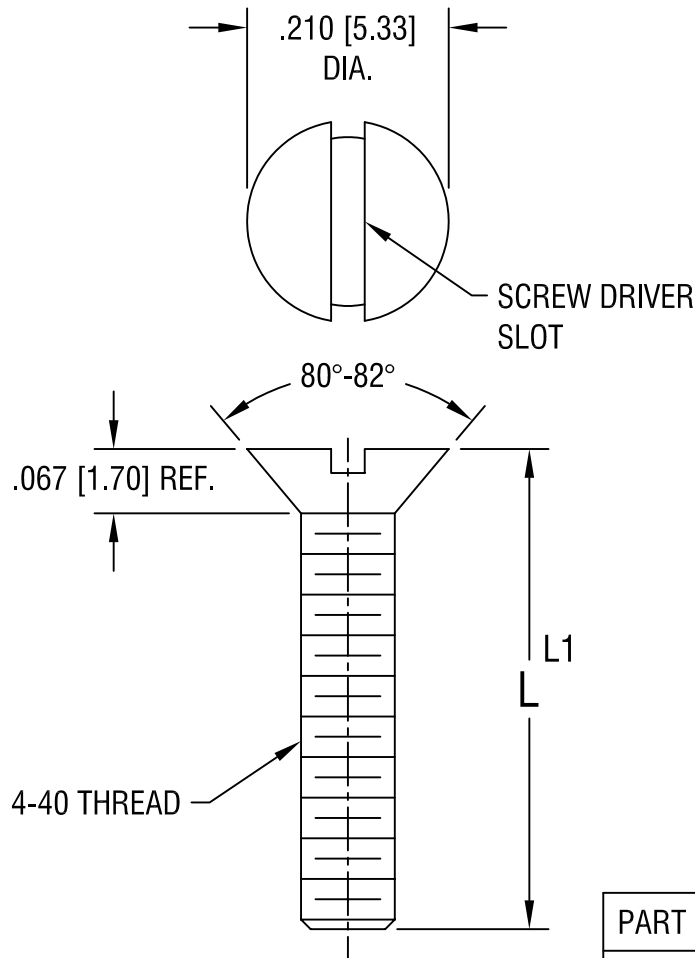

PART NO.	'L' DIM.	'L1' TOL. +0.0
9500	.250 [6.25]	-.020 [-0.50]
9501	.375 [9.53]	
9502	.500 [12.70]	-.030 [-0.76]
9503	.625 [15.88]	
9504	.750 [19.05]	
9505	1.000 [25.40]	

KEYSTONE ELECTRONICS CORP.

ASTORIA, N.Y. 11105-2017

PART NAME

4-40 FLAT HEAD SCREW

MATERIAL

STEEL

FINISH

ZINC PLATE

DRN BY

BOONE

DATE

3.1.04

APPD

LN

SCALE

5X

TOLERANCES

INCH [MM]

DECIMAL $\pm .015$ [± 0.38]

ANGULAR $\pm 1^\circ$

UNLESS OTHERWISE SPECIFIED

CODE

C/M

DWG NO.

9500-9505

DATE

DESCRIPTION

REV.

Mouser Electronics

Authorized Distributor

Click to View Pricing, Inventory, Delivery & Lifecycle Information:

[Keystone Electronics:](#)

[9501](#)