



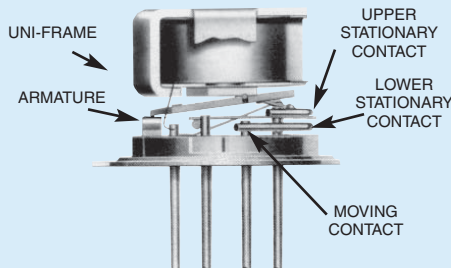
A Unit of Teledyne Electronics and Communications

## HIGH-TEMPERATURE (200°C), HIGH-PERFORMANCE TO-5 RELAY DPDT

**SERIES  
412H  
422H  
432H**

SERIES DESIGNATION	RELAY TYPE
412H	DPDT high-temperature relay
422H	DPDT high-temperature magnetic-latching relay
432H	DPDT sensitive high-temperature relay

### INTERNAL CONSTRUCTION



### DESCRIPTION

The TO-5 relay, originally conceived and developed by Teledyne, has become one of the industry standards for low-level switching from dry circuit to 1 ampere. Designed for high-density PC board mounting, these TO-5 relays are some of the most versatile ultraminiature relays available because of their small size and low coil power dissipation.

The H Series high-temperature TO-5 relays are designed for reliable operation in elevated ambient temperatures up to 200°C. Special material selection and processing provide assurance of freedom from contact contamination and mechanical malfunctioning that might otherwise be caused by ultra high ambient temperature conditions.

#### Typical applications:

- Oil exploration (down hole) instrumentation
- High temperature industrial and process control instrumentation

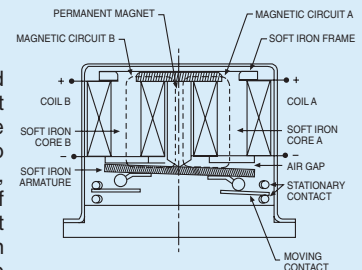
By virtue of its inherently low intercontact capacitance and contact circuit losses, the H Series relays have proven to be excellent ultraminiature RF switches for applications with frequency ranges well into the UHF spectrum (see Figures 1 and 2).

412H 432H		ENVIRONMENTAL AND PHYSICAL SPECIFICATIONS
Temperature (Ambient)		-65°C to +200°C
Vibration (General Note 1)		30 g's to 3000 Hz
Shock (General Note 1)		75 g's, 6 msec, half-sine
Acceleration		50 g's
Enclosure		Hermetically sealed
Weight	412H	0.09 oz. (2.55g) max.
	432H	0.15 oz. (4.25g) max.

422H		ENVIRONMENTAL AND PHYSICAL SPECIFICATIONS
Temperature (Ambient)		-65°C to +200°C
Vibration (General Note 1)		30 g's to 3000 Hz
Shock (General Note 1)		100 g's, 6 msec, half-sine
Acceleration		50 g's
Enclosure		Hermetically sealed
Weight		0.10 oz. (2.84g) max.

### PRINCIPLE OF OPERATION 422H

Energizing Coil B produces a magnetic field opposing the holding flux of the permanent magnet in Circuit B. As this net holding force decreases, the attractive force in the air gap of circuit A, which also results from the flux of the permanent magnet, becomes great enough to break the armature free of Core B, and snap it into a closed position against Core A. The armature then remains in this position upon removal of power from Coil B, but will snap back to position B upon energizing Coil A. Since operation depends upon cancellation of a magnetic field, it is necessary to apply the correct polarity to the relay coils as indicated on the relay schematic.



When latching relays are installed in equipment, the latch and reset coils should not be pulsed simultaneously. Coils should not be pulsed with less than rated coil voltage and the pulse width should be a minimum of three times the specified operate time of the relay. If these conditions are not followed, it is possible for the relay to be in the magnetically neutral position.

HIGH-PERFORMANCE

**SERIES 412H/422H/432H**

**GENERAL ELECTRICAL SPECIFICATIONS (-65°C to +200°C unless otherwise noted) (Notes 2 & 3)**

<b>Contact Arrangement</b>	2 Form C (DPDT)		
<b>Rated Duty</b>	Continuous		
<b>Contact Resistance</b>	412H/432H: 0.125 ohms max. before life; 0.225 ohms max. after life at 1A/28Vdc 422H: 0.15 ohms max. before life; .25 ohms max after life at 1A/28Vdc } measured 1/8" below header		
<b>Contact Load Ratings (DC)</b> (See Fig. 3 for other DC resistive voltage/current ratings)	Resistive:	1 Amp/28Vdc	
	Inductive:	200 mA/28Vdc (320 mH)	
	Lamp:	100 mA/28Vdc	
	Low Level:	10 to 50µA/10 to 50mV	
<b>Contact Load Ratings (AC)</b> (Note 4)	Resistive:	250 mA/115Vac, 60 and 400 Hz (Case not grounded) 100 mA/115Vac, 60 and 400 Hz (Case grounded)	
<b>Contact Life Ratings</b> (Note 4)	10,000,000 cycles (typical) at low level 1,000,000 cycles (typical) at 0.5A/28Vdc resistive 100,000 cycles min. at all other loads specified above		
<b>Contact Overload Rating</b>	2A/28Vdc Resistive (100 cycles min.)		
<b>Contact Carry Rating</b>	Contact factory		
<b>Coil Operating Power</b>	412H: 450 mW typ. @ 25°C	422H: 290 mW typ. @ 25°C	432H 200 mW typ. @ 25°C
<b>Operate Time</b>	412H: 2.0 msec max.	422H: 1.5 msec max.	432H: 4.0 msec max
<b>Release Time</b>	2.0 msec max.		
<b>Contact Bounce</b>	1.5 msec max.		
<b>Intercontact Capacitance</b>	0.4 pf typical		
<b>Insulation Resistance</b>	10,000 megohms min. between mutually isolated terminals		
<b>Dielectric Strength</b>	Atmospheric pressure: 500 Vrms/60Hz	70,000 ft.: 125 Vrms/60Hz	
<b>Minimum Operate Pulse</b>	4.5 msec width @ rated voltage (422H only)		

**412H SERIES RELAY**

**DETAILED ELECTRICAL SPECIFICATIONS (-65°C to +200°C unless otherwise noted) (Note 2)**

BASE PART NUMBERS →		412H-5	412H-6	412H-9	412H-12	412H-18	412H-26
<b>Coil Voltage (Vdc)</b>	Nom.	5.0	6.0	9.0	12.0	18.0	26.5
	Max.	5.8	8.0	12.0	16.0	24.0	32.0
<b>Coil Resistance (Ohms ±10% @25°C)</b>		50	98	220	390	880	1560
<b>Pick-up Voltage (Vdc, Max.)</b>		4.7	5.9	9.0	11.9	17.8	24.0
<b>Drop-out Voltage (Vdc)</b>	Min.	0.14	0.18	0.35	0.41	0.59	0.89
	Max.	2.4	3.4	5.1	6.8	10.2	13.5

**422H SERIES RELAY**

**DETAILED ELECTRICAL SPECIFICATIONS (-65°C to +200°C unless otherwise noted) (Note 2)**

BASE PART NUMBERS →		422H-5	422H-6	422H-9	422H-12	422H-18	422H-26
<b>Coil Voltage (Vdc)</b>	Nom.	5.0	6.0	9.0	12.0	18.0	26.5
	Max.	5.8	8.0	12.0	16.0	24.0	32.0
<b>Coil Resistance (Ohms ±10% @25°C)</b>		61	120	280	500	1130	2000
<b>Set &amp; Reset Voltage (Vdc, Max.)</b>		4.7	5.9	9.0	11.9	17.8	24.0

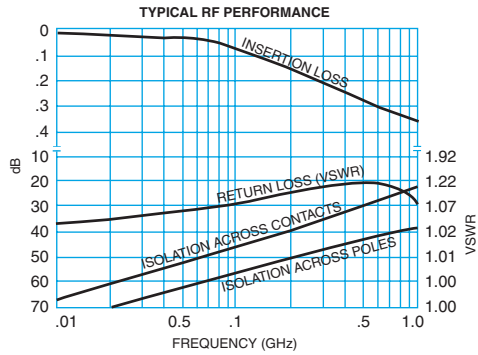
**432H SERIES RELAY**

**DETAILED ELECTRICAL SPECIFICATIONS (-65°C to +200°C unless otherwise noted) (Note 2)**

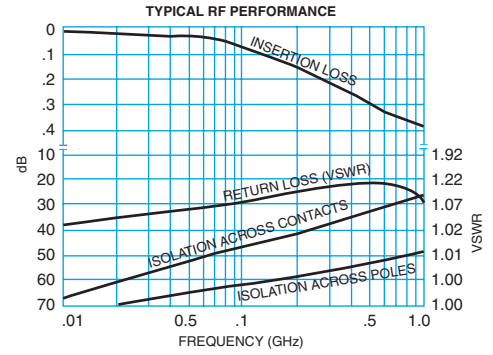
BASE PART NUMBERS →		432H-5	432H-6	432H-9	432H-12	432H-18	432H-26
<b>Coil Voltage (Vdc)</b>	Nom.	5.0	6.0	9.0	12.0	18.0	26.5
	Max.	5.8	8.0	12.0	16.0	24.0	32.0
<b>Coil Resistance (Ohms ±10% @25°C)</b>		100	200	400	850	1600	3300
<b>Pick-up Voltage (Vdc, Max.)</b>		4.7	5.9	9.0	11.9	17.8	24.0
<b>Drop-out Voltage (Vdc)</b>	Min.	0.14	0.18	0.35	0.41	0.59	0.89
	Max.	2.4	3.4	5.1	6.8	10.2	13.5

HIGH-PERFORMANCE

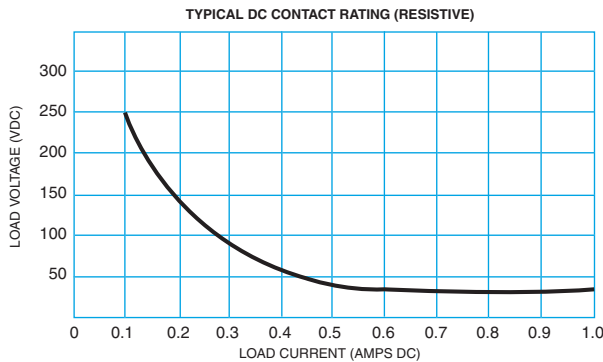
**PERFORMANCE CURVES**  
(NOTE 2)



**FIGURE 1 (412H AND 432H)**

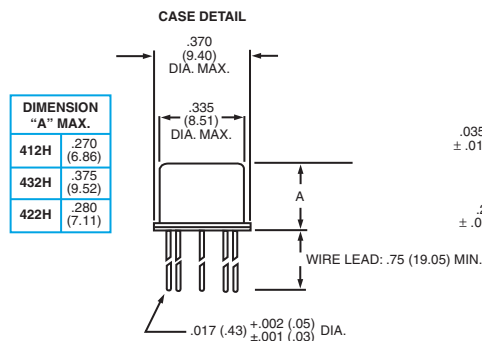


**FIGURE 2 (422H)**

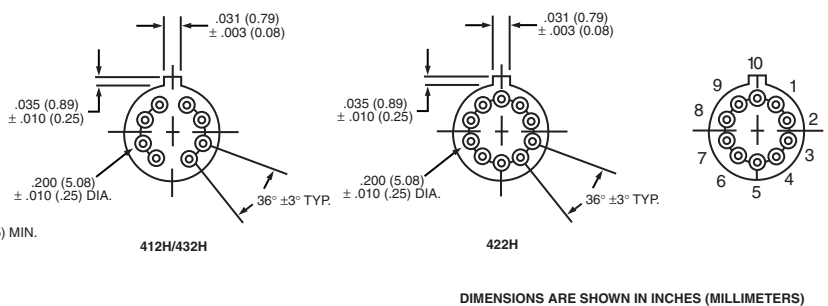


**FIGURE 3**

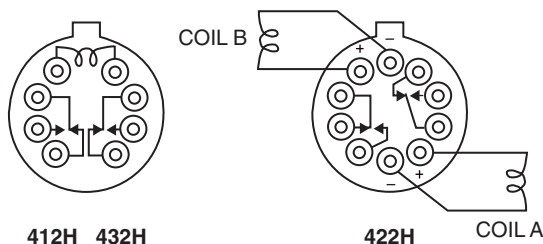
**OUTLINE DIMENSIONS**



**TERMINAL LOCATIONS AND PIN NUMBERS (REF. ONLY)**  
(Viewed from Terminals)



**SCHEMATIC DIAGRAMS**



**412H 432H**

**422H**

CONTACTS SHOWN IN POSITION RESULTING WHEN COIL A LAST ENERGIZED.

SCHEMATICS ARE VIEWED FROM TERMINALS

**GENERAL NOTES**

1. Relay contacts will exhibit no chatter in excess of 10  $\mu$ sec or transfer in excess of 1  $\mu$ sec.
2. "Typical" characteristics are based on available data and are best estimates. No on-going verification tests are performed.
3. Characteristics are subject to change after life.
4. Contact load ratings and contact life ratings are based on similarity testing at 125°C. No 200°C testing is performed.

# Appendix A: Spacer Pads

Pad designation and bottom view dimensions	Height	For use with the following:	Dim. H Max.
 <p style="text-align: center;">“M4” Pad for TO-5</p>		ER411T ER412, ER412D, ER412DD	.295 (7.49)
		712, 712D, 712TN, RF300, RF310, RF320	.300 (7.62)
		ER420, ER422D, ER420DD, 421, ER421D, ER421DD, ER422, ER422D, ER422DD, 722, 722D, RF341	.305 (7.75)
		ER431T, ER432T, ER432, ER432D, ER432DD	.400 (10.16)
		732, 732D, 732TN, RF303, RF313, RF323	.410 (10.41)
		RF312	.350 (8.89)
 <p style="text-align: center;">“M4” Pad for TO-5</p>		ER411, ER411D, ER411DD	.295 (7.49)
		ER431, ER431D, ER431DD	.400 (10.16)
		RF311	.300 (7.62)
		RF331	.410 (10.41)
 <p style="text-align: center;">“M4” Pad for Centigrid®</p>		172, 172D	.305 (7.75)
		ER114, ER114D, ER114DD, J114, J114D, J114DD	.300 (7.62)
		ER134, ER134D, ER134DD, J134, J134D, J134DD	.400 (10.16)
		RF100	.315 (8.00)
		RF103	.420 (10.67)
 <p style="text-align: center;">“M9” Pad for Centigrid®</p>		122C, A152	.320 (8.13)
		ER116C, J116C	.300 (7.62)
		ER136C, J136C	.400 (10.16)
		RF180	.325 (8.25)
		A150	.305 (7.75)

**Notes:**

1. Spacer pad material: Polyester film.
2. To specify an “M4” or “M9” spacer pad, refer to the mounting variants portion of the part numbering example in the applicable datasheet.
3. Dimensions are in inches (mm).
4. Unless otherwise specified, tolerance is  $\pm .010$  (.25).
5. Add 10 mΩ to the contact resistance show in the datasheet.
6. Add 0.01 oz. (0.25 g) to the weight of the relay assembly shown in the datasheet.

# Appendix A: Spreader Pads

Pad designation and bottom view dimensions	Height	For use with the following:	Dim. H Max.
 <p>“M” Pad <u>5/</u> <u>6/</u></p>		ER411T, J411T, ER412, ER412D ER412DD, J412, J412D, J412DD ER412T, J412T	.388 (9.86)
		712, 712D, 712TN	.393 (9.99)
		ER431T, J431T, ER432, ER432D ER432DD, J432, J432D, J432DD ER432T, J432T	.493 (12.52)
		732, 732D, 732TN	.503 (12.78)
		ER420, J420, ER420D, J420D ER420DD, J420DD, ER421, J421 ER421D, J421D, ER421DD J422D, ER422DD, J422DD, 722	.398 (10.11)
 <p>“M2” Pad <u>7/</u> <u>8/</u></p>		ER411T ER412, ER412D, ER412DD J412, J412D, J412DD	.441 (11.20)
		712, 712D	.451 (11.46)
		ER421, ER421D, ER421DD 722, 732D	.451 (11.46)
		ER431T ER432, ER432D, ER432DD	.546 (13.87)
		732, 732D	.556 (14.12)
 <p>“M3” Pad <u>5/</u> <u>6/</u> <u>9/</u></p>		ER411, ER411D, ER411DD ER411TX ER412X, ER412DX, ER412DDX ER412TX	.388 (9.86)
		712X, 712DX, 712TNX	.393 (9.99)
		ER420X, ER420DX, ER420DDX ER421X, ER421DX, ER421DDX ER422X, ER422DX ER422DDX, 722X, 722DDX	.398 (10.11)
		ER431, ER431D, ER431DD ER431TX ER432X, ER432DX, ER432DDX ER432TX	.493 (12.52)
		732X, 732DX, 732TNX	.503 (12.78)

## Notes:

1. Spreader pad material: Diallyl Phthalate.
2. To specify an “M”, “M2” or “M3” spreader pad, refer to the mounting variants portion of the part number example in the applicable datasheet.
3. Dimensions are in inches (mm).
4. Unless otherwise specified, tolerance is  $\pm .010$ ” (0.25).
- 5/. Add 25 m $\Omega$  to the contact resistance shown in the datasheet.
- 6/. Add .01 oz. (0.25 g) to the weight of the relay assembly shown in the datasheet.
- 7/. Add 50 m $\Omega$  to the contact resistance shown in the datasheet.
- 8/. Add 0.025 oz (0.71 g) to the weight of the relay assembly shown in the datasheet.
- 9/. M3 pad to be used only when the relay has a center pin (e.g. ER411M3-12A, 722XM3-26.)

# Appendix A: Ground Pin Positions



### TO-5 Relays:

ER411T, ER412, ER412T, ER420, ER421, ER422,  
ER431T, ER432, ER432T, 712, 712TN, 400H, 400K,  
400V, RF300, RF303, RF341, RF312, RF310, RF313,  
RF320, RF323



### TO-5 Relays:

ER411, ER431, RF311, RF331



### Centigrid® Relays:

RF180, ER116C, 122C, ER136C



### Centigrid® Relays:

RF100, RF103, ER114, ER134, 172

- Indicates ground pin position
- Indicates glass insulated lead position
- ◎ Indicates ground pin or lead position depending on relay type

### NOTES

1. Terminal views shown
2. Dimensions are in inches (mm)
3. Tolerances:  $\pm .010$  ( $\pm .25$ ) unless otherwise specified
4. Ground pin positions are within  $.015$  ( $0.38$ ) dia. of true position
5. Ground pin head dia.,  $0.035$  ( $0.89$ ) ref: height  $0.010$  ( $0.25$ ) ref.
6. Lead dia.  $0.017$  ( $0.43$ ) nom.

# Mouser Electronics

Authorized Distributor

Click to View Pricing, Inventory, Delivery & Lifecycle Information:

## Teledyne Relays:

[412H-12](#) [412H-26](#) [412H-5](#) [432H](#) [422H](#)