



SMT power inductors

Size 12.5 x 12.5 x 8.5 mm

Series/Type: B82477R4

Ordering code:

Date: April 2015

© EPCOS AG 2015. Reproduction, publication and dissemination of this publication, enclosures hereto and the information contained therein without EPCOS' prior express consent is prohibited.

EPCOS AG is a TDK Group Company.

SMT power inductors

Size 12.5 x 12.5 x 8.5 mm

B82477R4

Rated inductance 0.82 ...1000 μ H



Construction

- Ferrite core
- Magnetically shielded
- Winding: enamel copper wire
- Winding soldered to terminals
- Injection moulded base

Features

- High mechanical stability
- Temperature range up to +150 °C
- High rated current
- Increased current handling capability compared to B82477P4 series ($I_{sat} +30\%$)
- Qualified to AEC-Q200
- Suitable for lead-free reflow soldering as referenced in JEDEC J-STD 020D
- RoHS-compatible
- Halogen Free in the meaning of $Cl \leq 900\text{ppm}$, $Br \leq 900\text{ppm}$, $Cl+Br \leq 1500\text{ppm}$

Applications

- Filtering of supply voltages
- Coupling, decoupling
- DC/DC converters
- Automotive electronics

Terminals

- Base material
Cu ($L \leq 10\ \mu\text{H}$), CuSn6P ($L > 15\ \mu\text{H}$)
- Layer composition Ni, Sn (lead-free)
- Electro-plated

Marking

- Marking on component:
Manufacturer, L value (μH , coded),
manufacturing date (YWWDD)
- Minimum data on reel:
Manufacturer, ordering code, L value,
quantity, date of packing

Delivery mode and packing unit

- 24-mm blister tape, wound on 330-mm reel
- Packing unit: 350 pcs./reel

Dimensional drawing and layout recommendation

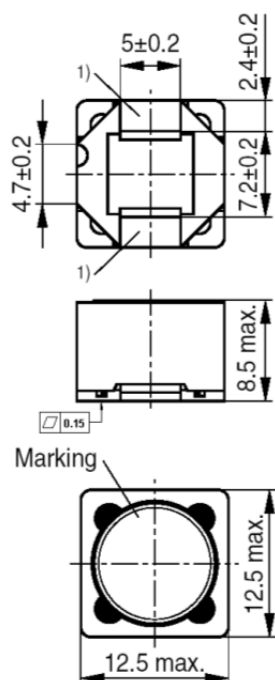

1) Soldering area

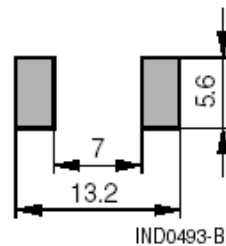

Dimensions in mm

Taping and packing

Blister tape

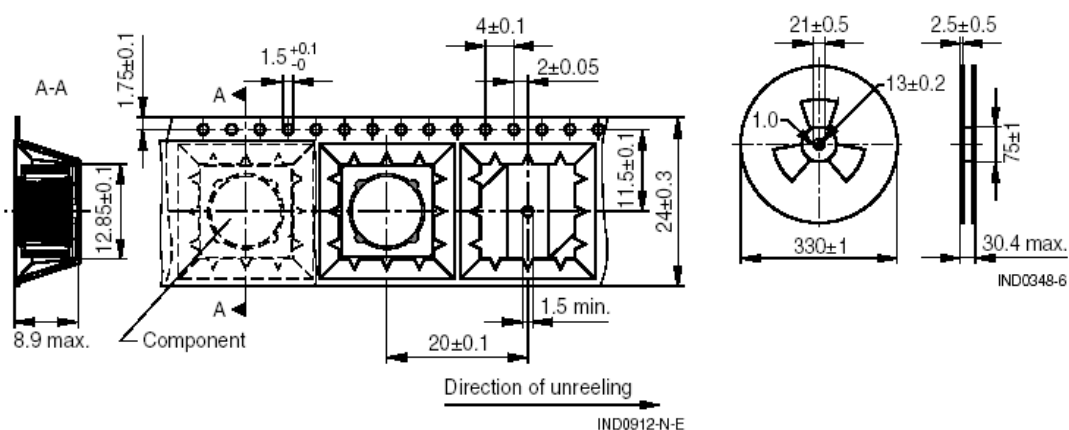

Dimensions in mm

SMT power inductors
Size 12.5 x 12.5 x 8.5 mm
B82477R4
Technical data and measuring conditions

Rated inductance L_R	Measured with LCR meter Agilent 4284A at frequency f_L , 0.1 V. +20 °C
Operating temperature range	-55 °C ... +150 °C
Rated current I_R	Max. permissible DC with temperature increase of ≤ 40 K measured at +20 °C
Saturation current I_{Sat}	Max. permissible DC current with inductance decrease $\Delta L/L_0$ of approx. 10%
DC resistance R	Measured at +20 °C
Solderability (lead-free)	Dip and look method Sn95.5Ag3.8Cu0.7: +(245 ±5) °C, (5 ±0.3) s Wetting of soldering area $\geq 90\%$ (based on IEC 60068-2-58)
Resistance to soldering heat	+260 °C, 40 s (as referenced in JEDEC J-STD 020D)
Climatic category	55/150/56 (to IEC 60068-1)
Storage conditions	Mounted: -55 °C ... +150 °C Packaged: -25 °C ... +40 °C, $\leq 75\%$ RH
Weight	Approx. 4 g

SMT power inductors
Size 12.5 x 12.5 x 8.5 mm
B82477R4
Characteristics and ordering codes

L_R μH	Tolerance	f_L MHz	I_R A	$I_{\text{sat, min}}$ A	$I_{\text{sat, typ}}$ A	R_{max} m Ω	R_{typ} m Ω	Ordering code
0.82	20% = M	0.1	12.25	27.0	38.0	5.5	3.8	B82477R4821M100
1.50			10.25	20.0	27.0	6.5	4.8	B82477R4152M100
2.00			9.50	18.0	24.0	8.0	5.9	B82477R4202M100
3.00			8.70	15.5	18.0	9.0	6.8	B82477R4302M100
3.60			8.50	13.0	16.0	10.0	7.9	B82477R4362M100
4.70			7.85	12.2	14.25	11.0	8.9	B82477R4472M100
5.60			7.60	11.0	12.75	11.5	9.9	B82477R4562M100
6.80			6.95	10.5	12.0	15.0	11.0	B82477R4682M100
10			6.20	8.75	10.25	18.5	16.4	B82477R4103M100
15			5.00	7.25	8.75	25.0	22.8	B82477R4153M100
22			4.45	6.10	7.25	32.0	28.1	B82477R4223M100
33			3.55	5.20	6.00	50.0	46.3	B82477R4333M100
47			3.35	4.30	4.90	60.0	55.7	B82477R4473M100
68			2.80	3.55	3.90	85.0	80.1	B82477R4683M100
100			2.35	2.90	3.25	120	112	B82477R4104M100
150			1.90	2.40	2.80	175	158	B82477R4154M100
220			1.45	2.00	2.20	290	275	B82477R4224M100
330			1.18	1.70	1.80	425	405	B82477R4334M100
470			1.07	1.35	1.50	605	578	B82477R4474M100
680			0.88	1.10	1.25	860	830	B82477R4684M100
1000	0.72	0.95	1.05	1350	1250	B82477R4105M100		

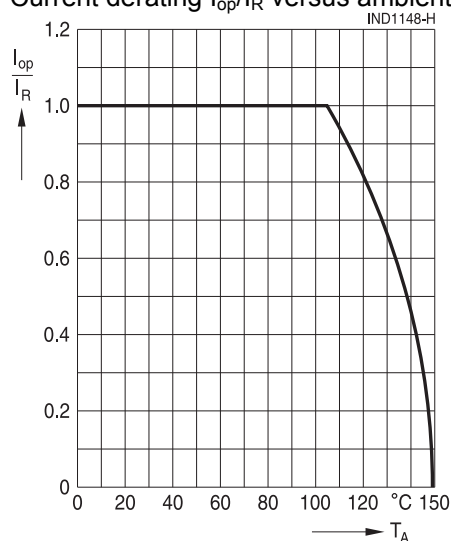
Current derating I_{op}/I_R versus ambient temperature T_A

Typical curves:

Inductance vs. DC superposition measured with LCR meter Agilent 4284A at $T_a = +20\text{ }^\circ\text{C}$

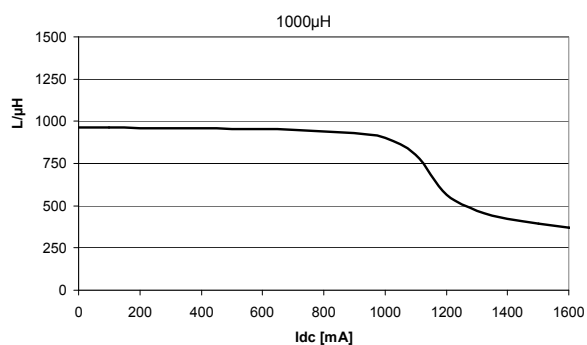
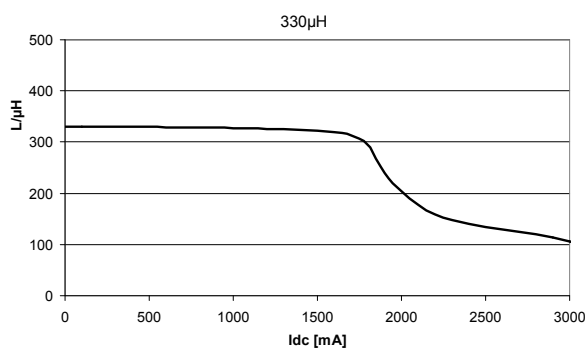
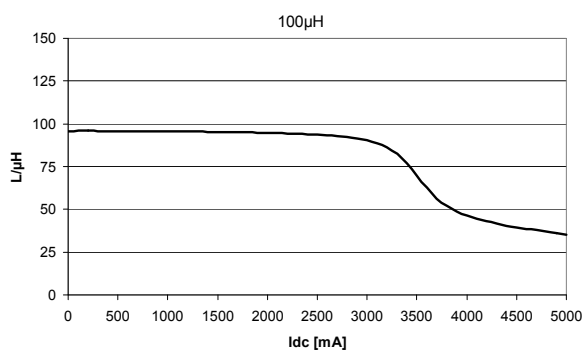
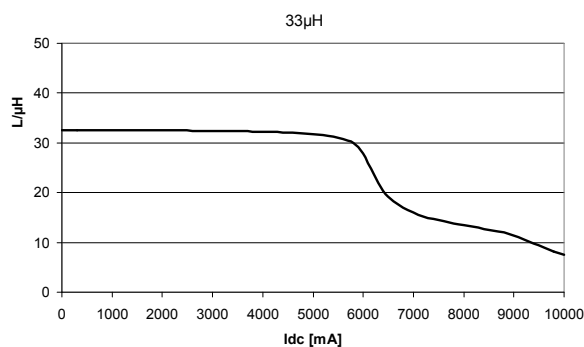
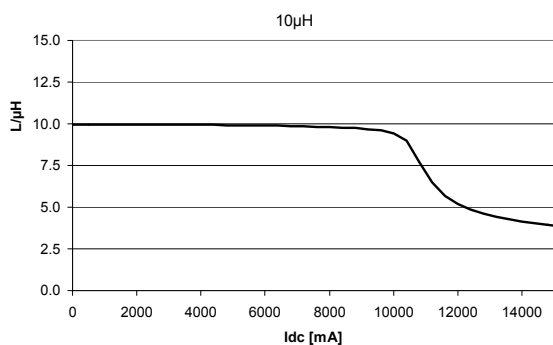
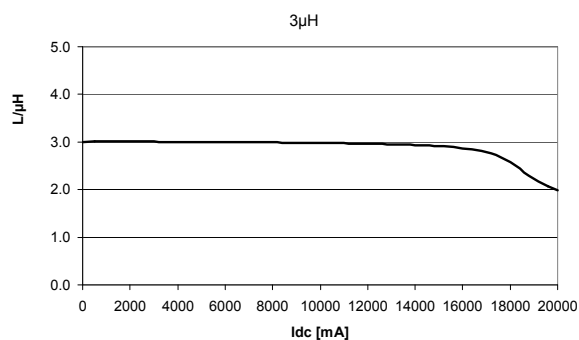
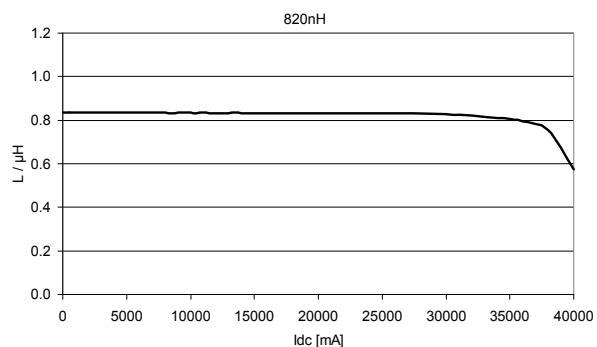

Cautions and warnings

- Please note the recommendations in our Inductors data book (latest edition) and in the data sheets.
 - Particular attention should be paid to the derating curves given there.
 - The soldering conditions should also be observed. Temperatures quoted in relation to wave soldering refer to the pin, not the housing.
- If the components are to be washed varnished it is necessary to check whether the washing varnish agent that is used has a negative effect on the wire insulation, any plastics that are used, or on glued joints. In particular, it is possible for washing varnish agent residues to have a negative effect in the long-term on wire insulation. Washing processes may damage the product due to the possible static or cyclic mechanical loads (e.g. ultrasonic cleaning). They may cause cracks to develop on the product and its parts, which might lead to reduced reliability or lifetime.
- The following points must be observed if the components are potted in customer applications:
 - Many potting materials shrink as they harden. They therefore exert a pressure on the plastic housing or core. This pressure can have a deleterious effect on electrical properties, and in extreme cases can damage the core or plastic housing mechanically.
 - It is necessary to check whether the potting material used attacks or destroys the wire insulation, plastics or glue.
 - The effect of the potting material can change the high-frequency behaviour of the components.
- Ferrites are sensitive to direct impact. This can cause the core material to flake, or lead to breakage of the core.
- Even for customer-specific products, conclusive validation of the component in the circuit can only be carried out by the customer.

Display of ordering codes for EPCOS products

The ordering code for one and the same EPCOS product can be represented differently in data sheets, data books, other publications, on the EPCOS website, or in order-related documents such as shipping notes, order confirmations and product labels. **The varying representations of the ordering codes are due to different processes employed and do not affect the specifications of the respective products.** Detailed information can be found on the Internet under www.epcos.com/orderingcodes

Important notes

The following applies to all products named in this publication:

1. Some parts of this publication contain **statements about the suitability of our products for certain areas of application**. These statements are based on our knowledge of typical requirements that are often placed on our products in the areas of application concerned. We nevertheless expressly point out **that such statements cannot be regarded as binding statements about the suitability of our products for a particular customer application**. As a rule, EPCOS is either unfamiliar with individual customer applications or less familiar with them than the customers themselves. For these reasons, it is always ultimately incumbent on the customer to check and decide whether an EPCOS product with the properties described in the product specification is suitable for use in a particular customer application.
2. We also point out that **in individual cases, a malfunction of electronic components or failure before the end of their usual service life cannot be completely ruled out in the current state of the art, even if they are operated as specified**. In customer applications requiring a very high level of operational safety and especially in customer applications in which the malfunction or failure of an electronic component could endanger human life or health (e.g. in accident prevention or life-saving systems), it must therefore be ensured by means of suitable design of the customer application or other action taken by the customer (e.g. installation of protective circuitry or redundancy) that no injury or damage is sustained by third parties in the event of malfunction or failure of an electronic component.
3. **The warnings, cautions and product-specific notes must be observed.**
4. In order to satisfy certain technical requirements, **some of the products described in this publication may contain substances subject to restrictions in certain jurisdictions (e.g. because they are classed as hazardous)**. Useful information on this will be found in our Material Data Sheets on the Internet (www.epcos.com/material). Should you have any more detailed questions, please contact our sales offices.
5. We constantly strive to improve our products. Consequently, **the products described in this publication may change from time to time**. The same is true of the corresponding product specifications. Please check therefore to what extent product descriptions and specifications contained in this publication are still applicable before or when you place an order. We also **reserve the right to discontinue production and delivery of products**. Consequently, we cannot guarantee that all products named in this publication will always be available. The aforementioned does not apply in the case of individual agreements deviating from the foregoing for customer-specific products.
6. Unless otherwise agreed in individual contracts, **all orders are subject to the current version of the "General Terms of Delivery for Products and Services in the Electrical Industry" published by the German Electrical and Electronics Industry Association (ZVEI)**.
7. The trade names EPCOS, Alu-X, CeraDiode, CeraLink, CeraPad, CeraPlas, CSMP, CSSP, CTVS, DeltaCap, DigiSiMic, DSSP, ExoCore, FilterCap, FormFit, LeaXield, MiniBlue, MiniCell, MKD, MKK, MotorCap, PCC, PhaseCap, PhaseCube, PhaseMod, PhiCap, PQSine, SIFERRIT, SIFI, SIKOREL, SilverCap, SIMDAD, SiMic, SIMID, SineFormer, SIOV, SIP5D, SIP5K, TFAP, ThermoFuse, WindCap are **trademarks registered or pending** in Europe and in other countries. Further information will be found on the Internet at www.epcos.com/trademarks.

Mouser Electronics

Authorized Distributor

Click to View Pricing, Inventory, Delivery & Lifecycle Information:

EPCOS / TDK:

[B82477R4103M100](#) [B82477R4104M100](#) [B82477R4474M100](#) [B82477R4821M100](#) [B82477R4105M100](#)
[B82477R4682M100](#) [B82477R4154M100](#) [B82477R4362M100](#) [B82477R4333M100](#) [B82477R4334M100](#)
[B82477R4202M100](#) [B82477R4473M100](#) [B82477R4684M100](#) [B82477R4223M100](#) [B82477R4562M100](#)
[B82477R4472M100](#) [B82477R4683M100](#) [B82477R4224M100](#) [B82477R4152M100](#) [B82477R4302M100](#)
[B82477R4153M100](#)