

OMRON's IC Connectors Have Excellent Reliability and Can Tolerate Momentary Interruptions in Power. Ideal for High-speed Data Processing.

- Round pins and 4-point (4-finger) contact construction ensure long life and excellent shock and vibration durability.
- Contact entry holes are large for easy insertion.
- IC lead contacts placed high for solid connections.
- No flux rise.
- A wide product range: open-frame, closed-frame, single-row, carrier-type DIP terminals, wrap terminals, solder-sleeve terminals, and low-profile DIP terminals.
- A new tin-plated product series offers more choice when it comes to selecting the optimum IC Socket for an application.
- Conform to UL standards (file no. E 103202)(Excluding XR2P).

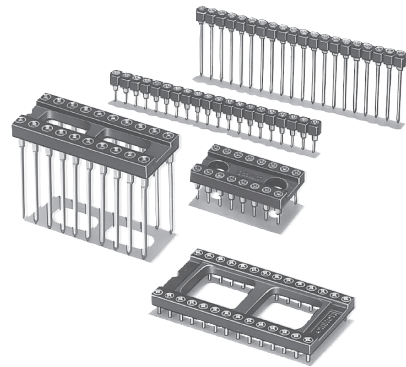

* Excluding XR2P

RoHS Compliant

■ Construction

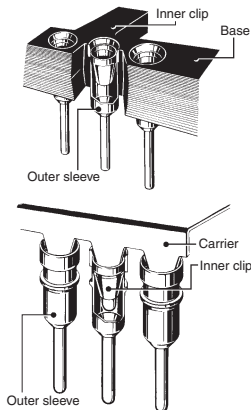

■ Contact Dimensions

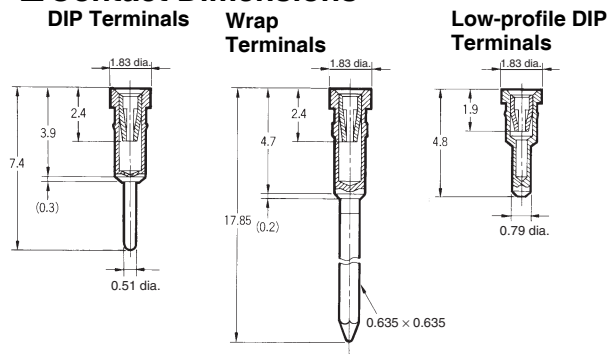

■ Ratings and Characteristics

Item	Gold plated	Gold flash plated
Rated current	1 A	
Rated voltage	300 VAC	
Contact resistance	20 mΩ max. (at 20 mV, 100 mA max.)	
Insulation resistance	1,000 MΩ min. (at 500 VDC)	
Dielectric strength	1,000 VAC for 1 min (leakage current: 1 mA max.)	
Insertion force (See note.)	3.92 N max.	
Removal force (See note.)	0.64 N min.	
Insertion durability	100 times (0.75-μm gold plating), 50 times (0.25-μm gold plating)	20 times (gold flash plating)
Ambient operating temperature	- 55 to 125°C (with no condensation or icing)	

Note: The contact insertion force and contact removal force are for a test gauge, t = 0.432 mm.

■ Materials and Finish

Base	PBT resin (UL94 V-0)/black
Inner clip (See Note.)	Beryllium copper/nickel base, gold plated
	Beryllium copper/nickel base, gold flash plating
Outer sleeve (See Note.)	Brass/nickel base, gold flash plating

Note: For non-standard plating, contact your OMRON representative.

■ Applicable Wrap Post Wire Sizes

AWG30, AWG28, AWG26, AWG24
(Solid wire: 0.25 to 0.51 mm dia.)

■ Wrap Post Length

3 wires

■ Applicable IC Lead Dimensions

DIP, and Wrap Terminals

	Depth × width (mm)	
Flat lead	0.29 ±0.09 × 0.46 ±0.08 (See note 1.)	
Round lead	0.53 dia. max.	0.41 dia. min.

Low-profile DIP Terminals

	Depth × width (mm)	
Flat lead	0.29 ±0.09 × 0.46 ±0.08 (See note 2.)	
Round lead	0.50 dia. max.	0.41 dia. min.

- Note:**
1. Do not use wire where the diagonal is more than 0.56 mm.
 2. Do not use wire where the diagonal is more than 0.52 mm.
 3. IC lead length of 3 mm or more (If the lead terminal is too long, the IC may rise up.)

XR2A Open-frame Sockets

■ Dimensions

(unit: mm)

XR2A-□□11-N
 XR2A-2463-N
 XR2A-2473-N
 XR2A-□□01-N
 XR2A-2461-N
 XR2A-2471-N
 XR2A-□□21-N
 XR2A-2467-N
 XR2A-2477-N
 (With DIP terminals)

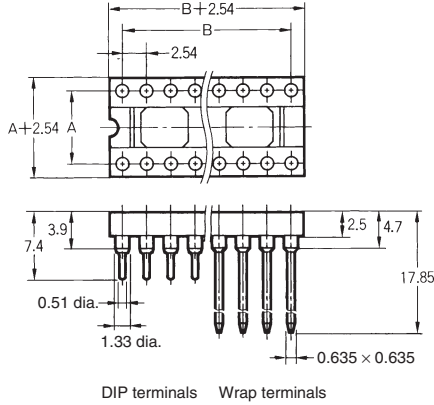
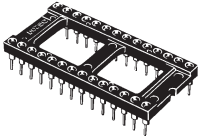

XR2A-□□02
 (With wrap terminals)

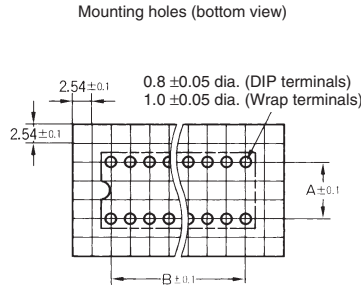
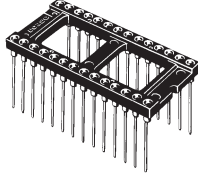

Dimensions

No. of contacts	Dimensions (mm)	
	A	B
8	7.62	7.62
14	7.62	15.24
16	7.62	17.78
18	7.62	20.32
20	7.62	22.86
22	10.16	25.40
24 (See note 1.)	15.24	27.94
24 (See note 2.)	10.16	27.94
24 (See note 3.)	7.62	27.94
28	15.24	33.02
32	15.24	38.10
40	15.24	48.26
42	15.24	50.80
48	15.24	58.42
50	22.86	60.96
64	22.86	78.74

- Note:**
1. XR2A-2401-N/XR2A-2402/
XR2A-2411-N/XR2A-2421-N
 2. XR2A-2461-N/XR2A-2463-N/
XR2A-2467-N
 3. XR2A-2471-N/XR2A-2473-N/
XR2A-2477-N

■ Ordering Information

Appearance		Sockets with DIP terminals			Sockets with wrap terminals
No of contacts	Row pitch (A) (mm)				
		With 0.25-μm gold plating	With 0.75-μm gold plating	With gold flash plating	With 0.75-μm gold plating
8	7.62	XR2A-0811-N	XR2A-0801-N	XR2A-0821-N	XR2A-0802
14	7.62	XR2A-1411-N	XR2A-1401-N	XR2A-1421-N	XR2A-1402
16	7.62	XR2A-1611-N	XR2A-1601-N	XR2A-1621-N	XR2A-1602
18	7.62	XR2A-1811-N	XR2A-1801-N	XR2A-1821-N	XR2A-1802
20	7.62	XR2A-2011-N	XR2A-2001-N	XR2A-2021-N	XR2A-2002
22	10.16	XR2A-2211-N	XR2A-2201-N	XR2A-2221-N	XR2A-2202
24	15.24	XR2A-2411-N	XR2A-2401-N	XR2A-2421-N	XR2A-2402
24	10.16	XR2A-2463-N	XR2A-2461-N	XR2A-2467-N	---
24	7.62	XR2A-2473-N	XR2A-2471-N	XR2A-2477-N	XR2A-2472
28	15.24	XR2A-2811-N	XR2A-2801-N	XR2A-2821-N	XR2A-2802
32	15.24	XR2A-3211-N	XR2A-3201-N	XR2A-3221-N	XR2A-3202
40	15.24	XR2A-4011-N	XR2A-4001-N	XR2A-4021-N	XR2A-4002
42	15.24	XR2A-4211-N	XR2A-4201-N	XR2A-4221-N	XR2A-4202
48	15.24	XR2A-4811-N	XR2A-4801-N	---	XR2A-4802
50	22.86	XR2A-5011-N	XR2A-5001-N	---	---
64	22.86	XR2A-6411-N	XR2A-6401-N	---	XR2A-6402

XR2A Open-frame Sockets (with Low-profile DIP Terminals)

■ Dimensions

(unit: mm)

XR2A-□□15
 XR2A-2466
 XR2A-2476
 XR2A-□□05
 XR2A-2465
 XR2A-2475
 XR2A-□□25
 XR2A-2468
 XR2A-2478

(With low-profile DIP terminals)

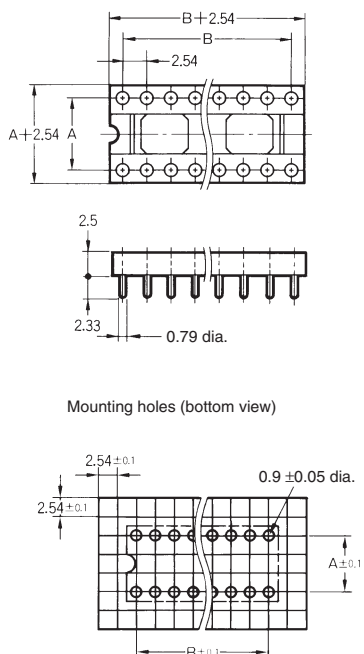
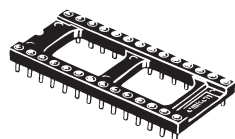

Dimensions

No. of contacts	Dimensions (mm)	
	A	B
8	7.62	7.62
14	7.62	15.24
16	7.62	17.78
18	7.62	20.32
20	7.62	22.86
22	10.16	25.40
24 (See note 1.)	15.24	27.94
24 (See note 2.)	10.16	27.94
24 (See note 3.)	7.62	27.94
28	15.24	33.02
32	15.24	38.10
40	15.24	48.26
42	15.24	50.80
48	15.24	58.42
64	22.86	78.74

- Note:**
1. XR2A-2415/XR2A-2405/XR2A-2425
 2. XR2A-2466/XR2A-2465/XR2A-2468
 3. XR2A-2476/XR2A-2475/XR2A-2478

■ Ordering Information

Appearance		Sockets with DIP terminals		
No. of contacts	Row pitch (A) (mm)			
		With 0.25- μ m gold plating	With 0.75- μ m gold plating	With gold flash plating
8	7.62	XR2A-0815	XR2A-0805	XR2A-0825
14	7.62	XR2A-1415	XR2A-1405	XR2A-1425
16	7.62	XR2A-1615	XR2A-1605	XR2A-1625
18	7.62	XR2A-1815	XR2A-1805	XR2A-1825
20	7.62	XR2A-2015	XR2A-2005	XR2A-2025
22	10.16	XR2A-2215	XR2A-2205	XR2A-2225
24	15.24	XR2A-2415	XR2A-2405	XR2A-2425
24	10.16	XR2A-2466	XR2A-2465	XR2A-2468
24	7.62	XR2A-2476	XR2A-2475	XR2A-2478
28	15.24	XR2A-2815	XR2A-2805	XR2A-2825
32	15.24	XR2A-3215	XR2A-3205	XR2A-3225
40	15.24	XR2A-4015	XR2A-4005	XR2A-4025
42	15.24	XR2A-4215	XR2A-4205	---
48	15.24	XR2A-4815	XR2A-4805	---
64	22.86	XR2A-6415	XR2A-6405	---

XR2B Closed-frame Sockets

■ Dimensions

(unit: mm)

XR2B-1611-N
XR2B-1601-N

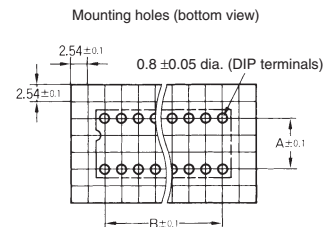
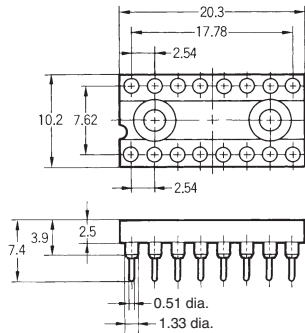
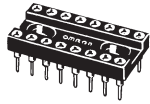

XR2B-□□11-N
XR2B-□□01-N

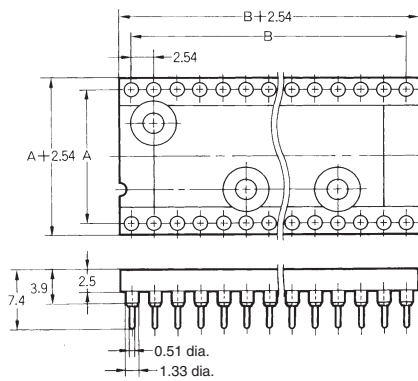
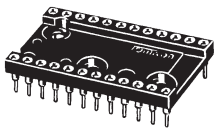

Dimensions

No. of contacts	Dimensions (mm)	
	A	B
16	7.62	17.78
24	15.24	27.94
28	15.24	33.02
32	15.24	38.10
40	15.24	48.26

■ Ordering Information

Appearance		Sockets with DIP terminals	
No. of contacts	Row pitch (A) (mm)	With 0.25-μm gold plating	With 0.75-μm gold plating
16	7.62	XR2B-1611-N	XR2B-1601-N
24	15.24	XR2B-2411-N	XR2B-2401-N
28	15.24	XR2B-2811-N	XR2B-2801-N
32	15.24	XR2B-3211-N	XR2B-3201-N
40	15.24	XR2B-4011-N	XR2B-4001-N

XR2T Open-frame Sockets with Seal Tape

- Equipped with seal tape to prevent flux cleaning liquids from entering the Socket.
- The same round-pin, 4-point contact structure as the XR2A is used for the contacts.

■ Dimensions

(unit: mm)

XR2T-□□11-N
 XR2T-2473-N
 XR2T-□□01-N
 XR2T-2471-N
 XR2T-□□21-N
 XR2T-2477-N

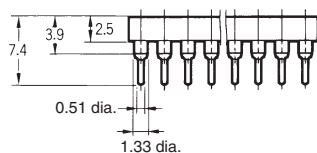
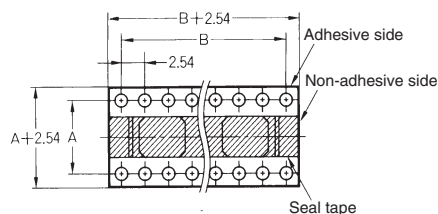
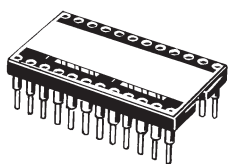

Mounting holes (bottom view)

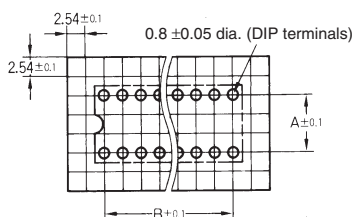

Dimensions

No. of contacts	Dimensions (mm)	
	A	B
8	7.62	7.62
14	7.62	15.24
16	7.62	17.78
18	7.62	20.32
20	7.62	22.86
22	10.16	25.40
24 (See note 1.)	15.24	27.94
24 (See note 2.)	7.62	27.94
28	15.24	33.02
32	15.24	38.10
40	15.24	48.26
48	15.24	58.42

- Note: 1.** XR2T-2411-N/XR2T-2401-N/
 XR2A-2421-N
2. XR2T-2473-N/XR2T-2471-N/
 XR2T-2477-N

■ Ordering Information

Appearance		Sockets with DIP terminals		
No. of contacts	Row pitch (A) (mm)			
		With 0.25- μ m gold plating	With 0.75- μ m gold plating	With gold flash plating
8	7.62	XR2T-0811-N	XR2T-0801-N	XR2T-0821-N
14	7.62	XR2T-1411-N	XR2T-1401-N	XR2T-1421-N
16	7.62	XR2T-1611-N	XR2T-1601-N	XR2T-1621-N
18	7.62	XR2T-1811-N	XR2T-1801-N	XR2T-1821-N
20	7.62	XR2T-2011-N	XR2T-2001-N	XR2T-2021-N
22	10.16	XR2T-2211-N	XR2T-2201-N	XR2T-2221-N
24	15.24	XR2T-2411-N	XR2T-2401-N	XR2T-2421-N
24	7.62	XR2T-2473-N	XR2T-2471-N	XR2T-2477-N
28	15.24	XR2T-2811-N	XR2T-2801-N	XR2T-2821-N
32	15.24	XR2T-3211-N	XR2T-3201-N	XR2T-3221-N
40	15.24	XR2T-4011-N	XR2T-4001-N	XR2T-4021-N
48	15.24	XR2T-4811-N	XR2T-4801-N	---

XR2C Single-row Sockets

- The contact has a round-pin 4-point contact structure, which is the same as the XR2A series.
- The single-row type allows you set the pitch between lines freely.
- Components can easily be divided into a desired number of pins.

■ Dimensions

(unit: mm)

XR2C-□□11-N
 XR2C-□□01-N
 XR2C-□□21-N
 (With DIP terminals)

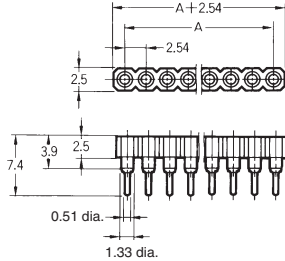
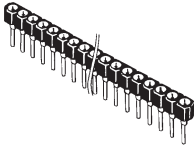

XR2C-□□15
 XR2C-□□05
 XR2C-□□25
 (With low-profile DIP terminals)

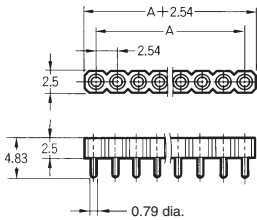
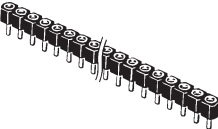

Mounting holes (bottom view)

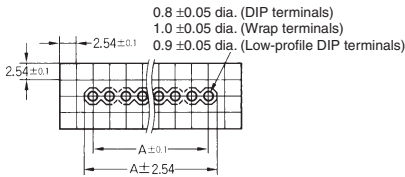

Dimensions

No. of contacts	A (mm)
20	48.26
32	78.74

XR2C-□□02
 (With wrap terminals)

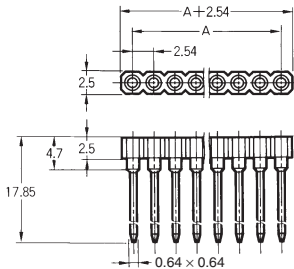
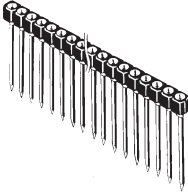

■ Ordering Information

Appearance	No. of contacts	With 0.25-μm gold plating	With 0.75-μm gold plating	With gold flash plating
Sockets with DIP terminals 	10	XR2C-1011-N	---	---
	16	XR2C-1611-N	---	---
	20	XR2C-2011-N	XR2C-2001-N	XR2C-2021-N
	32	XR2C-3211-N	XR2C-3201-N	XR2C-3221-N
Sockets with low-profile DIP terminals 	20	XR2C-2015	XR2C-2005	XR2C-2025
	32	XR2C-3215	XR2C-3205	XR2C-3225
Sockets with wrap terminals 	20	---	XR2C-2002	---
	32	---	XR2C-3202	---

XR2P Single-row Round Pin Plugs

Single-row Round Pins for Low-profile Stacking

- Single row with 2.54-mm pitch.
- Low-profile stacking possible in combination with Single-row IC Sockets (XR2C).
- Easily divided into the desired number of contacts.

RoHS Compliant

■ Ratings and Characteristics

Rated current	1 A
Rated voltage	300 VAC
Contact resistance (See note.)	20 mΩ max. (at 20 mV, 10 mA max.)
Insulation resistance	1,000 MΩ min. (at 500 VDC)
Dielectric strength	1,000 VAC for 1 min (leakage current: 1 mA max.)
Ambient operating temperature	- 55 to 125°C (with no condensation or icing)

Note: The contact and vibration resistance are the values when the Plug is mated with an XR2C.

■ Materials and Finish

Base	PCT resin (UL94 V-0)/black	
Contacts	Mating end	Brass/nickel base with gold plating
	Terminal	

■ Applicable Sockets

XR2C-□□11-N	IC Sockets (single row)
XR2C-□□□5	IC Socket (single row, low profile)

■ Dimensions

(unit: mm)

XR2P-□□41
(With DIP straight terminals)

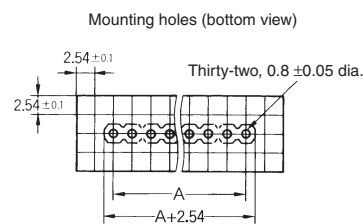
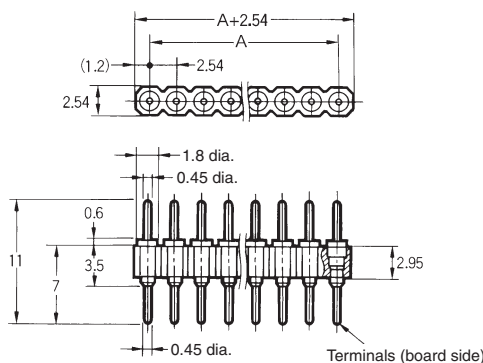
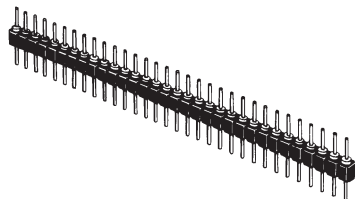

Dimensions

No. of contacts	A (mm)
10	22.86
16	38.1
20	48.26
32	78.74

Ordering Information

No. of contacts	Model
10	XR2P-1041
16	XR2P-1641
20	XR2P-2041
32	XR2P-3241

■ Mated Dimensions

XR2P-□□41 with XR2C-□□11-N
Single-row IC Socket

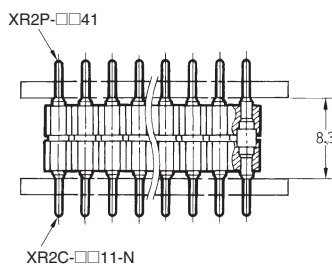

XR2P-□□41 with XR2C-□□□5
Single-row Low-profile IC Socket

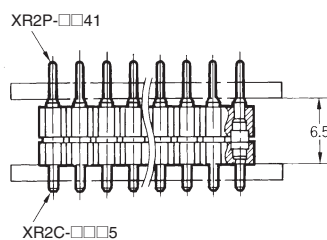

■ Tools and Accessories (Sold Separately)

(unit: mm)

XR2Z-11
IC Holder

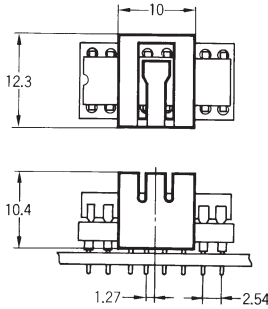

XR2Z-13

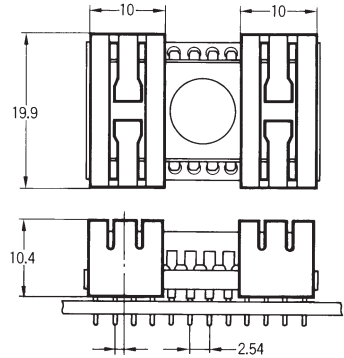

Model	No. of IC Socket contacts	IC socket width
XR2Z-11	14, 16, 18, 20, 24	7.62 mm
XR2Z-13	24, 28, 32, 40, 42, 48	15.24 mm

Note: This Holder protects the IC from falling out due to shock. The IC will not fall out even with a 980 m/s² shock. Applicable IC height: 2.7 to 5.6 mm.

XY2C-0101
XY2C-0103
IC Removal Tool

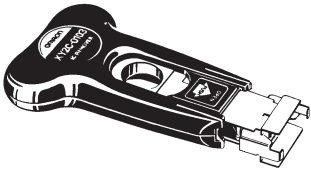

Model	No. of IC Socket contacts	IC socket width
XY2C-0101	14, 16, 18, 20	7.62 mm
XY2C-0103	24, 28, 32, 40	15.24 mm

■ Precautions

Correct Use

Soldering

- When soldering, make sure that the outer sleeve of the IC Socket does not stick out of the circuit board through-holes.

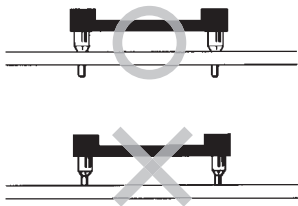

- Make sure that no flux enters the IC Socket from the top.

Removing ICs

- Use the XY2C-0101 or XY2C-0103 IC Removal Tool to remove ICs.
- Do not use a screwdriver to remove the IC. It may damage the circuit board.
- Do not use a testing rod or check pin to check contacts or circuits. This may damage the inner clips or plating and may lead to improper contact.
- Four-point contact construction is used for plated products to make them more tolerant of momentary power interruptions. We recommend using gold-plated contacts in areas subject to vibration and shock.

Automated Soldering Conditions (Jet Flow)

- Soldering temperature: 250±5°C
- Continuous soldering time: Within 5±1 s

Applicable IC Lead Dimensions

- Use leads that are within the range shown here. For details, refer to page 2. Use an IC with leads longer than 3 mm. If the leads are too long, the IC will not sit flush on the board.
- Use an IC with tapered leads for easy insertion, a minimum amount of bending, and minimum damage to the leads.

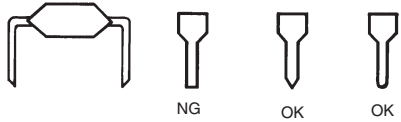

- Application examples provided in this document are for reference only. In actual applications, confirm equipment functions and safety before using the product.
- Consult your OMRON representative before using the product under conditions which are not described in the manual or applying the product to nuclear control systems, railroad systems, aviation systems, vehicles, combustion systems, medical equipment, amusement machines, safety equipment, and other systems or equipment that may have a serious influence on lives and property if used improperly. Make sure that the ratings and performance characteristics of the product provide a margin of safety for the system or equipment, and be sure to provide the system or equipment with double safety mechanisms.

Note: Do not use this document to operate the Unit.

Mouser Electronics

Authorized Distributor

Click to View Pricing, Inventory, Delivery & Lifecycle Information:

Omron:

[XR2A-0825](#) [XR2A-1425](#) [XR2A-1625](#) [XR2A-2025](#) [XR2C-2015](#) [XR2T-1621-N](#) [XR2T-2021-N](#) [XR2A-0802](#) [XR2A-1401-N](#) [XR2A-1801-N](#) [XR2A-2001-N](#) [XR2A-2401-N](#) [XR2A-2801-N](#) [XR2A-2811-N](#) [XR2A-2815](#) [XR2A-3201-N](#) [XR2A-3211-N](#) [XR2A-4001-N](#) [XR2C-1511-N](#) [XR2C-2000-HSG](#) [XR2C-2002](#) [XR2C-2005](#) [XR2C-2011-N](#) [XR2C-3200-HSG](#) [XR2C-3205](#) [XR2H-1611-N](#) [XR2P-1541](#) [XR2P-3241](#) [XR2Z-13](#) [XR2A-0811-N](#) [XR2A-1411-N](#) [XR2A-1611-N](#) [XR2A-2411-N](#) [XR2A-4011-N](#) [XR2C-1611-N](#) [XR2P-1641](#) [XR2A-3211-NZ](#) [XR2C-0311-N](#) [XR2C-1501-N](#) [XR2A-2201-N](#) [XR2C-1011-N](#) [XR2P-1041](#) [XR2P-2041](#) [XR2T-2401-N](#) [XR2T-2411-N](#) [XR2T-2421-N](#) [XR2C-2611-N](#) [XR2C-3211-N](#) [XR2C-3215](#) [XR2A-3221-N](#)