

### INSULATED GATE BIPOLAR TRANSISTOR WITH ULTRAFAST SOFT RECOVERY DIODE

#### Features

- Low  $V_{CE(ON)}$  trench IGBT technology
- Low switching losses
- Square RBSOA
- 100% of the parts tested for  $I_{LM}$  ①
- Positive  $V_{CE(ON)}$  temperature co-efficient
- Ultra fast soft recovery co-pak diode
- Tight parameter distribution
- Lead-Free

#### Benefits

- High efficiency in a wide range of applications
- Suitable for a wide range of switching frequencies due to low  $V_{CE(ON)}$  and low switching losses
- Rugged transient performance for increased reliability
- Excellent current sharing in parallel operation

#### Applications

- U.P.S.
- Welding
- Solar Inverter
- Induction Heating

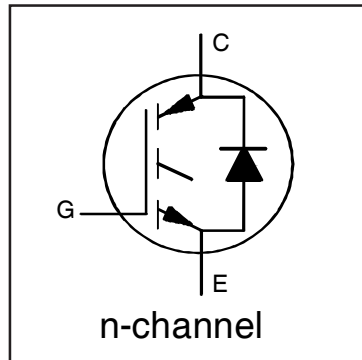

$V_{CES} = 1200V$
$I_{NOMINAL} = 40A$
$T_{J(max)} = 150^{\circ}C$
$V_{CE(on)} \text{ typ.} = 1.7V$

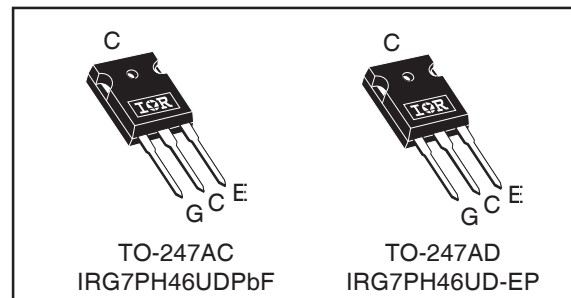

<b>G</b>	<b>C</b>	<b>E</b>
Gate	Collector	Emitter

#### Absolute Maximum Ratings

	Parameter	Max.	Units	
$V_{CES}$	Collector-to-Emitter Voltage	1200	V	
$I_C @ T_C = 25^{\circ}C$	Continuous Collector Current (Silicon Limited)	108	A	
$I_C @ T_C = 100^{\circ}C$	Continuous Collector Current (Silicon Limited)	57		
$I_{NOMINAL}$	Nominal Current	40		
$I_{CM}$	Pulse Collector Current, $V_{GE} = 20V$	160		
$I_{LM}$	Clamped Inductive Load Current, $V_{GE} = 20V$ ①	160		
$I_F @ T_C = 25^{\circ}C$	Diode Continuous Forward Current	108		
$I_F @ T_C = 100^{\circ}C$	Diode Continuous Forward Current	57		
$I_{FM}$	Diode Maximum Forward Current ②	160		
$V_{GE}$	Continuous Gate-to-Emitter Voltage	$\pm 30$		V
$P_D @ T_C = 25^{\circ}C$	Maximum Power Dissipation	390		W
$P_D @ T_C = 100^{\circ}C$	Maximum Power Dissipation	156		
$T_J$ $T_{STG}$	Operating Junction and Storage Temperature Range	-55 to +150	$^{\circ}C$	
	Soldering Temperature, for 10 sec.	300 (0.063 in. (1.6mm) from case)		
	Mounting Torque, 6-32 or M3 Screw	10 lbf-in (1.1 N·m)		

#### Thermal Resistance

	Parameter	Min.	Typ.	Max.	Units
$R_{\theta JC}$ (IGBT)	Thermal Resistance Junction-to-Case-(each IGBT) ④	—	—	0.32	$^{\circ}C/W$
$R_{\theta JC}$ (Diode)	Thermal Resistance Junction-to-Case-(each Diode) ④	—	—	0.66	
$R_{\theta CS}$	Thermal Resistance, Case-to-Sink (flat, greased surface)	—	0.24	—	
$R_{\theta JA}$	Thermal Resistance, Junction-to-Ambient (typical socket mount)	—	40	—	

**Electrical Characteristics @ T<sub>J</sub> = 25°C (unless otherwise specified)**

	Parameter	Min.	Typ.	Max.	Units	Conditions
V <sub>(BR)CES</sub>	Collector-to-Emitter Breakdown Voltage	1200	—	—	V	V <sub>GE</sub> = 0V, I <sub>C</sub> = 100μA ③
ΔV <sub>(BR)CES</sub> /ΔT <sub>J</sub>	Temperature Coeff. of Breakdown Voltage	—	1.2	—	V/°C	V <sub>GE</sub> = 0V, I <sub>C</sub> = 1.0mA (25°C-150°C)
V <sub>CE(on)</sub>	Collector-to-Emitter Saturation Voltage	—	1.7	2.0	V	I <sub>C</sub> = 40A, V <sub>GE</sub> = 15V, T <sub>J</sub> = 25°C
		—	2.0	—		I <sub>C</sub> = 40A, V <sub>GE</sub> = 15V, T <sub>J</sub> = 150°C
V <sub>GE(th)</sub>	Gate Threshold Voltage	3.0	—	6.0	V	V <sub>CE</sub> = V <sub>GE</sub> , I <sub>C</sub> = 1.6mA
ΔV <sub>GE(th)</sub> /ΔT <sub>J</sub>	Threshold Voltage temp. coefficient	—	-13	—	mV/°C	V <sub>CE</sub> = V <sub>GE</sub> , I <sub>C</sub> = 1.6mA (25°C - 150°C)
g <sub>fe</sub>	Forward Transconductance	—	50	—	S	V <sub>CE</sub> = 50V, I <sub>C</sub> = 40A, PW = 20μs
I <sub>CES</sub>	Collector-to-Emitter Leakage Current	—	1.5	100	μA	V <sub>GE</sub> = 0V, V <sub>CE</sub> = 1200V
		—	2.0	—	mA	V <sub>GE</sub> = 0V, V <sub>CE</sub> = 1200V, T <sub>J</sub> = 150°C
V <sub>FM</sub>	Diode Forward Voltage Drop	—	3.1	4.8	V	I <sub>F</sub> = 40A
		—	3.0	—		I <sub>F</sub> = 40A, T <sub>J</sub> = 150°C
I <sub>GES</sub>	Gate-to-Emitter Leakage Current	—	—	±200	nA	V <sub>GE</sub> = ±30V

**Switching Characteristics @ T<sub>J</sub> = 25°C (unless otherwise specified)**

	Parameter	Min.	Typ.	Max.	Units	Conditions
Q <sub>g</sub>	Total Gate Charge (turn-on)	—	220	320	nC	I <sub>C</sub> = 40A ② V <sub>GE</sub> = 15V V <sub>CC</sub> = 600V
Q <sub>ge</sub>	Gate-to-Emitter Charge (turn-on)	—	30	50		
Q <sub>gc</sub>	Gate-to-Collector Charge (turn-on)	—	85	130		
E <sub>on</sub>	Turn-On Switching Loss	—	2610	3515	μJ	I <sub>C</sub> = 40A, V <sub>CC</sub> = 600V, V <sub>GE</sub> = 15V ⑤ R <sub>G</sub> = 10Ω, L = 200μH, T <sub>J</sub> = 25°C Energy losses include tail & diode reverse recovery
E <sub>off</sub>	Turn-Off Switching Loss	—	1845	2725		
E <sub>total</sub>	Total Switching Loss	—	4455	6240		
t <sub>d(on)</sub>	Turn-On delay time	—	45	60	ns	
t <sub>r</sub>	Rise time	—	40	60		
t <sub>d(off)</sub>	Turn-Off delay time	—	410	450		
t <sub>f</sub>	Fall time	—	45	60		
E <sub>on</sub>	Turn-On Switching Loss	—	3790	—		
E <sub>off</sub>	Turn-Off Switching Loss	—	2905	—		
E <sub>total</sub>	Total Switching Loss	—	6695	—		
t <sub>d(on)</sub>	Turn-On delay time	—	40	—	ns	
t <sub>r</sub>	Rise time	—	40	—		
t <sub>d(off)</sub>	Turn-Off delay time	—	480	—		
t <sub>f</sub>	Fall time	—	200	—		
C <sub>ies</sub>	Input Capacitance	—	4820	—	pF	V <sub>GE</sub> = 0V V <sub>CC</sub> = 30V f = 1.0Mhz
C <sub>oes</sub>	Output Capacitance	—	150	—		
C <sub>res</sub>	Reverse Transfer Capacitance	—	110	—		
RBSOA	Reverse Bias Safe Operating Area	FULL SQUARE				T <sub>J</sub> = 150°C, I <sub>C</sub> = 160A V <sub>CC</sub> = 960V, V <sub>p</sub> ≤ 1200V R <sub>G</sub> = 10Ω, V <sub>GE</sub> = +20V to 0V
E <sub>rec</sub>	Reverse Recovery Energy of the Diode	—	1130	—	μJ	T <sub>J</sub> = 150°C
t <sub>rr</sub>	Diode Reverse Recovery Time	—	140	—	ns	V <sub>CC</sub> = 600V, I <sub>F</sub> = 40A
I <sub>rr</sub>	Peak Reverse Recovery Current	—	40	—	A	R <sub>G</sub> = 10Ω, L = 1.0mH

**Notes:**

- ① V<sub>CC</sub> = 80% (V<sub>CES</sub>), V<sub>GE</sub> = 20V, L = 200μH, R<sub>G</sub> = 10Ω.
- ② Pulse width limited by max. junction temperature.
- ③ Refer to AN-1086 for guidelines for measuring V<sub>(BR)CES</sub> safely.
- ④ R<sub>θ</sub> is measured at T<sub>J</sub> of approximately 90°C.
- ⑤ Values influenced by parasitic L and C of the test circuit.

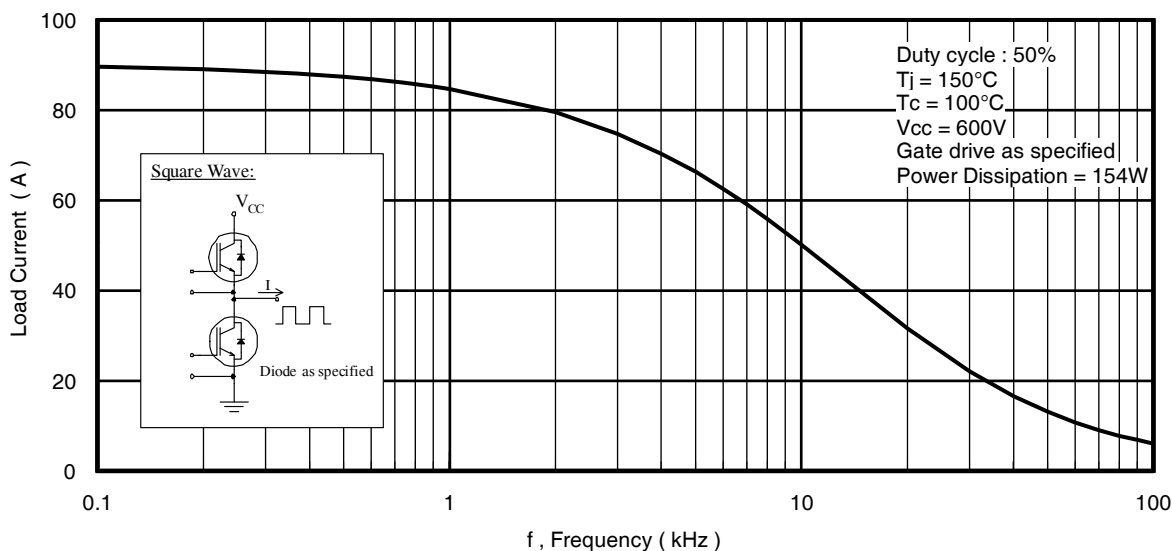

**Fig. 1 - Typical Load Current vs. Frequency**  
(Load Current =  $I_{RMS}$  of fundamental)

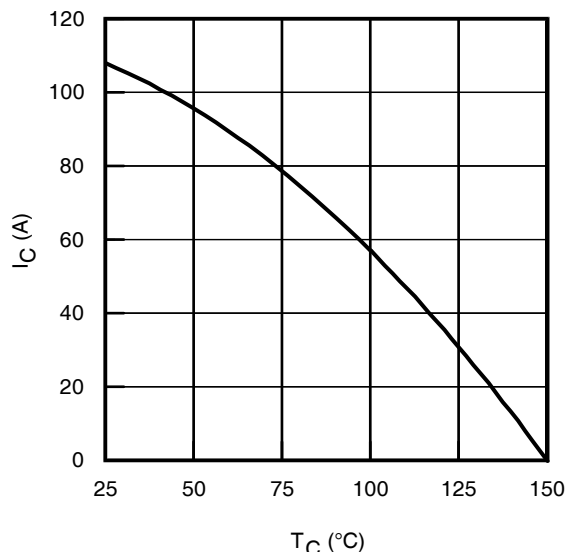

**Fig. 1 - Maximum DC Collector Current vs. Case Temperature**

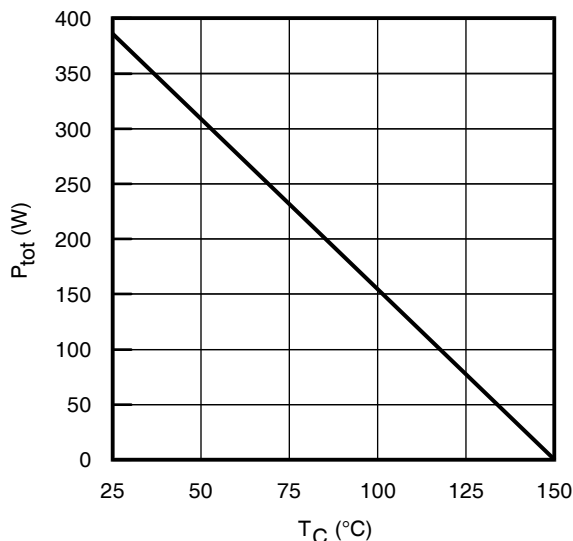

**Fig. 2 - Power Dissipation vs. Case Temperature**

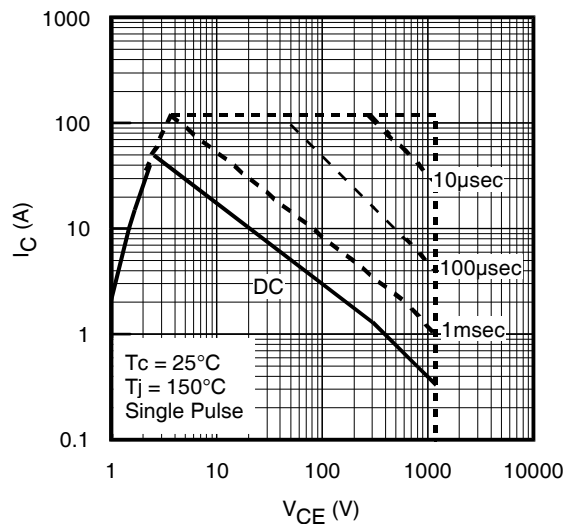

**Fig. 3 - Forward SOA**  
 $T_C = 25^\circ\text{C}$ ,  $T_J \leq 150^\circ\text{C}$ ;  $V_{GE} = 15\text{V}$

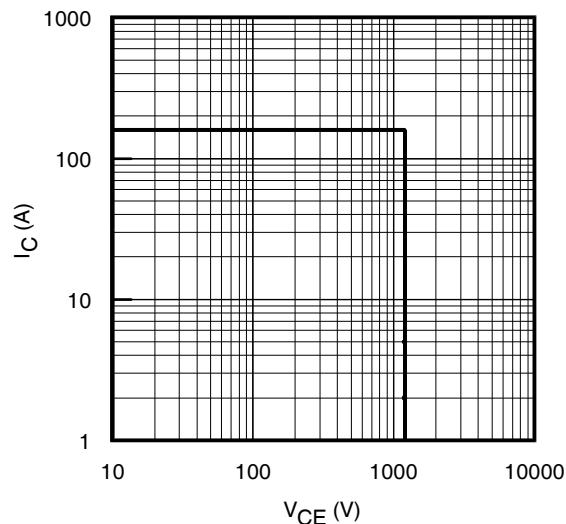

**Fig. 4 - Reverse Bias SOA**  
 $T_J = 150^\circ\text{C}$ ;  $V_{GE} = 20\text{V}$

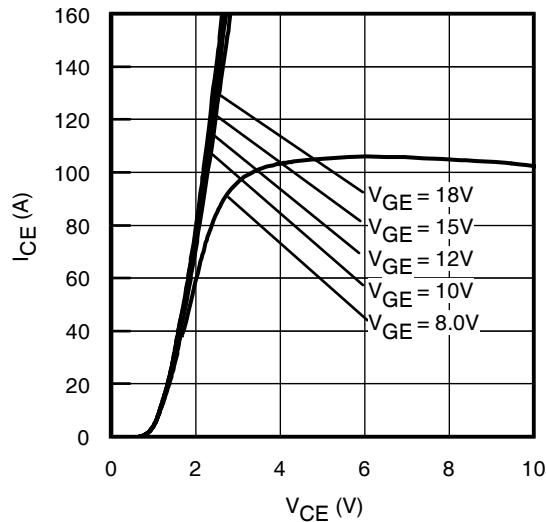

**Fig. 5** - Typ. IGBT Output Characteristics  
 $T_J = -40^\circ\text{C}$ ;  $t_p = 30\mu\text{s}$

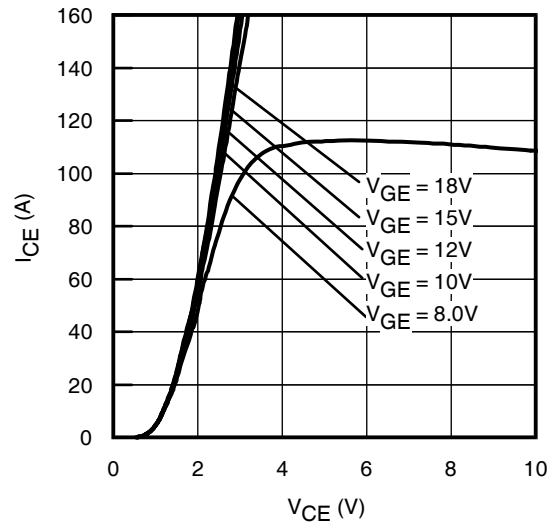

**Fig. 6** - Typ. IGBT Output Characteristics  
 $T_J = 25^\circ\text{C}$ ;  $t_p = 30\mu\text{s}$

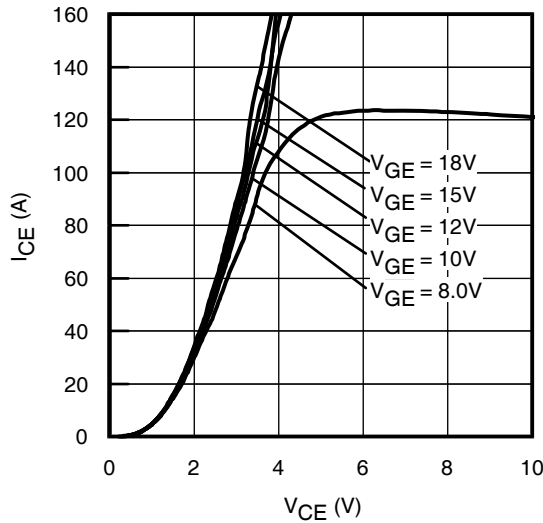

**Fig. 7** - Typ. IGBT Output Characteristics  
 $T_J = 150^\circ\text{C}$ ;  $t_p = 30\mu\text{s}$

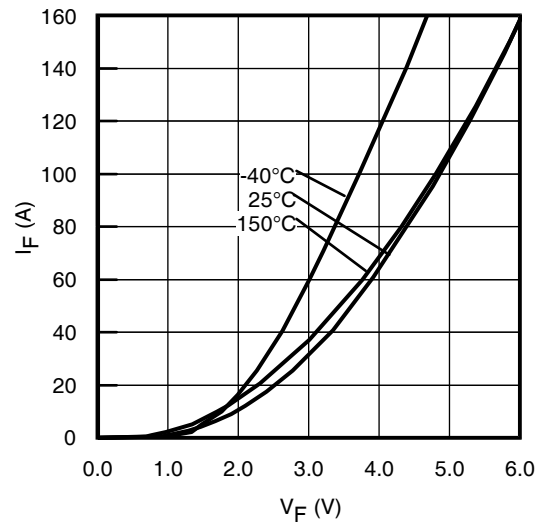

**Fig. 8** - Typ. Diode Forward Characteristics  
 $t_p = 30\mu\text{s}$

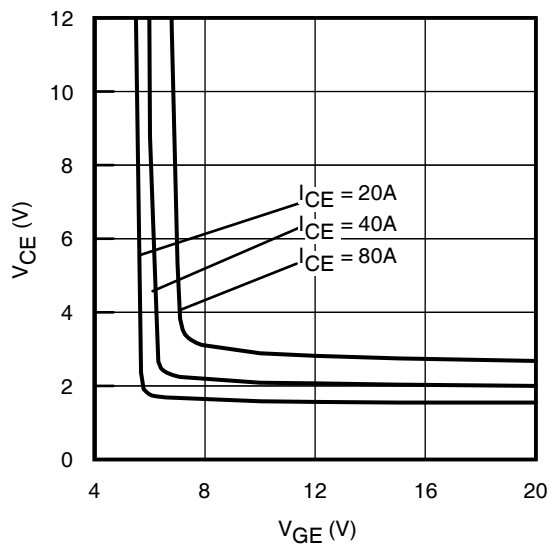

**Fig. 9** - Typical  $V_{CE}$  vs.  $V_{GE}$   
 $T_J = -40^\circ\text{C}$

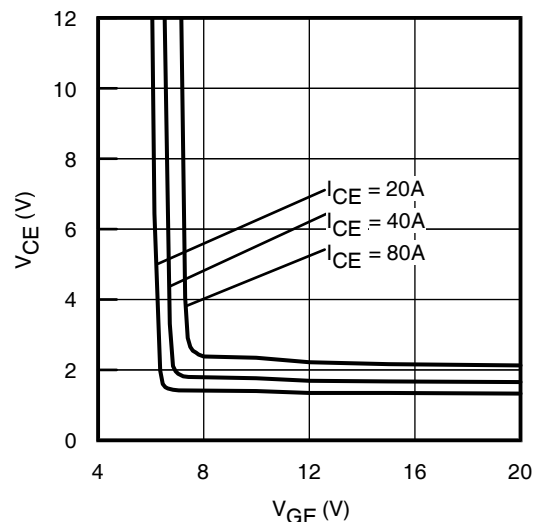

**Fig. 10** - Typical  $V_{CE}$  vs.  $V_{GE}$   
 $T_J = 25^\circ\text{C}$

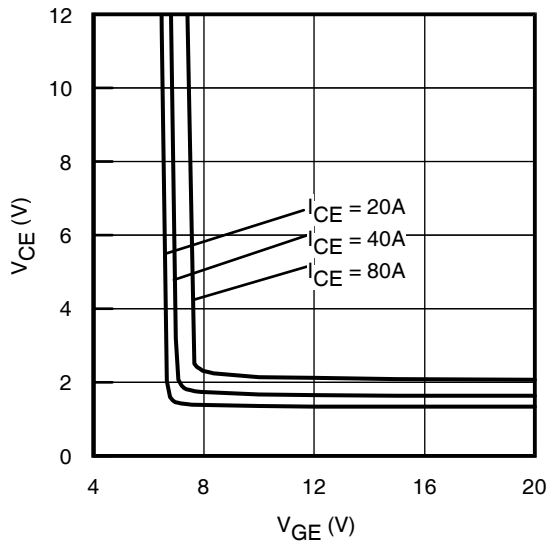

**Fig. 11** - Typical  $V_{CE}$  vs.  $V_{GE}$   
 $T_J = 150^\circ\text{C}$

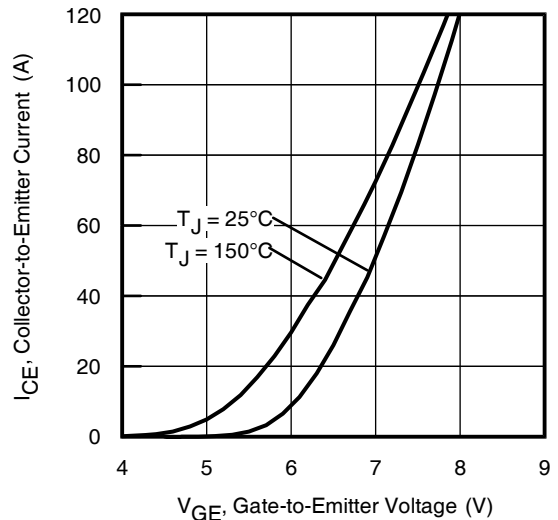

**Fig. 12** - Typ. Transfer Characteristics  
 $V_{CE} = 50\text{V}$

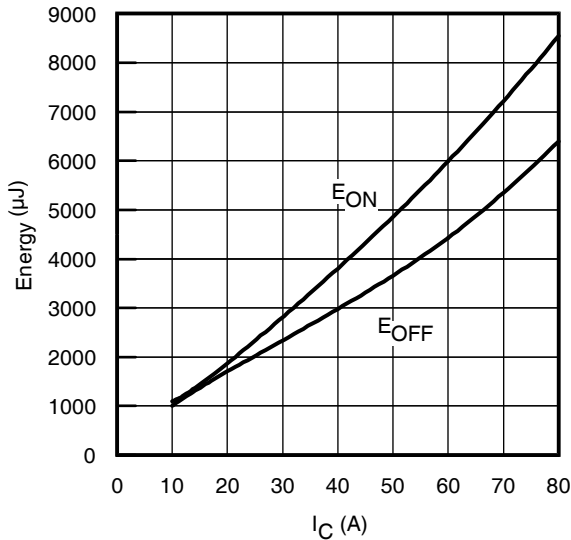

**Fig. 13** - Typ. Energy Loss vs.  $I_C$   
 $T_J = 150^\circ\text{C}$ ;  $L = 200\mu\text{H}$ ;  $V_{CE} = 600\text{V}$ ;  $R_G = 10\Omega$ ;  $V_{GE} = 15\text{V}$

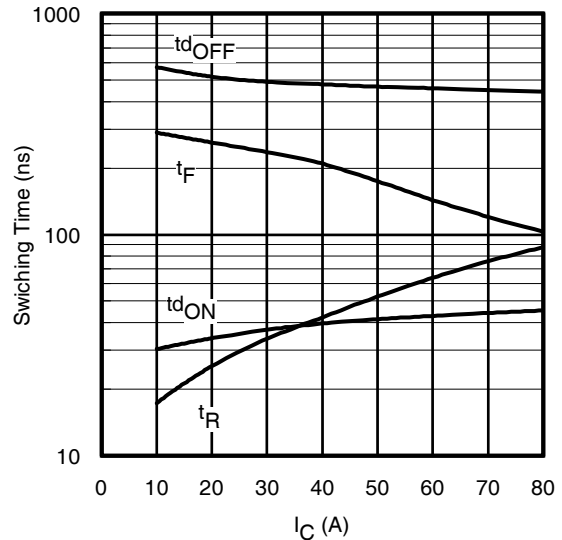

**Fig. 14** - Typ. Switching Time vs.  $I_C$   
 $T_J = 150^\circ\text{C}$ ;  $L = 200\mu\text{H}$ ;  $V_{CE} = 600\text{V}$ ;  $R_G = 10\Omega$ ;  $V_{GE} = 15\text{V}$

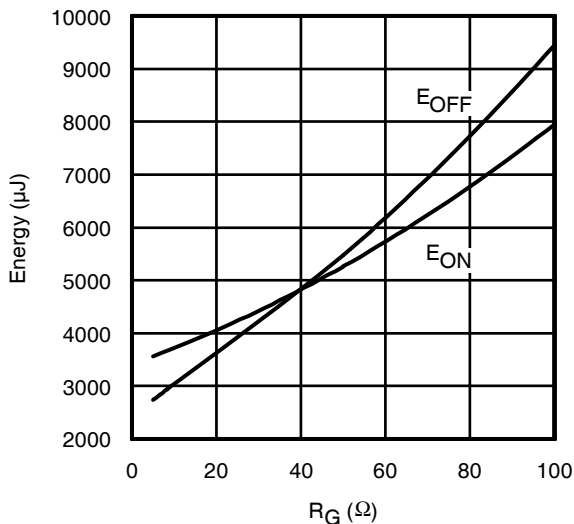

**Fig. 15** - Typ. Energy Loss vs.  $R_G$   
 $T_J = 150^\circ\text{C}$ ;  $L = 200\mu\text{H}$ ;  $V_{CE} = 600\text{V}$ ;  $I_{CE} = 40\text{A}$ ;  $V_{GE} = 15\text{V}$

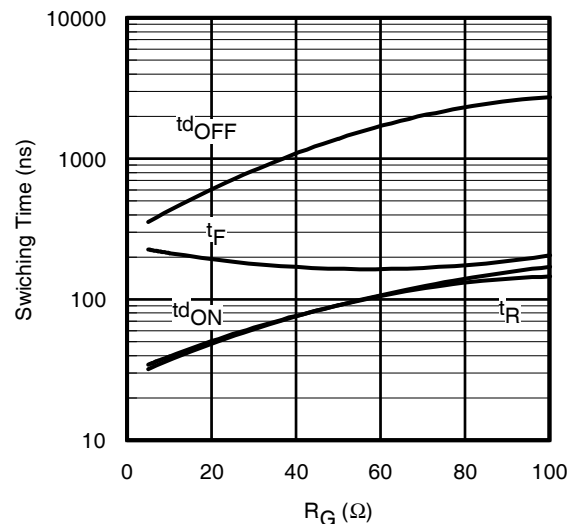

**Fig. 16** - Typ. Switching Time vs.  $R_G$   
 $T_J = 150^\circ\text{C}$ ;  $L = 200\mu\text{H}$ ;  $V_{CE} = 600\text{V}$ ;  $I_{CE} = 40\text{A}$ ;  $V_{GE} = 15\text{V}$

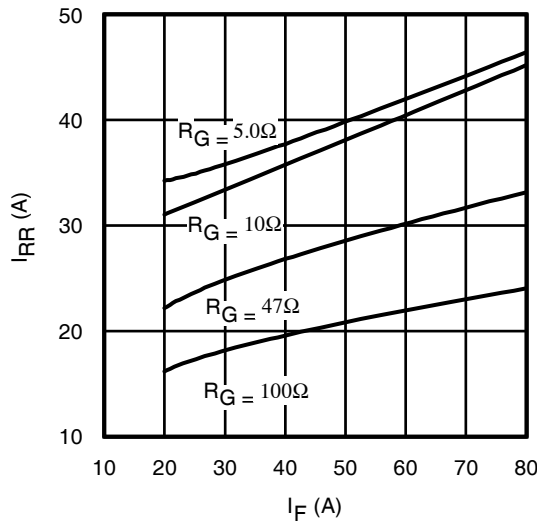

Fig. 17 - Typ. Diode  $I_{RR}$  vs.  $I_F$   
 $T_J = 150^\circ\text{C}$

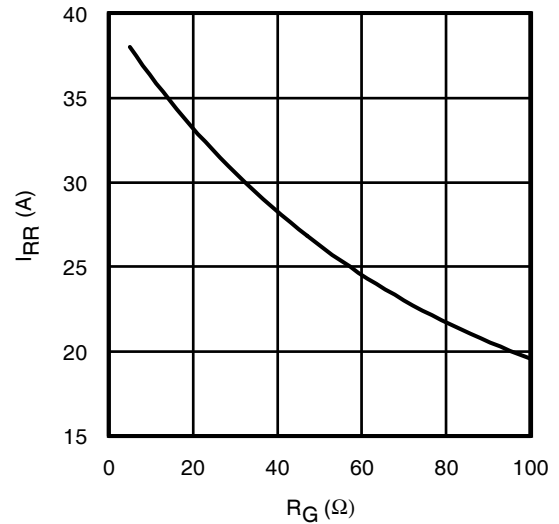

Fig. 18 - Typ. Diode  $I_{RR}$  vs.  $R_G$   
 $T_J = 150^\circ\text{C}$

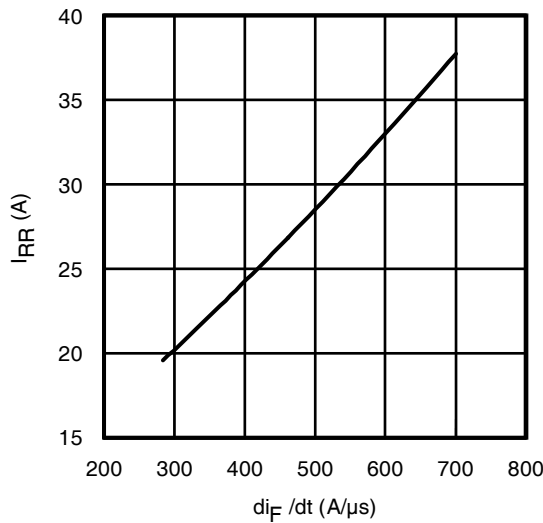

Fig. 19 - Typ. Diode  $I_{RR}$  vs.  $di_F/dt$   
 $V_{CC} = 600\text{V}$ ;  $V_{GE} = 15\text{V}$ ;  $I_F = 40\text{A}$ ;  $T_J = 150^\circ\text{C}$

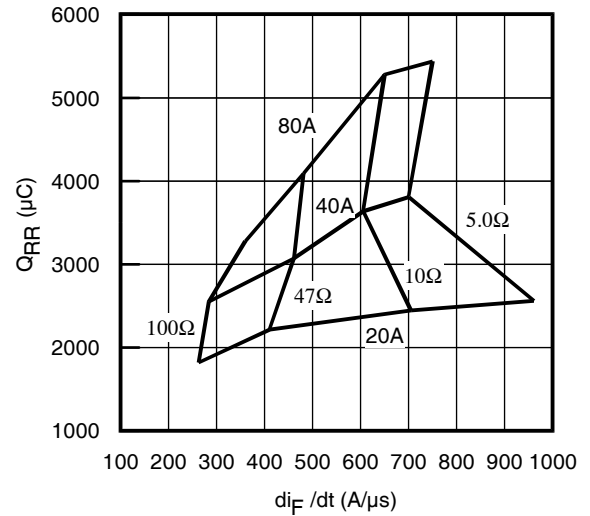

Fig. 20 - Typ. Diode  $Q_{RR}$  vs.  $di_F/dt$   
 $V_{CC} = 600\text{V}$ ;  $V_{GE} = 15\text{V}$ ;  $T_J = 150^\circ\text{C}$

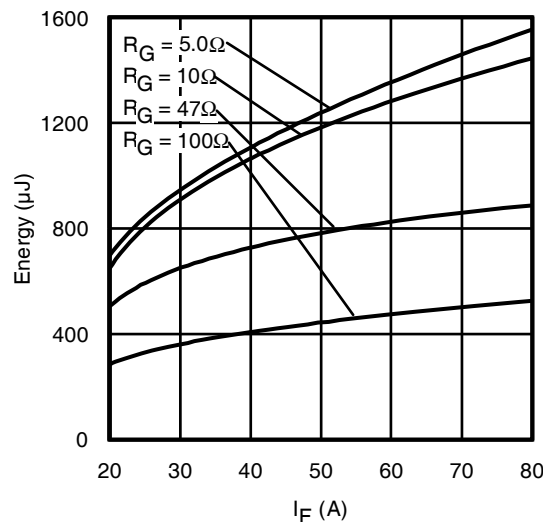
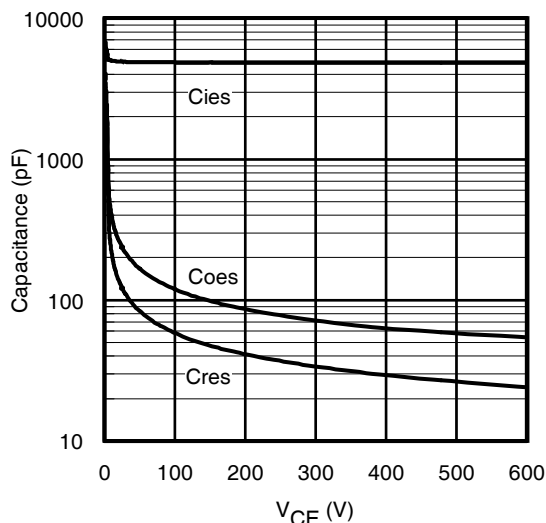
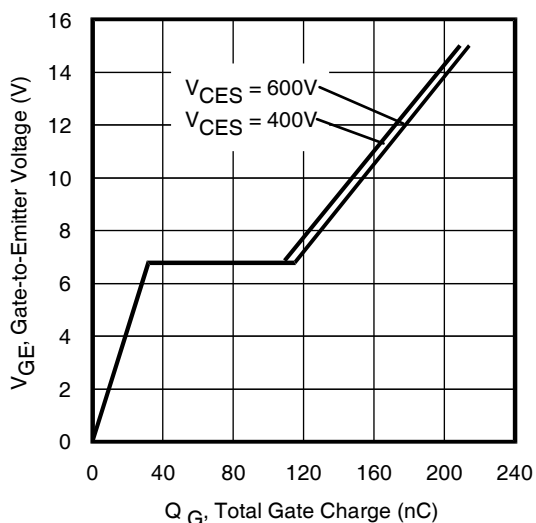

Fig. 21 - Typ. Diode  $E_{RR}$  vs.  $I_F$   
 $T_J = 150^\circ\text{C}$



**Fig. 22** - Typ. Capacitance vs.  $V_{CE}$   
 $V_{GE} = 0V$ ;  $f = 1MHz$



**Fig. 23** - Typical Gate Charge vs.  $V_{GE}$   
 $I_{CE} = 40A$ ;  $L = 2400H$

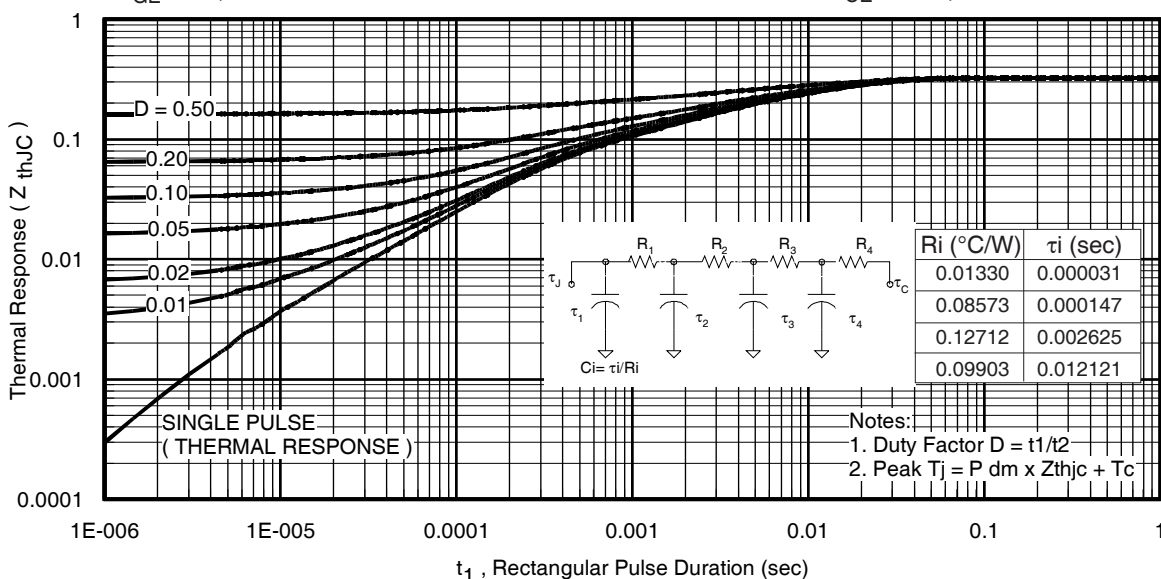

**Fig. 24.** Maximum Transient Thermal Impedance, Junction-to-Case (IGBT)

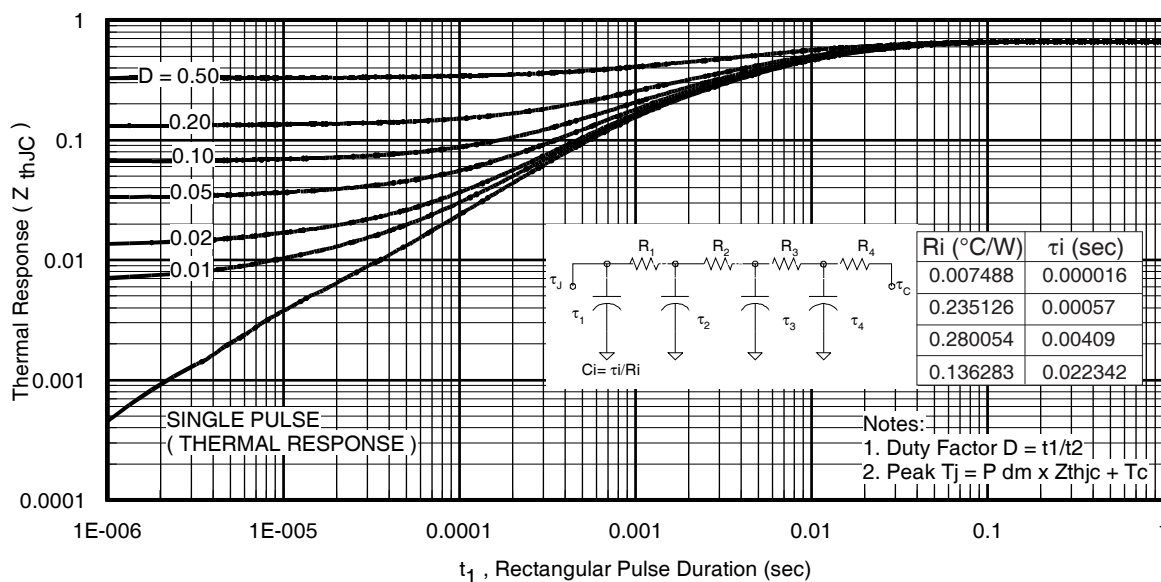

**Fig. 25.** Maximum Transient Thermal Impedance, Junction-to-Case (DIODE)

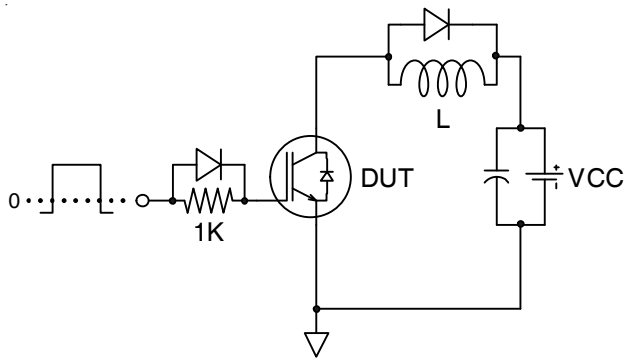

Fig.C.T.1 - Gate Charge Circuit (turn-off)

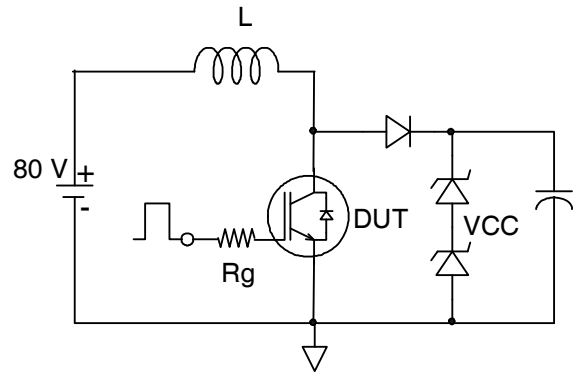

Fig.C.T.2 - RBSOA Circuit

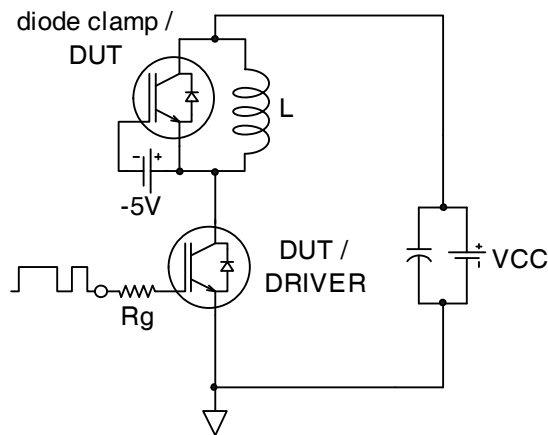

Fig.C.T.3 - Switching Loss Circuit

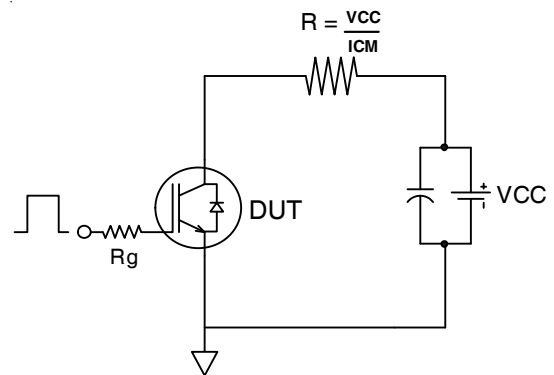

Fig.C.T.4 - Resistive Load Circuit

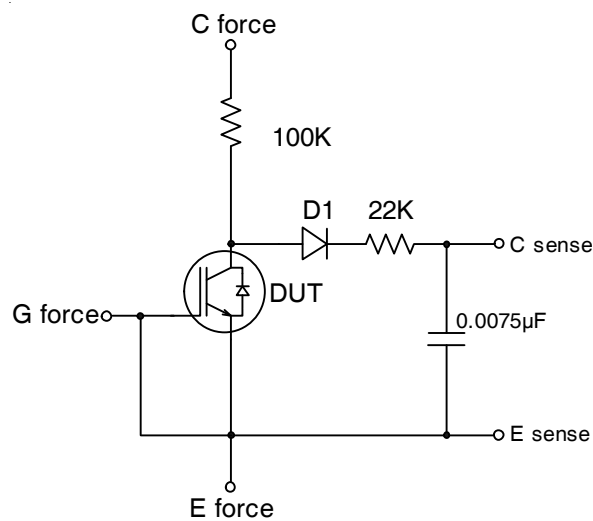
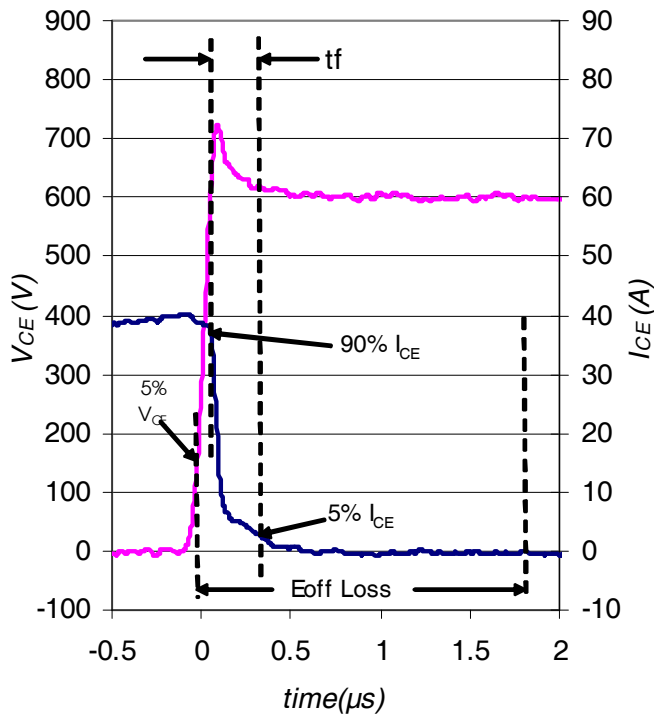
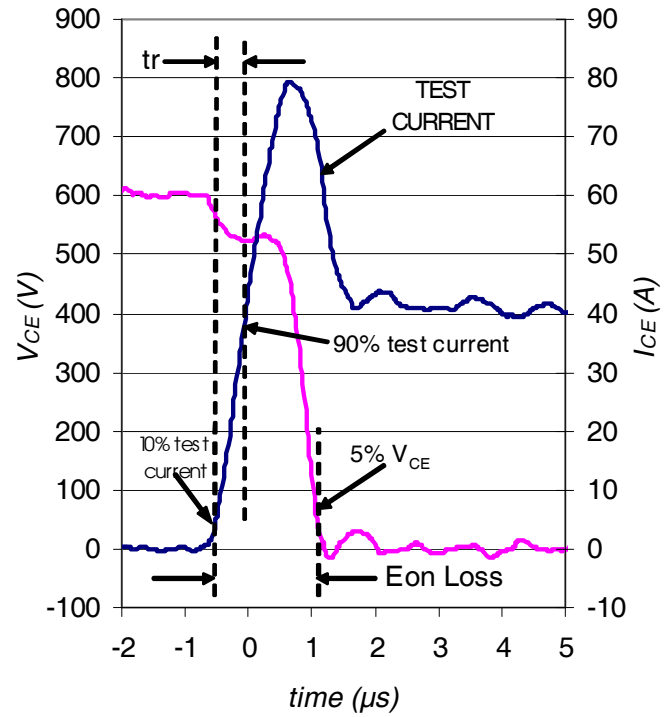

Fig.C.T.5 - BVCEs Filter Circuit

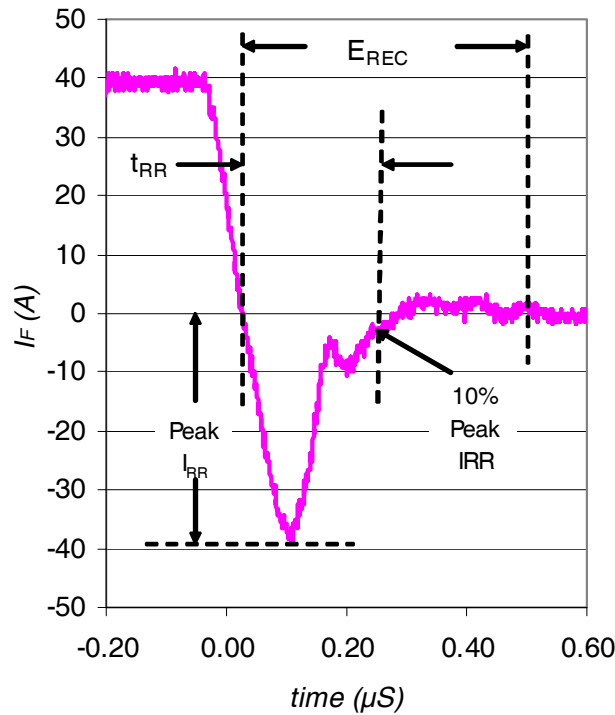



**Fig. WF1** - Typ. Turn-off Loss Waveform  
@  $T_J = 150^\circ\text{C}$  using Fig. CT.4



**Fig. WF2** - Typ. Turn-on Loss Waveform  
@  $T_J = 150^\circ\text{C}$  using Fig. CT.4



**Fig. WF3** - Typ. Diode Recovery Waveform  
@  $T_J = 150^\circ\text{C}$  using Fig. CT.4

## TO-247AC Package Outline

Dimensions are shown in millimeters (inches)

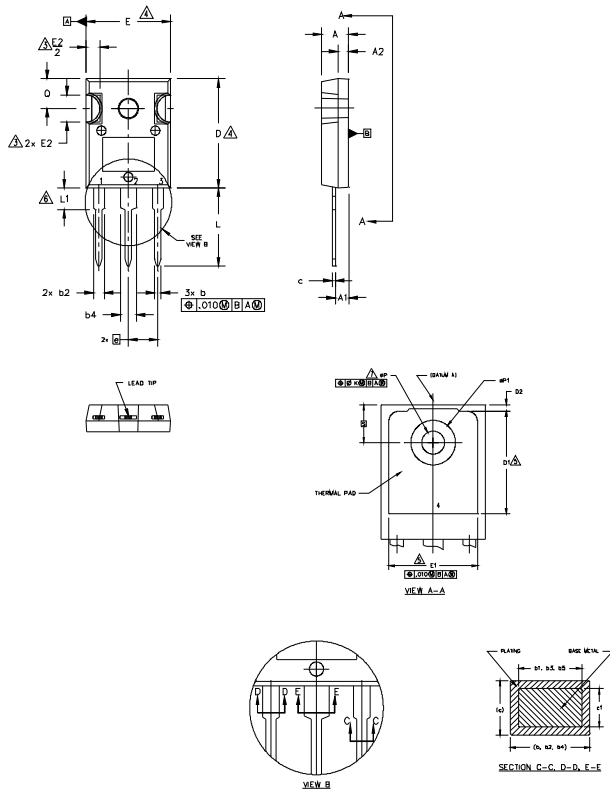

**NOTES:**

1. DIMENSIONING AND TOLERANCING AS PER ASME Y14.5M 1994.
2. DIMENSIONS ARE SHOWN IN INCHES.
3. CONTOUR OF SLOT OPTIONAL.
4. DIMENSION D & E DO NOT INCLUDE MOLD FLASH. MOLD FLASH SHALL NOT EXCEED .005" (0.127) PER SIDE. THESE DIMENSIONS ARE MEASURED AT THE OUTERMOST EXTREMES OF THE PLASTIC BODY.
5. THERMAL PAD CONTOUR OPTIONAL WITHIN DIMENSIONS D1 & E1.
6. LEAD FINISH UNCONTROLLED IN L1.
7. ØP TO HAVE A MAXIMUM DRAFT ANGLE OF 1.5 ° TO THE TOP OF THE PART WITH A MAXIMUM HOLE DIAMETER OF .154 INCH.
8. OUTLINE CONFORMS TO JEDEC OUTLINE TO-247AC .

SYMBOL	DIMENSIONS				NOTES
	INCHES		MILLIMETERS		
	MIN.	MAX.	MIN.	MAX.	
A	.183	.209	4.65	5.31	
A1	.087	.102	2.21	2.59	
A2	.059	.098	1.50	2.49	
b	.039	.055	0.99	1.40	
b1	.039	.053	0.99	1.35	
b2	.065	.094	1.65	2.39	
b3	.065	.092	1.65	2.34	
b4	.102	.135	2.59	3.43	
b5	.102	.133	2.59	3.38	
c	.015	.035	0.38	0.89	
c1	.015	.033	0.38	0.84	
D	.776	.815	19.71	20.70	4
D1	.515	-	13.08	-	5
D2	.020	.053	0.51	1.35	
E	.602	.625	15.29	15.87	4
E1	.530	-	13.46	-	
E2	.178	.216	4.52	5.49	
e	.215 BSC		5.46 BSC		
ek	.010		0.25		
L	.559	.634	14.20	16.10	
L1	.146	.169	3.71	4.29	
ØP	.140	.144	3.56	3.66	
ØP1	-	.291	-	7.39	
Q	.209	.224	5.31	5.69	
S	.217 BSC		5.51 BSC		

**LEAD ASSIGNMENTS**

**HEXFET**

- 1.- GATE
- 2.- DRAIN
- 3.- SOURCE
- 4.- DRAIN

**IGBTs, CoPACK**

- 1.- GATE
- 2.- COLLECTOR
- 3.- EMITTER
- 4.- COLLECTOR

**DIODES**

- 1.- ANODE/OPEN
- 2.- CATHODE
- 3.- ANODE

## TO-247AC Part Marking Information

EXAMPLE: THIS IS AN IRFPE30  
WITH ASSEMBLY  
LOT CODE 5657  
ASSEMBLED ON WW 35, 2001  
IN THE ASSEMBLY LINE "H"

Note: "P" in assembly line position  
indicates "Lead-Free"

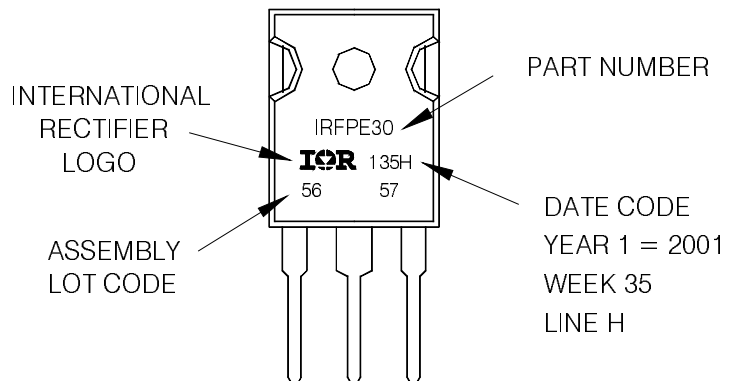

TO-247AC package is not recommended for Surface Mount Application.

Note: For the most current drawing please refer to IR website at <http://www.irf.com/package/>

## TO-247AD Package Outline

Dimensions are shown in millimeters (inches)

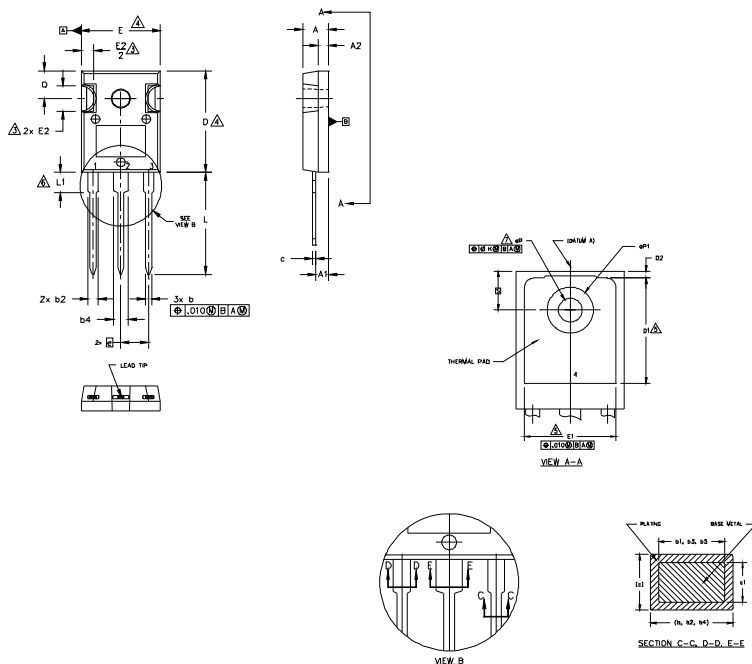

**NOTES:**

1. DIMENSIONING AND TOLERANCING AS PER ASME Y14.5M 1994.
2. DIMENSIONS ARE SHOWN IN INCHES.
3. CONTOUR OF SLOT OPTIONAL.
4. DIMENSION D & E DO NOT INCLUDE MOLD FLASH. MOLD FLASH SHALL NOT EXCEED .005" (0.127) PER SIDE. THESE DIMENSIONS ARE MEASURED AT THE OUTERMOST EXTREMES OF THE PLASTIC BODY.
5. THERMAL PAD CONTOUR OPTIONAL WITHIN DIMENSIONS D1 & E1.
6. LEAD FINISH UNCONTROLLED IN L1.
7.  $\phi P$  TO HAVE A MAXIMUM DRAFT ANGLE OF 1.5° TO THE TOP OF THE PART WITH A MAXIMUM HOLE DIAMETER OF .154 INCH.
8. OUTLINE CONFORMS TO JEDEC OUTLINE TO-247AD.

SYMBOL	DIMENSIONS				NOTES
	INCHES		MILLIMETERS		
A	.183	.209	4.65	5.31	
A1	.087	.102	2.21	2.59	
A2	.059	.098	1.50	2.49	
b	.039	.055	0.99	1.40	
b1	.039	.053	0.99	1.35	
b2	.065	.094	1.65	2.39	
b3	.065	.092	1.65	2.34	
b4	.102	.135	2.59	3.43	
b5	.102	.133	2.59	3.38	
c	.015	.035	0.38	0.89	
c1	.015	.033	0.38	0.84	
D	.776	.815	19.71	20.70	4
D1	.515	-	13.08	-	5
D2	.020	.053	0.51	1.35	4
E	.602	.625	15.29	15.87	
E1	.530	-	13.46	-	
E2	.178	.216	4.52	5.49	
e	.215 BSC		5.46 BSC		
$\phi k$	.010		0.25		
L	.780	.827	19.57	21.00	
L1	.146	.169	3.71	4.29	
$\phi P$	.140	.144	3.56	3.66	
$\phi P1$	-	.291	-	7.39	
Q	.209	.224	5.31	5.69	
S	.217 BSC		5.51 BSC		

**LEAD ASSIGNMENTS**

**HEXFET**

- 1.- GATE
- 2.- DRAIN
- 3.- SOURCE
- 4.- DRAIN

**IGBTs, CoPACK**

- 1.- GATE
- 2.- COLLECTOR
- 3.- EMITTER
- 4.- COLLECTOR

**DIODES**

- 1.- ANODE/OPEN
- 2.- CATHODE
- 3.- ANODE

## TO-247AD Part Marking Information

EXAMPLE: THIS IS AN IRGP30B120KD-E  
WITH ASSEMBLY  
LOT CODE 5657  
ASSEMBLED ON WW 35, 2000  
IN THE ASSEMBLY LINE "H"

Note: "P" in assembly line position  
indicates "Lead-Free"

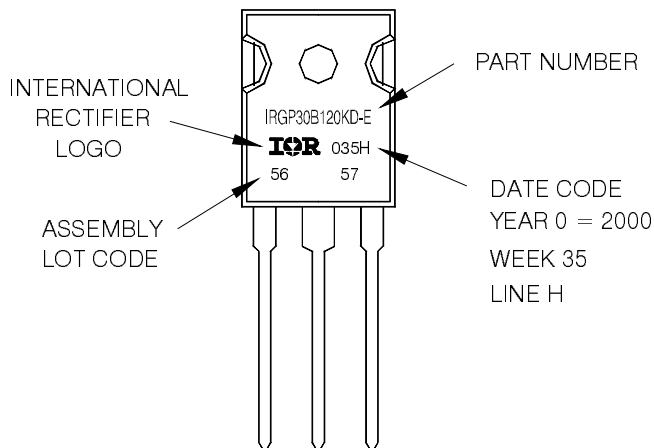

TO-247AD package is not recommended for Surface Mount Application.

Note: For the most current drawing please refer to IR website at <http://www.irf.com/package/>

# Mouser Electronics

Authorized Distributor

Click to View Pricing, Inventory, Delivery & Lifecycle Information:

[Infineon:](#)

[IRG7PH46UDPBF](#) [IRG7PH46UD-EP](#)