

### Features

- Low  $C_{RES} / C_{IES}$  ratio (no cross conduction susceptibility)
- IGBT co-packaged with ultra fast free-wheeling diode

### Applications

- High frequency inverters
- UPS
- Motor drivers
- Induction heating

### Description

This IGBT utilizes the advanced PowerMESH™ process resulting in an excellent trade-off between switching performance and low on-state behavior.

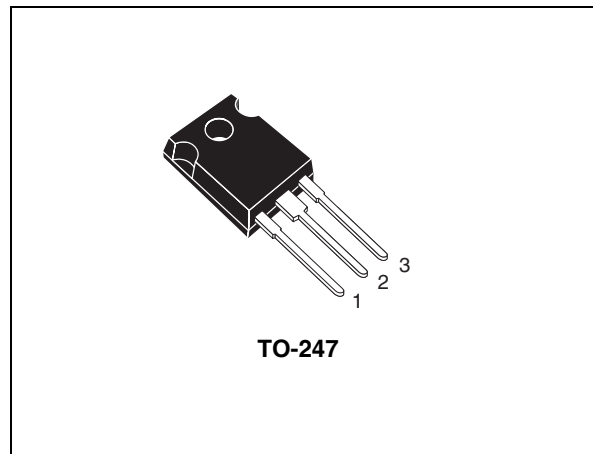

Figure 1. Internal schematic diagram

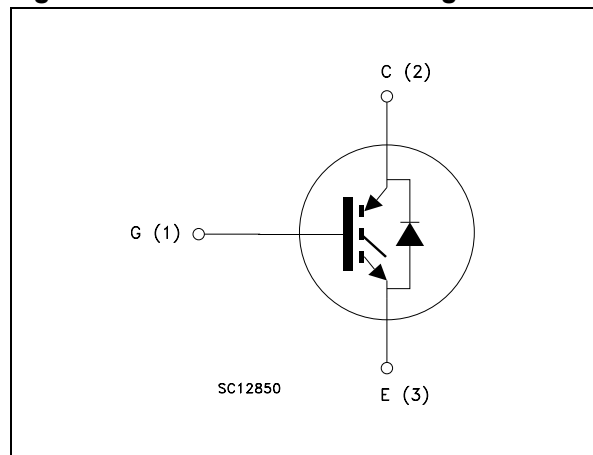

Table 1. Device summary

Order code	Marking	Package	Packaging
STGW39NC60VD	GW39NC60VD	TO-247	Tube

# Contents

<b>1</b>	<b>Electrical ratings</b> .....	<b>3</b>
<b>2</b>	<b>Electrical characteristics</b> .....	<b>4</b>
	2.1 Electrical characteristics (curves) .....	6
	2.2 Frequency applications .....	9
<b>3</b>	<b>Test circuit</b> .....	<b>10</b>
<b>4</b>	<b>Package mechanical data</b> .....	<b>11</b>
<b>5</b>	<b>Revision history</b> .....	<b>13</b>

# 1 Electrical ratings

**Table 2. Absolute maximum ratings**

Symbol	Parameter	Value	Unit
$V_{CES}$	Collector-emitter voltage ( $V_{GE} = 0$ )	600	V
$I_C^{(1)}$	Collector current (continuous) at 25 °C	80	A
$I_C^{(1)}$	Collector current (continuous) at 100 °C	40	A
$I_{CL}^{(2)}$	Turn-off latching current	220	A
$I_{CP}^{(3)}$	Pulsed collector current	220	A
$V_{GE}$	Gate-emitter voltage	± 20	V
$I_F$	Diode RMS forward current at $T_C = 25$ °C	30	A
$I_{FSM}$	Surge non repetitive forward current (tp=10 ms sinusoidal)	120	A
$P_{TOT}$	Total dissipation at $T_C = 25$ °C	250	W
$T_j$	Operating junction temperature	- 55 to 150	°C

1. Calculated according to the iterative formula:

$$I_C(T_C) = \frac{T_{JMAX} - T_C}{R_{THJ-C} \times V_{CESAT(MAX)}(T_C) \cdot I_C}$$

2.  $V_{clamp} = 80\%(V_{CES})$ ,  $T_j = 150$  °C,  $R_G = 10$  Ω,  $V_{GE} = 15$  V

3. Pulse width limited by max. junction temperature allowed

**Table 3. Thermal resistance**

Symbol	Parameter	Value	Unit
$R_{thj-case}$	Thermal resistance junction-case (IGBT) max	0.5	°C/W
$R_{thj-case}$	Thermal resistance junction-case (diode) max	1.5	°C/W
$R_{thj-amb}$	Thermal resistance junction-ambient max	50	°C/W

## 2 Electrical characteristics

( $T_{CASE}=25\text{ °C}$  unless otherwise specified)

**Table 4. Static**

Symbol	Parameter	Test conditions	Min.	Typ.	Max.	Unit
$V_{(BR)CES}$	Collector-emitter breakdown voltage ( $V_{GE} = 0$ )	$I_C = 1\text{ mA}$	600			V
$V_{CE(sat)}$	Collector-emitter saturation voltage	$V_{GE} = 15\text{ V}$ , $I_C = 30\text{ A}$ $V_{GE} = 15\text{ V}$ , $I_C = 30\text{ A}$ , $T_C = 125\text{ °C}$		1.8 1.7	2.4	V V
$V_{GE(th)}$	Gate threshold voltage	$V_{CE} = V_{GE}$ , $I_C = 1\text{ mA}$	3.75		5.75	V
$I_{CES}$	Collector cut-off current ( $V_{GE} = 0$ )	$V_{CE} = 600\text{ V}$ $V_{CE} = 600\text{ V}$ , $T_C = 125\text{ °C}$			500 5	$\mu\text{A}$ mA
$I_{GES}$	Gate-emitter leakage current ( $V_{CE} = 0$ )	$V_{GE} = \pm 20\text{ V}$			$\pm 100$	nA
$g_{fs}^{(1)}$	Forward transconductance	$V_{CE} = 15\text{ V}$ , $I_C = 30\text{ A}$		20		S

1. Pulsed: pulse duration = 300  $\mu\text{s}$ , duty cycle 1.5%

**Table 5. Dynamic**

Symbol	Parameter	Test conditions	Min.	Typ.	Max.	Unit
$C_{ies}$	Input capacitance	$V_{CE} = 25\text{ V}$ , $f = 1\text{ MHz}$ , $V_{GE} = 0$		2900		pF
$C_{oes}$	Output capacitance			298		pF
$C_{res}$	Reverse transfer capacitance			59		pF
$Q_g$	Total gate charge	$V_{CE} = 390\text{ V}$ , $I_C = 30\text{ A}$ , $V_{GE} = 15\text{ V}$ (see Figure 19)		126		nC
$Q_{ge}$	Gate-emitter charge			16		nC
$Q_{gc}$	Gate-collector charge			46		nC

**Table 6. Switching on/off (inductive load)**

Symbol	Parameter	Test conditions	Min.	Typ.	Max.	Unit
$t_{d(on)}$	Turn-on delay time	$V_{CC} = 390\text{ V}, I_C = 30\text{ A},$ $R_G = 10\ \Omega, V_{GE} = 15\text{ V}$ <i>(see Figure 18)</i>		33		ns
$t_r$	Current rise time			13		ns
$(di/dt)_{onf}$	Turn-on current slope				2500	
$t_{d(on)}$	Turn-on delay time	$V_{CC} = 390\text{ V}, I_C = 30\text{ A},$ $R_G = 10\ \Omega, V_{GE} = 15\text{ V}$ $T_C = 125\text{ }^\circ\text{C}$ <i>(see Figure 18)</i>		32		ns
$t_r$	Current rise time			14		ns
$(di/dt)_{on}$	Turn-on current slope				2280	
$t_{r(Voff)}$	Off voltage rise time	$V_{CC} = 390\text{ V}, I_C = 30\text{ A},$ $R_G = 10\ \Omega, V_{GE} = 15\text{ V}$ <i>(see Figure 18)</i>		33		ns
$t_{d(off)}$	Turn-off delay time			178		ns
$t_f$	Current fall time				65	
$t_{r(Voff)}$	Off voltage rise time	$V_{CC} = 390\text{ V}, I_C = 30\text{ A},$ $R_G = 10\ \Omega, V_{GE} = 15\text{ V}$ $T_C = 125\text{ }^\circ\text{C}$ <i>(see Figure 18)</i>		68		ns
$t_{d(off)}$	Turn-off delay time			238		ns
$t_f$	Current fall time				128	

**Table 7. Switching energy (inductive load)**

Symbol	Parameter	Test conditions	Min.	Typ.	Max.	Unit
$E_{on}^{(1)}$	Turn-on switching losses	$V_{CC} = 390\text{ V}, I_C = 30\text{ A}$ $R_G = 10\ \Omega, V_{GE} = 15\text{ V},$ <i>(see Figure 20)</i>		333		$\mu$ J
$E_{off}^{(2)}$	Turn-off switching losses			537		$\mu$ J
$E_{ts}$	Total switching losses				870	
$E_{on}^{(1)}$	Turn-on switching losses	$V_{CC} = 390\text{ V}, I_C = 30\text{ A}$ $R_G = 10\ \Omega, V_{GE} = 15\text{ V},$ $T_C = 125\text{ }^\circ\text{C}$ <i>(see Figure 20)</i>		618		$\mu$ J
$E_{off}^{(2)}$	Turn-off switching losses			1125		$\mu$ J
$E_{ts}$	Total switching losses				1743	

1.  $E_{on}$  is the turn-on losses when a typical diode is used in the test circuit in figure 2  $E_{on}$  include diode recovery energy. If the IGBT is offered in a package with a co-pak diode, the co-pak diode is used as external diode. IGBTs & Diode are at the same temperature (25°C and 125°C)
2. Turn-off losses include also the tail of the collector current

Table 8. Collector-emitter diode

Symbol	Parameter	Test conditions	Min.	Typ.	Max.	Unit
$V_F$	Forward on-voltage	$I_F = 30\text{ A}$ $I_F = 30\text{ A}, T_C = 125\text{ °C}$		2.4		V
				1.8		V
$t_{rr}$	Reverse recovery time	$I_F = 30\text{ A}, V_R = 50\text{ V},$ $di/dt = 100\text{ A}/\mu\text{s}$ <i>(see Figure 21)</i>		45		ns
$Q_{rr}$	Reverse recovery charge			56		nC
$I_{rrm}$	Reverse recovery current			2.55		A
$t_{rr}$	Reverse recovery time	$I_F = 30\text{ A}, V_R = 50\text{ V},$ $T_C = 125\text{ °C},$ $di/dt = 100\text{ A}/\mu\text{s}$ <i>(see Figure 21)</i>		100		ns
$Q_{rr}$	Reverse recovery charge			290		nC
$I_{rrm}$	Reverse recovery current			5.8		A

## 2.1 Electrical characteristics (curves)

Figure 2. Output characteristics

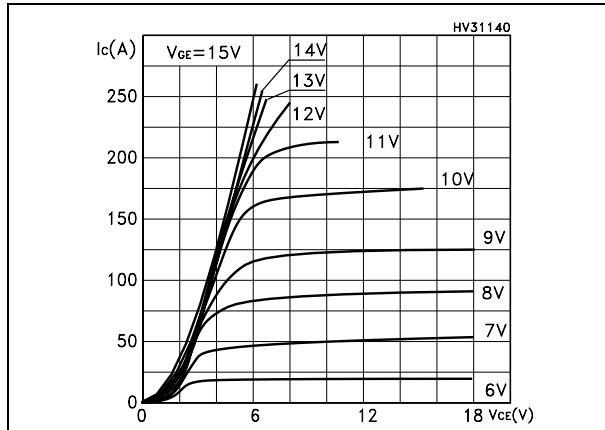

Figure 3. Transfer characteristics

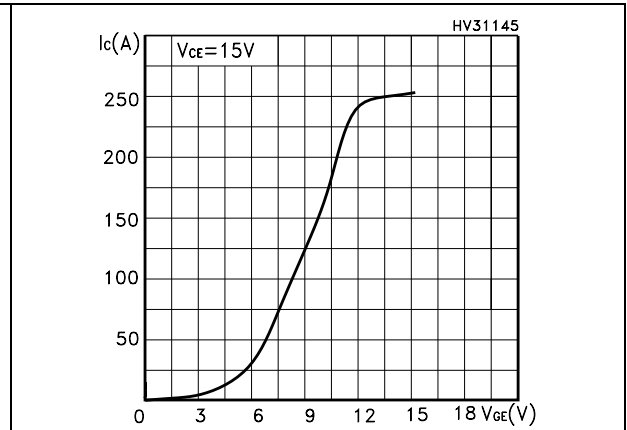

Figure 4. Transconductance

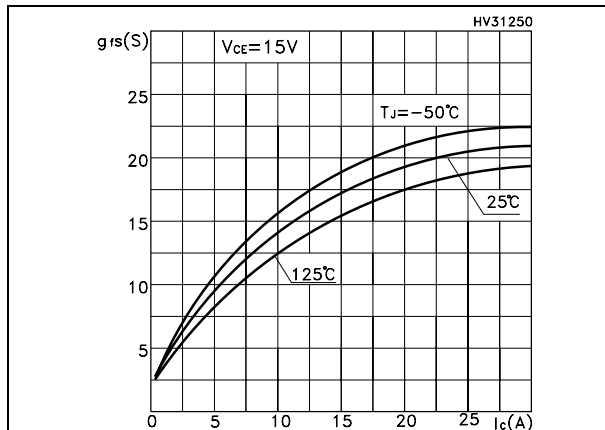

Figure 5. Collector-emitter on voltage vs temperature

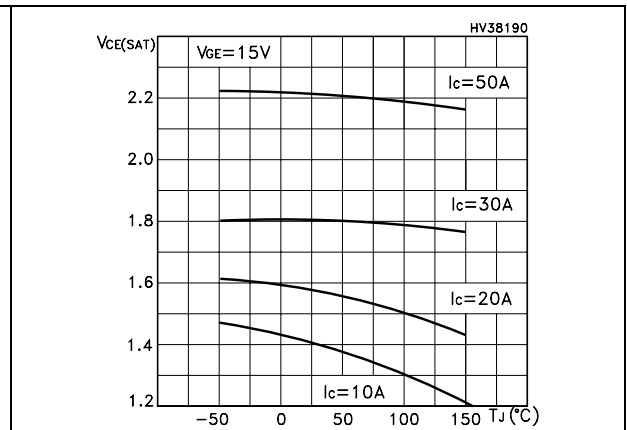

Figure 6. Collector-emitter on voltage vs collector current

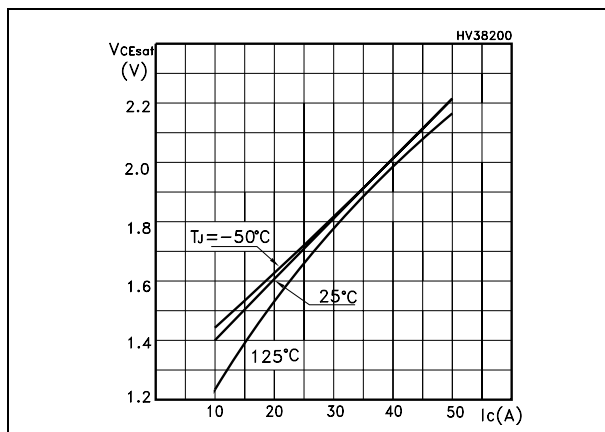

Figure 7. Normalized gate threshold vs temperature

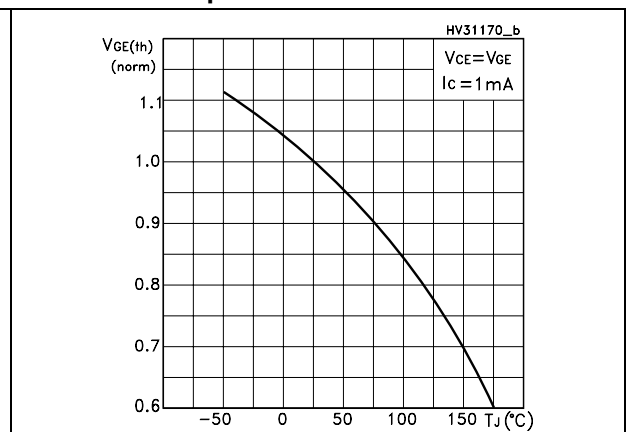

Figure 8. Normalized breakdown voltage vs temperature

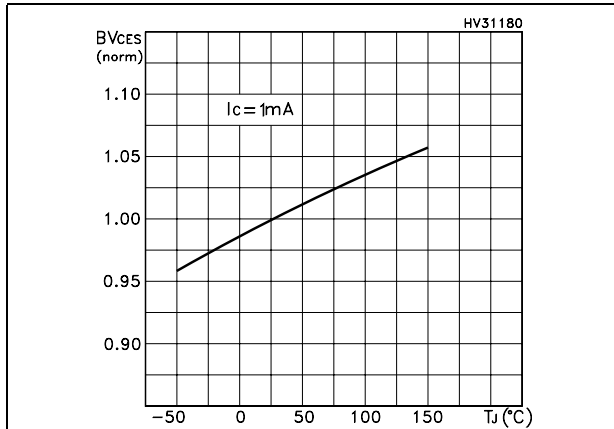

Figure 9. Gate charge vs gate-emitter voltage

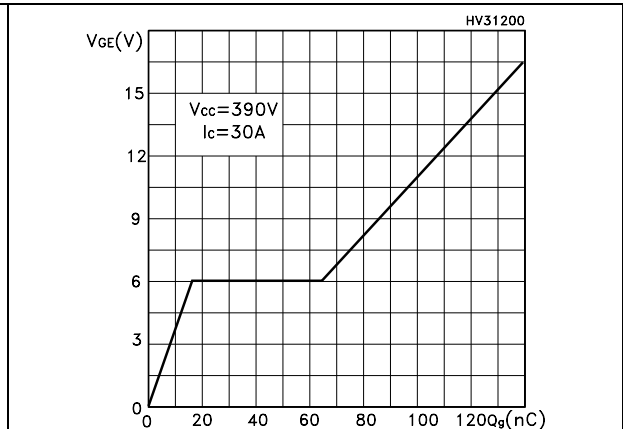

Figure 10. Capacitance variations

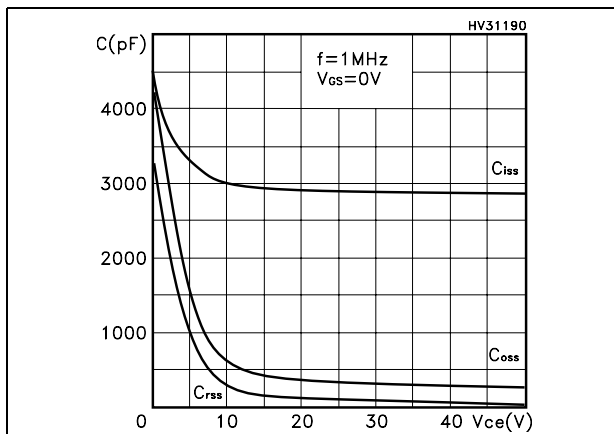

Figure 11. Switching losses vs temperature

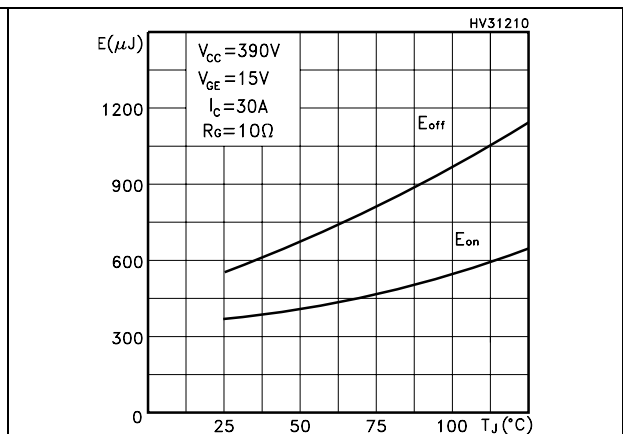

Figure 12. Switching losses vs gate resistance Figure 13. Switching losses vs collector current

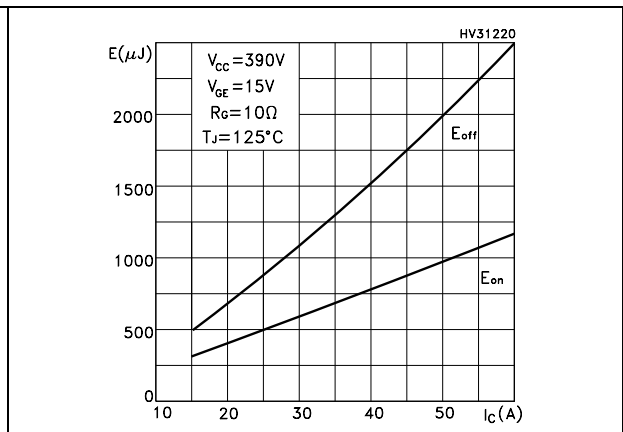
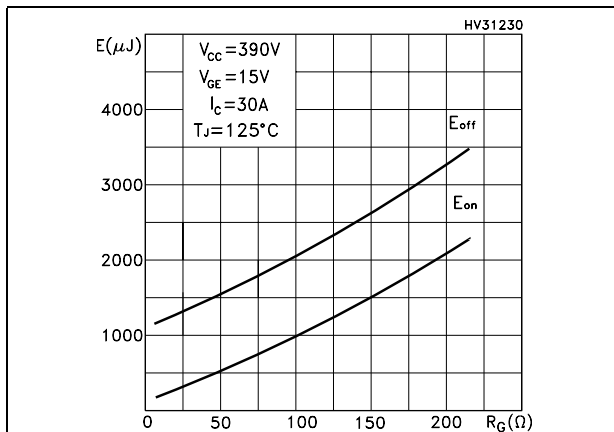



Figure 14. Thermal impedance

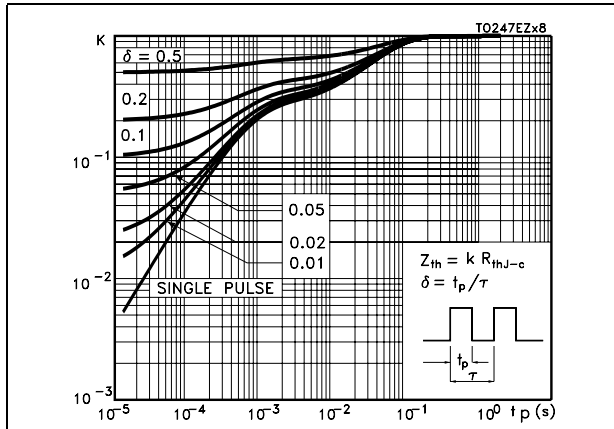

Figure 15. Turn-off SOA

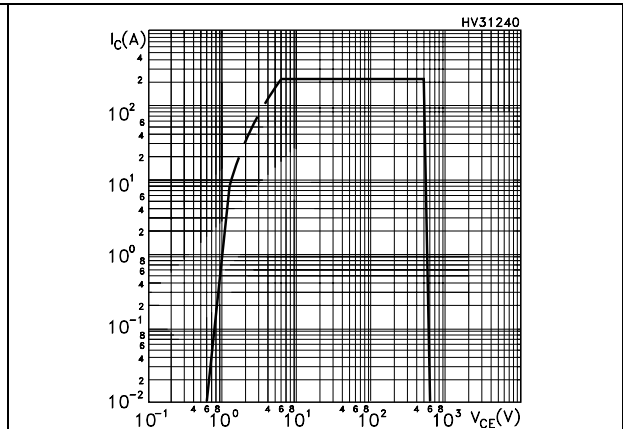

Figure 16. Emitter-collector diode characteristics

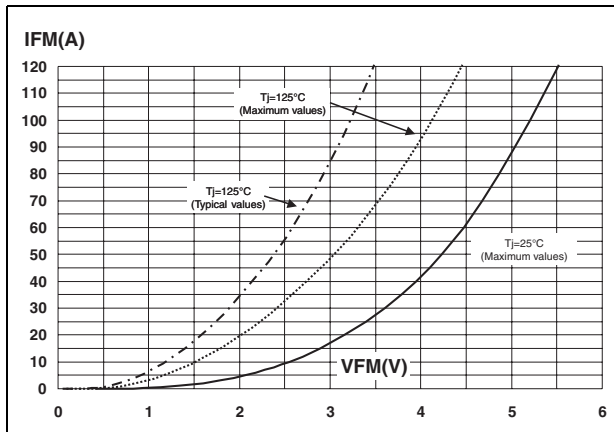
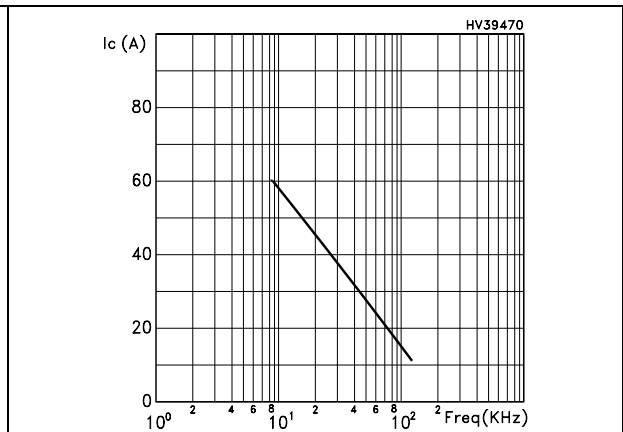

Figure 17. Ic vs. frequency



## 2.2 Frequency applications

For a fast IGBT suitable for high frequency applications, the typical collector current vs. maximum operating frequency curve is reported. That frequency is defined as follows:

$$f_{MAX} = (P_D - P_C) / (E_{ON} + E_{OFF})$$

- The maximum power dissipation is limited by maximum junction to case thermal resistance:

### Equation 1

$$P_D = \Delta T / R_{THJ-C}$$

considering  $\Delta T = T_J - T_C = 125\text{ }^\circ\text{C} - 75\text{ }^\circ\text{C} = 50\text{ }^\circ\text{C}$

- The conduction losses are:

**Equation 2**

$$P_C = I_C * V_{CE(SAT)} * \delta$$

with 50% of duty cycle,  $V_{CESAT}$  typical value @ 125 °C.

- Power dissipation during ON & OFF commutations is due to the switching frequency:

**Equation 3**

$P_{SW} = (E_{ON} + E_{OFF}) * \text{freq.}$  Typical values @ 125 °C for switching losses are used (test conditions:  $V_{CE} = 390 \text{ V}$ ,  $V_{GE} = 15 \text{ V}$ ,  $R_G = 10 \Omega$ ). Furthermore, diode recovery energy is included in the  $E_{ON}$  (see note 2), while the tail of the collector current is included in the  $E_{OFF}$  measurements (see note 3).



## 4 Package mechanical data

In order to meet environmental requirements, ST offers these devices in ECOPACK® packages. These packages have a lead-free second level interconnect. The category of second level interconnect is marked on the package and on the inner box label, in compliance with JEDEC Standard JESD97. The maximum ratings related to soldering conditions are also marked on the inner box label. ECOPACK is an ST trademark. ECOPACK specifications are available at: [www.st.com](http://www.st.com)

## TO-247 mechanical data

Dim.	mm.		
	Min.	Typ	Max.
A	4.85		5.15
A1	2.20		2.60
b	1.0		1.40
b1	2.0		2.40
b2	3.0		3.40
c	0.40		0.80
D	19.85		20.15
E	15.45		15.75
e		5.45	
L	14.20		14.80
L1	3.70		4.30
L2		18.50	
$\varnothing P$	3.55		3.65
$\varnothing R$	4.50		5.50
S		5.50	

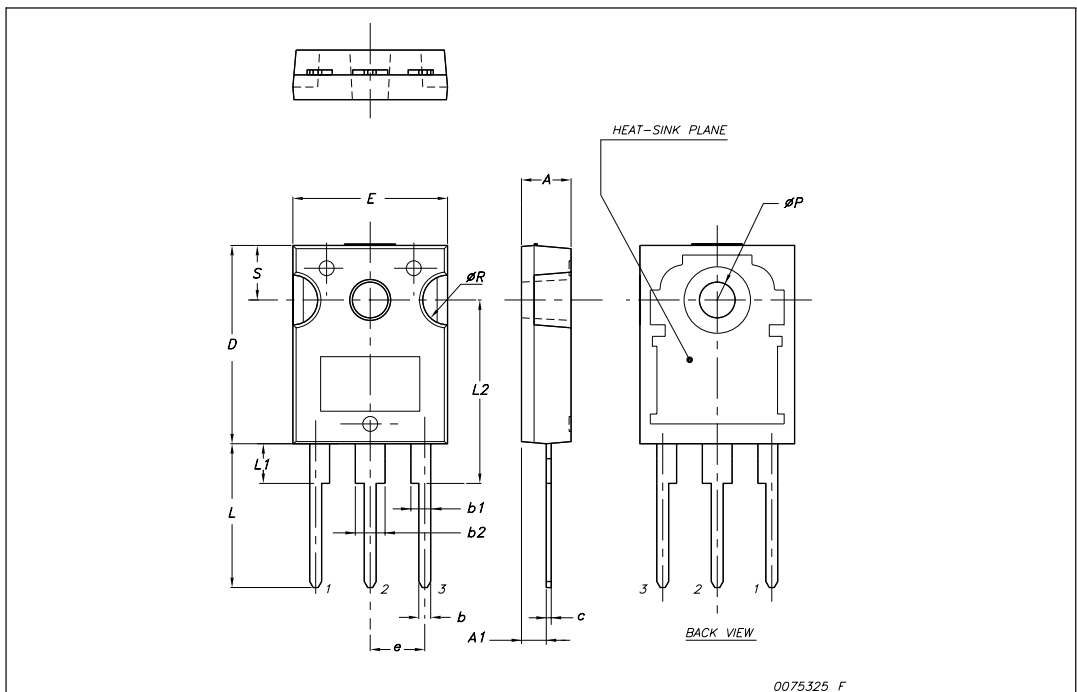

## 5 Revision history

**Table 9. Document revision history**

Date	Revision	Changes
17-Nov-2005	1	First release
05-May-2006	2	Inserted curves
10-Jul-2006	3	Modified value on <i>Absolute maximum ratings</i>
01-Dec-2006	4	Modified value on <i>Dynamic</i>
16-May-2007	5	New curves updated: <i>Figure 5</i> and <i>Figure 6</i>
22-Aug-2007	6	Added new <i>Figure 17</i> and new section <i>2.2: Frequency applications</i>
31-Jan-2008	7	Modified: <i>Table 8: Collector-emitter diode</i>
29-Jul-2008	8	Updated $V_{CE(sat)}$ on <i>Table 4</i>

**Please Read Carefully:**

Information in this document is provided solely in connection with ST products. STMicroelectronics NV and its subsidiaries ("ST") reserve the right to make changes, corrections, modifications or improvements, to this document, and the products and services described herein at any time, without notice.

All ST products are sold pursuant to ST's terms and conditions of sale.

Purchasers are solely responsible for the choice, selection and use of the ST products and services described herein, and ST assumes no liability whatsoever relating to the choice, selection or use of the ST products and services described herein.

No license, express or implied, by estoppel or otherwise, to any intellectual property rights is granted under this document. If any part of this document refers to any third party products or services it shall not be deemed a license grant by ST for the use of such third party products or services, or any intellectual property contained therein or considered as a warranty covering the use in any manner whatsoever of such third party products or services or any intellectual property contained therein.

**UNLESS OTHERWISE SET FORTH IN ST'S TERMS AND CONDITIONS OF SALE ST DISCLAIMS ANY EXPRESS OR IMPLIED WARRANTY WITH RESPECT TO THE USE AND/OR SALE OF ST PRODUCTS INCLUDING WITHOUT LIMITATION IMPLIED WARRANTIES OF MERCHANTABILITY, FITNESS FOR A PARTICULAR PURPOSE (AND THEIR EQUIVALENTS UNDER THE LAWS OF ANY JURISDICTION), OR INFRINGEMENT OF ANY PATENT, COPYRIGHT OR OTHER INTELLECTUAL PROPERTY RIGHT.**

**UNLESS EXPRESSLY APPROVED IN WRITING BY AN AUTHORIZED ST REPRESENTATIVE, ST PRODUCTS ARE NOT RECOMMENDED, AUTHORIZED OR WARRANTED FOR USE IN MILITARY, AIR CRAFT, SPACE, LIFE SAVING, OR LIFE SUSTAINING APPLICATIONS, NOR IN PRODUCTS OR SYSTEMS WHERE FAILURE OR MALFUNCTION MAY RESULT IN PERSONAL INJURY, DEATH, OR SEVERE PROPERTY OR ENVIRONMENTAL DAMAGE. ST PRODUCTS WHICH ARE NOT SPECIFIED AS "AUTOMOTIVE GRADE" MAY ONLY BE USED IN AUTOMOTIVE APPLICATIONS AT USER'S OWN RISK.**

Resale of ST products with provisions different from the statements and/or technical features set forth in this document shall immediately void any warranty granted by ST for the ST product or service described herein and shall not create or extend in any manner whatsoever, any liability of ST.

ST and the ST logo are trademarks or registered trademarks of ST in various countries.

Information in this document supersedes and replaces all information previously supplied.

The ST logo is a registered trademark of STMicroelectronics. All other names are the property of their respective owners.

© 2008 STMicroelectronics - All rights reserved

STMicroelectronics group of companies

Australia - Belgium - Brazil - Canada - China - Czech Republic - Finland - France - Germany - Hong Kong - India - Israel - Italy - Japan - Malaysia - Malta - Morocco - Singapore - Spain - Sweden - Switzerland - United Kingdom - United States of America

[www.st.com](http://www.st.com)

# Mouser Electronics

Authorized Distributor

Click to View Pricing, Inventory, Delivery & Lifecycle Information:

[STMicroelectronics:](#)

[STGW39NC60VD](#)