

## Low Dropout Voltage Regulator with Reset

### ■ GENERAL DISCRIPTION

The NJM2805 is a low dropout voltage regulator with reset function.

It provides up to 300mA of logic supply, and the reset function monitors output voltage of the regulator with 1% accuracy.

It is suitable for local power supply and reset for small micro controller and other logic chips.

### ■ FEATURES

- Output Voltage Accuracy  $V_o \pm 1.0\%$
- Reset Voltage Accuracy  $V_{RT} \pm 1.0\%$
- Adjust reset delay time with external capacitor.
- Ripple Rejection 75dB typ. (f = 1kHz)
- Output Voltage Monitor type
- Open Collector Output
- Internal Short Circuit Current Limit
- Internal Thermal Overload Protection
- Bipolar Technology
- Package Outline SOT-89 -5

### ■ PACKAGE OUTLINE

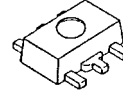

NJM2805U1

### ■ PIN CONFIGURATION

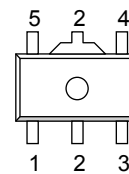

NJM2805U1

### PIN FUNCTION

1.  $V_{OUT}$
2. GND
3. Cd
4.  $V_{OR}$
5.  $V_{IN}$

### ■ OUTPUT VOLTAGE/ DETECTION VOLTAGE

Device Name	$V_{OUT}$	$V_{DET}$
NJM2805U1-2923	2.9V	2.3V
NJM2805U1-3329	3.3V	2.9V
NJM2805U1-0543	5.0V	4.3V

### ■ EQUIVALENT CIRCUIT

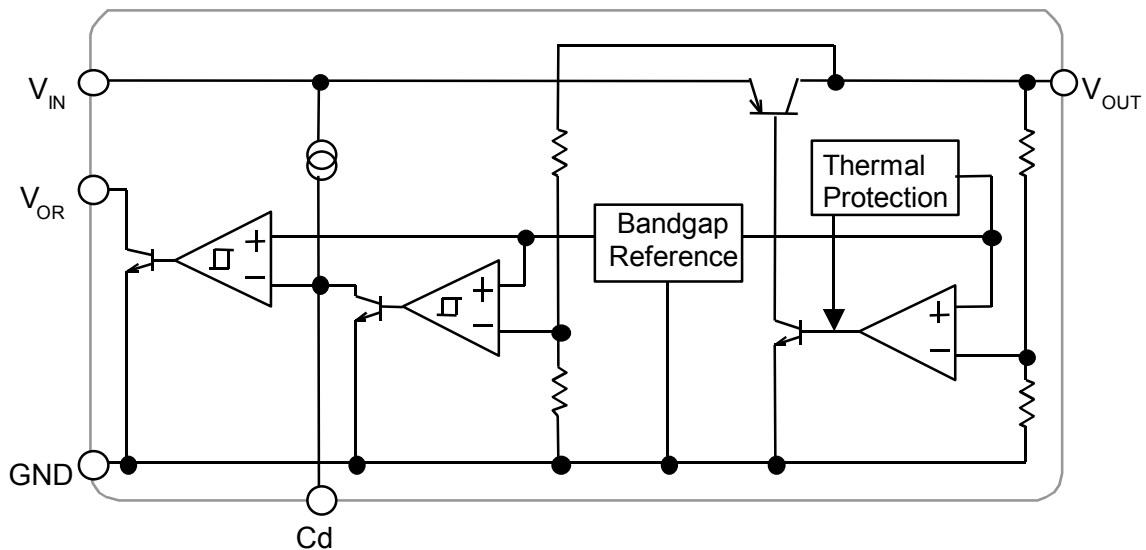

# NJM2805

## ■ ABSOLUTE MAXIMUM RATINGS

(Ta=25°C)

PARAMETER	SYMBOL	RATINGS	UNIT
Input Voltage	V <sub>IN</sub>	+14	V
Power Dissipation	P <sub>D</sub>	350	mW
Operating Temperature	Topr	-40 ~ +85	°C
Storage Temperature	Tstg	-40 ~ +125	°C

## ■ ELECTRICAL CHARACTERISTICS

(V<sub>IN</sub>=V<sub>o</sub>+1V, C<sub>IN</sub>=0.1μF, C<sub>o</sub>=1μF (C<sub>o</sub>=2.2μF: V<sub>o</sub>≤2.6V) Ta=25°C)

PARAMETER	SYMBOL	TEST CONDITION	MIN.	TYP.	MAX.	UNIT
Quiescent Current	I <sub>Q</sub>	I <sub>o</sub> =0mA	–	250	350	μA
Regulator Block						
Output Voltage	V <sub>o</sub>	I <sub>o</sub> =30mA	-1.0%	–	+1.0%	V
Output Current	I <sub>o</sub>	V <sub>o</sub> =0.3V	300	400	–	mA
Line Regulation	ΔV <sub>o</sub> /ΔV <sub>IN</sub>	V <sub>IN</sub> =V <sub>o</sub> +1V ~ V <sub>o</sub> +6V, I <sub>o</sub> =30mA	–	–	0.10	%/V
Load Regulation	ΔV <sub>o</sub> /ΔI <sub>o</sub>	I <sub>o</sub> =0 ~ 300mA	–	–	0.03	%/mA
Dropout Voltage	ΔV <sub>L<sub>O</sub></sub>	I <sub>o</sub> =100mA	–	0.10	0.18	V
Ripple Rejection	RR	e <sub>in</sub> =200mVrms, f=1kHz, I <sub>o</sub> =10mA, V <sub>o</sub> =3V Version	–	75	–	dB
Output Voltage Temperature Coefficient	ΔV <sub>o</sub> /ΔT	Ta=0 ~ 85°C, I <sub>o</sub> =10mA	–	±50	–	ppm/°C
Output Noise Voltage	V <sub>NO</sub>	f=10Hz ~ 80kHz, I <sub>o</sub> =10mA, V <sub>o</sub> =3V Version	–	45	–	μVrms
Reset Block						
Voltage Detection	V <sub>RT</sub>	V <sub>IN</sub> =H→L	-1.0%	–	+1.0%	V
Hysteresis Voltage	V <sub>RTH</sub>	V <sub>IN</sub> =H→L→H	V <sub>RT</sub> ×3%	V <sub>RT</sub> ×5%	V <sub>RT</sub> ×8%	V
Low Level Output Voltage	R <sub>ORL</sub>	V <sub>IN</sub> =V <sub>RT</sub> -0.5V, R <sub>L</sub> =100kΩ	–	100	300	mV
Output Leak Current	I <sub>ORH</sub>	V <sub>IN</sub> =V <sub>RT</sub> +0.5V	–	–	0.1	μA
On time Output Current	I <sub>ORL</sub>	V <sub>IN</sub> =V <sub>RT</sub> -0.5V, R <sub>L</sub> =0Ω	5	–	–	mA
Reset Output Delay Time	t <sub>d</sub>	V <sub>IN</sub> =(V <sub>RT</sub> -0.5V)→(V <sub>RT</sub> +0.5V), C <sub>d</sub> =0.1μF	9	10	11	ms
Operation Voltage Limit	V <sub>OPL</sub>	V <sub>ORL</sub> =0.4V	–	0.9	–	V

The above specification is a common specification for all output voltages.

Therefore, it may be different from the individual specification for a specific output voltage.

## ■ TIMING CHART

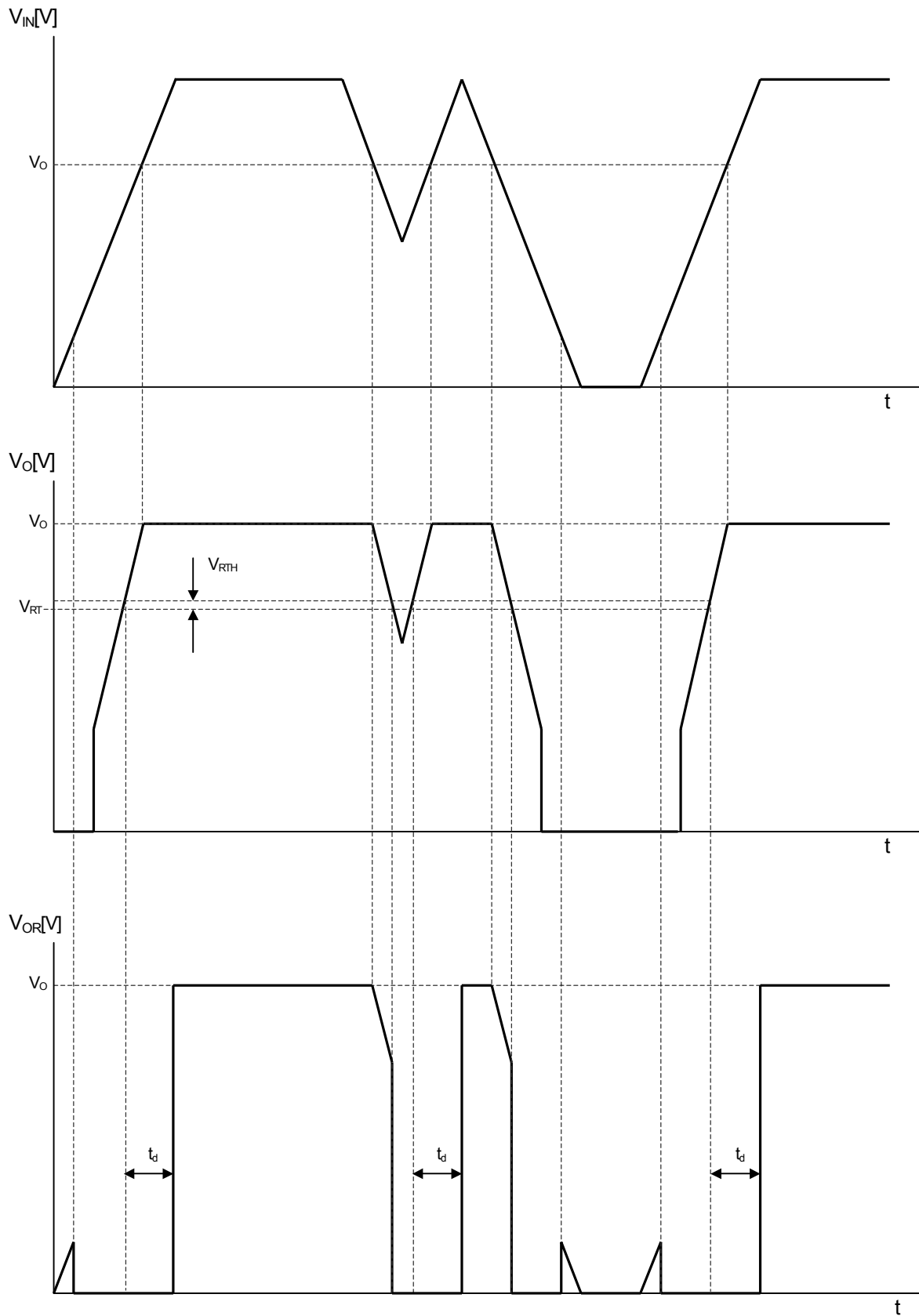

\* When the pull-up of the  $V_{OR}$  is carried out to  $V_{IN}$  through resistance.

# NJM2805

## TEST CIRCUIT

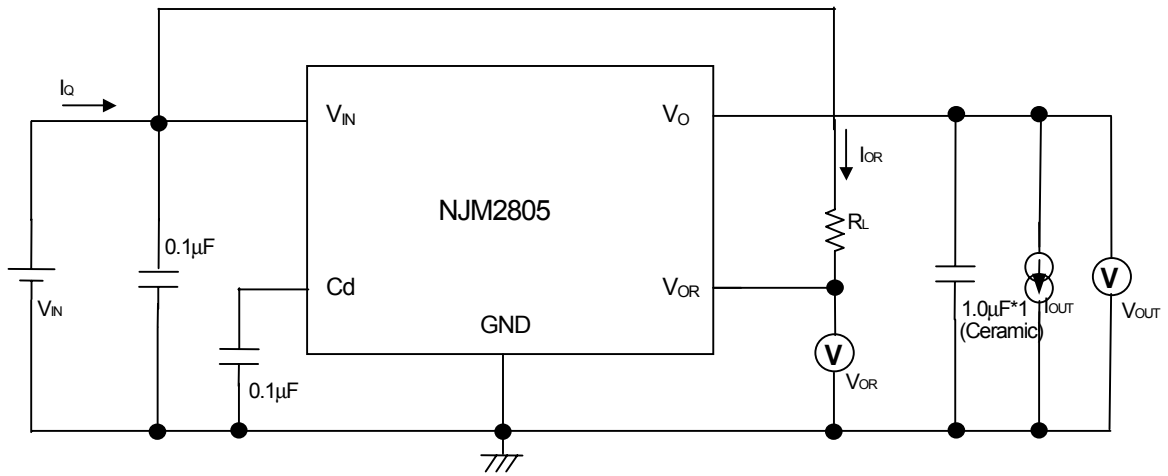

\*1  $V_{OS} \leq 2.6\text{V}$ ;  $C_o = 2.2\mu\text{F}$  (Ceramic)

## TYPICAL APPLICATIONS

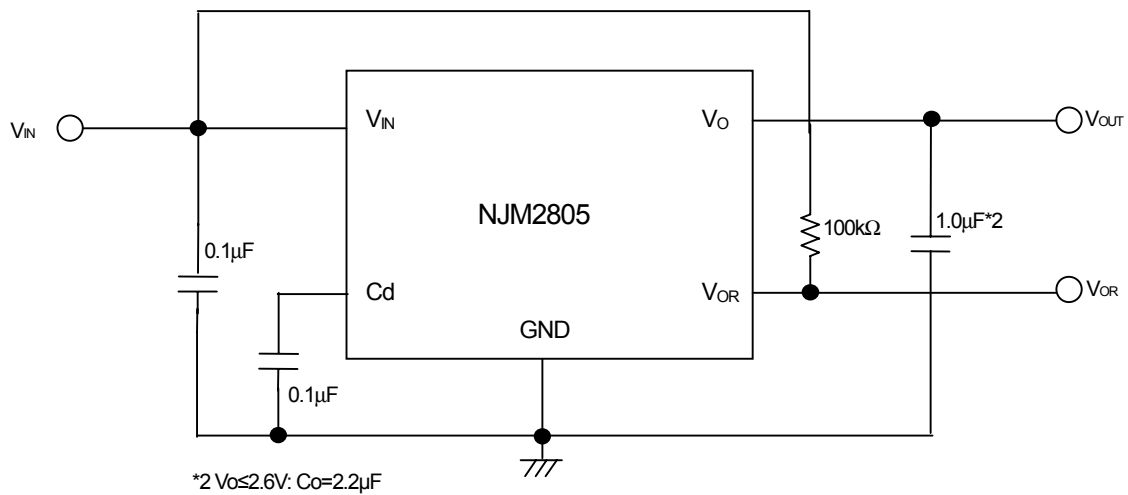

\*2  $V_{OS} \leq 2.6\text{V}$ ;  $C_o = 2.2\mu\text{F}$

## ■ ELECTRICAL CHARISTICS

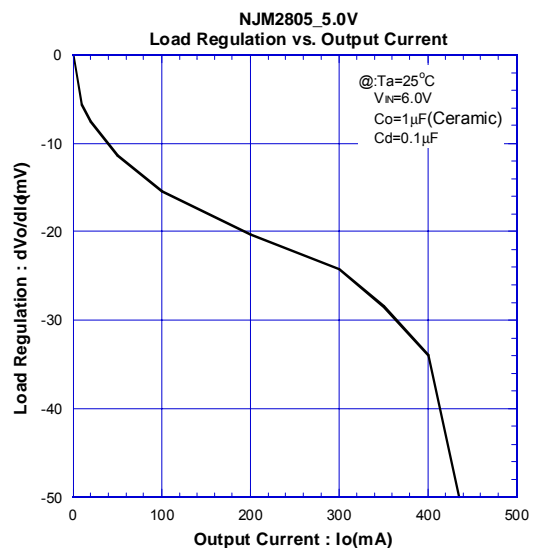
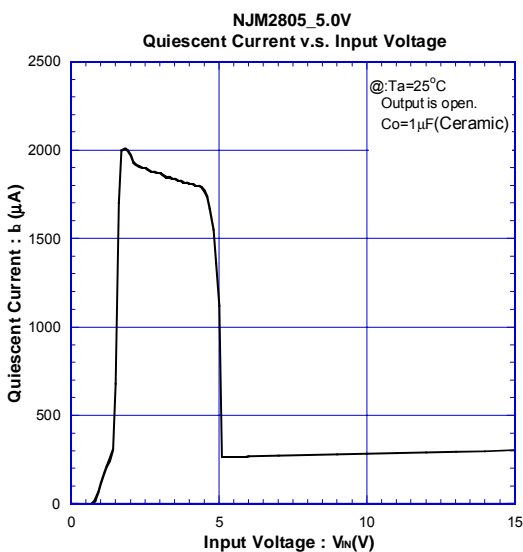
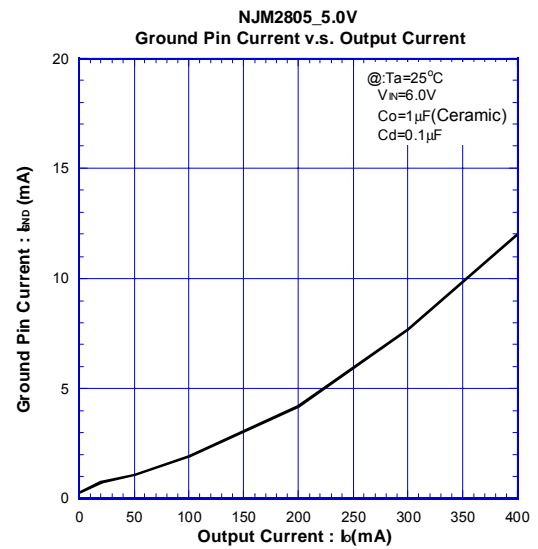
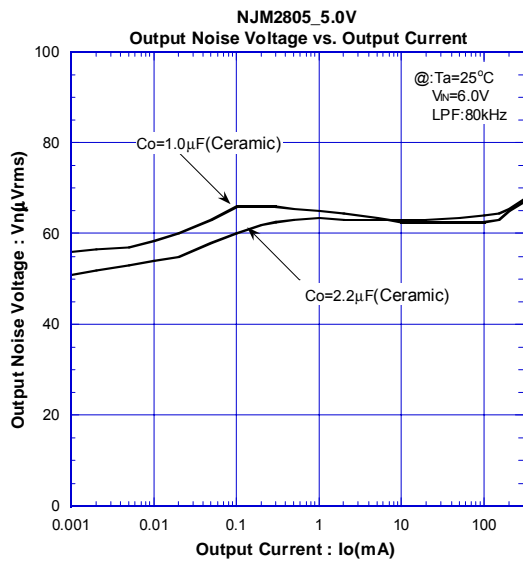
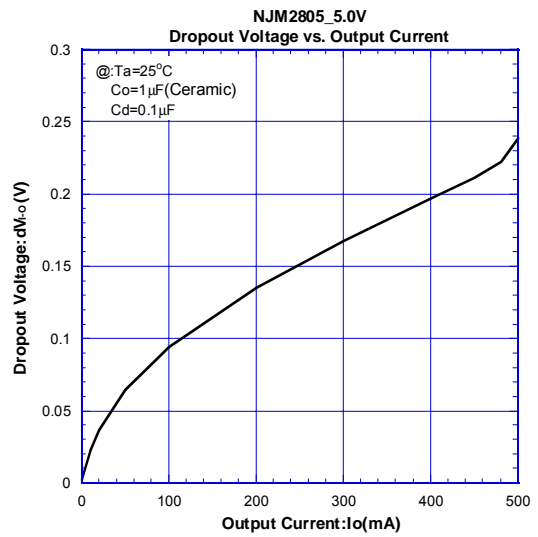
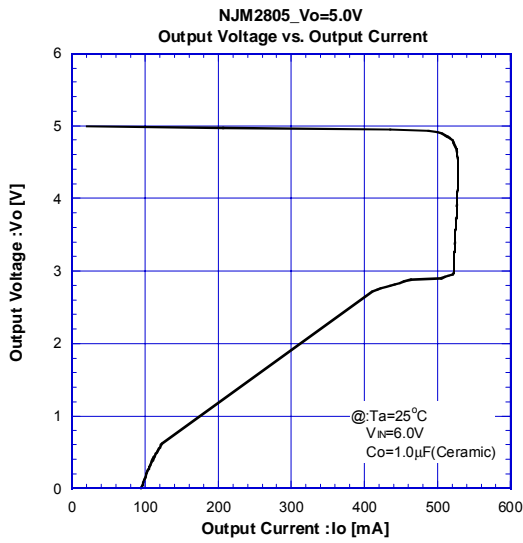

# NJM2805

## ELECTRICAL CHARACTERISTICS

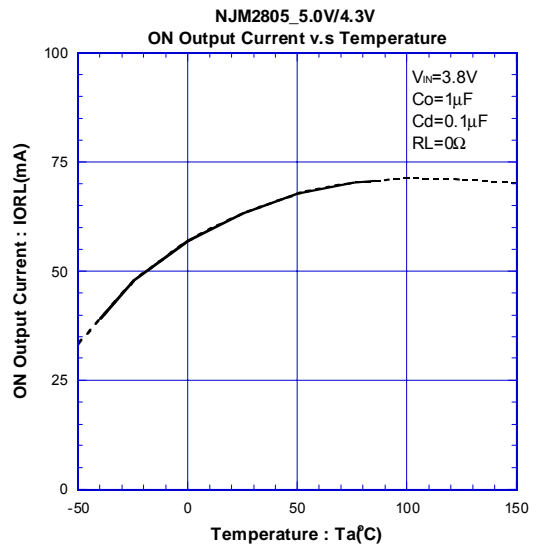
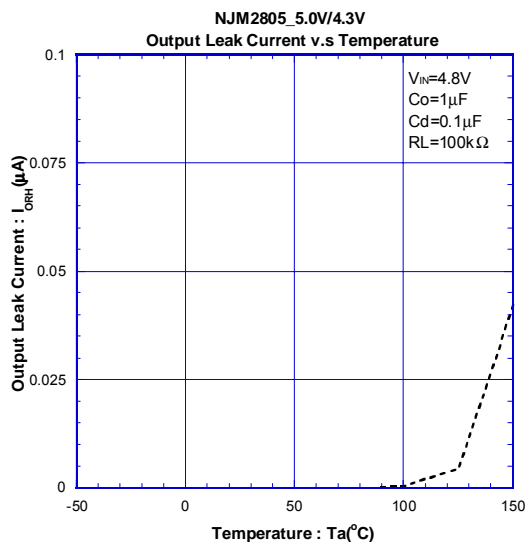
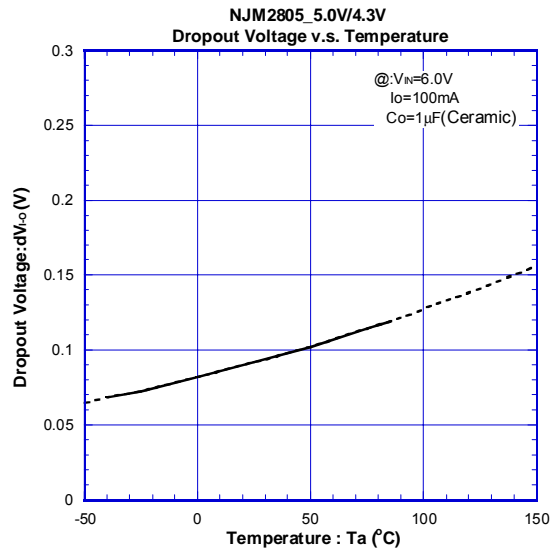
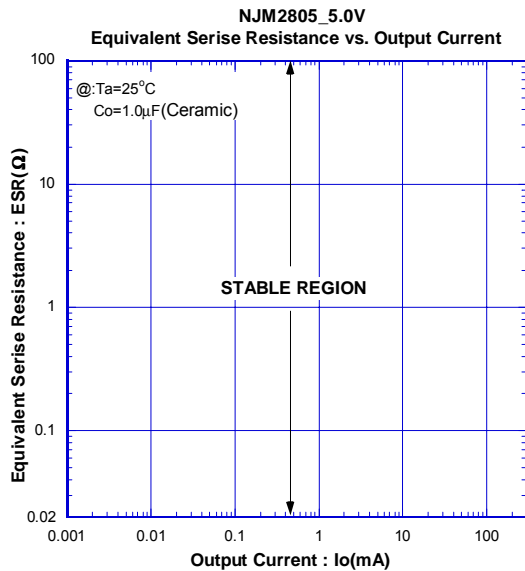
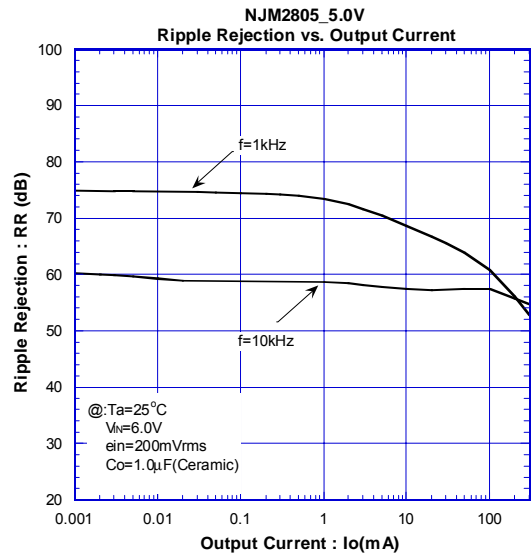
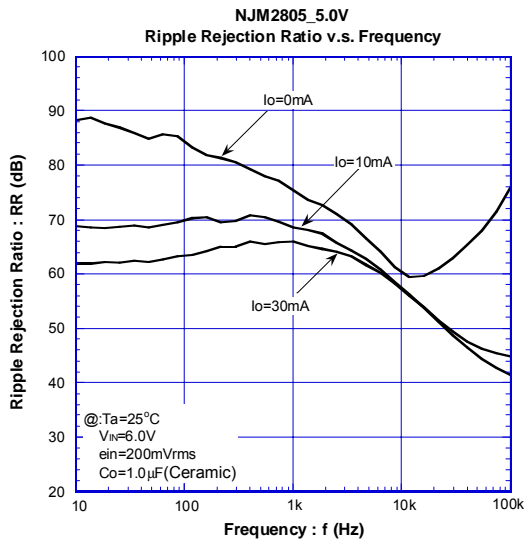

## ■ ELECTRICAL CHARACTERISTICS

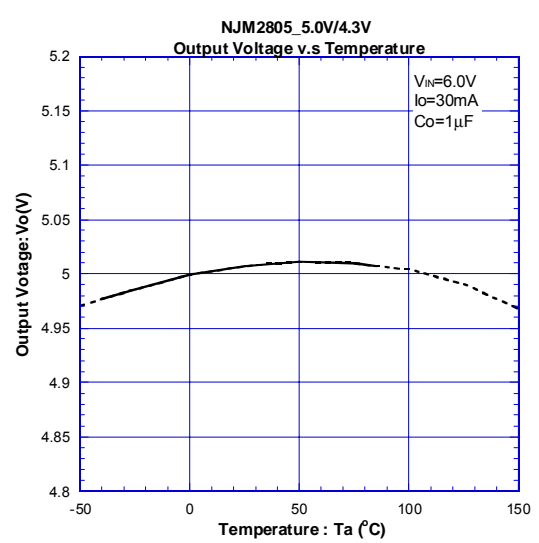
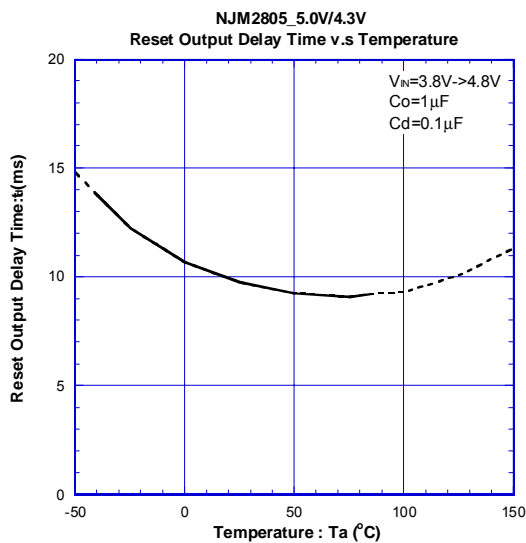
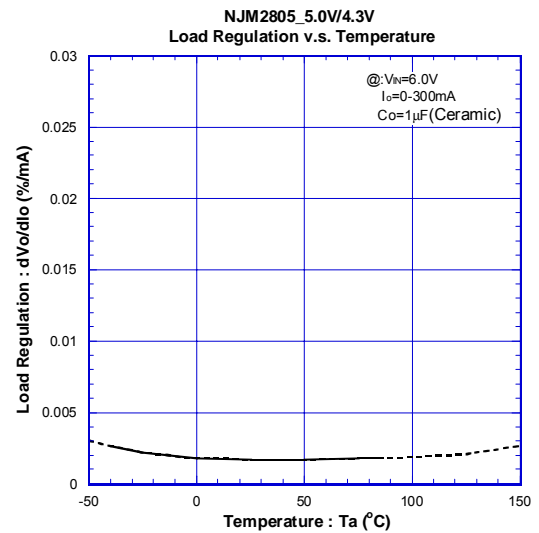
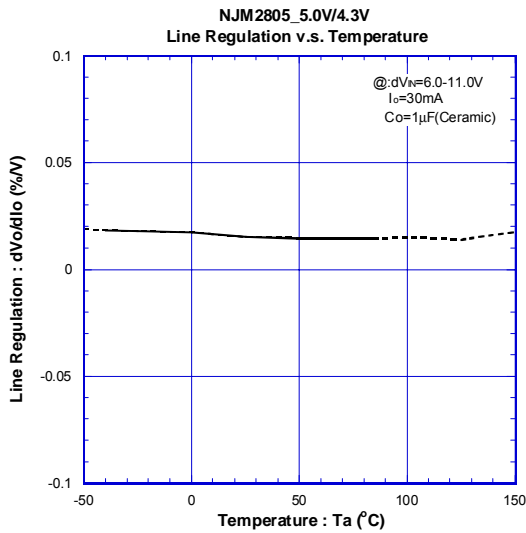
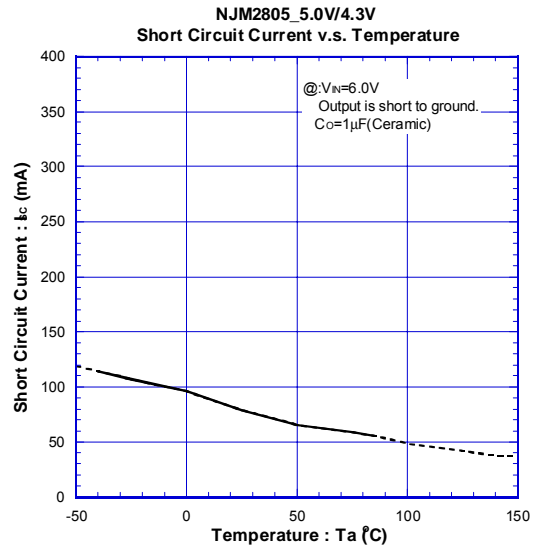
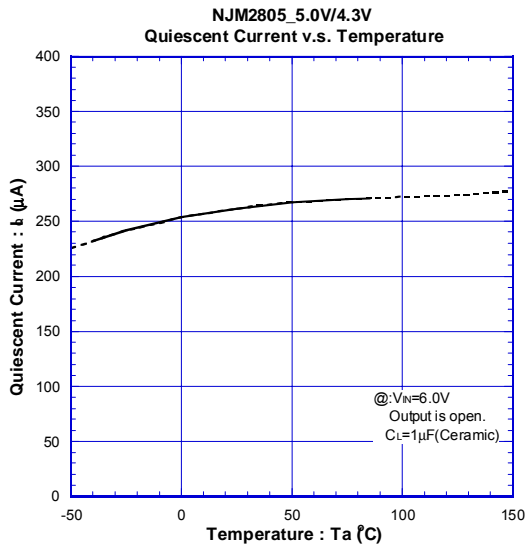

# NJM2805

## ELECTRICAL CHARISTICS

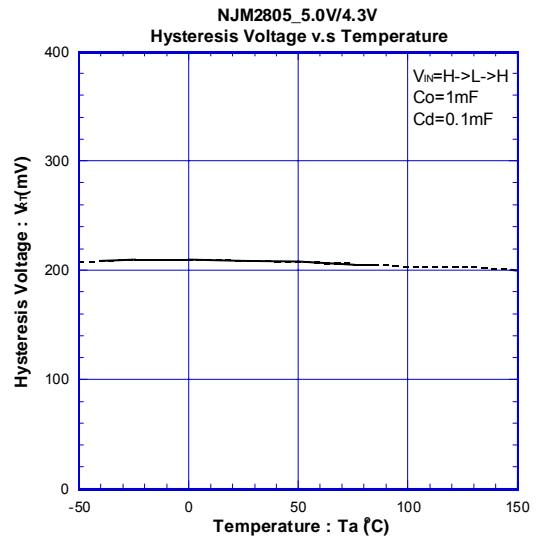
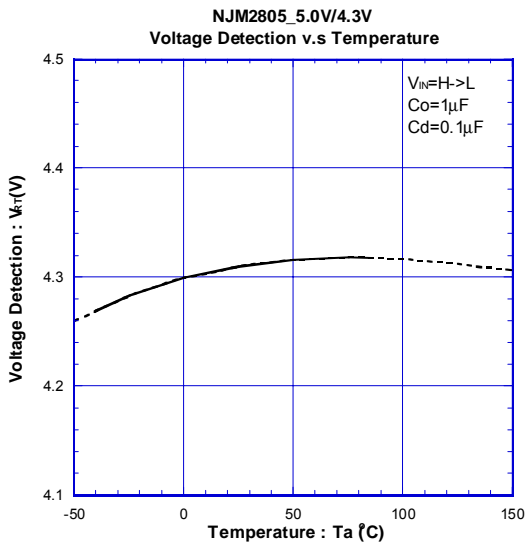
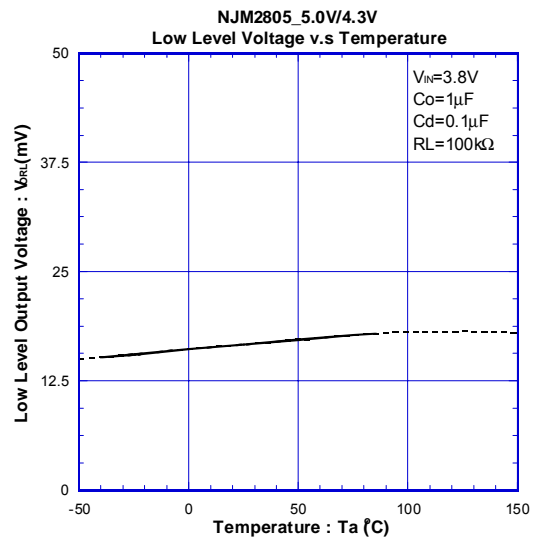
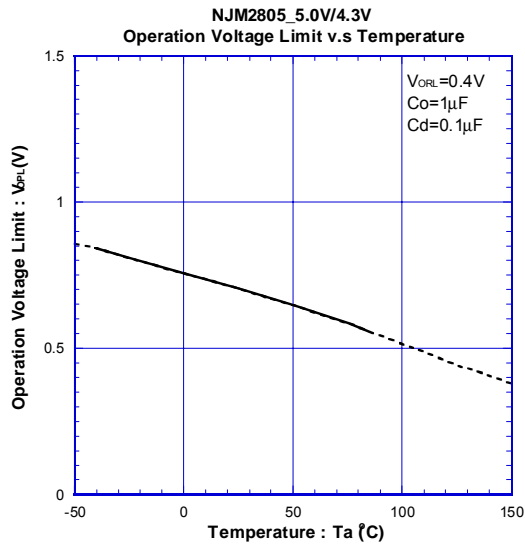



**[CAUTION]**

The specifications on this databook are only given for information, without any guarantee as regards either mistakes or omissions. The application circuits in this databook are described only to show representative usages of the product and not intended for the guarantee or permission of any right including the industrial rights.

# Mouser Electronics

Authorized Distributor

Click to View Pricing, Inventory, Delivery & Lifecycle Information:

[NJR:](#)

[NJM2805U1-TE1](#) [NJM2805U1-2923-TE1](#) [NJM2805U1-3329-TE1](#) [NJM2805U1-0543-TE1](#)