

TV-10/TV-15 rated 1a 30A, 2a 20A power relays

HE RELAYS



1 Form A Plug-in type

RoHS compliant

FEATURES

1. Excellent resistance to contact welding

Owing to the pre-tension and kick-off mechanism, the 1 Form A passes TV-15 and the 2 Form A passes TV-10.

2. High-capacity and long life

| | | |
|-------------------------------------|---|---------------|
| Contact arrangement | 1 Form A type | 2 Form A type |
| Contact capacity | 30A | 20A |
| Electrical life (at 20 times/min.) | 2×10 ⁵ | |
| Mechanical life (at 180 times/min.) | DC type: 10 ⁷ , AC type: 5×10 ⁶ | |

3. Excellent surge resistance

Between contacts and coil, the surge voltage is more than 10,000 V (when surge waveform accords with JEC-212-1981).

4. Compatible with all major safety standards

UL, CSA, VDE and TÜV certified

5. Terminals are available

TYPICAL APPLICATIONS

1. Office equipment

Copiers, package air conditioners, automatic vending machines.

2. Industrial equipment

Machine tools, molding equipment, wrapping machines, food processing equipment, etc.

3. Home appliances

Air conditioners, microwave ovens, televisions, stereo systems, water heaters and air heating equipment.

| | | |
|----------------------------|-------------------------------------|-------------------------------|
| Type | Single side stable type | |
| | HE 1 Form A, 2 Form A | |
| Insulation gap | Min. 8 mm | |
| Distance between contacts* | 1 Form A and 2 Form A: Min. 3 mm | PC board type: Min. 2.5 mm |
| Breakdown voltage | Between open contacts | 2, 000 Vrms for 1 min. |
| | Between contact and coil | 5, 000 Vrms for 1 min. |

* Reference value

CLASSIFICATION

| Type | PC board | Plug-in | | TM | | Screw terminal | |
|---------------------|--------------------|----------|----------|----------|----------|----------------|----------|
| Operating function | Single side stable | | | | | | |
| Contact arrangement | 1 Form A | 1 Form A | 2 Form A | 1 Form A | 2 Form A | 1 Form A | 2 Form A |

ORDERING INFORMATION



HE

TYPES

1. PC board type (1 Form A, DC coil) (Single side stable)

| Nominal coil voltage | 1 Form A | |
|----------------------|----------------|--|
| | Part No. | |
| 6V DC | HE1aN-P-DC6V | |
| 12V DC | HE1aN-P-DC12V | |
| 24V DC | HE1aN-P-DC24V | |
| 48V DC | HE1aN-P-DC48V | |
| 100V DC | HE1aN-P-DC100V | |
| 110V DC | HE1aN-P-DC110V | |

Standard packing: Carton: 25 pcs.; Case: 100 pcs.

2. Plug-in type (Single side stable)

| Type | Nominal coil voltage | 1 Form A | | 2 Form A | |
|---------|----------------------|--------------|--|--------------|--|
| | | Part No. | | Part No. | |
| DC type | 6V DC | HE1aN-DC6V | | HE2aN-DC6V | |
| | 12V DC | HE1aN-DC12V | | HE2aN-DC12V | |
| | 24V DC | HE1aN-DC24V | | HE2aN-DC24V | |
| | 48V DC | HE1aN-DC48V | | HE2aN-DC48V | |
| | 100V DC | HE1aN-DC100V | | HE2aN-DC100V | |
| | 110V DC | HE1aN-DC110V | | HE2aN-DC110V | |
| AC type | 12V AC | HE1aN-AC12V | | HE2aN-AC12V | |
| | 24V AC | HE1aN-AC24V | | HE2aN-AC24V | |
| | 48V AC | HE1aN-AC48V | | HE2aN-AC48V | |
| | 100/120V AC | HE1aN-AC100V | | HE2aN-AC100V | |
| | 200/240V AC | HE1aN-AC200V | | HE2aN-AC200V | |

Standard packing: Carton: 20 pcs.; Case: 100 pcs.

3. TM type (Single side stable)

| Type | Nominal coil voltage | 1 Form A | | 2 Form A | |
|---------|----------------------|----------------|--|----------------|--|
| | | Part No. | | Part No. | |
| DC type | 6V DC | HE1aN-Q-DC6V | | HE2aN-Q-DC6V | |
| | 12V DC | HE1aN-Q-DC12V | | HE2aN-Q-DC12V | |
| | 24V DC | HE1aN-Q-DC24V | | HE2aN-Q-DC24V | |
| | 48V DC | HE1aN-Q-DC48V | | HE2aN-Q-DC48V | |
| | 100V DC | HE1aN-Q-DC100V | | HE2aN-Q-DC100V | |
| | 110V DC | HE1aN-Q-DC110V | | HE2aN-Q-DC110V | |
| AC type | 12V AC | HE1aN-Q-AC12V | | HE2aN-Q-AC12V | |
| | 24V AC | HE1aN-Q-AC24V | | HE2aN-Q-AC24V | |
| | 48V AC | HE1aN-Q-AC48V | | HE2aN-Q-AC48V | |
| | 100/120V AC | HE1aN-Q-AC100V | | HE2aN-Q-AC100V | |
| | 200/240V AC | HE1aN-Q-AC200V | | HE2aN-Q-AC200V | |

Standard packing: Carton: 20 pcs.; Case: 100 pcs.

4. Screw terminal type (Single side stable)

| Type | Nominal coil voltage | 1 Form A | | 2 Form A | |
|---------|----------------------|----------------|--|----------------|--|
| | | Part No. | | Part No. | |
| DC type | 6V DC | HE1aN-S-DC6V | | HE2aN-S-DC6V | |
| | 12V DC | HE1aN-S-DC12V | | HE2aN-S-DC12V | |
| | 24V DC | HE1aN-S-DC24V | | HE2aN-S-DC24V | |
| | 48V DC | HE1aN-S-DC48V | | HE2aN-S-DC48V | |
| | 100V DC | HE1aN-S-DC100V | | HE2aN-S-DC100V | |
| | 110V DC | HE1aN-S-DC110V | | HE2aN-S-DC110V | |
| AC type | 12V AC | HE1aN-S-AC12V | | HE2aN-S-AC12V | |
| | 24V AC | HE1aN-S-AC24V | | HE2aN-S-AC24V | |
| | 48V AC | HE1aN-S-AC48V | | HE2aN-S-AC48V | |
| | 100/120V AC | HE1aN-S-AC100V | | HE2aN-S-AC100V | |
| | 200/240V AC | HE1aN-S-AC200V | | HE2aN-S-AC200V | |

Standard packing: Carton: 10 pcs.; Case: 50 pcs.

Note: The TM type of the screw terminals are also available.

* For terminal sockets, see page 198.

RATING

1. Coil data

1) AC coils

| Nominal coil voltage | Pick-up voltage (at 20°C 68°F) | Drop-out voltage (at 20°C 68°F) | Nominal operating current [±10%] (at 20°C 68°F) | Nominal operating power | Max. applied voltage (at 20°C 68°F) |
|----------------------|---|---|--|-------------------------|--|
| 12V AC | 70%V or less of nominal voltage (Initial) | 15%V or more of nominal voltage (Initial) | 138mA | 1.7VA | 110%V of nominal voltage |
| 24V AC | | | 74mA | 1.8VA | |
| 48V AC | | | 39mA | 1.9VA | |
| 100/120V AC | | | 18.7 to 2.1mA | 1.9 to 2.7VA | |
| 200/240V AC | | | 9.1 to 10.8mA | 1.8 to 2.6VA | |

2) DC coils

| Nominal coil voltage | Pick-up voltage (at 20°C 68°F) | Drop-out voltage (at 20°C 68°F) | Nominal operating current [±10%] (at 20°C 68°F) | Coil resistance [±10%] (at 20°C 68°F) | Nominal operating power | Max. applied voltage (at 55°C 131°F) |
|----------------------|---|---|---|--|----------------------------|---|
| 6V DC | 70%V or less of nominal voltage (Initial) | 10%V or more of nominal voltage (Initial) | 320mA | 18.8Ω | 1.92W | 110%V of nominal voltage |
| 12V DC | | | 160mA | 75Ω | 1.92W | |
| 24V DC | | | 80mA | 300Ω | 1.92W | |
| 48V DC | | | 40mA | 1,200Ω | 1.92W | |
| 100V DC | | | 19mA | 5,200Ω | 1.92W | |
| 110V DC | | | 18mA | 6,300Ω | 1.92W | |

2. Specifications

| Characteristics | Item | Specifications | |
|----------------------------|---|--|---|
| Contact | Contact material | AgSnO ₂ type | |
| | Arrangement | 1 Form A 2 Form A | |
| | Contact resistance (Initial) | Max. 100 mΩ (By voltage drop 6 V DC 1A) | |
| Rating | Nominal switching capacity (resistive load) | 30A 277V AC 25A 277V AC | |
| | Max. switching power | 8,310VA 6,925VA | |
| | Max. switching voltage | 277V AC, 30V DC | |
| | Max. switching current | 30A 25A | |
| | Nominal operating power | DC: 1.92W, AC: 1.7 to 2.7VA | |
| | Min. switching capacity (Reference value)*1 | 100mA 5V DC | |
| Electrical characteristics | Insulation resistance (Initial) | Min. 1,000MΩ (at 500V DC) Measurement at same location as "Breakdown voltage" section. | |
| | Breakdown voltage (Initial) | Between open contacts | 2,000 Vrms for 1min (Detection current: 10mA.) |
| | | Between contact sets | — 4,000 Vrms for 1min (Detection current: 10mA.) |
| | | Between contact and coil | 5,000 Vrms for 1min (Detection current: 10mA.) |
| | Temperature rise (coil) | DC: Max. 60°C (at 55°C) (By resistive method), AC: Max. 65°C (at 55°C) (By resistive method) | |
| | Surge breakdown voltage*2 (between contact and coil) (Initial) | Min. 10,000V | |
| Mechanical characteristics | Shock resistance | Functional | Min. 98 m/s ² (Half-wave pulse of sine wave: 11 ms; detection time: 10μs.) |
| | | Destructive | Min. 980 m/s ² (Half-wave pulse of sine wave: 6 ms.) |
| | Vibration resistance | Functional | 10 to 55 Hz at double amplitude of 1 mm (Detection time: 10μs.) |
| | | Destructive | 10 to 55 Hz at double amplitude of 1.5 mm |
| Expected life | Mechanical | DC: Min. 10 ⁷ (at 180 times/min.), AC: Min. 5×10 ⁶ (at 180 times/min.) | |
| | Electrical (resistive load) (at 20 times/min.) | Min. 10 ⁵ (30A 277V AC) Min. 10 ⁵ (25A 277V AC) Min. 2×10 ⁵ (30A 250V AC) Min. 2×10 ⁵ (20A 250V AC) | |
| Conditions | Conditions for operation, transport and storage*3 | Ambient temperature: -50°C to +55°C -58°F to +131°F Humidity: 5 to 85% R.H. (Not freezing and condensing at low temperature), Air pressure: 86 to 106kPa | |
| | Max. operating speed | 20 times/min. (at max. rating) | |
| Unit weight | | PC board type: approx. 80g 2.82oz, Plug-in type/TM type: approx. 90g 3.17oz, Screw terminal type: approx. 120g 4.23oz | |

Notes: *1. This value can change due to the switching frequency, environmental conditions, and desired reliability level, therefore it is recommended to check this with the actual load.

*2. Wave is standard shock voltage of ±1.2×50μs according to JEC-212-1981

*3. The upper limit of the ambient temperature is the maximum temperature that can satisfy the coil temperature rise value. Refer to Usage, transport and storage conditions in NOTES.

REFERENCE DATA

1 Form A Type

1. Maximum switching power



2. Life curve



3. Coil temperature rise (DC type)

Measured portion: Inside the coil
Contact current: 30 A



4. Ambient temperature characteristics

Tested sample: HE1aN-AC120V, 6 pcs.



2 Form A Type

1. Maximum switching power



2. Life curve



3. Coil temperature rise (DC type)

Measured portion: Inside the coil
Contact current: 30 A



4. Ambient temperature characteristics

Tested sample: HE2aN-AC120V, 6 pcs.



DIMENSIONS (mm inch)

The CAD data of the products with a **CAD Data** mark can be downloaded from: <http://industrial.panasonic.com/ac/e/>

1. PC board type

1 Form A

CAD Data

External dimensions
Single side stable type



General tolerance: $\pm 0.3 \pm 0.012$

Schematic (Bottom view)
Single side stable type

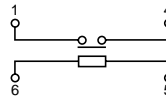

PC board pattern (Bottom view)



Tolerance: $\pm 0.1 \pm 0.004$

2. Plug-in type

1 Form A

CAD Data

External dimensions
Single side stable type



General tolerance: $\pm 0.3 \pm 0.012$

Schematic (Bottom view)
Single side stable type



Panel cutout



Tolerance: $\pm 0.1 \pm 0.004$

2 Form A

CAD Data

External dimensions
Single side stable type



General tolerance: $\pm 0.3 \pm 0.012$

Schematic (Bottom view)
Single side stable type



Panel cutout

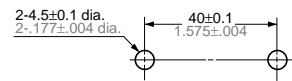

Tolerance: $\pm 0.1 \pm 0.004$

3. TM type

CAD Data

External dimensions Single side stable type

1 Form A

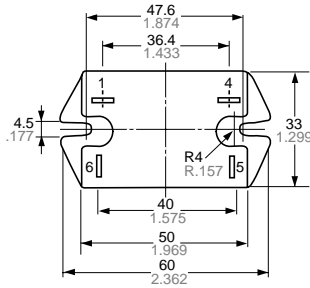

2 Form A

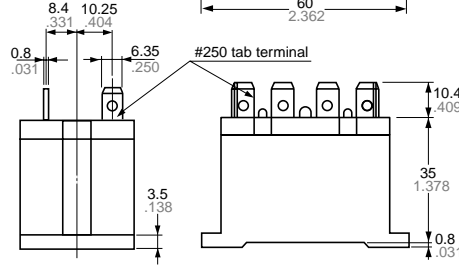
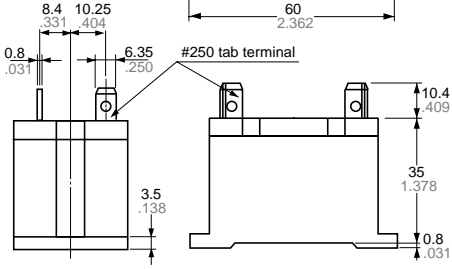
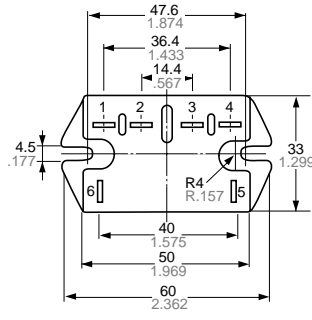

General tolerance: $\pm 0.3 \pm 0.012$

Schematic (Bottom view) Single side stable type

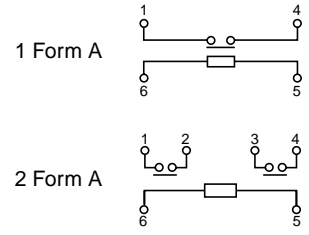

Panel cutout

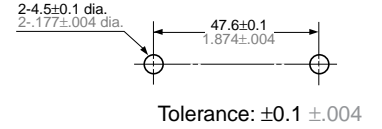

4. Screw terminal type

1 Form A

CAD Data

External dimensions Single side stable type

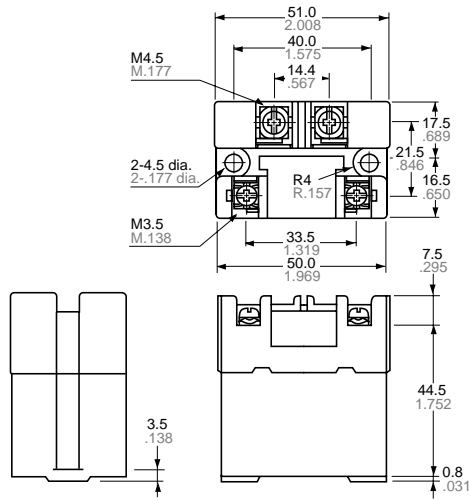

General tolerance: $\pm 0.3 \pm 0.012$

Schematic (Bottom view) Single side stable type

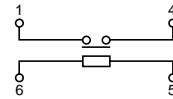

Panel cutout

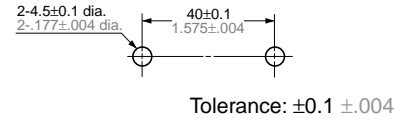

2 Form A

CAD Data

External dimensions
Single side stable type



General tolerance: $\pm 0.3 \pm 0.12$

Schematic (Bottom view)
Single side stable type



Panel cutout



Tolerance: $\pm 0.1 \pm 0.04$

MOUNTING METHOD

1. Plug-in type



2. Screw terminal type



3. Allowable installation wiring size for screw terminal types and terminal sockets

Due to the UP terminals, it is possible to either directly connect the wires or use crimped terminal.

SAFETY STANDARDS

| Item | UL/C-UL (Recognized) | | CSA (Certified) | | VDE (Certified) | | TV rating (UL/CSA) | | TÜV (Certified) | |
|----------|----------------------|---|-----------------|---|-----------------|--|--------------------|--------|----------------------|--|
| | File No. | Contact rating | File No. | Contact rating | File No. | Contact rating | File No. | Rating | File No. | Rating |
| 1 Form A | E43028 | 30A 277V AC 30A 30V DC 1.5HP 125V AC 3HP 250V AC | LR26550 etc. | 30A 277V AC 30A 30V DC 1.5HP 125V AC 3HP 250V AC | 40006681 | 30A 250V AC (cosφ=1.0) 30A 250V AC (cosφ=0.4) 5A 110V DC (0ms) | UL E43028 | TV-15 | B 11 04 13461 293 | 30A 250V AC (cosφ=1.0) 30A 250V AC (cosφ=0.4) 8A 110V DC (0ms) |
| 2 Form A | E43028 | 25A 277V AC 25A 30V DC 1HP 125V AC 2HP 250V AC | LR26550 etc. | 25A 277V AC 25A 30V DC 1HP 125V AC 2HP 250V AC | 40006681 | 25A 250V AC (cosφ=1.0) 25A 250V AC (cosφ=0.4) 5A 110V DC (0ms) | UL E43028 | TV-10 | B 11 04 13461 293 | 25A 250V AC (cosφ=1.0) 25A 250V AC (cosφ=0.4) 8A 110V DC (0ms) |

NOTES

- The dust cover should not be removed since doing so may alter the characteristics.
- Avoid use under severe environmental conditions, such as high humidity, organic gas or in dust, oily locations and locations subjected to extremely frequent shock or vibrations.
- When mounting, use spring washers. Optimum fastening torque ranges from 49 to 68.6 N·m (5 to 7 kgf·cm).

- Firmly insert the receptacles so that there is no slack or looseness. To remove a receptacle, 19.6 to 39.2 N (2 to 4 kg) of pulling strength is required. Do not remove more than one receptacle at one time. Always remove one receptacle at a time and pull it straight outwards.
- When using the AC type, the operate time due to the in-rush phase is 20 ms or more. Therefore, it is necessary for you to verify the characteristics for your actual circuit.

- When using the push-on blocks for the screw terminal type, use crimped terminals and tighten the screw-down terminals to the torque below.
M4.5 screw:
147 to 166.6 N·cm (15 to 17 kgf·cm)
M4 screw:
117.6 to 137 N·cm (12 to 14 kgf·cm)
M3.5 screw:
78.4 to 98 N·cm (8 to 10 kgf·cm)

For Cautions for Use.

Mouser Electronics

Authorized Distributor

Click to View Pricing, Inventory, Delivery & Lifecycle Information:

Panasonic:

[HE2AN-Q-DC12V](#) [HE2AN-Q-DC24V](#) [HE1AN-AC120V](#) [HE1AN-Q-AC120V](#) [HE1AN-AC240V](#) [HE1AN-Q-AC240V](#)
[HE2AN-DC12V](#) [HE2AN-Q-AC120V](#) [HE1AN-Q-DC24V](#) [HE1AN-S-AC120V](#) [HE1AN-S-DC12V](#) [HE1AN-AC24V](#)
[HE2AN-Q-AC24V](#) [HE1AN-Q-DC12V](#) [HE1AN-Q-DC48V](#) [HE2AN-DC24V](#) [HE1AN-DC12V](#) [HE1AN-S-DC24V](#) [HE1AN-](#)
[DC24V](#) [HE2AN-S-DC24V](#) [HE2AN-SW-DC24V](#) [HE2AN-Q-AC240V](#) [HE1AN-DC6V](#) [HE1AN-AC12V](#) [HE1AN-AC48V](#)
[HE1AN-DC110V](#) [HE1AN-DC48V](#) [HE1AN-P-DC12V](#) [HE1AN-P-DC24V](#) [HE1AN-P-DC48V](#) [HE1AN-Q-AC12V](#) [HE1AN-](#)
[Q-AC24V](#) [HE1AN-Q-AC48V](#) [HE1AN-Q-DC110V](#) [HE1AN-Q-DC6V](#) [HE1AN-S-AC12V](#) [HE1AN-S-AC240V](#) [HE1AN-S-](#)
[AC24V](#) [HE1AN-S-AC48V](#) [HE1AN-S-DC110V](#) [HE1AN-S-DC48V](#) [HE1AN-S-DC6V](#) [HE1AN-SW-AC120V](#) [HE1AN-SW-](#)
[AC12V](#) [HE1AN-SW-AC240V](#) [HE1AN-SW-AC24V](#) [HE1AN-SW-DC110V](#) [HE1AN-SW-DC12V](#) [HE1AN-SW-DC24V](#)
[HE1AN-SW-DC6V](#) [HE2AN-AC120V](#) [HE2AN-AC12V](#) [HE2AN-AC240V](#) [HE2AN-AC24V](#) [HE2AN-AC48V](#) [HE2AN-](#)
[DC110V](#) [HE2AN-DC48V](#) [HE2AN-DC6V](#) [HE2AN-Q-AC12V](#) [HE2AN-Q-AC48V](#) [HE2AN-Q-DC110V](#) [HE2AN-Q-DC48V](#)
[HE2AN-Q-DC6V](#) [HE2AN-S-AC120V](#) [HE2AN-S-AC12V](#) [HE2AN-S-AC240V](#) [HE2AN-S-AC24V](#) [HE2AN-S-AC48V](#)
[HE2AN-S-DC110V](#) [HE2AN-S-DC12V](#) [HE2AN-S-DC48V](#) [HE2AN-S-DC6V](#) [HE2AN-SW-AC120V](#) [HE2AN-SW-AC240V](#)
[HE2AN-SW-AC24V](#) [HE2AN-SW-DC110V](#) [HE2AN-SW-DC12V](#) [HE2AN-SW-DC48V](#) [HE2AN-SW-DC6V](#) [HE2AN-P-](#)
[DC24V](#)