

0.1%, 25ppm, SC70 Shunt Voltage Reference with Multiple Reverse Breakdown Voltages

General Description

The MAX6138 is a precision, two-terminal shunt mode, bandgap voltage reference available in fixed reverse breakdown voltages of 1.2205V, 2.048V, 2.5V, 3.0V, 3.3V, 4.096V, and 5.0V. Ideal for space-critical applications, the MAX6138 is offered in the subminiature 3-pin SC70 surface-mount package (1.8mm X 1.8mm), 50% smaller than comparable devices in SOT23 surface-mount packages.

Laser-trimmed resistors ensure precise initial accuracy. With a 25ppm/°C temperature coefficient, the device is offered in three grades of initial accuracy ranging from 0.1% to 0.5%. The MAX6138 has a 60µA to 15mA shunt-current capability with low-dynamic impedance, ensuring stable reverse breakdown voltage accuracy over a wide range of operating temperatures and currents.

The MAX6138 does not require an external stabilizing capacitor while ensuring stability with capacitive loads. The MAX6138 is a higher precision device in a smaller package than the LM4040/LM4050.

Applications

Portable, Battery-Powered Equipment
 Notebook Computers
 Cell Phones
 Industrial Process Control

Pin Configuration

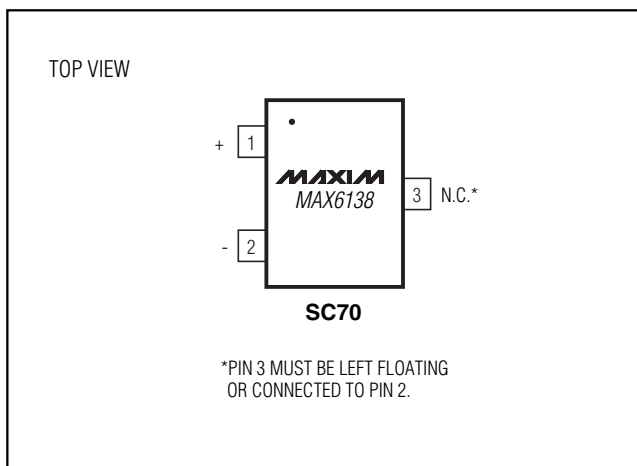

Features

- ◆ Ultra-Small 3-Pin SC70 Package
- ◆ 0.1% (max) Initial Accuracy
- ◆ 25ppm/°C (max) Temperature Coefficient
Guaranteed Over -40°C to +85°C Temperature Range
- ◆ Wide Operating Current Range: 60µA to 15mA
- ◆ Low 28µVRMS Output Noise (10Hz to 10kHz)
- ◆ 1.2205V, 2.048V, 2.5V, 3.0V, 3.3V, 4.096V, and 5.0V Fixed Reverse Breakdown Voltages
- ◆ No Output Capacitors Required
- ◆ Stable with Capacitive Loads

Selector Guide

PART	TEMP RANGE	PIN-PACKAGE	OUTPUT VOLTAGE (V)
MAX6138_EXR12-T	-40°C to +85°C	3 SC70-3	1.2205
MAX6138_EXR21-T	-40°C to +85°C	3 SC70-3	2.0480
MAX6138_EXR25-T	-40°C to +85°C	3 SC70-3	2.5000
MAX6138_EXR30-T	-40°C to +85°C	3 SC70-3	3.0000
MAX6138_EXR33-T	-40°C to +85°C	3 SC70-3	3.3000
MAX6138_EXR41-T	-40°C to +85°C	3 SC70-3	4.0960
MAX6138_EXR50-T	-40°C to +85°C	3 SC70-3	5.0000

Ordering Information appears at end of data sheet.

Typical Operating Circuit

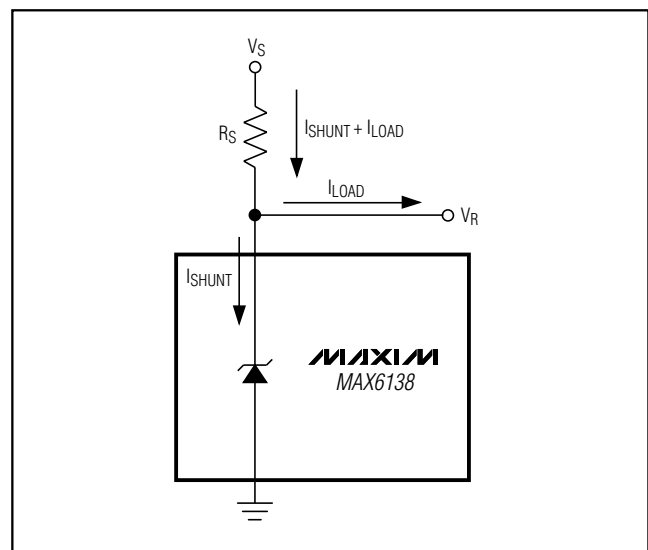

0.1%, 25ppm, SC70 Shunt Voltage Reference with Multiple Reverse Breakdown Voltages

ABSOLUTE MAXIMUM RATINGS

Reverse Current (cathode to anode)	20mA	Operating Temperature Range	-40°C to +125°C
Forward Current (anode to cathode)	10mA	Storage Temperature Range	-65°C to +150°C
Continuous Power Dissipation (T _A = +70°C)		Junction Temperature	+150°C
3-Pin SC70 (derate 2.17mW/°C above +70°C)	174mW	Lead Temperature (soldering, 10s)	+300°C

Stresses beyond those listed under "Absolute Maximum Ratings" may cause permanent damage to the device. These are stress ratings only, and functional operation of the device at these or any other conditions beyond those indicated in the operational sections of the specifications is not implied. Exposure to absolute maximum rating conditions for extended periods may affect device reliability.

ELECTRICAL CHARACTERISTICS—MAX6138_12 (1.2205V)

(I_R = 100μA, T_A = -40°C to +85°C, unless otherwise noted. Typical values are at T_A = +25°C.) (Note 1)

PARAMETER	SYMBOL	CONDITIONS	MIN	TYP	MAX	UNITS	
Reverse Breakdown Voltage (Note 2)	V _R	T _A = +25°C	MAX6138A (0.1%)	1.2193	1.2205	1.2217	V
			MAX6138B (0.2%)	1.2181	1.2205	1.2229	
			MAX6138C (0.5%)	1.2144	1.2205	1.2266	
Minimum Operating Current	I _{RMIN}			45	60	μA	
Reverse Voltage Temperature Coefficient (Notes 2, 3)	TC			4	25	ppm/°C	
Reverse Breakdown Voltage Change with Operating Current Change	ΔV _R /ΔI _R	I _{RMIN} ≤ I _R ≤ 1mA		0.3	1.0	mV	
		1mA ≤ I _R ≤ 12mA		2.5	8.0		
Reverse Dynamic Impedance (Note 3)	Z _R	I _R = 1mA, f = 120Hz, I _{AC} = 0.1I _R		0.3	0.8	Ω	
Wideband Noise	e _N	I _R = 10μA, 10Hz ≤ f ≤ 10kHz		20		μV _{RMS}	
Reverse Breakdown Voltage	ΔV _R	t = 1000h		120		ppm	

0.1%, 25ppm, SC70 Shunt Voltage Reference with Multiple Reverse Breakdown Voltages

MAX6138

ELECTRICAL CHARACTERISTICS—MAX6138_21 (2.048V)

($I_R = 100\mu\text{A}$, $T_A = -40^\circ\text{C}$ to $+85^\circ\text{C}$, unless otherwise noted. Typical values are at $T_A = +25^\circ\text{C}$.) (Note 1)

PARAMETER	SYMBOL	CONDITIONS		MIN	TYP	MAX	UNITS
Reverse Breakdown Voltage (Note 2)	V_R	$T_A = +25^\circ\text{C}$	MAX6138A (0.1%)	2.0460	2.0480	2.0500	V
			MAX6138B (0.2%)	2.0439	2.0480	2.0521	
			MAX6138C (0.5%)	2.0378	2.0480	2.0582	
Minimum Operating Current	I_{RMIN}			45		65	μA
Reverse Voltage Temperature Coefficient (Notes 2, 3)	TC				4	25	ppm/ $^\circ\text{C}$
Reverse Breakdown Voltage Change with Operating Current Change	$\Delta V_R/\Delta I_R$	$I_{RMIN} \leq I_R \leq 1\text{mA}$			0.3	1.0	mV
		$1\text{mA} \leq I_R \leq 15\text{mA}$			2.5	8.0	
Reverse Dynamic Impedance (Note 3)	Z_R	$I_R = 1\text{mA}$, $f = 120\text{Hz}$, $I_{AC} = 0.1I_R$			0.3	0.8	Ω
Wideband Noise	e_N	$10\text{Hz} \leq f \leq 10\text{kHz}$			28		μVRMS
Reverse Breakdown Voltage Long-Term Stability	ΔV_R	$t = 1000\text{h}$			120		ppm

ELECTRICAL CHARACTERISTICS—MAX6138_25 (2.5V)

($I_R = 100\mu\text{A}$, $T_A = -40^\circ\text{C}$ to $+85^\circ\text{C}$, unless otherwise noted. Typical values are at $T_A = +25^\circ\text{C}$.) (Note 1)

PARAMETER	SYMBOL	CONDITIONS		MIN	TYP	MAX	UNITS
Reverse Breakdown Voltage (Note 2)	V_R	$T_A = +25^\circ\text{C}$	MAX6138A (0.1%)	2.4975	2.5000	2.5025	V
			MAX6138B (0.2%)	2.4950	2.5000	2.5050	
			MAX6138C (0.2%)	2.4875	2.5000	2.5125	
Minimum Operating Current	I_{RMIN}			45		65	μA
Reverse Voltage Temperature Coefficient (Notes 2, 3)	TC				4	25	ppm/ $^\circ\text{C}$
Reverse Breakdown Voltage Change with Operating Current Change	$\Delta V_R/\Delta I_R$	$I_{RMIN} \leq I_R \leq 1\text{mA}$			0.3	1.0	mV
Reverse Breakdown Voltage Change with Operating Current Change	$\Delta V_R/\Delta I_R$	$1\text{mA} \leq I_R \leq 15\text{mA}$			2.5	8.0	mV
Reverse Dynamic Impedance (Note 3)	Z_R	$I_R = 1\text{mA}$, $f = 120\text{Hz}$, $I_{AC} = 0.1I_R$			0.3	0.8	Ω
Wideband Noise	e_N	$10\text{Hz} \leq f \leq 10\text{kHz}$			35		μVRMS
Reverse Breakdown Voltage Long-Term Stability	ΔV_R	$t = 1000\text{h}$			120		ppm

0.1%, 25ppm, SC70 Shunt Voltage Reference with Multiple Reverse Breakdown Voltages

ELECTRICAL CHARACTERISTICS—MAX6138_30 (3.0V)

($I_R = 100\mu\text{A}$, $T_A = -40^\circ\text{C}$ to $+85^\circ\text{C}$, unless otherwise noted. Typical values are at $T_A = +25^\circ\text{C}$.) (Note 1)

PARAMETER	SYMBOL	CONDITIONS	MIN	TYP	MAX	UNITS	
Reverse Breakdown Voltage (Note 2)	V_R	$T_A = +25^\circ\text{C}$	MAX6138A (0.1%)	2.9970	3.0000	3.0030	V
			MAX6138B (0.2%)	2.9940	3.0000	3.0060	
			MAX6138C (0.5%)	2.9850	3.0000	3.0150	
Minimum Operating Current	I_{RMIN}			45	65	μA	
Reverse Voltage Temperature Coefficient (Notes 2, 3)	TC			4	25	ppm/ $^\circ\text{C}$	
Reverse Breakdown Voltage Change with Operating Current Change	$\Delta V_R/\Delta I_R$	$I_{RMIN} \leq I_R \leq 1\text{mA}$		0.3	1.0	mV	
		$1\text{mA} \leq I_R \leq 15\text{mA}$		2.5	8.0		
Reverse Dynamic Impedance (Note 3)	Z_R	$I_R = 1\text{mA}$, $f = 120\text{Hz}$, $I_{AC} = 0.1I_R$		0.3	0.8	Ω	
Wideband Noise	e_N	$10\text{Hz} \leq f \leq 10\text{kHz}$		45		μVRMS	
Reverse Breakdown Voltage Long-Term Stability	ΔV_R	$t = 1000\text{h}$		120		ppm	

ELECTRICAL CHARACTERISTICS—MAX6138_33 (3.3V)

($I_R = 100\mu\text{A}$, $T_A = -40^\circ\text{C}$ to $+85^\circ\text{C}$, unless otherwise noted. Typical values are at $T_A = +25^\circ\text{C}$.) (Note 1)

PARAMETER	SYMBOL	CONDITIONS	MIN	TYP	MAX	UNITS	
Reverse Breakdown Voltage (Note 2)	V_R	$T_A = +25^\circ\text{C}$	MAX6138A (0.1%)	3.2967	3.3000	3.3033	V
			MAX6138B (0.2%)	3.2934	3.3000	3.3066	
			MAX6138C (0.5%)	3.2835	3.3000	3.3165	
Minimum Operating Current	I_{RMIN}			45	67	μA	
Reverse Voltage Temperature Coefficient (Notes 2, 3)	TC			4	25	ppm/ $^\circ\text{C}$	
Reverse Breakdown Voltage Change with Operating Current Change	$\Delta V_R/\Delta I_R$	$I_{RMIN} \leq I_R \leq 1\text{mA}$		0.3	1.0	mV	
		$1\text{mA} \leq I_R \leq 15\text{mA}$			8.0		
Reverse Dynamic Impedance (Note 3)	Z_R	$I_R = 1\text{mA}$, $f = 120\text{Hz}$, $I_{AC} = 0.1I_R$		0.3	0.8	Ω	
Wideband Noise	e_N	$10\text{Hz} \leq f \leq 10\text{kHz}$		50		μVRMS	
Reverse Breakdown Voltage Long-Term Stability	ΔV_R	$t = 1000\text{h}$		120		ppm	

0.1%, 25ppm, SC70 Shunt Voltage Reference with Multiple Reverse Breakdown Voltages

MAX6138

ELECTRICAL CHARACTERISTICS—MAX6138_41 (4.096V)

($I_R = 100\mu\text{A}$, $T_A = -40^\circ\text{C}$ to $+85^\circ\text{C}$, unless otherwise noted. Typical values are at $T_A = +25^\circ\text{C}$.) (Note 1)

PARAMETER	SYMBOL	CONDITIONS	MIN	TYP	MAX	UNITS	
Reverse Breakdown Voltage (Note 2)	V_R	$T_A = +25^\circ\text{C}$	MAX6138A (0.1%)	4.0919	4.0960	4.1001	V
			MAX6138B (0.2%)	4.0878	4.0960	4.1042	
			MAX6138C (0.5%)	4.0755	4.0960	4.1165	
Minimum Operating Current	I_{RMIN}			50	73	μA	
Reverse Voltage Temperature Coefficient (Notes 2, 3)	TC			4	25	ppm/ $^\circ\text{C}$	
Reverse Breakdown Voltage Change with Operating Current Change	$\Delta V_R/\Delta I_R$	$I_{RMIN} \leq I_R \leq 1\text{mA}$		0.5	1.2	mV	
		$1\text{mA} \leq I_R \leq 15\text{mA}$		3.0	10.0		
Reverse Dynamic Impedance (Note 3)	Z_R	$I_R = 1\text{mA}$, $f = 120\text{Hz}$, $I_{AC} = 0.1I_R$		0.5	1.0	Ω	
Wideband Noise	eN	$10\text{Hz} \leq f \leq 10\text{kHz}$		64		μVRMS	
Reverse Breakdown Voltage Long-Term Stability	ΔV_R	$t = 1000\text{h}$		120		ppm	

ELECTRICAL CHARACTERISTICS—MAX6138_50 (5.0V)

($I_R = 100\mu\text{A}$, $T_A = -40^\circ\text{C}$ to $+85^\circ\text{C}$, unless otherwise noted. Typical values are at $T_A = +25^\circ\text{C}$.) (Note 1)

PARAMETER	SYMBOL	CONDITIONS	MIN	TYP	MAX	UNITS	
Reverse Breakdown Voltage (Note 2)	V_R	$T_A = +25^\circ\text{C}$	MAX6138A (0.1%)	4.9950	5.0000	5.0050	V
			MAX6138B (0.2%)	4.9900	5.0000	5.0100	
			MAX6138C (0.5%)	4.9750	5.0000	5.0250	
Minimum Operating Current	I_{RMIN}			54	80	μA	
Reverse Voltage Temperature Coefficient (Notes 2, 3)	TC			4	25	ppm/ $^\circ\text{C}$	
Reverse Breakdown Voltage Change with Operating Current Change	$\Delta V_R/\Delta I_R$	$I_{RMIN} \leq I_R \leq 1\text{mA}$		0.5	1.4	mV	
		$1\text{mA} \leq I_R \leq 15\text{mA}$		3.5	12.0		
Reverse Dynamic Impedance (Note 3)	Z_R	$I_R = 1\text{mA}$, $f = 120\text{Hz}$, $I_{AC} = 0.1I_R$		0.5	1.1	Ω	
Wideband Noise	eN	$10\text{Hz} \leq f \leq 10\text{kHz}$		80		μVRMS	
Reverse Breakdown Voltage Long-Term Stability	ΔV_R	$t = 1000\text{h}$		120		ppm	

Note 1: All devices are 100% production tested at $+25^\circ\text{C}$ and are guaranteed by correlation for $T_A = T_{MAX}$ to T_{MIN} , as specified.

Note 2: TC is measured by the “box” method, i.e. $(V_{MAX} - V_{MIN}) / (T_{MAX} - T_{MIN})$

Note 3: Guaranteed by design.

0.1%, 25ppm, SC70 Shunt Voltage Reference with Multiple Reverse Breakdown Voltages

Typical Operating Characteristics

($I_R = 100\mu A$, $T_A = +25^\circ C$, unless otherwise noted.)

REVERSE CHARACTERISTICS AND MINIMUM OPERATING CURRENT

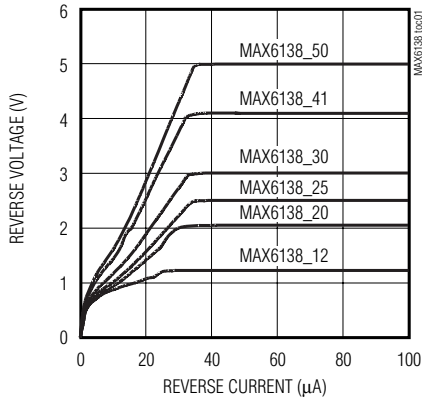

MAX6138_12 TEMPERATURE DRIFT

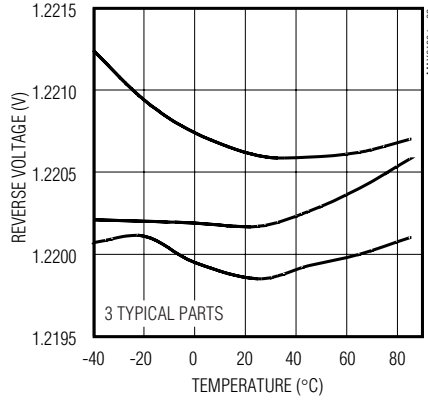

MAX6138_25 TEMPERATURE DRIFT

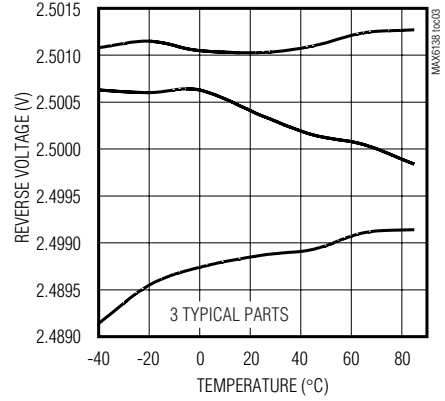

MAX6138_50 TEMPERATURE DRIFT

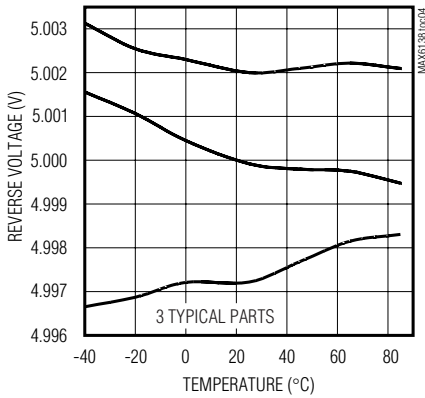

MAX6138_12 REVERSE VOLTAGE vs. I_{SHUNT}

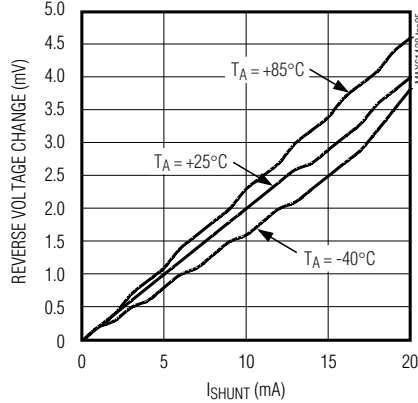

0.1%, 25ppm, SC70 Shunt Voltage Reference with Multiple Reverse Breakdown Voltages

Typical Operating Characteristics (continued)

($I_R = 100\mu A$, $T_A = +25^\circ C$, unless otherwise noted.)

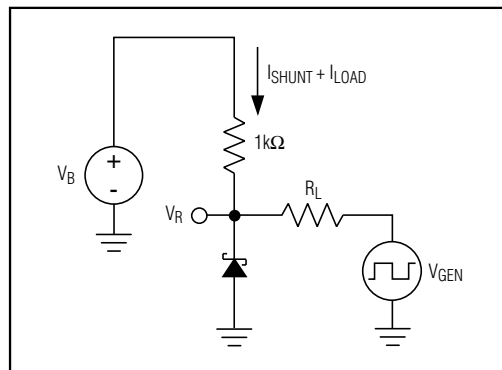
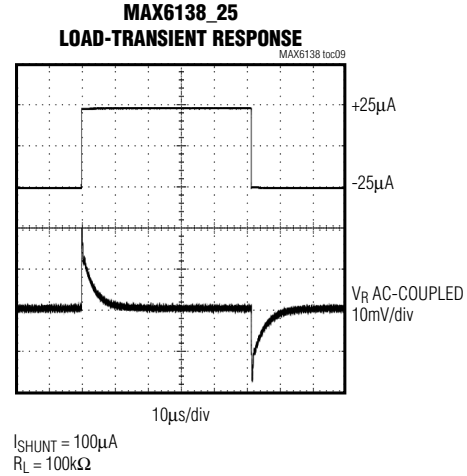
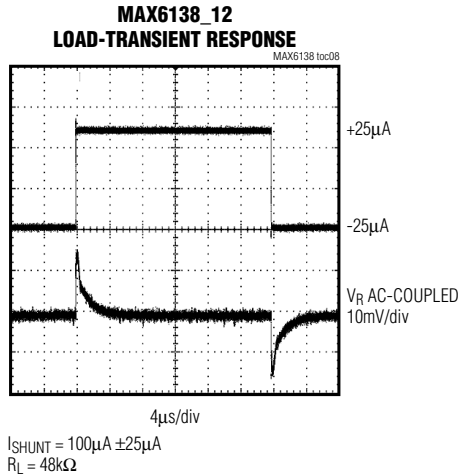
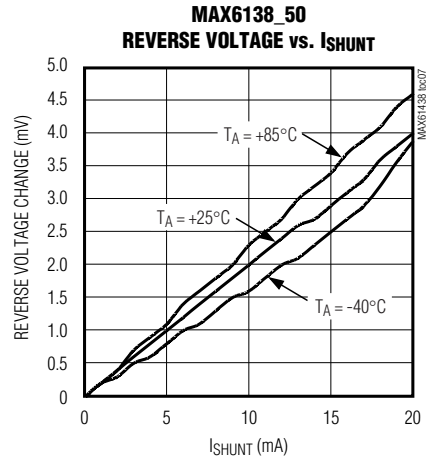
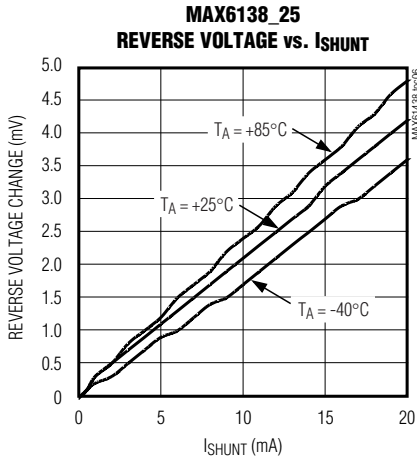

Figure 1. Load-Transient Circuit

0.1%, 25ppm, SC70 Shunt Voltage Reference with Multiple Reverse Breakdown Voltages

Typical Operating Characteristics (continued)

($I_R = 100\mu\text{A}$, $T_A = +25^\circ\text{C}$, unless otherwise noted.)

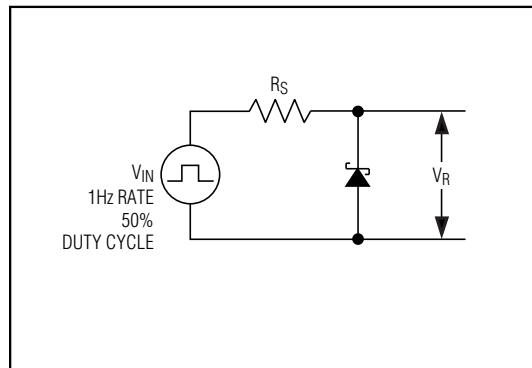
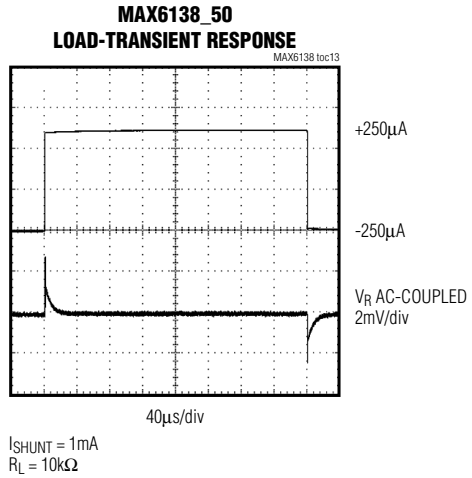
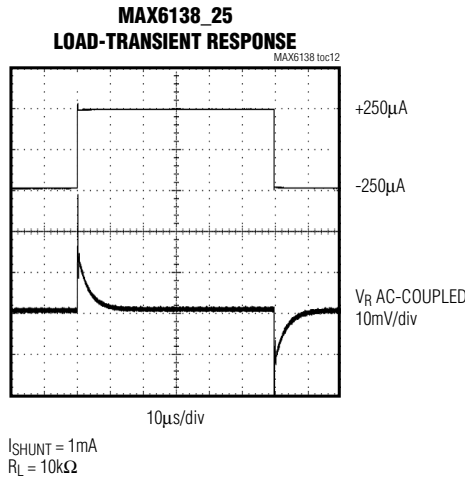
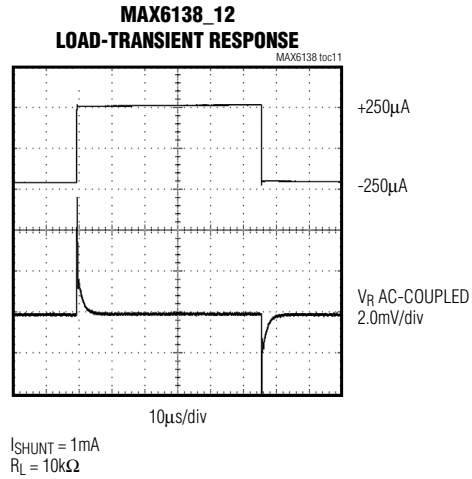
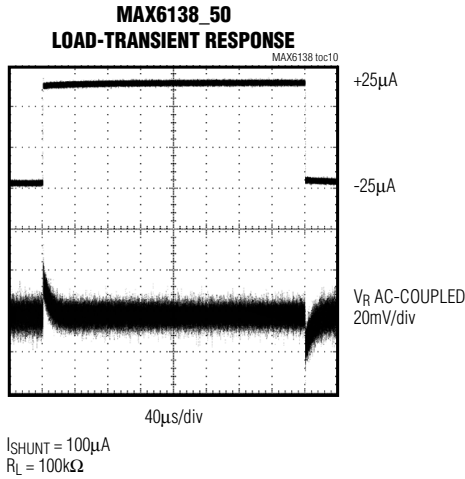

Figure 2. Startup Characteristics Test Circuit

0.1%, 25ppm, SC70 Shunt Voltage Reference with Multiple Reverse Breakdown Voltages

MAX6138

Typical Operating Characteristics (continued)

($I_R = 100\mu\text{A}$, $T_A = +25^\circ\text{C}$, unless otherwise noted.)

MAX6138_12
LOAD-TRANSIENT RESPONSE

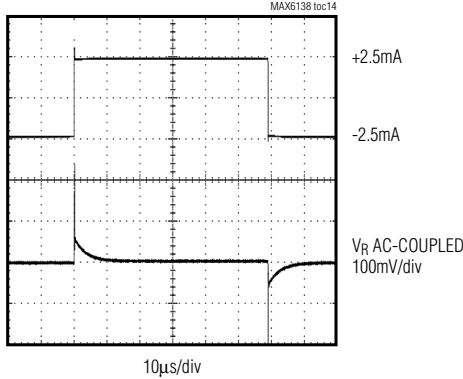

$I_{\text{SHUNT}} = 10\text{mA}$
 $R_L = 1\text{k}\Omega$

MAX6138_25
LOAD-TRANSIENT RESPONSE

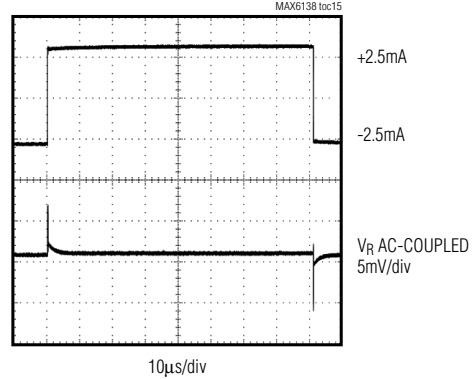

$I_{\text{SHUNT}} = 10\text{mA}$
 $R_L = 1\text{k}\Omega$

MAX6138_50
LOAD-TRANSIENT RESPONSE

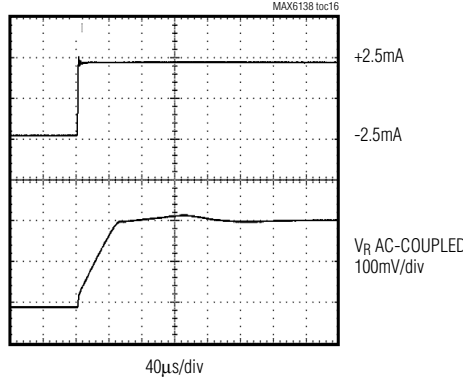

$I_{\text{SHUNT}} = 10\text{mA}$
 $R_L = 1\text{k}\Omega$

MAX6138_12
STARTUP CHARACTERISTICS

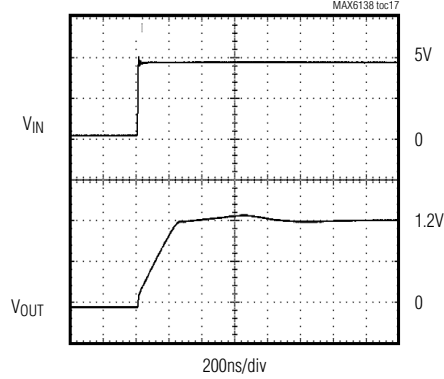

$I_{\text{SHUNT}} = 100\mu\text{A}$
 $R_S = 30\text{k}\Omega$

MAX6138_25
STARTUP CHARACTERISTICS

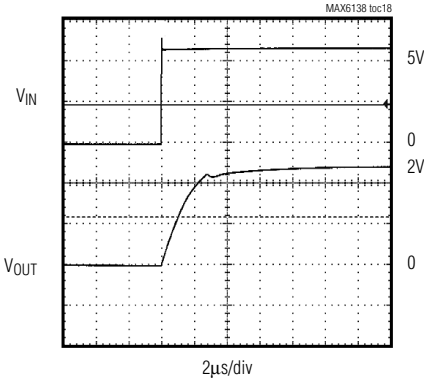

$I_{\text{SHUNT}} = 100\mu\text{A}$
 $R_S = 30\text{k}\Omega$

MAX6138_50
STARTUP CHARACTERISTICS

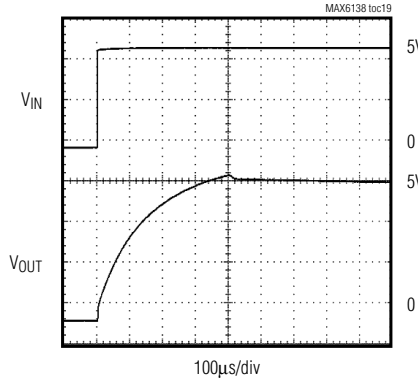

$I_{\text{SHUNT}} = 100\mu\text{A}$
 $R_S = 16\text{k}\Omega$

MAX6138_12
OUTPUT IMPEDANCE vs. FREQUENCY

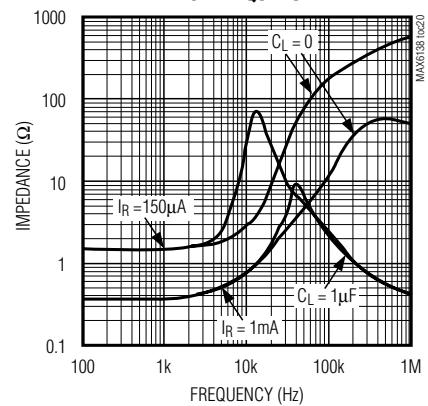

0.1%, 25ppm, SC70 Shunt Voltage Reference with Multiple Reverse Breakdown Voltages

Typical Operating Characteristics (continued)

($I_R = 100\mu A$, $T_A = +25^\circ C$, unless otherwise noted.)

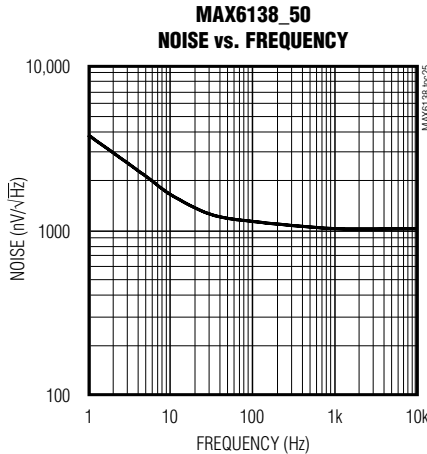
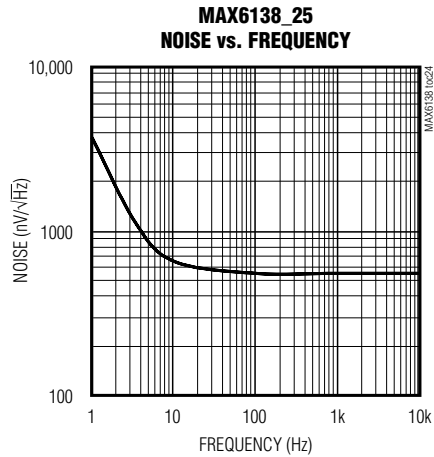
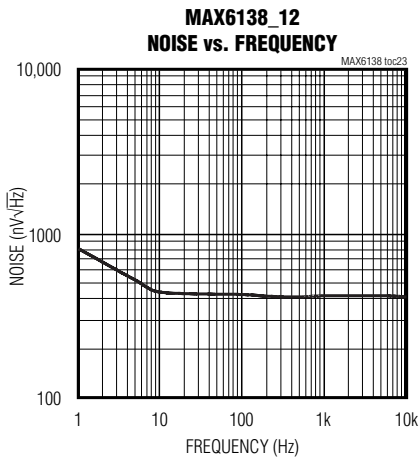
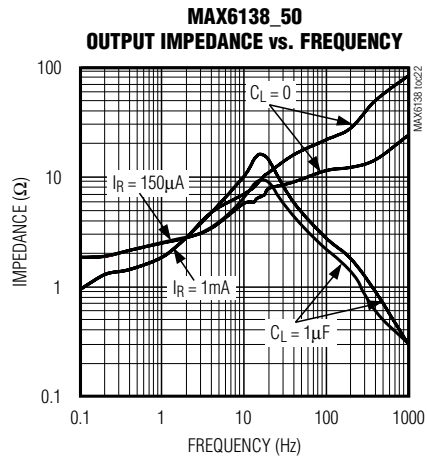
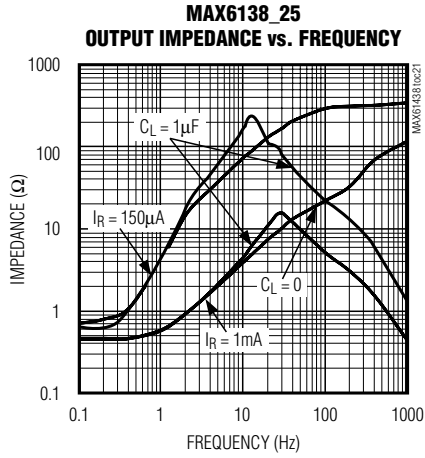

0.1%, 25ppm, SC70 Shunt Voltage Reference with Multiple Reverse Breakdown Voltages

MAX6138

Pin Description

PIN	NAME	FUNCTION
1	+	Positive Terminal of the Shunt Reference
2	-	Negative Terminal of the Shunt Reference
3	N.C.	No Connection. Leave this pin unconnected or connect to Pin 2.

Detailed Description

The MAX6138 shunt reference uses the bandgap principle to produce a stable, accurate voltage. The device behaves similarly to an ideal zener diode; a fixed voltage is maintained across its output terminals when biased with 60µA to 15mA of reverse current. The MAX6138 behaves similarly to a silicon diode when biased with forward currents up to 10mA.

Figure 3 shows a typical operating circuit. The MAX6138 is ideal for providing a stable reference from a high-voltage power supply.

Applications Information

The MAX6138's internal pass transistor is used to maintain a constant output voltage (V_{SHUNT}) by sinking the necessary amount of current across a source resistor. The source resistance (R_S) is determined from the load current (I_{LOAD}) range, supply voltage (V_S) variations, V_{SHUNT} , and desired quiescent current.

Choose the value of R_S when V_S is at a minimum and I_{LOAD} is at a maximum. Maintain a minimum I_{SHUNT} of 60µA at all times. The R_S value should be large enough to keep I_{SHUNT} less than 15mA for proper regulation when V_S is maximum and I_{LOAD} is at a minimum. To prevent damage to the device, I_{SHUNT} should never exceed 20mA.

Therefore, the value of R_S is bounded by the following equation:

$$[V_S(\text{MIN}) - V_R] / [60\mu\text{A} + I_{LOAD(\text{MAX})}] > R_S >$$

$$[V_S(\text{MAX}) - V_R] / [20\text{mA} + I_{LOAD(\text{MIN})}]$$

Choosing a larger resistance minimizes the total power dissipation in the circuit by reducing the shunt current ($P_{D(\text{TOTAL})} = V_S \times I_{SHUNT}$). Provide a safety margin to incorporate the worst-case tolerance of the resistor used. Ensure that the resistor's power rating is adequate, using the following general power equation:

$$P_{DR} = I_{SHUNT} \times (V_S(\text{MAX}) - V_{SHUNT})$$

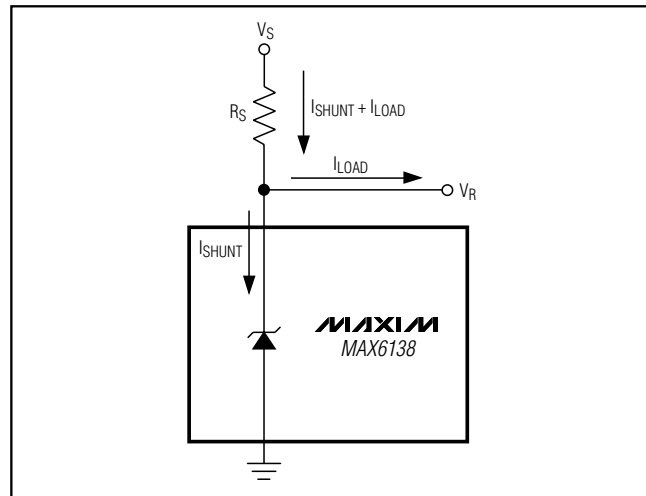

Figure 3. Typical Operating Circuit

Output Capacitance

The MAX6138 does not require an external capacitor for operational stability and is stable for any output capacitance.

Temperature Performance

The MAX6138 typically exhibits an output voltage temperature coefficient within $\pm 4\text{ppm}/^\circ\text{C}$. The polarity of the temperature coefficient may be different from one device to another; some may have positive coefficients, and others may have negative coefficients.

Chip Information

TRANSISTOR COUNT: 70

PROCESS: BiCMOS

0.1%, 25ppm, SC70 Shunt Voltage Reference with Multiple Reverse Breakdown Voltages

Ordering Information

PART	OUTPUT VOLTAGE (V)	INITIAL ACCURACY (%)	TEMP RANGE	PIN-PACKAGE	TOP MARK
MAX6138AEXR12-T	1.2205	0.1	-40°C to +85°C	3 SC70-3	AEW
MAX6138BEXR12-T	1.2205	0.2	-40°C to +85°C	3 SC70-3	AEX
MAX6138CEXR12-T	1.2205	0.5	-40°C to +85°C	3 SC70-3	AEY
MAX6138AEXR21-T	2.0480	0.1	-40°C to +85°C	3 SC70-3	AFA
MAX6138BEXR21-T	2.0480	0.2	-40°C to +85°C	3 SC70-3	AFB
MAX6138CEXR21-T	2.0480	0.5	-40°C to +85°C	3 SC70-3	AFC
MAX6138AEXR25-T	2.5000	0.1	-40°C to +85°C	3 SC70-3	AFE
MAX6138BEXR25-T	2.5000	0.2	-40°C to +85°C	3 SC70-3	AFF
MAX6138CEXR25-T	2.5000	0.5	-40°C to +85°C	3 SC70-3	AFG
MAX6138AEXR30-T	3.0000	0.1	-40°C to +85°C	3 SC70-3	AFI
MAX6138BEXR30-T	3.0000	0.2	-40°C to +85°C	3 SC70-3	AFJ
MAX6138CEXR30-T	3.0000	0.5	-40°C to +85°C	3 SC70-3	AFK
MAX6138AEXR33-T	3.3000	0.1	-40°C to +85°C	3 SC70-3	ANG
MAX6138BEXR33-T	3.3000	0.2	-40°C to +85°C	3 SC70-3	ANH
MAX6138CEXR33-T	3.3000	0.5	-40°C to +85°C	3 SC70-3	ANI
MAX6138AEXR41-T	4.0960	0.1	-40°C to +85°C	3 SC70-3	AFM
MAX6138BEXR41-T	4.0960	0.2	-40°C to +85°C	3 SC70-3	AFN
MAX6138CEXR41-T	4.0960	0.5	-40°C to +85°C	3 SC70-3	AFO
MAX6138AEXR50-T	5.0000	0.1	-40°C to +85°C	3 SC70-3	AFQ
MAX6138BEXR50-T	5.0000	0.2	-40°C to +85°C	3 SC70-3	AFR
MAX6138CEXR50-T	5.0000	0.5	-40°C to +85°C	3 SC70-3	AFS

0.1%, 25ppm, SC70 Shunt Voltage Reference with Multiple Reverse Breakdown Voltages

Package Information

MAX6138

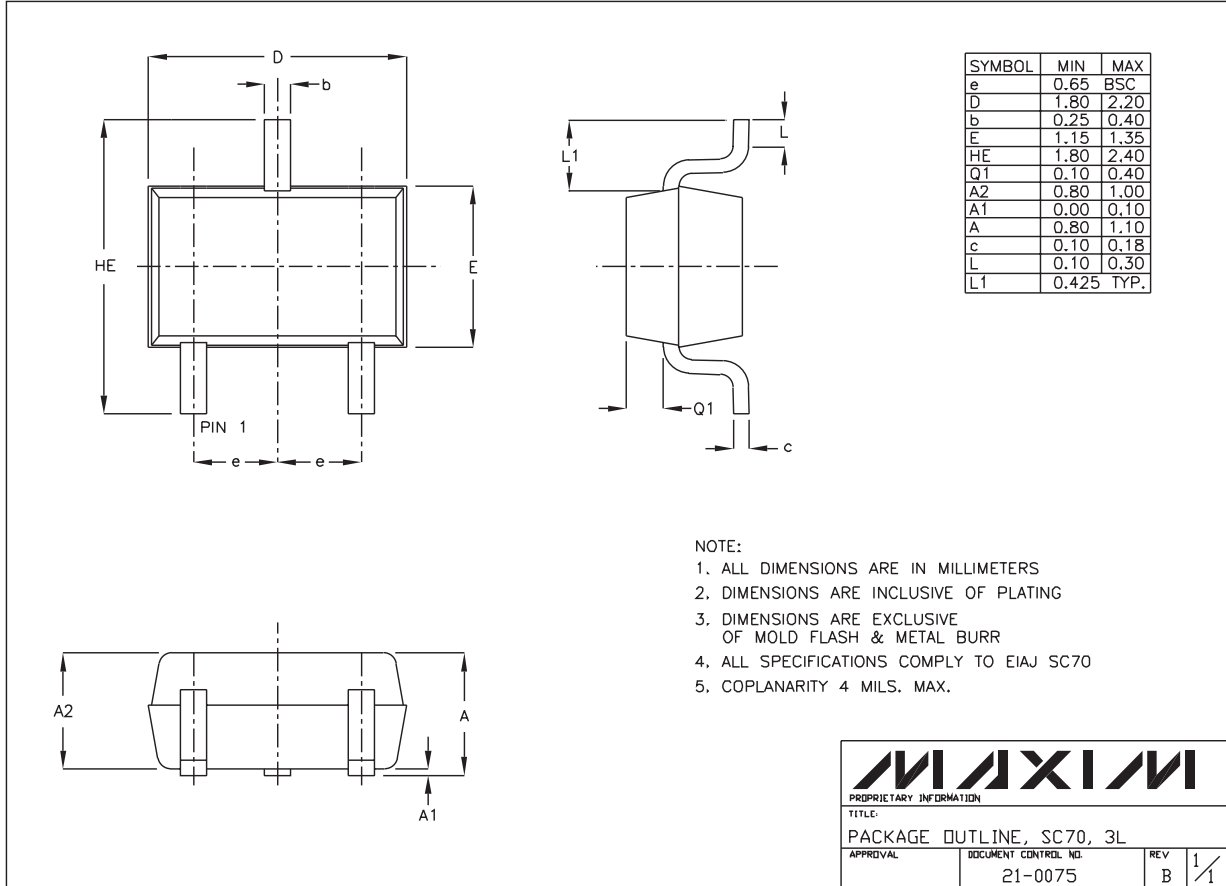

Maxim cannot assume responsibility for use of any circuitry other than circuitry entirely embodied in a Maxim product. No circuit patent licenses are implied. Maxim reserves the right to change the circuitry and specifications without notice at any time.

Maxim Integrated Products, 120 San Gabriel Drive, Sunnyvale, CA 94086 408-737-7600 _____ 13

Mouser Electronics

Authorized Distributor

Click to View Pricing, Inventory, Delivery & Lifecycle Information:

Maxim Integrated:

[MAX6006AEUR+T](#) [MAX6006BEUR+T](#) [MAX6007AEUR+T](#) [MAX6007BEUR+T](#) [MAX6008AESA+](#) [MAX6008AEUR+T](#)
[MAX6008BEUR+T](#) [MAX6009AEUR+T](#) [MAX6009BEUR+T](#) [MAX6138AEXR30+T](#) [MAX6138CEXR12+T](#)
[MAX6138CEXR25+T](#) [MAX6006AESA+](#) [MAX6006AESA+T](#) [MAX6006BESA+](#) [MAX6006BESA+T](#) [MAX6008AESA+T](#)
[MAX6008BESA+](#) [MAX6008BESA+T](#) [MAX6138AEXR12+T](#) [MAX6138AEXR21+T](#) [MAX6138AEXR33+T](#)
[MAX6138AEXR41+T](#) [MAX6138AEXR50+T](#) [MAX6138BEXR12+T](#) [MAX6138BEXR25+T](#) [MAX6138BEXR30+T](#)
[MAX6138BEXR33+T](#) [MAX6138BEXR41+T](#) [MAX6138BEXR50+T](#) [MAX6138CEXR21+T](#) [MAX6138CEXR30+T](#)
[MAX6138CEXR33+T](#) [MAX6138CEXR41+T](#) [MAX6138CEXR50+T](#) [MAX6138BEXR21+T](#) [MAX6138AEXR25+T](#)
[MAX6138BEXR33-T](#) [MAX6138AEXR12+](#) [MAX6138CEXR21](#) [MAX6008AEUR/V+T](#)