

FEATURES

- 0.5 Ω typical on resistance
- 0.8 Ω maximum on resistance at 125°C
- 1.65 V to 3.6 V operation
- Automotive temperature range: -40°C to +125°C
- High current carrying capability: 300 mA continuous
- Rail-to-rail switching operation
- Fast switching times <25 ns
- Typical power consumption (<0.1 μ W)

APPLICATIONS

- MP3 players
- Power routing
- Battery-powered systems
- PCMCIA cards
- Cellular phones
- Modems
- Audio and video signal routing
- Communication systems

GENERAL DESCRIPTION

The ADG804 is a low voltage 4-channel CMOS multiplexer comprising four single channels. This device offers ultralow on resistance of less than 0.8 Ω over the full temperature range. The digital inputs can handle 1.8 V logic with a 2.7 V to 3.6 V supply.

The ADG804 switches one of four inputs to a common output, D, as determined by the 3-bit binary address lines, A0, A1, and EN. A Logic 0 on the EN pin disables the device. The ADG804 has break-before-make switching.

The ADG804 is fully specified for 3.3 V, 2.5 V, and 1.8 V supply operation. It is available in a 10-lead MSOP package.

FUNCTIONAL BLOCK DIAGRAM

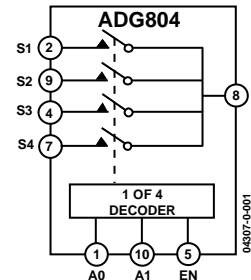

Figure 1.

PRODUCT HIGHLIGHTS

1. <0.8 Ω over full temperature range of -40°C to +125°C.
2. Single 1.65 V to 3.6 V operation.
3. Operational with 1.8 V CMOS logic.
4. High current handling capability (300 mA continuous current at 3.3 V).
5. Low THD + N (0.02% typ).
6. Small 10-lead MSOP package.

Rev. A

Information furnished by Analog Devices is believed to be accurate and reliable. However, no responsibility is assumed by Analog Devices for its use, nor for any infringements of patents or other rights of third parties that may result from its use. Specifications subject to change without notice. No license is granted by implication or otherwise under any patent or patent rights of Analog Devices. Trademarks and registered trademarks are the property of their respective owners.

TABLE OF CONTENTS

Revision History	2	Typical Performance Characteristics	8
Specifications.....	3	Test Circuits.....	11
Absolute Maximum Ratings.....	6	Outline Dimensions	13
ESD Caution.....	6	Ordering Guide	13
Pin Configuration.....	7		

REVISION HISTORY

9/11—Rev. 0 to Rev. A

Changes to Maximum Leakage Currents Parameter and Conditions, Table 1.....	3
Changes to Maximum Leakage Currents Parameter and Conditions, Table 2.....	4
Changes to Maximum Leakage Currents Parameter and Conditions, Table 3.....	5
Added Lead Temperature Parameter	6
Updated Outline Dimensions	13
Changes to Ordering Guide	13

4/04—Revision 0: Initial Version

SPECIFICATIONS

$V_{DD} = 2.7\text{ V to }3.6\text{ V}$, $GND = 0\text{ V}$, unless otherwise noted.¹

Table 1.

Parameter	+25°C	-40°C to +85°C	-40°C to +125°C	Unit	Test Conditions/Comments
ANALOG SWITCH					
Analog Signal Range			0 V to V_{DD}	V	
On Resistance (R_{ON})	0.5			Ω typ	$V_{DD} = 2.7\text{ V}$; $V_S = 0\text{ V to }V_{DD}$, $I_S = 10\text{ mA}$; Figure 18
	0.65	0.75	0.8	Ω max	
On Resistance Match between Channels (ΔR_{ON})	0.04			Ω typ	$V_{DD} = 2.7\text{ V}$; $V_S = 0.65\text{ V}$, $I_S = 10\text{ mA}$
		0.075	0.08	Ω max	
On Resistance Flatness ($R_{FLAT(ON)}$)	0.1			Ω typ	$V_{DD} = 2.7\text{ V}$; $V_S = 0\text{ V to }V_{DD}$,
		0.15	0.16	Ω max	$I_S = 10\text{ mA}$
LEAKAGE CURRENTS					
Source Off Leakage I_S (OFF)	± 0.1			nA typ	$V_{DD} = 3.6\text{ V}$
	± 2			nA max	$V_S = 1\text{ V}/2.6\text{ V}$; $V_D = 2.6\text{ V}/1\text{ V}$; Figure 19
Drain Off Leakage I_D (OFF)	± 0.1			nA typ	$V_S = 1\text{ V}/2.6\text{ V}$; $V_D = 2.6\text{ V}/1\text{ V}$; Figure 19
	± 2			nA max	
Channel On Leakage I_D , I_S (ON)	± 0.1			nA typ	$V_S = V_D = 1\text{ V or }2.6\text{ V}$; Figure 20
	± 2			nA max	
DIGITAL INPUTS					
Input High Voltage, V_{INH}			2	V min	
Input Low Voltage, V_{INL}			0.8	V max	
Input Current I_{INL} or I_{INH}	0.005			μA typ	$V_{IN} = V_{INL}$ or V_{INH}
			± 0.1	μA max	
C_{IN} , Digital Input Capacitance	4			pF typ	
DYNAMIC CHARACTERISTICS²					
$t_{TRANSITION}$	24			ns typ	$R_L = 50\ \Omega$, $C_L = 35\text{ pF}$
	30	32	35	ns max	$V_S = 1.5\text{ V}/0\text{ V}$; Figure 21
$t_{ON\text{-}ENABLE}$	23			ns typ	$R_L = 50\ \Omega$, $C_L = 35\text{ pF}$
	29	30	31	ns max	$V_S = 1.5\text{ V}/0\text{ V}$; Figure 23
$t_{OFF\text{-}ENABLE}$	5			ns typ	$R_L = 50\ \Omega$, $C_L = 35\text{ pF}$
	6	7	8	ns max	$V_S = 1.5\text{ V}$; Figure 23
Break-Before-Make Time Delay (t_{BBM})	20			ns typ	$R_L = 50\ \Omega$, $C_L = 35\text{ pF}$
			5	ns min	$V_{S1} = V_{S2} = 1.5\text{ V}$; Figure 22
Charge Injection	28			pC typ	$V_S = 1.5\text{ V}$, $R_S = 0\ \Omega$, $C_L = 1\text{ nF}$; Figure 24
Off Isolation	-67			dB typ	$R_L = 50\ \Omega$, $C_L = 5\text{ pF}$, $f = 100\text{ kHz}$; Figure 25
Channel-to-Channel Crosstalk	-75			dB typ	$R_L = 50\ \Omega$, $C_L = 5\text{ pF}$, $f = 100\text{ kHz}$; Figure 27
Total Harmonic Distortion (THD+N)	0.02			%	$R_L = 32\ \Omega$, $f = 20\text{ Hz to }20\text{ kHz}$, $V_S = 2\text{ V p-p}$
Insertion Loss	0.06			dB typ	$R_L = 50\ \Omega$, $C_L = 5\text{ pF}$, $f = 100\text{ kHz}$
-3 dB Bandwidth	33			MHz typ	$R_L = 50\ \Omega$, $C_L = 5\text{ pF}$; Figure 26
C_S (OFF)	24			pF typ	
C_D (OFF)	105			pF typ	
C_D , C_S (ON)	125			pF typ	
POWER REQUIREMENTS					
I_{DD}	0.003			μA typ	$V_{DD} = 3.6\text{ V}$
		1.0	4	μA max	Digital inputs = 0 V or 3.6 V

¹ Temperature range, Y version: -40°C to +125°C.

² Guaranteed by design, not subject to production test.

$V_{DD} = 2.5 \text{ V} \pm 0.2 \text{ V}$, $GND = 0 \text{ V}$, unless otherwise noted.¹

Table 2.

Parameter	+25°C	-40°C to +85°C	-40°C to +125°C	Unit	Test Conditions/Comments
ANALOG SWITCH					
Analog Signal Range			0 V to V_{DD}	V	
On Resistance (R_{ON})	0.65			Ω typ	$V_{DD} = 2.3 \text{ V}$; $V_S = 0 \text{ V to } V_{DD}$; $I_S = 10 \text{ mA}$; Figure 18
	0.77	0.8	0.88	Ω max	
On Resistance Match between Channels (ΔR_{ON})	0.4			Ω typ	$V_{DD} = 2.3 \text{ V}$; $V_S = 0.7 \text{ V}$; $I_S = 10 \text{ mA}$
		0.08	0.085	Ω max	
On Resistance Flatness ($R_{FLAT(ON)}$)	0.16			Ω typ	$V_{DD} = 2.3 \text{ V}$; $V_S = 0 \text{ V to } V_{DD}$; $I_S = 10 \text{ mA}$
		0.23	0.24	Ω max	
LEAKAGE CURRENTS					
Source Off Leakage I_S (OFF)	± 0.1			nA typ	$V_{DD} = 2.7 \text{ V}$ $V_S = 1 \text{ V/2 V}$, $V_D = 2 \text{ V/1 V}$; Figure 19
	± 2			nA max	
Drain Off Leakage I_D (OFF)	± 0.1			nA typ	$V_S = 1/2 \text{ V}$, $V_D = 2/1 \text{ V}$; Figure 19
	± 2			nA max	
Channel On Leakage I_D, I_S (ON)	± 0.1			nA typ	$V_S = V_D = 1 \text{ V or } 2 \text{ V}$; Figure 20
	± 2			nA max	
DIGITAL INPUTS					
Input High Voltage, V_{INH}			1.7	V min	
Input Low Voltage, V_{INL}			0.7	V max	
Input Current I_{INL} or I_{INH}	0.005			μA typ	$V_{IN} = V_{INL}$ or V_{INH}
			± 0.1	μA max	
C_{IN} , Digital Input Capacitance	4			pF typ	
DYNAMIC CHARACTERISTICS²					
$T_{TRANSITION}$	25			ns typ	$R_L = 50 \Omega$, $C_L = 35 \text{ pF}$
	31	33	35	ns max	$V_S = 1.5 \text{ V/0 V}$; Figure 21
t_{ON} ENABLE	25			ns typ	$R_L = 50 \Omega$, $C_L = 35 \text{ pF}$
	30	32	34	ns max	$V_S = 1.5 \text{ V/0 V}$; Figure 22
t_{OFF} ENABLE	5			ns typ	$R_L = 50 \Omega$, $C_L = 35 \text{ pF}$
	7	8	9	ns max	$V_S = 1.5 \text{ V}$; Figure 22
Break-Before-Make Time Delay (t_{BBM})	20			ns typ	$R_L = 50 \Omega$, $C_L = 35 \text{ pF}$
			5	ns min	$V_{S1} = V_{S2} = 1.5 \text{ V}$; Figure 22
Charge Injection	20			pC typ	$V_S = 1.25 \text{ V}$, $R_S = 0 \Omega$, $C_L = 1 \text{ nF}$; Figure 24
Off Isolation	-67			dB typ	$R_L = 50 \Omega$, $C_L = 5 \text{ pF}$, $f = 100 \text{ kHz}$; Figure 25
Channel-to-Channel Crosstalk	-75			dB typ	$R_L = 50 \Omega$, $C_L = 5 \text{ pF}$, $f = 100 \text{ kHz}$; Figure 27
Total Harmonic Distortion (THD + N)	0.022			%	$R_L = 32 \Omega$, $f = 20 \text{ Hz to } 20 \text{ kHz}$, $V_S = 1.5 \text{ V p-p}$
Insertion Loss	-0.06			dB typ	$R_L = 50 \Omega$, $C_L = 5 \text{ pF}$, $f = 100 \text{ kHz}$
-3 dB Bandwidth	33			MHz typ	$R_L = 50 \Omega$, $C_L = 5 \text{ pF}$; Figure 26
C_S (OFF)	25			pF typ	
C_D (OFF)	110			pF typ	
C_D, C_S (ON)	128			pF typ	
POWER REQUIREMENTS					
I_{DD}	0.003			μA typ	$V_{DD} = 2.7 \text{ V}$ Digital inputs = 0 V or 2.7 V
		1	4	μA max	

¹ Temperature range, Y version: -40°C to +125°C.

² Guaranteed by design, not subject to production test.

$V_{DD} = 1.65 \text{ V} \pm 1.95 \text{ V}$, $GND = 0 \text{ V}$, unless otherwise noted.¹

Table 3.

Parameter	-40°C to +85°C			Unit	Test Conditions/Comments
	+25°C	-40°C to +125°C			
ANALOG SWITCH					
Analog Signal Range			0 V to V_{DD}	V	
On Resistance (R_{ON})	1			Ω typ	$V_{DD} = 1.8 \text{ V}$; $V_S = 0 \text{ V to } V_{DD}$, $I_S = 10 \text{ mA}$
	1.4	2.2	2.2	Ω max	
	2.2	4	4	Ω max	$V_{DD} = 1.65 \text{ V}$, $V_S = 0 \text{ V to } V_{DD}$, $I_S = 10 \text{ mA}$; Figure 18
On Resistance Match between Channels (ΔR_{ON})	0.1			Ω typ	$V_{DD} = 1.65 \text{ V}$, $V_S = 0.7 \text{ V}$, $I_S = 10 \text{ mA}$
LEAKAGE CURRENTS					
Source Off Leakage I_S (OFF)	± 0.1			nA typ	$V_{DD} = 1.95 \text{ V}$ $V_S = 0.6 \text{ V}/1.35 \text{ V}$, $V_D = 1.35 \text{ V}/0.6 \text{ V}$; Figure 19
	± 2			nA max	
Drain Off Leakage I_D (OFF)	± 0.1			nA typ	$V_S = 0.6/1.35 \text{ V}$, $V_D = 1.35/0.6 \text{ V}$; Figure 19
	± 2			nA max	
Channel On Leakage I_D , I_S (ON)	± 0.1			nA typ	$V_S = V_D = 0.6 \text{ V or } 1.35 \text{ V}$; Figure 20
	± 2			nA max	
DIGITAL INPUTS					
Input High Voltage, V_{INH}			$0.65 V_{DD}$	V min	
Input Low Voltage, V_{INL}			$0.35 V_{DD}$	V max	
Input Current I_{INL} or I_{INH}	0.005			μA typ	$V_{IN} = V_{INL}$ or V_{INH}
			± 0.1	μA max	
C_{IN} , Digital Input Capacitance	4			pF typ	
DYNAMIC CHARACTERISTICS²					
$t_{TRANSITION}$	32			ns typ	$R_L = 50 \Omega$, $C_L = 35 \text{ pF}$
	40	42	44	ns max	$V_S = 1.5 \text{ V}/0 \text{ V}$; Figure 21
$t_{ON} \text{ ENABLE}$	34			ns typ	$R_L = 50 \Omega$, $C_L = 35 \text{ pF}$
	39	40	41	ns max	$V_S = 1.5 \Omega/0 \text{ V}$; Figure 22
$t_{OFF} \text{ ENABLE}$	8			ns typ	$R_L = 50 \Omega$, $C_L = 35 \text{ pF}$
	10	11	13	ns max	$V_S = 1.5 \text{ V}$; Figure 22
Break-Before-Make Time Delay (t_{BBM})	22			ns typ	$R_L = 50 \Omega$, $C_L = 35 \text{ pF}$
			5	ns min	$V_{S1} = V_{S2} = 1 \text{ V}$; Figure 22
Charge Injection	12			pC typ	$V_S = 1 \text{ V}$, $R_S = 0 \text{ V}$, $C_L = 1 \text{ nF}$; Figure 24
Off Isolation	-67			dB typ	$R_L = 50 \Omega$, $C_L = 5 \text{ pF}$, $f = 100 \text{ kHz}$; Figure 25
Channel-to-Channel Crosstalk	-75			dB typ	$R_L = 50 \Omega$, $C_L = 5 \text{ pF}$, $f = 100 \text{ kHz}$; Figure 27
Total Harmonic Distortion (THD + N)	0.14			%	$R_L = 32 \Omega$, $f = 20 \text{ Hz to } 20 \text{ kHz}$, $V_S = 1.2 \text{ V p-p}$
Insertion Loss	0.08			dB typ	$R_L = 50 \Omega$, $C_L = 5 \text{ pF}$, $f = 100 \text{ kHz}$
-3 dB Bandwidth	30			MHz typ	$R_L = 50 \Omega$, $C_L = 5 \text{ pF}$; Figure 26
C_S (OFF)	26			pF typ	
C_D (OFF)	115			pF typ	
C_D , C_S (ON)	130			pF typ	
POWER REQUIREMENTS					
I_{DD}	0.003			μA typ	$V_{DD} = 1.95 \text{ V}$ Digital inputs = 0 V or 1.95 V
		1.0	4	μA max	

¹ Temperature range, Y version: -40°C to +125°C.

² Guaranteed by design, not subject to production test.

ABSOLUTE MAXIMUM RATINGS

$T_A = 25^\circ\text{C}$, unless otherwise noted.

Table 4.

Parameter	Rating
V_{DD} to GND	-0.3 V to +4.6 V
Analog Inputs ¹	-0.3 V to $V_{DD} + 0.3$ V
Digital Inputs ¹	-0.3 V to +4.6 V or 10 mA, whichever occurs first
Peak Current, S or D	(Pulsed at 1 ms, 10% Duty Cycle Max)
3.3 V Operation	500 mA
2.5 V Operation	460 mA
1.8 V Operation	420 mA
Continuous Current, S or D	
3.3 V Operation	300 mA
2.5 V Operation	275 mA
1.8 V Operation	250 mA
Operating Temperature Range	
Automotive (Y Version)	-40°C to +125°C
Storage Temperature Range	-65°C to +150°C
Junction Temperature	150°C
MSOP Package	
θ_{JA} Thermal Impedance	206°C/W
θ_{JC} Thermal Impedance	44°C/W
Lead Temperature, Soldering	As per JEDEC J-STD-020

¹ Overvoltages at IN, S, or D are clamped by internal diodes. Current should be limited to the maximum ratings given.

Stresses above those listed under Absolute Maximum Ratings may cause permanent damage to the device. This is a stress rating only; functional operation of the device at these or any other conditions above those listed in the operational sections of this specification is not implied. Exposure to absolute maximum rating conditions for extended periods may affect device reliability. Only one absolute maximum rating may be applied at any one time.

Table 5. ADG804 Truth Table

A1	A0	EN	ON Switch
x	x	0	None
0	0	1	S1
0	1	1	S2
1	0	1	S3
1	1	1	S4

ESD CAUTION



ESD (electrostatic discharge) sensitive device. Charged devices and circuit boards can discharge without detection. Although this product features patented or proprietary protection circuitry, damage may occur on devices subjected to high energy ESD. Therefore, proper ESD precautions should be taken to avoid performance degradation or loss of functionality.

PIN CONFIGURATION

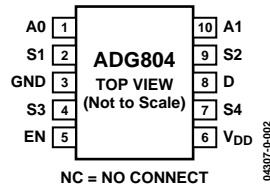

Figure 2. 10-Lead MSOP (RM-10)

Table 6. Terminology

V_{DD}	Most positive power supply potential.
I_{DD}	Positive supply current.
GND	Ground (0 V) reference.
S	Source terminal. May be an input or an output.
D	Drain terminal. May be an input or an output.
EN	Active high logic control input.
A0, A1	Logic control inputs. Used to select which source terminal, S1 to S4, is connected to the drain, D.
V_D, V_S	Analog voltage on terminals D, S.
R_{ON}	Ohmic resistance between D and S.
$R_{FLAT(ON)}$	Flatness is defined as the difference between the maximum and minimum value of on resistance as measured over the specified analog signal range.
ΔR_{ON}	On resistance match between any two channels.
$I_S(OFF)$	Source leakage current with the switch off.
$I_D(OFF)$	Drain leakage current with the switch off.
$I_D, I_S(ON)$	Channel leakage current with the switch on.
V_{INL}	Maximum input voltage for Logic 0.
V_{INH}	Minimum input voltage for Logic 1.
$I_{INL}(I_{INH})$	Input current of the digital input.
$C_S(OFF)$	Off switch source capacitance. Measured with reference to ground.
$C_D(OFF)$	Off switch drain capacitance. Measured with reference to ground.
$C_D, C_S(ON)$	On switch capacitance. Measured with reference to ground.
C_{IN}	Digital input capacitance.
$t_{ON}(EN)$	Delay time between the 50% and the 90% points of the digital input and switch on condition.
$t_{OFF}(EN)$	Delay time between the 50% and the 90% points of the digital input and switch off condition.
$t_{TRANSITION}$	Delay time between the 50% and the 90% points of the digital input and switch on condition when switching from one address state to the other.
t_{BBM}	On or off time measured between the 80% points of both switches when switching from one to another.
Charge Injection	A measure of the glitch impulse transferred from the digital input to the analog output during on-off switching.
Off Isolation	A measure of unwanted signal coupling through an off switch.
Crosstalk	A measure of unwanted signal which is coupled through from one channel to another as a result of parasitic capacitance.
-3 dB Bandwidth	The frequency at which the output is attenuated by 3 dB.
On Response	The frequency response of the on switch.
Insertion Loss	The loss due to the on resistance of the switch.
THD + N	The ratio of the harmonic amplitudes plus noise of a signal to the fundamental.

TYPICAL PERFORMANCE CHARACTERISTICS

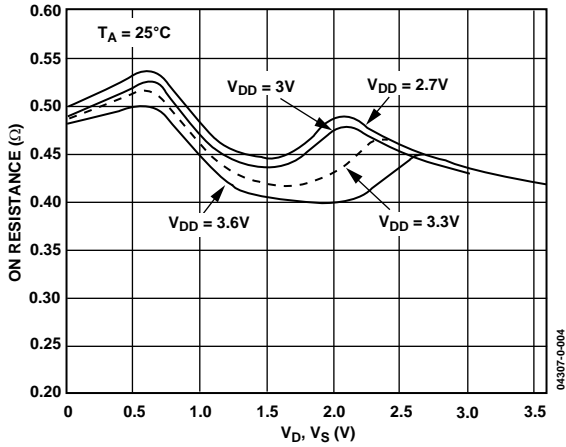

Figure 3. On Resistance vs. V_D (V_S) $V_{DD} = 2.7V$ to $3.6V$

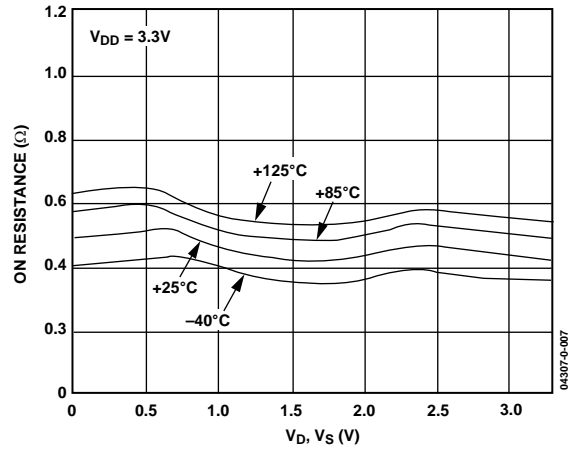

Figure 6. On Resistance vs. V_D (V_S) for Different Temperature, $V_{DD} = 3.3V$

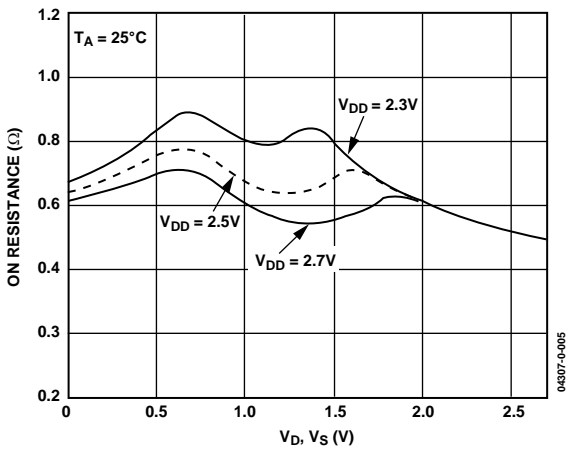

Figure 4. On Resistance vs. V_D (V_S) $V_{DD} = 2.5V \pm 0.2V$

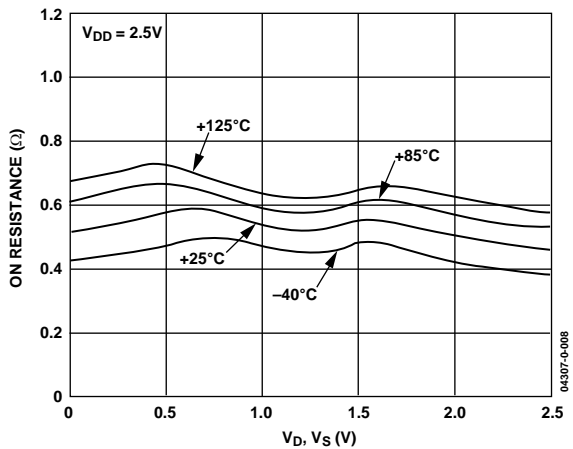

Figure 7. On Resistance vs. V_D (V_S) for Different Temperature, $V_{DD} = 2.5V$

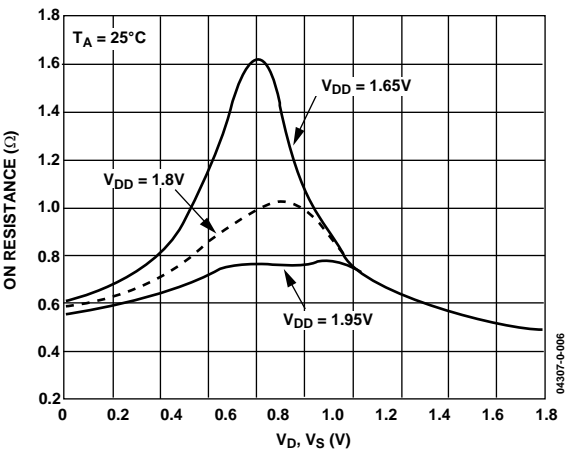

Figure 5. On Resistance vs. V_D (V_S) $V_{DD} = 1.8 \pm 0.15V$

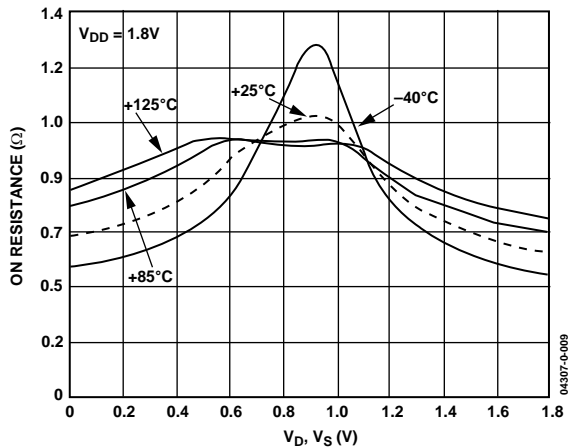

Figure 8. On Resistance vs. V_D (V_S) for Different Temperature, $V_{DD} = 1.8V$

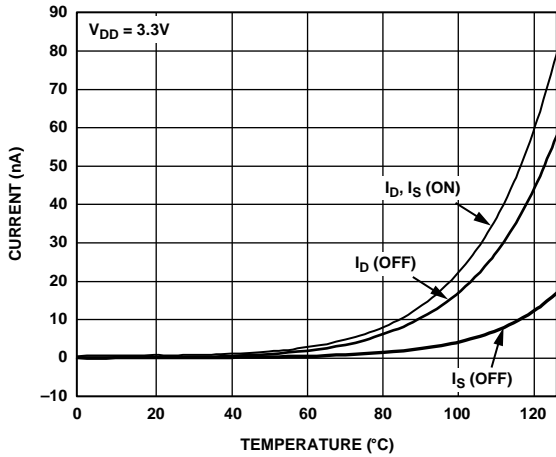

Figure 9. Leakage Current vs. Temperature, $V_{DD} = 3.3V$

04307-0-010

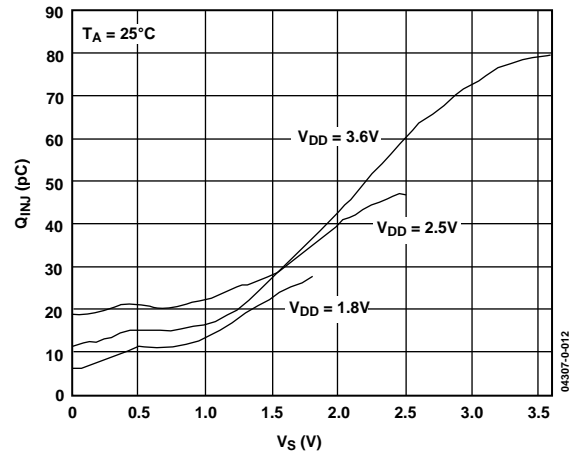

Figure 12. Charge Injection vs. Source Voltage, $V_{DD} = 1.8V$

04307-0-012

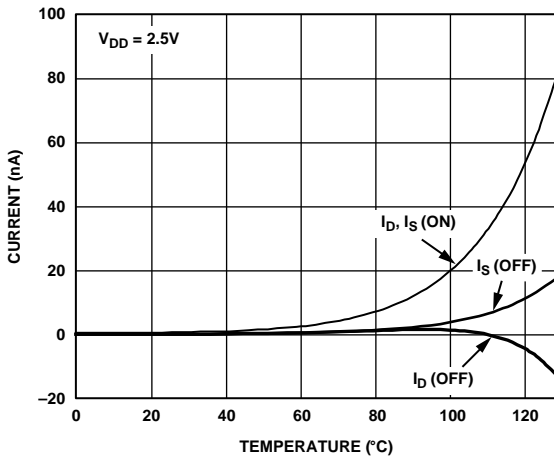

Figure 10. Leakage Current vs. Temperature, $V_{DD} = 2.5V$

04307-0-011

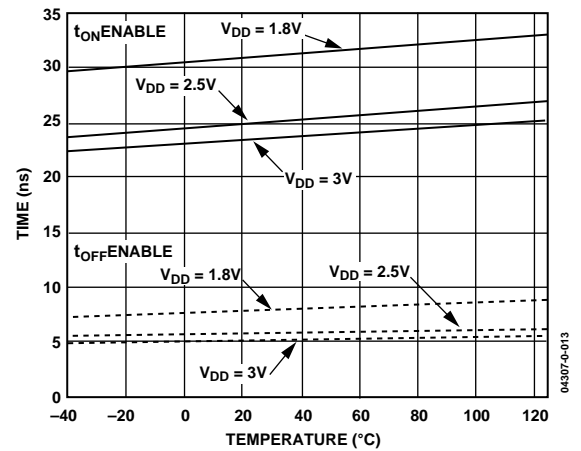

Figure 13. t_{ON}/t_{OFF} Times vs. Temperature

04307-0-013

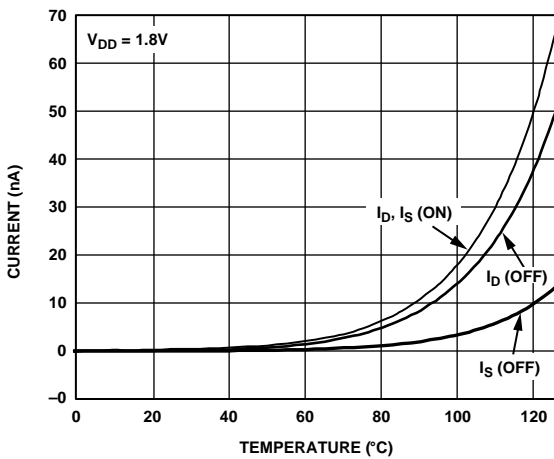

Figure 11. Leakage Current vs. Temperature, $V_{DD} = 1.8V$

04307-0-017

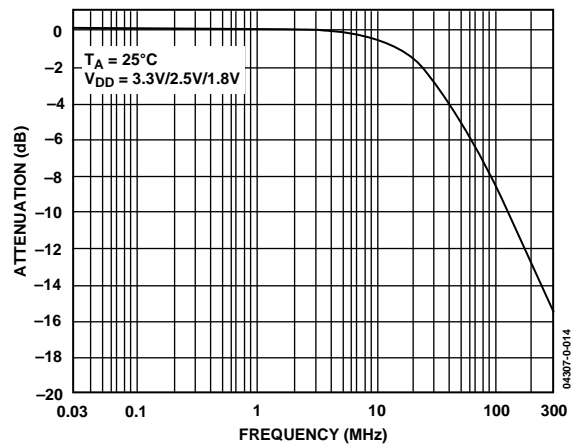

Figure 14. Bandwidth

04307-0-014

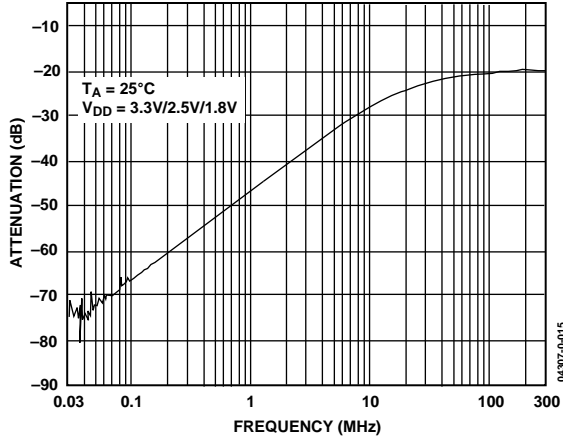

Figure 15. Off Isolation vs. Frequency

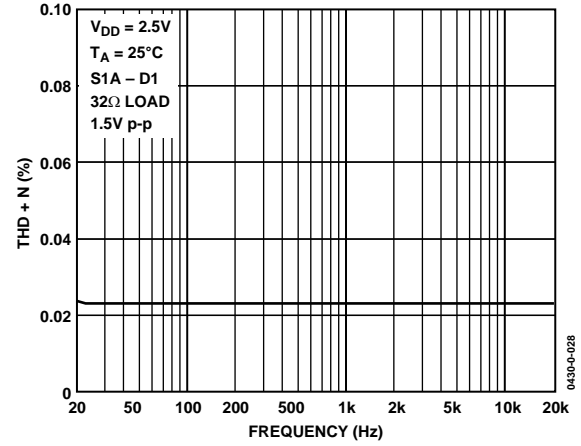

Figure 17. Total Harmonic Distortion + Noise

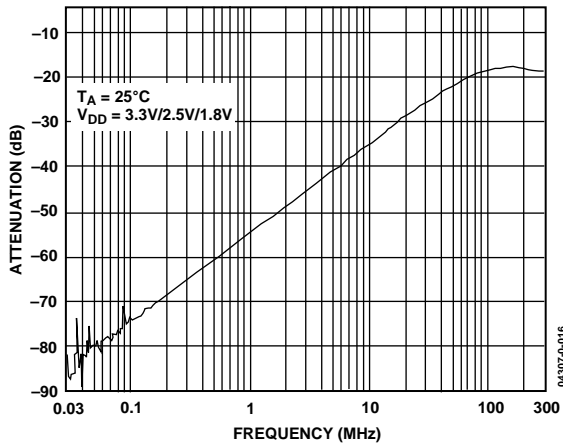

Figure 16. Crosstalk vs. Frequency

TEST CIRCUITS

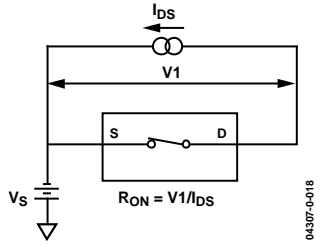

Figure 18. On Resistance

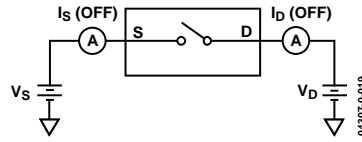

Figure 19. Off Leakage

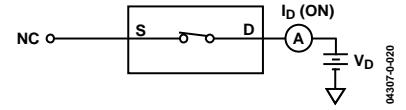

Figure 20. On Leakage

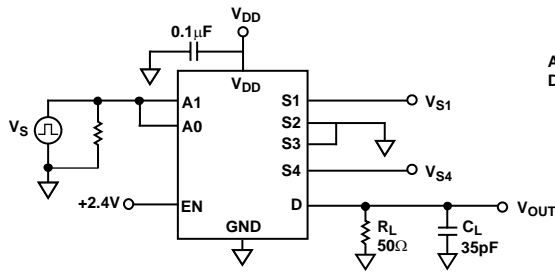

Figure 21. Switching Time of Multiplexer, $t_{TRANSITION}$

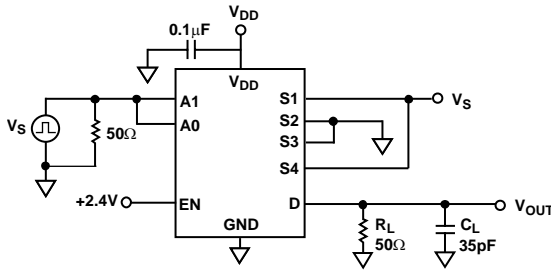
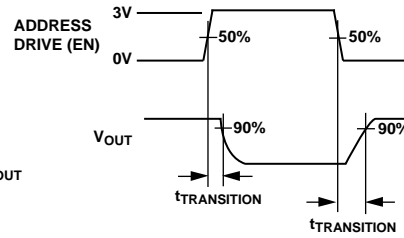

Figure 22. Break-Before-Make Time Delay, t_{BBM}

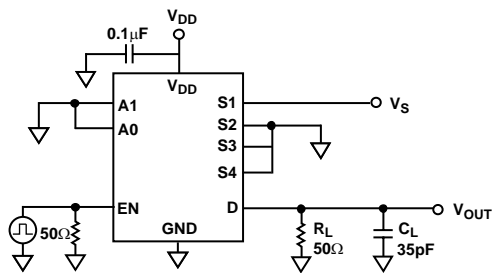
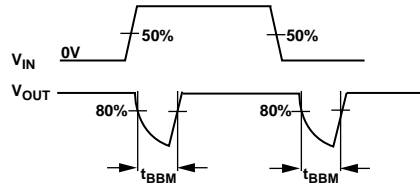
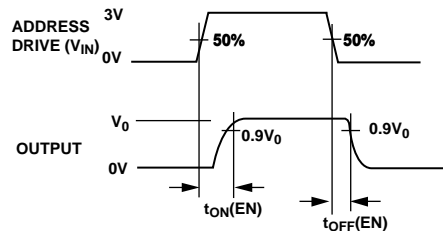

Figure 23. Enable Delay, $t_{ON}(EN)$, $t_{OFF}(EN)$



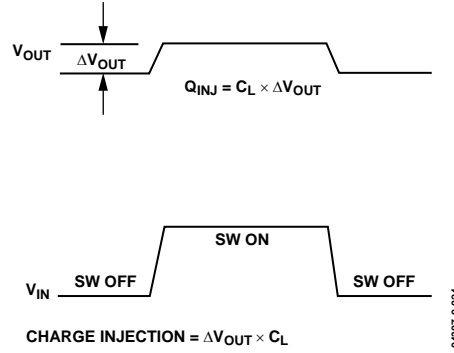
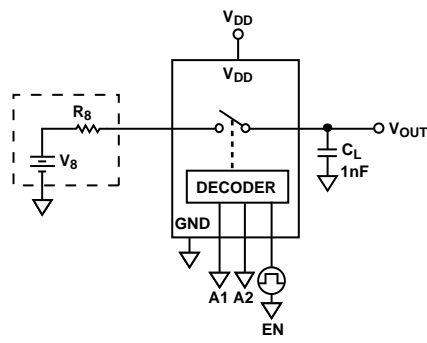
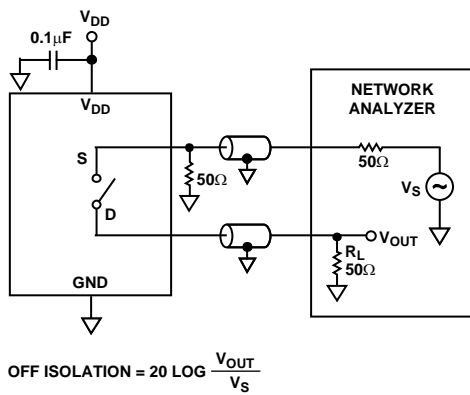
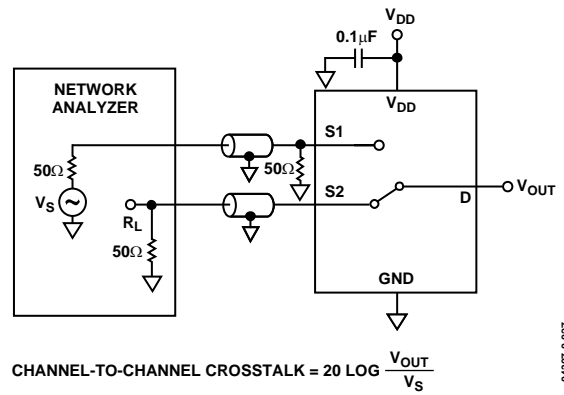

Figure 24. Charge Injection



$$\text{OFF ISOLATION} = 20 \text{ LOG } \frac{V_{\text{OUT}}}{V_{\text{S}}}$$

Figure 25. Off Isolation



$$\text{CHANNEL-TO-CHANNEL CROSSTALK} = 20 \text{ LOG } \frac{V_{\text{OUT}}}{V_{\text{S}}}$$

Figure 27. Channel-to-Channel Crosstalk

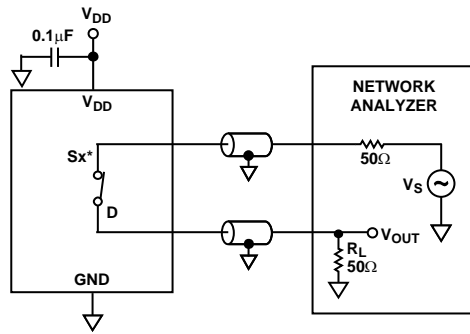

$$\text{OFF ISOLATION} = 20 \text{ LOG } \frac{V_{\text{OUT WITH SWITCH}}}{V_{\text{OUT WITHOUT SWITCH}}}$$

*UNUSED CHANNELS TERMINATED WITH 50Ω TO GROUND

Figure 26. Bandwidth

OUTLINE DIMENSIONS

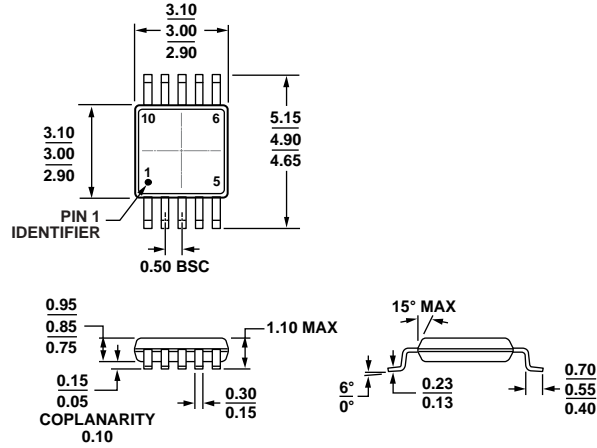

COMPLIANT TO JEDEC STANDARDS MO-187-BA

Figure 28. 10-Lead Mini Small Outline Package [MSOP] (RM-10)
Dimensions shown in millimeters

001709-A

ORDERING GUIDE

Model ¹	Temperature Range	Package Description	Package Option	Branding ^{2, 3}
ADG804YRM	-40°C to +125°C	10-Lead Mini Small Outline Package (MSOP)	RM-10	S1A
ADG804YRMZ	-40°C to +125°C	10-Lead Mini Small Outline Package (MSOP)	RM-10	S0N#
ADG804YRMZ-REEL	-40°C to +125°C	10-Lead Mini Small Outline Package (MSOP)	RM-10	S0N#
ADG804YRMZ-REEL7	-40°C to +125°C	10-Lead Mini Small Outline Package (MSOP)	RM-10	S0N#

¹ Z= RoHS compliant part.

² Branding on this package is limited to three characters due to space constraints.

³ # denotes lead-free product may be top or bottom marked

NOTES

NOTES

NOTES

Mouser Electronics

Authorized Distributor

Click to View Pricing, Inventory, Delivery & Lifecycle Information:

[Analog Devices Inc.:](#)

[ADG804YRM](#)