

# 11mm Rotary Encoder

## Type DP11 Series

### Type DP11 Series

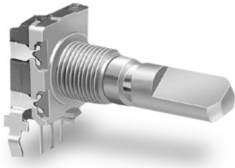

11mm Rotary incremental encoder for use in electronic equipment. Can be supplied with or without switch with customisation to standard options

### Key Features

- 11mm Rotary Encoder
- Incremental Type
- Push on Switch Option
- Various Shaft Lengths
- Pulse Options
- Detent Options

### Characteristics - Electrical

<b>Pulses:</b>	15, 20
<b>Contact Rating:</b>	10mA 5VDC
<b>Dielectric Strength:</b>	300VAC / 1mA, 1 minute
<b>Insulation Resistance (min):</b>	100M ohms at 250VAC
<b>Operating Speed (RPM):</b>	60 RPM
<b>Switch Power Rating (where fitted):</b>	16VDC, 3A (10mA Min)
<b>Switch Contact Resistance:</b>	100m ohm Max
<b>Electrical Travel:</b>	Continuous
<b>Rotational Noise:</b>	t2 = 2.0 ms max (see below)
<b>Chattering:</b>	t1 & t3 = 3.0 ms max (see below)

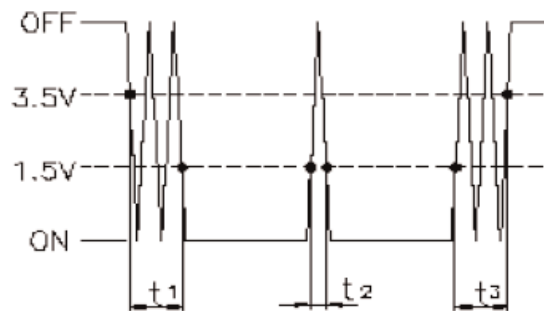

Code Off area V = 3.5V or more. Code on area V=1.5V or less

### Characteristics - Mechanical

<b>Total Mechanical Travel:</b>	Continuous
<b>Detents:</b>	0, 20, 30
<b>Switch Operating Force:</b>	612+/- 306gf (for 1.5mm Switch Travel 400+/- 200gf)
<b>Switch Travel:</b>	0.5mm (1.5mm available on request)
<b>Shaft Type:</b>	F – Flatted, K – Knurled, S – Slotted, P - Plain
<b>Shaft Length (from Mounting Surface):</b>	15, 20, 25, 30 (FMF)

### Characteristics - Environmental

<b>Operating Temperature</b>	-10 ~ +45 degrees C
<b>Rotational Life</b>	15,000 Cycles

### Output Signal Format

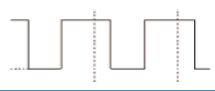
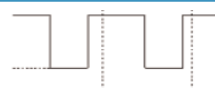
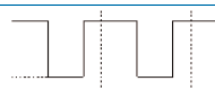
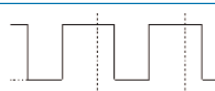
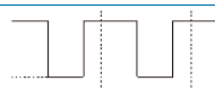
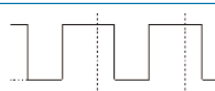
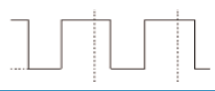
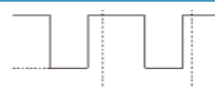
Shaft Rotational Direction	Signal	Format
Clockwise	A (Terminal A-C)	OFF  ON 
	B (Terminal B-C)	OFF  ON 
Anticlockwise	A (Terminal A-C)	OFF  ON 
	B (Terminal B-C)	OFF  ON 

# 11mm Rotary Encoder

## Type DP11 Series

### Dimensions DP11H



### DP11SH

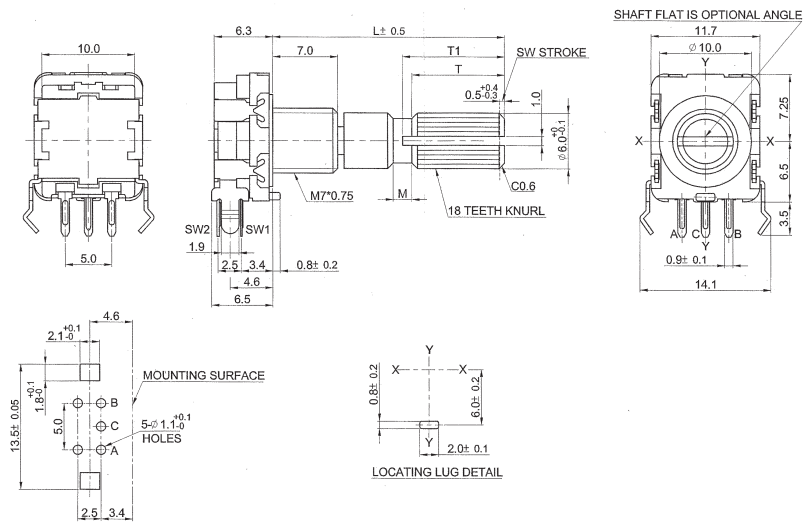

### Dimensions DP11V



### DP11SV



### Shaft Dimensions

Bush		5mm				7mm			
Shaft	Code								
K	L	15	20	25	30	15	20	25	30
	T1	7	7	11	14	6	7	11	14
	T	6	6	10	12	5	6	10	12
	M	2	2	2	4	1	1	2	4
F	L	15	20	25	30	15	20	25	30
	F	7	12	12	12	5	7	12	12

### How to Order

DP11	H	N	15	A	15	F
Common Part	Orientation	Detent	Pulses	Bush Details	Shaft Length	Shaft Style
DP11 – No Switch DP11S – With Switch	H - Horizontal V - Vertical	N - None 20 – 20 clicks 30 – 30 clicks	15 – 15 Pulses 20 – 20 Pulses	A – M7 x 5mm B – M7 x 7mm (standard)	15 – 15mm FMF 20 – 20mm FMF 25 – 25mm FMF 30 – 30mm FMF	K - Knurled F - Flatted S - Slotted P - Plain

# Mouser Electronics

Authorized Distributor

Click to View Pricing, Inventory, Delivery & Lifecycle Information:

[TE Connectivity:](#)

[DP11HN15B25K](#)