



Parameter	Rating	Units
Blocking Voltage	60	V_P
Load Current	600	mA_{rms} / mA_{DC}
Input Control Current	2	mA
On-Resistance (max)	1	Ω

Features

- Low Input Control Current: 2mA
- 3750V_{rms} Input/Output Isolation
- TTL/CMOS Compatible
- No Moving Parts
- High Reliability
- Arc-Free With No Snubbing Circuits
- No EMI/RFI Generation
- Small 8-Pin Package
- Machine Insertable, Wave Solderable
- Surface Mount Tape & Reel Version Available

Applications

- Instrumentation
 - Multiplexers
 - Data Acquisition
 - Electronic Switching
 - I/O Subsystems
- Meters (Watt-Hour, Water, Gas)
- Medical Equipment—Patient/Equipment Isolation
- Security
- Aerospace
- Industrial Controls
- Automotive

Description

The PAA132 Solid State Relay has two independent, single-pole, normally open (1-Form-A), relays in a single 8-pin package. It employs optically coupled MOSFET technology to provide 3750V_{rms} of input to output isolation.

Its optically coupled outputs, which use the patented OptoMOS architecture, are controlled by a highly efficient GaAIAs infrared LED.

By incorporating two independent, single-pole relays into a single 8-pin package, the PAA132 saves board space by providing a more compact design solution than two discrete single-pole relays in a variety of applications.

Approvals

- UL Recognized Component: File E76270
- CSA Certified Component: Certificate 1175739
- EN/IEC 60950-1 Certified Component:
TUV Certificate B 09 07 49410 004

Ordering Information

Part #	Description
PAA132	8-Pin DIP (50/Tube)
PAA132S	8-Pin Surface Mount (50/Tube)
PAA132STR	8-Pin Surface Mount (1,000/Reel)

Pin Configuration

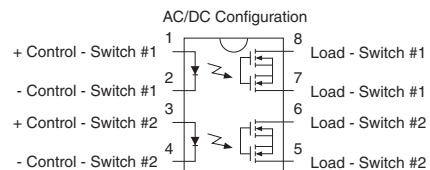

Switching Characteristics of Normally Open Devices

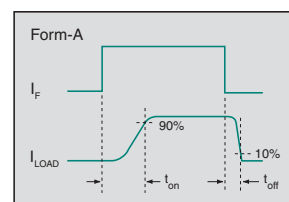

Absolute Maximum Ratings @ 25°C

Parameter	Ratings	Units
Blocking Voltage	60	V _P
Reverse Input Voltage	5	V
Input Control Current Peak (10ms)	50	mA
	1	A
Input Power Dissipation ¹	150	mW
Total Power Dissipation ²	800	mW
Isolation Voltage, Input to Output	3750	V _{rms}
Operational Temperature	-40 to +85	°C
Storage Temperature	-40 to +125	°C

Absolute Maximum Ratings are stress ratings. Stresses in excess of these ratings can cause permanent damage to the device. Functional operation of the device at conditions beyond those indicated in the operational sections of this data sheet is not implied.

¹ Derate linearly 1.33 mW / °C

² Derate linearly 6.67 mW / °C

Electrical Characteristics @ 25°C

Parameter	Conditions	Symbol	Min	Typ	Max	Units
Output Characteristics						
Load Current	-	I _L	-	-	600	mA _{rms} / mA _{DC}
Peak	t ≤ 10ms	I _{LPK}	-	-	±2	A _P
On-Resistance	I _L = 600mA	R _{ON}	-	0.85	1	Ω
Off-State Leakage Current	V _L = 60V _P	I _{LEAK}	-	-	1	μA
Switching Speeds						
Turn-On	I _F = 5mA, V _L = 10V	t _{on}	-	-	5	ms
Turn-Off		t _{off}	-	-	2	ms
Output Capacitance	V _L = 50V, f = 1MHz	C _{OUT}	-	25	-	pF
Input Characteristics						
Input Control Current to Activate	I _L = 600mA	I _F	-	-	2	mA
Input Control Current to Deactivate	-	I _F	0.2	-	-	mA
Input Voltage Drop	I _F = 10mA	V _F	0.9	1.2	1.4	V
Reverse Input Current	V _R = 5V	I _R	-	-	10	μA
Common Characteristics						
Capacitance Input to Output	-	C _{I/O}	-	3	-	pF

¹ If both poles operate, then the load current must be derated so that the package power dissipation value is not exceeded.

PERFORMANCE DATA @25°C (Unless Otherwise Noted)*

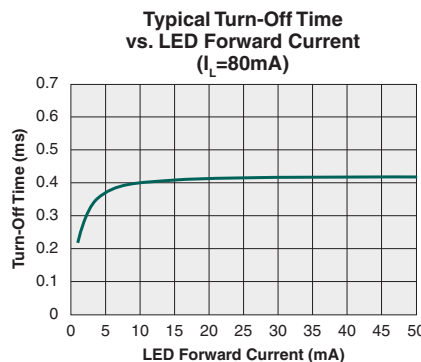
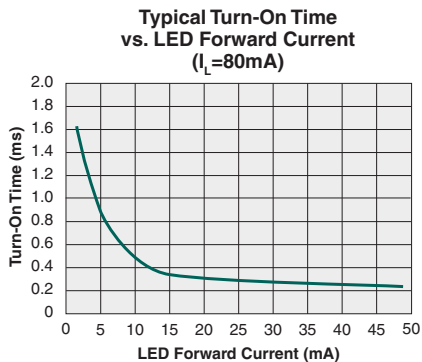
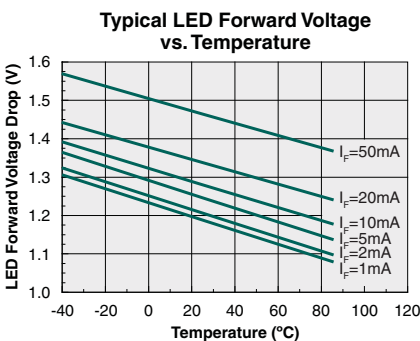
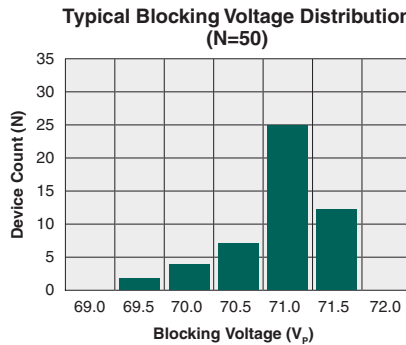
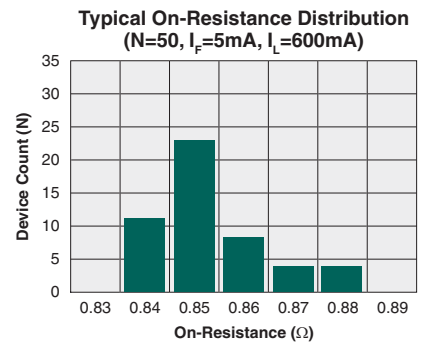
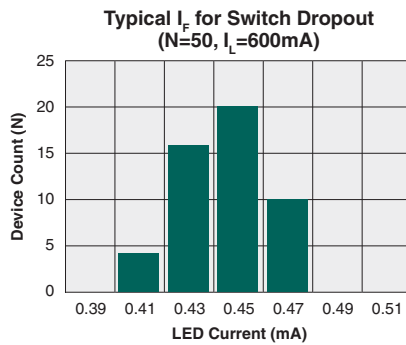
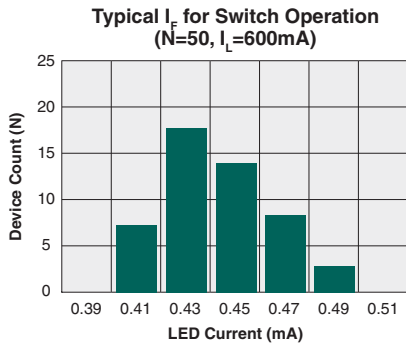
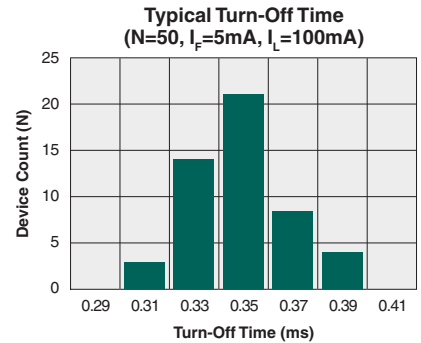
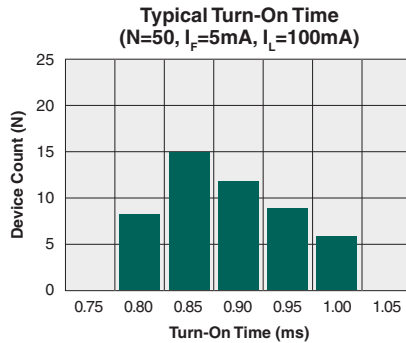
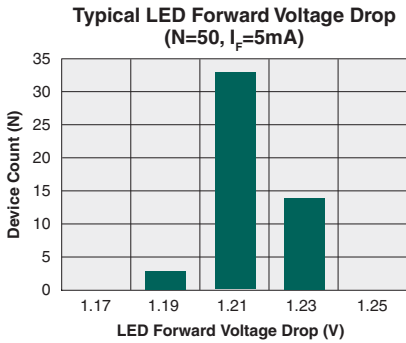

*The Performance data shown in the graphs above is typical of device performance. For guaranteed parameters not indicated in the written specifications, please contact our application department.

PERFORMANCE DATA @25°C (Unless Otherwise Noted)*

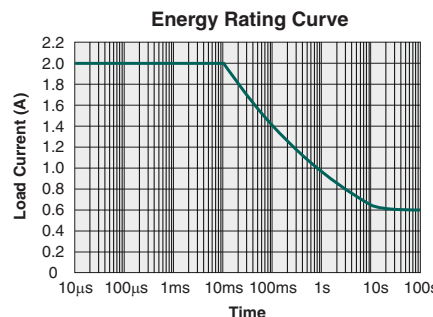
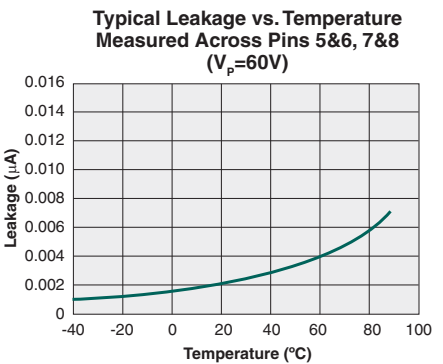
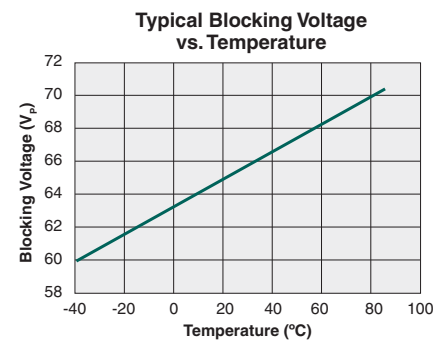
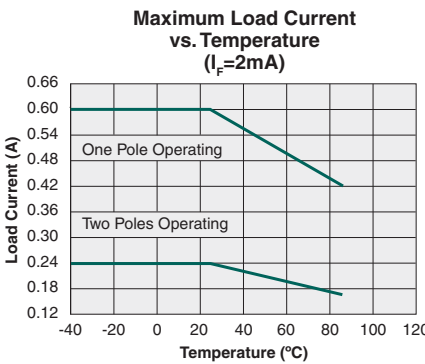
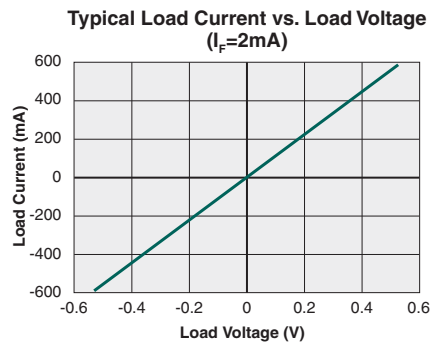
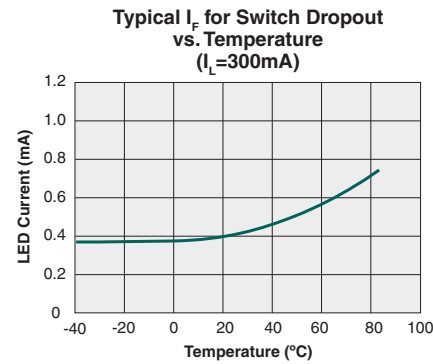
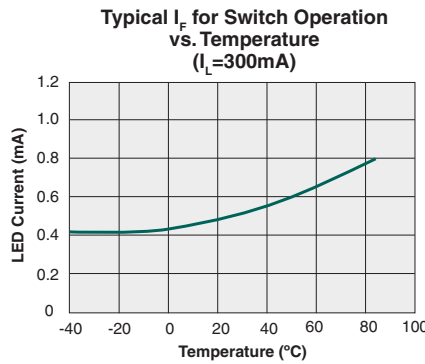
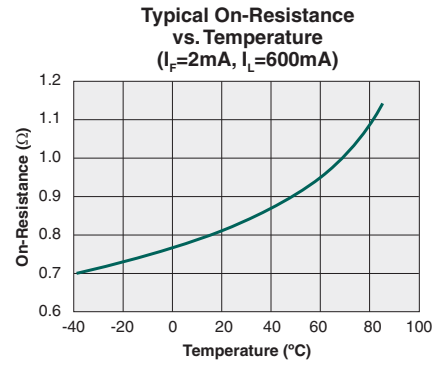
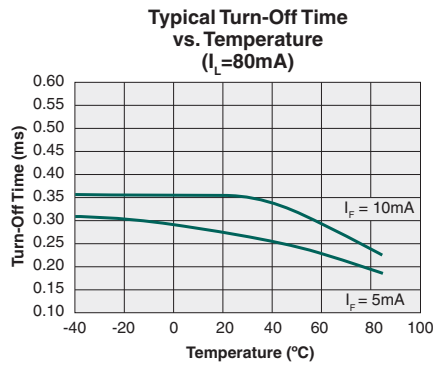
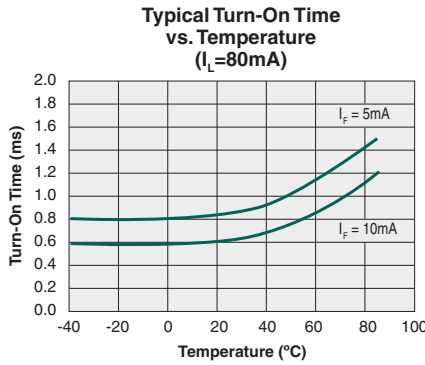

*The Performance data shown in the graphs above is typical of device performance. For guaranteed parameters not indicated in the written specifications, please contact our application department.

Manufacturing Information

Moisture Sensitivity



All plastic encapsulated semiconductor packages are susceptible to moisture ingress. IXYS Integrated Circuits Division classified all of its plastic encapsulated devices for moisture sensitivity according to the latest version of the joint industry standard, **IPC/JEDEC J-STD-020**, in force at the time of product evaluation. We test all of our products to the maximum conditions set forth in the standard, and guarantee proper operation of our devices when handled according to the limitations and information in that standard as well as to any limitations set forth in the information or standards referenced below.

Failure to adhere to the warnings or limitations as established by the listed specifications could result in reduced product performance, reduction of operable life, and/or reduction of overall reliability.

This product carries a **Moisture Sensitivity Level (MSL) rating** as shown below, and should be handled according to the requirements of the latest version of the joint industry standard **IPC/JEDEC J-STD-033**.

Device	Moisture Sensitivity Level (MSL) Rating
PAA132 / PAA132S	MSL 1

ESD Sensitivity



This product is **ESD Sensitive**, and should be handled according to the industry standard **JESD-625**.

Reflow Profile

This product has a maximum body temperature and time rating as shown below. All other guidelines of **J-STD-020** must be observed.

Device	Maximum Temperature x Time
PAA132 / PAA132S	250°C for 30 seconds

Board Wash

IXYS Integrated Circuits Division recommends the use of no-clean flux formulations. However, board washing to remove flux residue is acceptable. Since IXYS Integrated Circuits Division employs the use of silicone coating as an optical waveguide in many of its optically isolated products, the use of a short drying bake could be necessary if a wash is used after solder reflow processes. Chlorine- or Fluorine-based solvents or fluxes should not be used. Cleaning methods that employ ultrasonic energy should not be used.



Mechanical Dimensions

PAA132

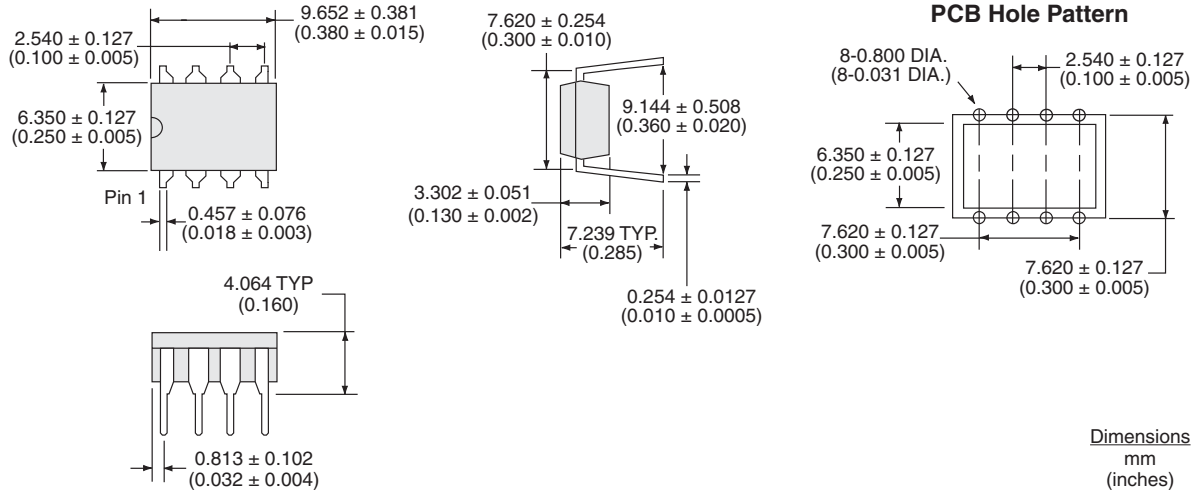

PAA132S

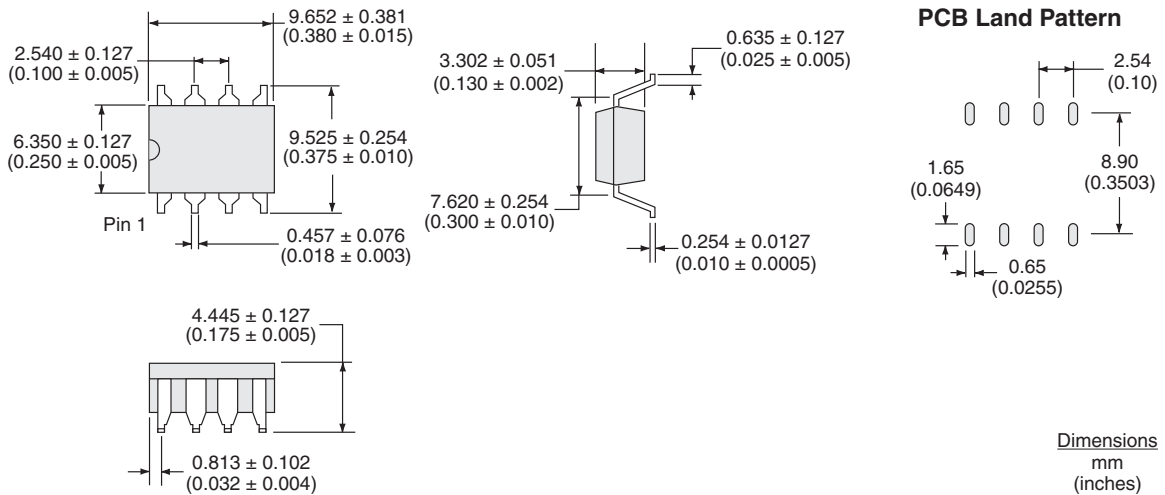

PAA132STR Tape & Reel

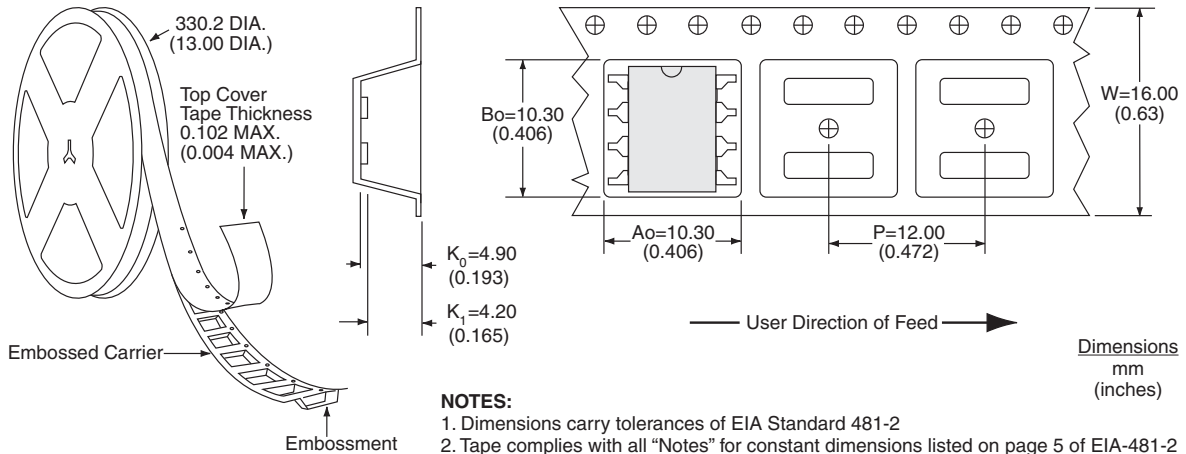

For additional information please visit our website at: www.ixysic.com

IXYS Integrated Circuits Division makes no representations or warranties with respect to the accuracy or completeness of the contents of this publication and reserves the right to make changes to specifications and product descriptions at any time without notice. Neither circuit patent licenses nor indemnity are expressed or implied. Except as set forth in IXYS Integrated Circuits Division's Standard Terms and Conditions of Sale, IXYS Integrated Circuits Division assumes no liability whatsoever, and disclaims any express or implied warranty, relating to its products including, but not limited to, the implied warranty of merchantability, fitness for a particular purpose, or infringement of any intellectual property right.

The products described in this document are not designed, intended, authorized or warranted for use as components in systems intended for surgical implant into the body, or in other applications intended to support or sustain life, or where malfunction of IXYS Integrated Circuits Division's product may result in direct physical harm, injury, or death to a person or severe property or environmental damage. IXYS Integrated Circuits Division reserves the right to discontinue or make changes to its products at any time without notice.

Mouser Electronics

Authorized Distributor

Click to View Pricing, Inventory, Delivery & Lifecycle Information:

[IXYS:](#)

[PAA132S](#) [PAA132](#) [PAA132STR](#)