



80×80×25 mm

San Cooler 80 9A type

General Specifications

- Material Frame: Plastic (Flammability: UL 94V-0), Impeller: Plastic (Flammability: UL 94V-0)
- Expected life See the table below. (L10 life: 90% survival rate for continuous operation in free air at 60°C, rated voltage)
- Motor protection function Locked rotor burnout protection, Reverse polarity protection
For details, please refer to p. 547.
- Dielectric strength 50/60 Hz, 500 VAC, for 1 minute (between lead wire conductors and frame)
- Insulation resistance 10 MΩ or more with a 500 VDC megger (between lead wire conductors and frame)
- Sound pressure level (SPL) At 1 m away from the air inlet
- Storage temperature -30 to +70°C (Non-condensing)
- Lead wire ⊕Red ⊖Black or Blue (Sensor) Yellow
- Mass 90 g

Specifications

The models listed below **have ribs and pulse sensors**. For models without ribs, append "1" to the end of model numbers.

Model no.	Rated voltage [V]	Operating voltage range [V]	Rated current [A]	Rated input [W]	Rated speed [min ⁻¹]	Max. airflow [m ³ /min] [CFM]	Max. static pressure [Pa] [inchH ₂ O]	SPL [dB (A)]	Operating temperature [°C]	Expected life [h]
9A0812G401	12	6 to 13.2	0.38	4.56	4500	1.5 53.0	80.3 0.323	40	-20 to +60	30000/60°C
9A0812S401		6 to 13.8	0.18	2.16	3400	1.2 42.4	48 0.193	34		
9A0812H401			0.13	1.56	2900	1.03 36.4	35.3 0.142	29		
9A0812F401			0.11	1.32	2600	0.92 32.5	28.4 0.114	26		
9A0812M401			0.09	1.08	2350	0.83 29.3	22.5 0.09	23		
9A0812L401			0.06	0.72	1850	0.65 23.0	14.7 0.059	20		
9A0824G401	24	12 to 26.4	0.21	5.04	4500	1.5 53.0	80.3 0.323	40	-20 to +60	30000/60°C
9A0824S401		12 to 27.6	0.1	2.4	3400	1.2 42.4	48 0.193	34		
9A0824H401			0.07	1.68	2900	1.03 36.4	35.3 0.142	29		
9A0824F401			0.06	1.44	2600	0.92 32.5	28.4 0.114	26		
9A0824M401			0.05	1.2	2350	0.83 29.3	22.5 0.09	23		
9A0824L401			0.04	0.96	1850	0.65 23.0	14.7 0.059	20		

The following sensor and control options are available for selection.

Available for all models. **Without sensor** **Lock sensor**

Differs according to the model. Refer to the table on pp. 565 to 566. **PWM control**

Airflow - Static Pressure Characteristics

9A0812G401 With pulse sensor

Operating voltage range

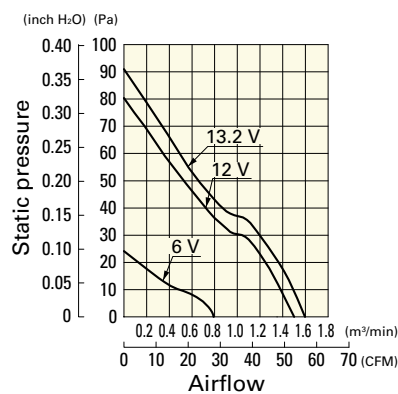

9A0812S401 With pulse sensor

Operating voltage range

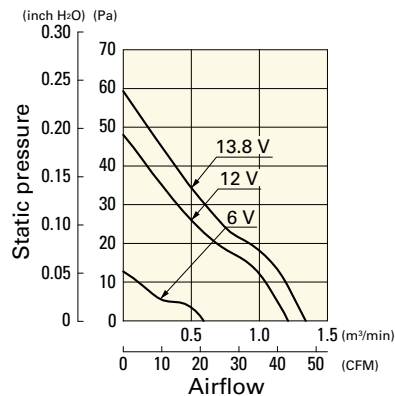

9A0812H401 With pulse sensor

Operating voltage range

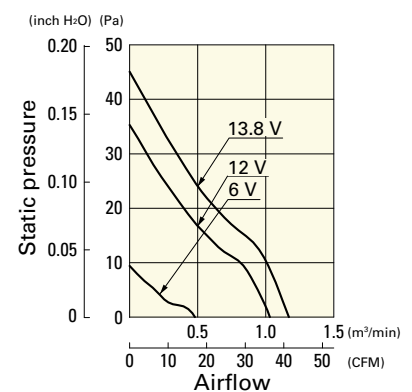

Airflow - Static Pressure Characteristics

9A0812F401 With pulse sensor

Operating voltage range

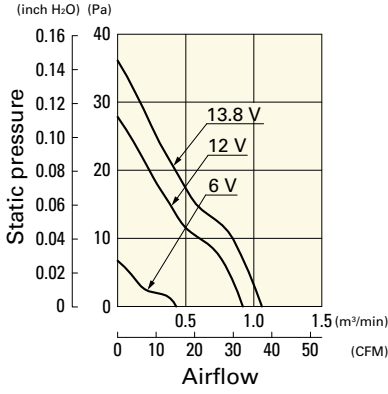

9A0812M401 With pulse sensor

Operating voltage range

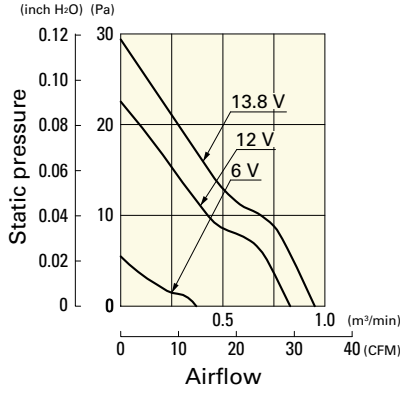

9A0812L401 With pulse sensor

Operating voltage range

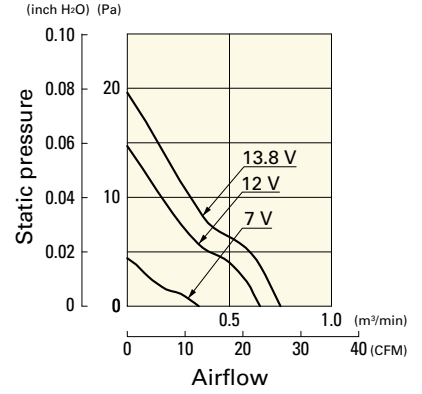

9A0824G401 With pulse sensor

Operating voltage range

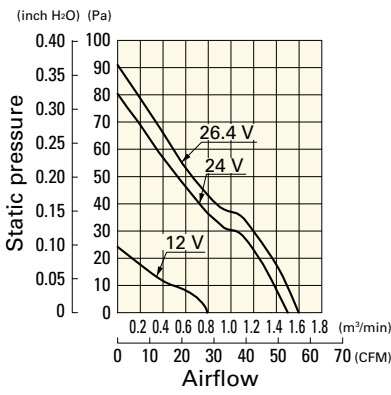

9A0824S401 With pulse sensor

Operating voltage range

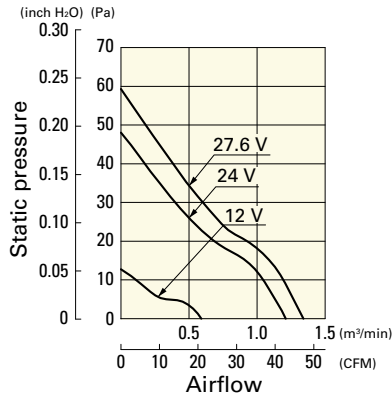

9A0824H401 With pulse sensor

Operating voltage range

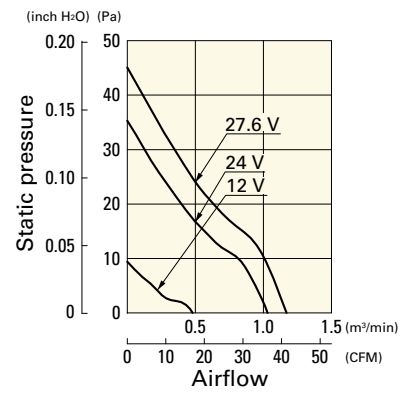

9A0824F401 With pulse sensor

Operating voltage range

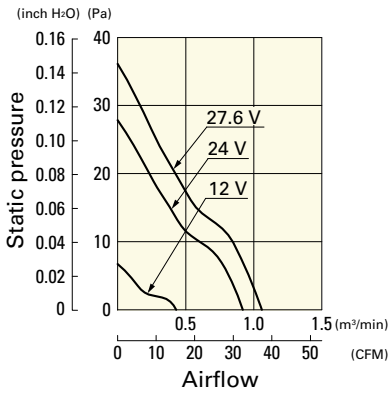

9A0824M401 With pulse sensor

Operating voltage range

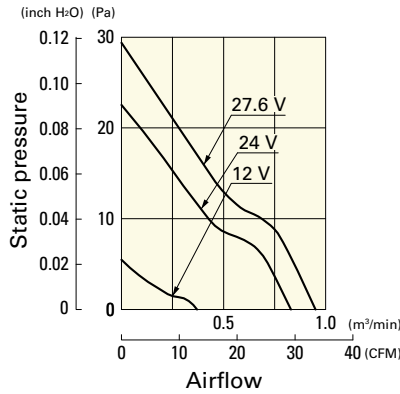

9A0824L401 With pulse sensor

Operating voltage range

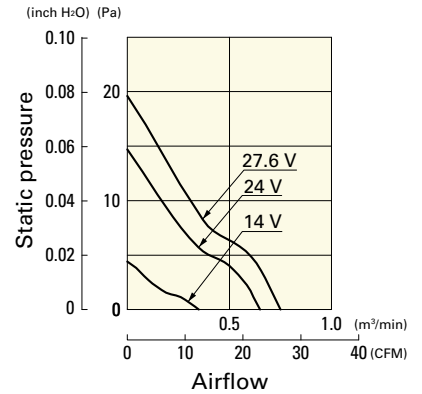

Dimensions (unit: mm) (With ribs)

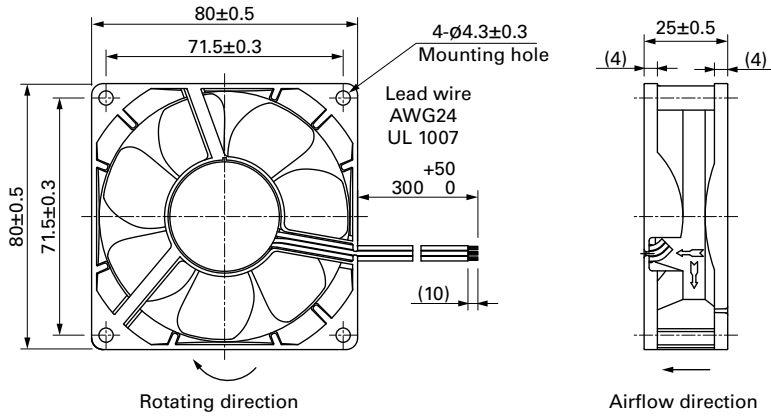

Reference Dimensions of Mounting Holes and Vent Opening (unit: mm)

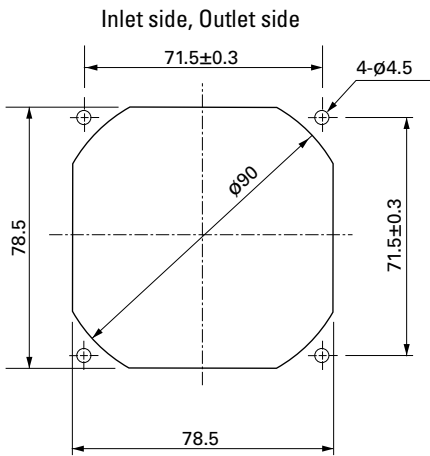

Options

Finger guards

page: p. 532

Model no.: 109-049E, 109-049H, 109-049C

Resin finger guards

page: p. 539

Model no.: 109-1002G

Resin filter kits

page: p. 540

Model no.: 109-1002F13 (13PPI), 109-1002F20 (20PPI),
109-1002F30 (30PPI), 109-1002F40 (40PPI)

Mouser Electronics

Authorized Distributor

Click to View Pricing, Inventory, Delivery & Lifecycle Information:

Sanyo Denki:

[9A0812G4011](#) [9A0812S401](#) [9A0824H4011](#) [9A0824S4011](#) [9AH0812P4H04](#) [9A0812F401](#) [9A0824G402](#)
[9A0812H4021](#) [9A0812H4011](#) [9A0812S4011](#) [9A0812G401](#) [9A0824H401](#) [9A0824S401](#) [9A0812H401](#) [9A0824G4011](#)
[9A0824L401](#) [9A0824G401](#) [9A0812M401](#) [9A0812L4011](#) [9A0812F4011](#) [9A0812L401](#) [9A0824L4011](#) [9A0824F401](#)
[9A0824F4011](#) [9A0824M4011](#) [9A0824M401](#) [9A0812M4011](#) [9A0812G4D011](#) [9A0812H402](#) [9A0812S402](#)
[9A0824G4D01](#) [9A0824F4D011](#) [9A0812A4021](#) [9A0824L402](#) [9A0824M402](#) [9A0824S4021](#) [9A0824H4D01](#)
[9A0812F4D011](#) [9A0812L4D011](#) [9A0812M402](#) [9A0824H4021](#) [9A0812G402](#) [9A0824H402](#) [9A0824H4D011](#)
[9A0824S402](#) [9A0812E4D01](#) [9A0824F402](#) [9A0824L4021](#) [9A0824G4D011](#) [9A0812A402](#) [9A0824F4D01](#)
[9A0824L4D011](#) [9A0824M4021](#) [9A0812L402](#) [9A0824M4D011](#) [9A0812M4D01](#) [9A0812M4D011](#) [9A0812A4D011](#)
[9A0812L4D01](#) [9A0812A4D01](#) [9A0812S4D01](#) [9A0812H4D011](#) [9A0812L4021](#) [9A0824G4021](#) [9A0812F4021](#)
[9A0812A4011](#) [9A0824S4D01](#) [9A0824M4D01](#) [9A0824F4021](#) [9A0812S4021](#) [9A0812F402](#) [9A0812M4021](#)
[9A0812E4D011](#) [9A0812H4D01](#) [9A0824L4D01](#) [9A0812S4D011](#) [9A0824S4D011](#) [9A0812F4D01](#) [9A0812G4D01](#)
[9A0812E4021](#) [9A0812G4021](#) [9AH0812P4G011](#) [9A0824A401](#) [9A0824A4011](#) [9A0824A402](#) [9A0824A4021](#)
[9A0824E401](#) [9A0824E4011](#) [9A0824E402](#) [9A0824E4021](#) [9AH0812P4G04](#)