

# NLSV2T244

## 2-Bit Dual-Supply Non-Inverting Level Translator

The NLSV2T244 is a 2-bit configurable dual-supply voltage level translator. The input  $A_n$  and output  $B_n$  ports are designed to track two different power supply rails,  $V_{CCA}$  and  $V_{CCB}$  respectively. Both supply rails are configurable from 0.9 V to 4.5 V allowing universal low-voltage translation from the input  $A_n$  to the output  $B_n$  port.

### Features

- Wide  $V_{CCA}$  and  $V_{CCB}$  Operating Range: 0.9 V to 4.5 V
- High-Speed w/ Balanced Propagation Delay
- Inputs and Outputs have OVT Protection to 4.5 V
- Non-preferential  $V_{CCA}$  and  $V_{CCB}$  Sequencing
- Outputs at 3-State until Active  $V_{CC}$  is Reached
- Power-Off Protection
- Outputs Switch to 3-State with  $V_{CCB}$  at GND
- Small Packaging: UDFN8, SO-8, Micro8
- These Devices are Pb-Free, Halogen Free/BFR Free and are RoHS Compliant

### Typical Applications

- Mobile Phones, PDAs, Other Portable Devices

### Important Information

- ESD Protection for All Pins:  
HBM (Human Body Model) > 5000 V



ON Semiconductor®

[www.onsemi.com](http://www.onsemi.com)

### MARKING DIAGRAMS



**UDFN8**  
**MU SUFFIX**  
**CASE 517AJ**

UP = Specific Device Code  
M = Date Code  
▪ = Pb-Free Package

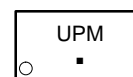

**SO-8**  
**D SUFFIX**  
**CASE 751**

A = Assembly Location  
L = Wafer Lot  
Y = Year  
W = Work Week  
▪ = Pb-Free Package

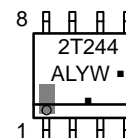

**Micro8**  
**DM SUFFIX**  
**CASE 846A**

A = Assembly Location  
Y = Year  
W = Work Week  
▪ = Pb-Free Package

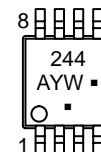

### ORDERING INFORMATION

Device	Package	Shipping†
NLSV2T244MUTAG	UDFN8 (Pb-Free)	3000 / Tape & Reel
NLSV2T244DR2G	SO-8 (Pb-Free)	2500 / Tape & Reel
NLSV2T244DMR2G	Micro8 (Pb-Free)	4000 / Tape & Reel

†For information on tape and reel specifications, including part orientation and tape sizes, please refer to our Tape and Reel Packaging Specification Brochure, BRD8011/D.

# NLSV2T244

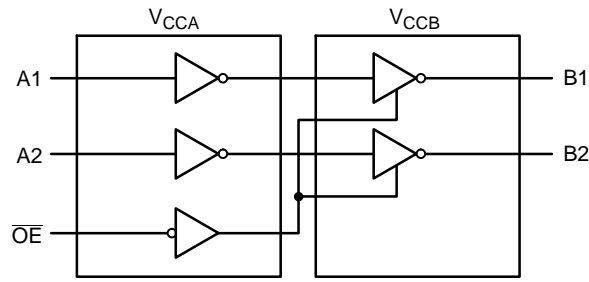
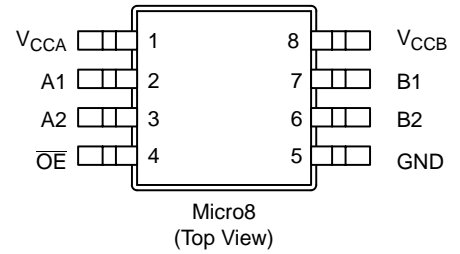
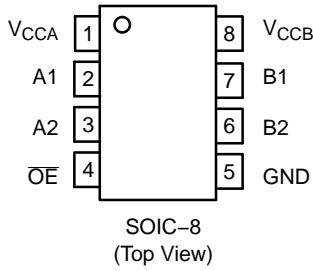
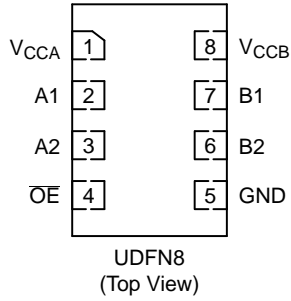

Figure 1. Logic Diagram

## PIN ASSIGNMENTS



## PIN ASSIGNMENT

PIN	FUNCTION
V <sub>CCA</sub>	Input Port DC Power Supply
V <sub>CCB</sub>	Output Port DC Power Supply
GND	Ground
A <sub>n</sub>	Input Port
B <sub>n</sub>	Output Port
OE	Output Enable

## TRUTH TABLE

Inputs		Outputs
OE	A <sub>n</sub>	B <sub>n</sub>
L	L	L
L	H	H
H	X	3-State

# NLSV2T244

## MAXIMUM RATINGS

Symbol	Rating	Value	Condition	Unit
$V_{CCA}, V_{CCB}$	DC Supply Voltage	-0.5 to +5.5		V
$V_I$	DC Input Voltage $A_n$	-0.5 to +5.5		V
$V_C$	Control Input $\overline{OE}$	-0.5 to +5.5		V
$V_O$	DC Output Voltage (Power Down) $B_n$	-0.5 to +5.5	$V_{CCA} = V_{CCB} = 0$	V
	(Active Mode) $B_n$	-0.5 to +5.5		V
	(Tri-State Mode) $B_n$	-0.5 to +5.5		V
$I_{IK}$	DC Input Diode Current	-20	$V_I < \text{GND}$	mA
$I_{OK}$	DC Output Diode Current	-50	$V_O < \text{GND}$	mA
$I_O$	DC Output Source/Sink Current	$\pm 50$		mA
$I_{CCA}, I_{CCB}$	DC Supply Current Per Supply Pin	$\pm 100$		mA
$I_{GND}$	DC Ground Current per Ground Pin	$\pm 100$		mA
$T_{STG}$	Storage Temperature	-65 to +150		$^{\circ}\text{C}$

Stresses exceeding those listed in the Maximum Ratings table may damage the device. If any of these limits are exceeded, device functionality should not be assumed, damage may occur and reliability may be affected.

## RECOMMENDED OPERATING CONDITIONS

Symbol	Parameter	Min	Max	Unit
$V_{CCA}, V_{CCB}$	Positive DC Supply Voltage	0.9	4.5	V
$V_I$	Bus Input Voltage	GND	4.5	V
$V_C$	Control Input $\overline{OE}$	GND	4.5	V
$V_{IO}$	Bus Output Voltage (Power Down Mode) $B_n$	GND	4.5	V
	(Active Mode) $B_n$	GND	$V_{CCB}$	V
	(Tri-State Mode) $B_n$	GND	4.5	V
$T_A$	Operating Temperature Range	-40	+85	$^{\circ}\text{C}$
$\Delta t / \Delta V$	Input Transition Rise or Rate $V_I$ , from 30% to 70% of $V_{CC}$ ; $V_{CC} = 3.3 \text{ V} \pm 0.3 \text{ V}$	0	10	nS

Functional operation above the stresses listed in the Recommended Operating Ranges is not implied. Extended exposure to stresses beyond the Recommended Operating Ranges limits may affect device reliability.

# NLSV2T244

## DC ELECTRICAL CHARACTERISTICS

Symbol	Parameter	Test Conditions	V <sub>CCA</sub> (V)	V <sub>CCB</sub> (V)	-40°C to +85°C		Unit
					Min	Max	
V <sub>IH</sub>	Input HIGH Voltage (An, OE)		3.6 – 4.5	0.9 – 4.5	2.2	–	V
			2.7 – 3.6		2.0	–	
			2.3 – 2.7		1.6	–	
			1.4 – 2.3		0.65 * V <sub>CCA</sub>	–	
			0.9 – 1.4		0.9 * V <sub>CCA</sub>	–	
V <sub>IL</sub>	Input LOW Voltage (An, OE)		3.6 – 4.5	0.9 – 4.5	–	0.8	V
			2.7 – 3.6		–	0.8	
			2.3 – 2.7		–	0.7	
			1.4 – 2.3		–	0.35 * V <sub>CCA</sub>	
			0.9 – 1.4		–	0.1 * V <sub>CCA</sub>	
V <sub>OH</sub>	Output HIGH Voltage	I <sub>OH</sub> = -100 μA; V <sub>I</sub> = V <sub>IH</sub>	0.9 – 4.5	0.9 – 4.5	V <sub>CCB</sub> - 0.2	–	V
		I <sub>OH</sub> = -0.5 mA; V <sub>I</sub> = V <sub>IH</sub>	0.9	0.9	0.75 * V <sub>CCB</sub>	–	
		I <sub>OH</sub> = -2 mA; V <sub>I</sub> = V <sub>IH</sub>	1.4	1.4	1.05	–	
		I <sub>OH</sub> = -6 mA; V <sub>I</sub> = V <sub>IH</sub>	1.65	1.65	1.25	–	
			2.3	2.3	2.0	–	
		I <sub>OH</sub> = -12 mA; V <sub>I</sub> = V <sub>IH</sub>	2.3	2.3	1.8	–	
			2.7	2.7	2.2	–	
		I <sub>OH</sub> = -18 mA; V <sub>I</sub> = V <sub>IH</sub>	2.3	2.3	1.7	–	
3.0	3.0		2.4	–			
V <sub>OL</sub>	Output LOW Voltage	I <sub>OL</sub> = 100 μA; V <sub>I</sub> = V <sub>IL</sub>	0.9 – 4.5	0.9 – 4.5	–	0.2	V
		I <sub>OL</sub> = 0.5 mA; V <sub>I</sub> = V <sub>IL</sub>	1.1	1.1	–	0.3	
		I <sub>OL</sub> = 2 mA; V <sub>I</sub> = V <sub>IL</sub>	1.4	1.4	–	0.35	
		I <sub>OL</sub> = 6 mA; V <sub>I</sub> = V <sub>IL</sub>	1.65	1.65	–	0.3	
			2.3	2.3	–	0.4	
		I <sub>OL</sub> = 12 mA; V <sub>I</sub> = V <sub>IL</sub>	2.7	2.7	–	0.4	
			2.3	2.3	–	0.6	
		I <sub>OL</sub> = 18 mA; V <sub>I</sub> = V <sub>IL</sub>	3.0	3.0	–	0.4	
3.0	3.0		–	0.55			
I <sub>I</sub>	Input Leakage Current	V <sub>I</sub> = V <sub>CCA</sub> or GND	0.9 – 4.5	0.9 – 4.5	-1.0	1.0	μA
I <sub>OFF</sub>	Power-Off Leakage Current	OE = 0 V	0 0.9 – 4.5	0.9 – 4.5 0	-1.0 -1.0	1.0 1.0	μA
I <sub>CCA</sub>	Quiescent Supply Current	V <sub>I</sub> = V <sub>CCA</sub> or GND; I <sub>O</sub> = 0, V <sub>CCA</sub> = V <sub>CCB</sub>	0.9 – 4.5	0.9 – 4.5	–	1.0	μA
I <sub>CCB</sub>	Quiescent Supply Current	V <sub>I</sub> = V <sub>CCA</sub> or GND; I <sub>O</sub> = 0, V <sub>CCA</sub> = V <sub>CCB</sub>	0.9 – 4.5	0.9 – 4.5	–	1.0	μA
I <sub>CCA</sub> + I <sub>CCB</sub>	Quiescent Supply Current	V <sub>I</sub> = V <sub>CCA</sub> or GND; I <sub>O</sub> = 0, V <sub>CCA</sub> = V <sub>CCB</sub>	0.9 – 4.5	0.9 – 4.5	–	2.0	μA
ΔI <sub>CCA</sub>	Increase in I <sub>CC</sub> per Input Voltage, Other Inputs at V <sub>CCA</sub> or GND	V <sub>I</sub> = V <sub>CCA</sub> - 0.6 V; V <sub>I</sub> = V <sub>CCA</sub> or GND	4.5	4.5	–	10	μA
			3.6	3.6	–	5.0	
ΔI <sub>CCB</sub>	Increase in I <sub>CC</sub> per Input Voltage, Other Inputs at V <sub>CCA</sub> or GND	V <sub>I</sub> = V <sub>CCA</sub> - 0.6 V; V <sub>I</sub> = V <sub>CCA</sub> or GND	4.5	4.5	–	10	μA
			3.6	3.6	–	5.0	
I <sub>OZ</sub>	I/O Tri-State Output Leakage Current	T <sub>A</sub> = 25°C, OE = 0 V	0.9 – 4.5	0.9 – 4.5	-1.0	1.0	μA

Product parametric performance is indicated in the Electrical Characteristics for the listed test conditions, unless otherwise noted. Product performance may not be indicated by the Electrical Characteristics if operated under different conditions.

# NLSV2T244

## TOTAL STATIC POWER CONSUMPTION ( $I_{CCA} + I_{CCB}$ )

$V_{CCA}$ (V)	-40°C to +85°C										Unit
	$V_{CCB}$ (V)										
	4.5		3.3		2.8		1.8		0.9		
	Min	Max	Min	Max	Min	Max	Min	Max	Min	Max	
4.5		2		2		2		2		< 1.5	$\mu$ A
3.3		2		2		2		2		< 1.5	$\mu$ A
2.8		< 2		< 1		< 1		< 0.5		< 0.5	$\mu$ A
1.8		< 1		< 1		< 0.5		< 0.5		< 0.5	$\mu$ A
0.9		< 0.5		< 0.5		< 0.5		< 0.5		< 0.5	$\mu$ A

NOTE: Connect ground before applying supply voltage  $V_{CCA}$  or  $V_{CCB}$ . This device is designed with the feature that the power-up sequence of  $V_{CCA}$  and  $V_{CCB}$  will not damage the IC.

## AC ELECTRICAL CHARACTERISTICS

Symbol	Parameter	$V_{CCA}$ (V)	-40°C to +85°C										Unit
			$V_{CCB}$ (V)										
			4.5		3.3		2.8		1.8		1.2		
			Min	Max	Min	Max	Min	Max	Min	Max	Min	Max	
$t_{PLH}$ , $t_{PHL}$ (Note 1)	Propagation Delay, $A_n$ to $B_n$	4.5		1.6		1.8		2.0		2.1		2.3	nS
		3.3		1.7		1.9		2.1		2.3		2.6	
		2.8		1.9		2.1		2.3		2.5		2.8	
		1.8		2.1		2.4		2.5		2.7		3.0	
		1.2		2.4		2.7		2.8		3.0		3.3	
$t_{PZH}$ , $t_{PZL}$ (Note 1)	Output Enable, $\overline{OE}$ to $B_n$	4.5		2.6		3.8		4.0		4.1		4.3	nS
		3.3		3.7		3.9		4.1		4.3		4.6	
		2.5		3.9		4.1		4.3		4.5		4.8	
		1.8		4.1		4.4		4.5		4.7		5.0	
		1.2		4.4		4.7		4.8		5.0		5.3	
$t_{PHZ}$ , $t_{PLZ}$ (Note 1)	Output Disable, $\overline{OE}$ to $B_n$	4.5		2.6		3.8		4.0		4.1		4.3	nS
		3.3		3.7		3.9		4.1		4.3		4.6	
		2.5		3.9		4.1		4.3		4.5		4.8	
		1.8		4.1		4.4		4.5		4.7		5.0	
		1.2		4.4		4.7		4.8		5.0		5.3	
$t_{OSHL}$ , $t_{OSLH}$ (Note 1)	Output to Output Skew, Time	4.5		0.15		0.15		0.15		0.15		0.15	nS
		3.3		0.15		0.15		0.15		0.15		0.15	
		2.5		0.15		0.15		0.15		0.15		0.15	
		1.8		0.15		0.15		0.15		0.15		0.15	
		1.2		0.15		0.15		0.15		0.15		0.15	

1. Propagation delays defined per Figure 2.

## CAPACITANCE

Symbol	Parameter	Test Conditions	Typ (Note 2)	Unit
$C_{IN}$	Control Pin Input Capacitance	$V_{CCA} = V_{CCB} = 3.3$ V, $V_I = 0$ V or $V_{CCA/B}$	3.5	pF
$C_{I/O}$	I/O Pin Input Capacitance	$V_{CCA} = V_{CCB} = 3.3$ V, $V_I = 0$ V or $V_{CCA/B}$	5.0	pF
$C_{PD}$	Power Dissipation Capacitance	$V_{CCA} = V_{CCB} = 3.3$ V, $V_I = 0$ V or $V_{CCA}$ , $f = 10$ MHz	20	pF

2. Typical values are at  $T_A = +25^\circ\text{C}$ .

3.  $C_{PD}$  is defined as the value of the IC's equivalent capacitance from which the operating current can be calculated from:  
 $I_{CC(\text{operating})} \cong C_{PD} \times V_{CC} \times f_{IN} \times N_{SW}$  where  $I_{CC} = I_{CCA} + I_{CCB}$  and  $N_{SW}$  = total number of outputs switching.

# NLSV2T244



Figure 2. AC (Propagation Delay) Test Circuit

Test	Switch
$t_{PLH}$ , $t_{PHL}$	OPEN
$t_{PLZ}$ , $t_{PZL}$	$V_{CCO} \times 2$
$t_{PHZ}$ , $t_{PZH}$	GND

$C_L = 15 \text{ pF}$  or equivalent (includes probe and jig capacitance)  
 $R_L = 2 \text{ k}\Omega$  or equivalent  
 $Z_{OUT}$  of pulse generator =  $50 \Omega$

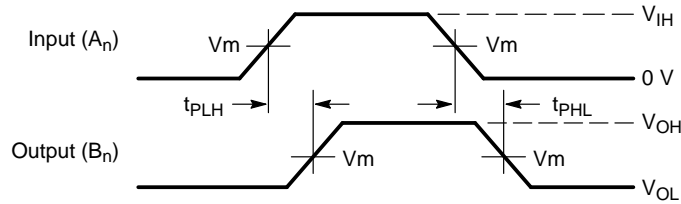

Waveform 1 – Propagation Delays

$t_R = t_F = 2.0 \text{ ns}$ , 10% to 90%;  $f = 1 \text{ MHz}$ ;  $t_W = 500 \text{ ns}$



Waveform 2 – Output Enable and Disable Times

$t_R = t_F = 2.0 \text{ ns}$ , 10% to 90%;  $f = 1 \text{ MHz}$ ;  $t_W = 500 \text{ ns}$

Figure 3. AC (Propagation Delay) Test Circuit Waveforms

Symbol	$V_{CC}$				
	3.0 V – 4.5 V	2.3 V – 2.7 V	1.65 V – 1.95 V	1.4 V – 1.6 V	0.9 V – 1.3 V
$V_{mA}$	$V_{CCA}/2$	$V_{CCA}/2$	$V_{CCA}/2$	$V_{CCA}/2$	$V_{CCA}/2$
$V_{mB}$	$V_{CCB}/2$	$V_{CCB}/2$	$V_{CCB}/2$	$V_{CCB}/2$	$V_{CCB}/2$
$V_X$	$V_{OL} \times 0.1$	$V_{OL} \times 0.1$	$V_{OL} \times 0.1$	$V_{OL} \times 0.1$	$V_{OL} \times 0.1$
$V_Y$	$V_{OH} \times 0.9$	$V_{OH} \times 0.9$	$V_{OH} \times 0.9$	$V_{OH} \times 0.9$	$V_{OH} \times 0.9$

# NLSV2T244

## PACKAGE DIMENSIONS

UDFN8 1.8 x 1.2, 0.4P  
CASE 517AJ  
ISSUE O

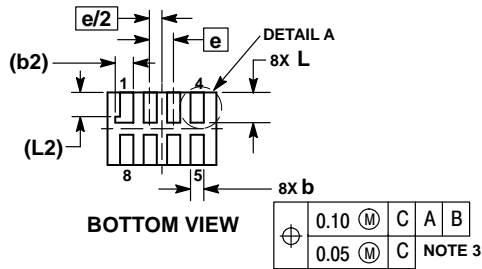
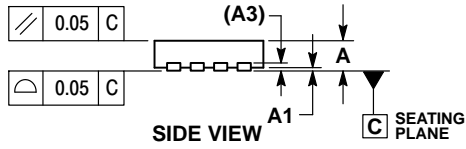
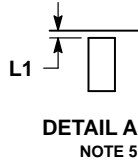
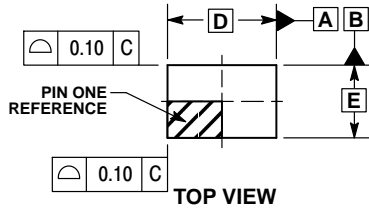

NOTES:

1. DIMENSIONING AND TOLERANCING PER ASME Y14.5M, 1994.
2. CONTROLLING DIMENSION: MILLIMETERS.
3. DIMENSION b APPLIES TO PLATED TERMINAL AND IS MEASURED BETWEEN 0.15 AND 0.30 mm FROM TERMINAL TIP.
4. MOLD FLASH ALLOWED ON TERMINALS ALONG EDGE OF PACKAGE. FLASH MAY NOT EXCEED 0.03 ONTO BOTTOM SURFACE OF TERMINALS.
5. DETAIL A SHOWS OPTIONAL CONSTRUCTION FOR TERMINALS.

DIM	MILLIMETERS	
	MIN	MAX
A	0.45	0.55
A1	0.00	0.05
A3	0.127	REF
b	0.15	0.25
b2	0.30	REF
D	1.80	BSC
E	1.20	BSC
e	0.40	BSC
L	0.45	0.55
L1	0.00	0.03
L2	0.40	REF

### MOUNTING FOOTPRINT SOLDERMASK DEFINED

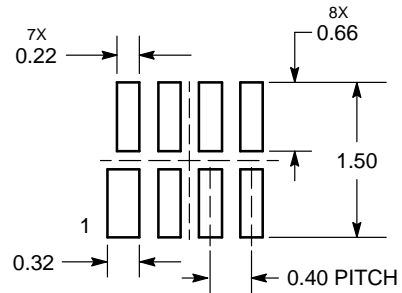

DIMENSIONS: MILLIMETERS

# NLSV2T244

## PACKAGE DIMENSIONS

SO-8  
CASE 751-07  
ISSUE AK

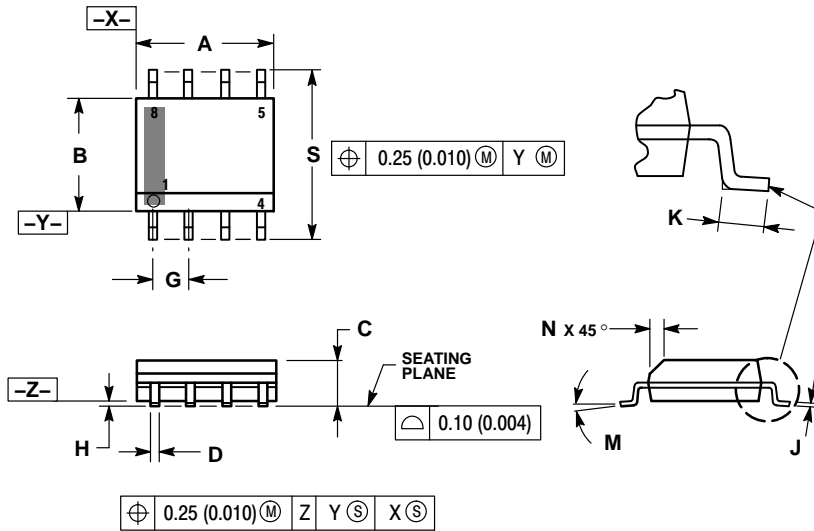

NOTES:

1. DIMENSIONING AND TOLERANCING PER ANSI Y14.5M, 1982.
2. CONTROLLING DIMENSION: MILLIMETER.
3. DIMENSION A AND B DO NOT INCLUDE MOLD PROTRUSION.
4. MAXIMUM MOLD PROTRUSION 0.15 (0.006) PER SIDE.
5. DIMENSION D DOES NOT INCLUDE DAMBAR PROTRUSION. ALLOWABLE DAMBAR PROTRUSION SHALL BE 0.127 (0.005) TOTAL IN EXCESS OF THE D DIMENSION AT MAXIMUM MATERIAL CONDITION.
6. 751-01 THRU 751-06 ARE OBSOLETE. NEW STANDARD IS 751-07.

DIM	MILLIMETERS		INCHES	
	MIN	MAX	MIN	MAX
A	4.80	5.00	0.189	0.197
B	3.80	4.00	0.150	0.157
C	1.35	1.75	0.053	0.069
D	0.33	0.51	0.013	0.020
G	1.27 BSC		0.050 BSC	
H	0.10	0.25	0.004	0.010
J	0.19	0.25	0.007	0.010
K	0.40	1.27	0.016	0.050
M	0°	8°	0°	8°
N	0.25	0.50	0.010	0.020
S	5.80	6.20	0.228	0.244

### SOLDERING FOOTPRINT\*

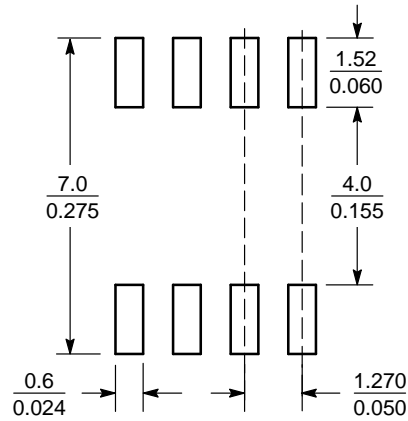

SCALE 6:1  $\left(\frac{\text{mm}}{\text{inches}}\right)$

\*For additional information on our Pb-Free strategy and soldering details, please download the ON Semiconductor Soldering and Mounting Techniques Reference Manual, SOLDERRM/D.



# NLSV2T244

## PACKAGE DIMENSIONS

**Micro8™**  
CASE 846A-02  
ISSUE J

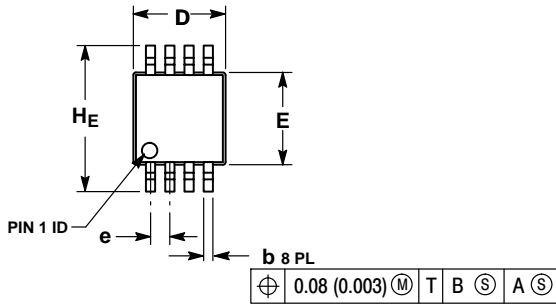

**NOTES:**

1. DIMENSIONING AND TOLERANCING PER ANSI Y14.5M, 1982.
2. CONTROLLING DIMENSION: MILLIMETER.
3. DIMENSION A DOES NOT INCLUDE MOLD FLASH, PROTRUSIONS OR GATE BURRS. MOLD FLASH, PROTRUSIONS OR GATE BURRS SHALL NOT EXCEED 0.15 (0.006) PER SIDE.
4. DIMENSION B DOES NOT INCLUDE INTERLEAD FLASH OR PROTRUSION. INTERLEAD FLASH OR PROTRUSION SHALL NOT EXCEED 0.25 (0.010) PER SIDE.
5. 846A-01 OBSOLETE, NEW STANDARD 846A-02.

DIM	MILLIMETERS			INCHES		
	MIN	NOM	MAX	MIN	NOM	MAX
A	---	---	1.10	---	---	0.043
A1	0.05	0.08	0.15	0.002	0.003	0.006
b	0.25	0.33	0.40	0.010	0.013	0.016
c	0.13	0.18	0.23	0.005	0.007	0.009
D	2.90	3.00	3.10	0.114	0.118	0.122
E	2.90	3.00	3.10	0.114	0.118	0.122
e	0.65 BSC			0.026 BSC		
L	0.40	0.55	0.70	0.016	0.021	0.028
HE	4.75	4.90	5.05	0.187	0.193	0.199

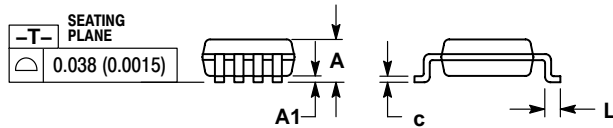

### RECOMMENDED SOLDERING FOOTPRINT\*

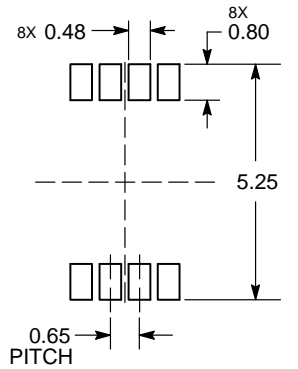

\*For additional information on our Pb-Free strategy and soldering details, please download the ON Semiconductor Soldering and Mounting Techniques Reference Manual, SOLDERRM/D.

ON Semiconductor and the  are registered trademarks of Semiconductor Components Industries, LLC (SCILLC) or its subsidiaries in the United States and/or other countries. SCILLC owns the rights to a number of patents, trademarks, copyrights, trade secrets, and other intellectual property. A listing of SCILLC's product/patent coverage may be accessed at [www.onsemi.com/site/pdf/Patent-Marking.pdf](http://www.onsemi.com/site/pdf/Patent-Marking.pdf). SCILLC reserves the right to make changes without further notice to any products herein. SCILLC makes no warranty, representation or guarantee regarding the suitability of its products for any particular purpose, nor does SCILLC assume any liability arising out of the application or use of any product or circuit, and specifically disclaims any and all liability, including without limitation special, consequential or incidental damages. "Typical" parameters which may be provided in SCILLC data sheets and/or specifications can and do vary in different applications and actual performance may vary over time. All operating parameters, including "Typicals" must be validated for each customer application by customer's technical experts. SCILLC does not convey any license under its patent rights nor the rights of others. SCILLC products are not designed, intended, or authorized for use as components in systems intended for surgical implant into the body, or other applications intended to support or sustain life, or for any other application in which the failure of the SCILLC product could create a situation where personal injury or death may occur. Should Buyer purchase or use SCILLC products for any such unintended or unauthorized application, Buyer shall indemnify and hold SCILLC and its officers, employees, subsidiaries, affiliates, and distributors harmless against all claims, costs, damages, and expenses, and reasonable attorney fees arising out of, directly or indirectly, any claim of personal injury or death associated with such unintended or unauthorized use, even if such claim alleges that SCILLC was negligent regarding the design or manufacture of the part. SCILLC is an Equal Opportunity/Affirmative Action Employer. This literature is subject to all applicable copyright laws and is not for resale in any manner.

### PUBLICATION ORDERING INFORMATION

**LITERATURE FULFILLMENT:**  
Literature Distribution Center for ON Semiconductor  
19521 E. 32nd Pkwy, Aurora, Colorado 80011 USA  
**Phone:** 303-675-2175 or 800-344-3860 Toll Free USA/Canada  
**Fax:** 303-675-2176 or 800-344-3867 Toll Free USA/Canada  
**Email:** [orderlit@onsemi.com](mailto:orderlit@onsemi.com)

**N. American Technical Support:** 800-282-9855 Toll Free  
USA/Canada  
**Europe, Middle East and Africa Technical Support:**  
Phone: 421 33 790 2910  
**Japan Customer Focus Center**  
Phone: 81-3-5817-1050

**ON Semiconductor Website:** [www.onsemi.com](http://www.onsemi.com)  
**Order Literature:** <http://www.onsemi.com/orderlit>  
For additional information, please contact your local Sales Representative

# Mouser Electronics

Authorized Distributor

Click to View Pricing, Inventory, Delivery & Lifecycle Information:

[ON Semiconductor:](#)

[NLSV2T244DMR2G](#) [NLSV2T244DR2G](#) [NLSV2T244MUTAG](#)