



Single/Dual LVDS Line Receivers with Ultra-Low Pulse Skew in SOT23

MAX9111/MAX9113

General Description

The MAX9111/MAX9113 single/dual low-voltage differential signaling (LVDS) receivers are designed for high-speed applications requiring minimum power consumption, space, and noise. Both devices support switching rates exceeding 500Mbps while operating from a single +3.3V supply, and feature ultra-low 300ps (max) pulse skew required for high-resolution imaging applications such as laser printers and digital copiers.

The MAX9111 is a single LVDS receiver, and the MAX9113 is a dual LVDS receiver.

Both devices conform to the EIA/TIA-644 LVDS standard and convert LVDS to LVTTTL/CMOS-compatible outputs. A fail-safe feature sets the outputs high when the inputs are undriven and open, terminated, or shorted. The MAX9111/MAX9113 are available in space-saving 8-pin SOT23 and SO packages. Refer to the MAX9110/MAX9112 data sheet for single/dual LVDS line drivers.

Applications

| | |
|------------------------------|--------------------------|
| Laser Printers | Network Switches/Routers |
| Digital Copiers | LCD Displays |
| Cellular Phone Base Stations | Backplane Interconnect |
| Telecom Switching Equipment | Clock Distribution |

Features

- ◆ Low 300ps (max) Pulse Skew for High-Resolution Imaging and High-Speed Interconnect
- ◆ Space-Saving 8-Pin SOT23 and SO Packages
- ◆ Pin-Compatible Upgrades to DS90LV018A and DS90LV028A (SO Packages Only)
- ◆ Guaranteed 500Mbps Data Rate
- ◆ Low 29mW Power Dissipation at 3.3V
- ◆ Conform to EIA/TIA-644 Standard
- ◆ Single +3.3V Supply
- ◆ Flow-Through Pinout Simplifies PCB Layout
- ◆ Fail-Safe Circuit Sets Output High for Undriven Inputs
- ◆ High-Impedance LVDS Inputs when Powered Off

Ordering Information

| PART | TEMP RANGE | PIN-PACKAGE | TOP MARK |
|---------------|-----------------|-------------|----------|
| MAX9111EKA | -40°C to +85°C | 8 SOT23 | AAEE |
| MAX9111ESA | -40°C to +85°C | 8 SO | — |
| MAX9113EKA | -40°C to +85°C | 8 SOT23 | AAED |
| MAX9113ESA | -40°C to +85°C | 8 SO | — |
| MAX9113ASA/V+ | -40°C to +125°C | 8 SO | — |

V denotes an automotive qualified part.

+ Denotes a lead(Pb)-free/RoHS-compliant package.

Typical Operating Circuit appears at end of data sheet.

Pin Configurations/Functional Diagrams/Truth Table

MAX9111
SO

MAX9111
SOT23

MAX9113
SO

MAX9113
SOT23

| (IN ₊) - (IN ₋) | OUT ₋ |
|---|------------------|
| ≥ 100mV | H |
| ≤ -100mV | L |
| OPEN | H |
| SHORT | H |
| 100Ω PARALLEL TERMINATION (UNDRIVEN) | H |

H = LOGIC LEVEL HIGH
L = LOGIC LEVEL LOW

Single/Dual LVDS Line Receivers with Ultra-Low Pulse Skew in SOT23

ABSOLUTE MAXIMUM RATINGS

| | | | |
|--|-----------------------------------|--|-----------------|
| V _{CC} to GND | -0.3V to +4V | 8-Pin SO (derate 5.88mW/°C above +70°C)..... | 471mW |
| IN ₋ to GND | -0.3V to +3.9V | Operating Temperature Ranges | |
| OUT ₋ to GND..... | -0.3V to (V _{CC} + 0.3V) | MAX9111_E | -40°C to +85°C |
| ESD Protection All Pins | | MAX9111_A | -40°C to +125°C |
| (Human Body Model, IN ₊ , IN ₋) | ±11kV | Storage Temperature Range | -65°C to +150°C |
| Continuous Power Dissipation (T _A = +70°C) | | Lead Temperature (soldering, 10s) | +300°C |
| 8-Pin SOT23 (derate 8.9mW/°C above +70°C)..... | 714mW | | |

Stresses beyond those listed under "Absolute Maximum Ratings" may cause permanent damage to the device. These are stress ratings only, and functional operation of the device at these or any other conditions beyond those indicated in the operational sections of the specifications is not implied. Exposure to absolute maximum rating conditions for extended periods may affect device reliability.

ELECTRICAL CHARACTERISTICS

(V_{CC} = +3.0V to +3.6V, magnitude of input voltage, |V_{ID}| = +0.1V to +1.0V, V_{CM} = |V_{ID}|/2 to (2.4V - (|V_{ID}|/2)), T_A = T_{MIN} to T_{MAX}. Typical values are at V_{CC} = +3.3V and T_A = +25°C, unless otherwise noted.) (Notes 1, 2)

| PARAMETER | SYMBOL | CONDITIONS | MIN | TYP | MAX | UNITS |
|--|-------------------|--|-------------------------------------|-----|------|-------|
| Differential Input High Threshold (Note 3) | V _{TH} | V _{CM} = 0.05V, 1.2V, 2.75V at 3.3V | | | 100 | mV |
| Differential Input Low Threshold (Note 3) | V _{TL} | V _{CM} = 0.05V, 1.2V, 2.75V at 3.3V | -100 | | | mV |
| Differential Input Resistance | R _{DIFF} | V _{CM} = 0.2V or 2.2V, V _{ID} = ±0.4V, V _{CC} = 0 or 3.6V | 5 | 18 | | kΩ |
| Output High Voltage (OUT ₋) | V _{OH} | I _{OH} = -4mA | V _{ID} = +200mV | 2.7 | | V |
| | | | Inputs shorted, undriven | 2.7 | | |
| | | | 100Ω parallel termination, undriven | 2.7 | | |
| Output Low Voltage (OUT ₋) | V _{OL} | I _{OL} = 4mA, V _{ID} = -200mV | | | 0.4 | |
| Output Short-Circuit Current | I _{OS} | V _{ID} = +200mV, V _{OUT₋} = 0 | | | -100 | mA |
| No-Load Supply Current | I _{CC} | MAX9111 | | 4.2 | 6 | mA |
| | | MAX9113 | | 8.7 | 11 | |

Single/Dual LVDS Line Receivers with Ultra-Low Pulse Skew in SOT23

MAX9111/MAX9113

SWITCHING CHARACTERISTICS

($V_{CC} = +3.0V$ to $+3.6V$, $T_A = T_{MIN}$ to T_{MAX} . Typical values are at $V_{CC} = +3.3V$ and $T_A = +25^\circ C$, unless otherwise noted.) (Notes 4, 5, 6)

| PARAMETER | SYMBOL | CONDITIONS | MIN | TYP | MAX | UNITS | |
|---|------------|--|----------------------|-----|------|-------|----|
| Differential Propagation Delay High to Low | t_{PHLD} | $C_L = 15pF$, $V_{ID} = \pm 200mV$, $V_{CM} = 1.2V$ (Figures 1, 2) | $T_A = +85^\circ C$ | 1.0 | 1.77 | 2.5 | ns |
| | | | $T_A = +125^\circ C$ | | | 3.0 | |
| Differential Propagation Delay Low to High | t_{PLHD} | $C_L = 15pF$, $V_{ID} = \pm 200mV$, $V_{CM} = 1.2V$ (Figures 1, 2) | $T_A = +85^\circ C$ | 1.0 | 1.68 | 2.5 | ns |
| | | | $T_A = +125^\circ C$ | | | 3.0 | |
| Differential Pulse Skew $ t_{PLHD} - t_{PHLD} $ (Note 7) | t_{SKD1} | $C_L = 15pF$, $V_{ID} = \pm 200mV$, $V_{CM} = 1.2V$ (Figures 1, 2) | | 90 | 300 | ps | |
| Differential Channel-to-Channel Skew; Same Device (MAX9113 only) (Note 8) | t_{SKD2} | | | 140 | 400 | ps | |
| Differential Part-to-Part Skew (Note 9) | t_{SKD3} | | | | 1 | ns | |
| Differential Part-to-Part Skew (MAX9113 only) (Note 10) | t_{SKD4} | | | | 1.5 | ns | |
| Rise Time | t_{TLH} | $C_L = 15pF$, $V_{ID} = \pm 200mV$, $V_{CM} = 1.2V$ (Figures 1, 2) | $T_A = +85^\circ C$ | | 0.6 | 0.8 | ns |
| | | | $T_A = +125^\circ C$ | | | 1.0 | |
| Fall Time | t_{THL} | $C_L = 15pF$, $V_{ID} = \pm 200mV$, $V_{CM} = 1.2V$ (Figures 1, 2) | $T_A = +85^\circ C$ | | 0.6 | 0.8 | ns |
| | | | $T_A = +125^\circ C$ | | | 1.0 | |
| Maximum Operating Frequency | f_{MAX} | All channels switching, $C_L = 15pF$, $V_{OL}(\max) = 0.4V$, $V_{OH}(\min) = 2.7V$, 40% < duty cycle < 60% (Note 6) | 250 | 300 | | MHz | |

- Note 1:** Maximum and minimum limits over temperature are guaranteed by design and characterization. Devices are production tested at $T_A = +25^\circ C$.
- Note 2:** Current into the device is defined as positive. Current out of the devices is defined as negative. All voltages are referenced to ground except V_{TH} and V_{TL} .
- Note 3:** Guaranteed by design, not production tested.
- Note 4:** AC parameters are guaranteed by design and characterization.
- Note 5:** C_L includes probe and test jig capacitance.
- Note 6:** f_{MAX} generator output conditions: $t_R = t_F < 1ns$ (0 to 100%), 50% duty cycle, $V_{OH} = 1.3V$, $V_{OL} = 1.1V$.
- Note 7:** t_{SKD1} is the magnitude difference of differential propagation delays in a channel. $t_{SKD1} = |t_{PLHD} - t_{PHLD}|$.
- Note 8:** t_{SKD2} is the magnitude difference of the t_{PLHD} or t_{PHLD} of one channel and the t_{PLHD} or t_{PHLD} of the other channel on the same device.
- Note 9:** t_{SKD3} is the magnitude difference of any differential propagation delays between devices at the same V_{CC} and within $5^\circ C$ of each other.
- Note 10:** t_{SKD4} is the magnitude difference of any differential propagation delays between devices operating over the rated supply and temperature ranges.

Single/Dual LVDS Line Receivers with Ultra-Low Pulse Skew in SOT23

Test Circuit Diagrams

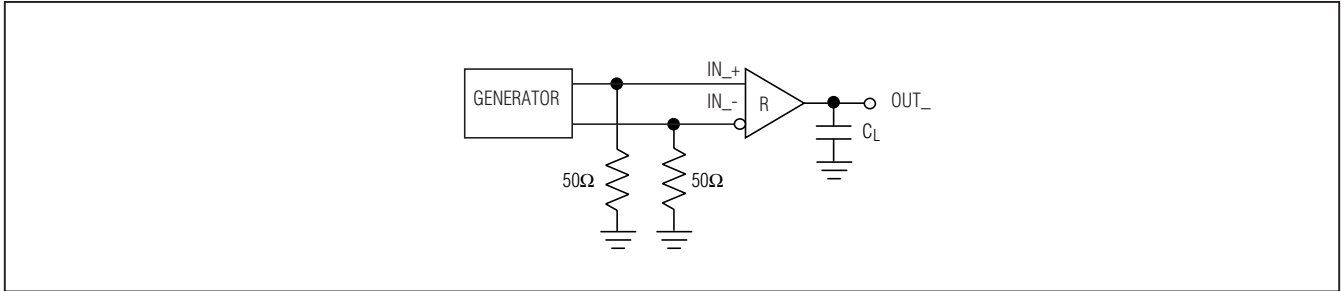

Figure 1. Receiver Propagation Delay and Transition Time Test Circuit

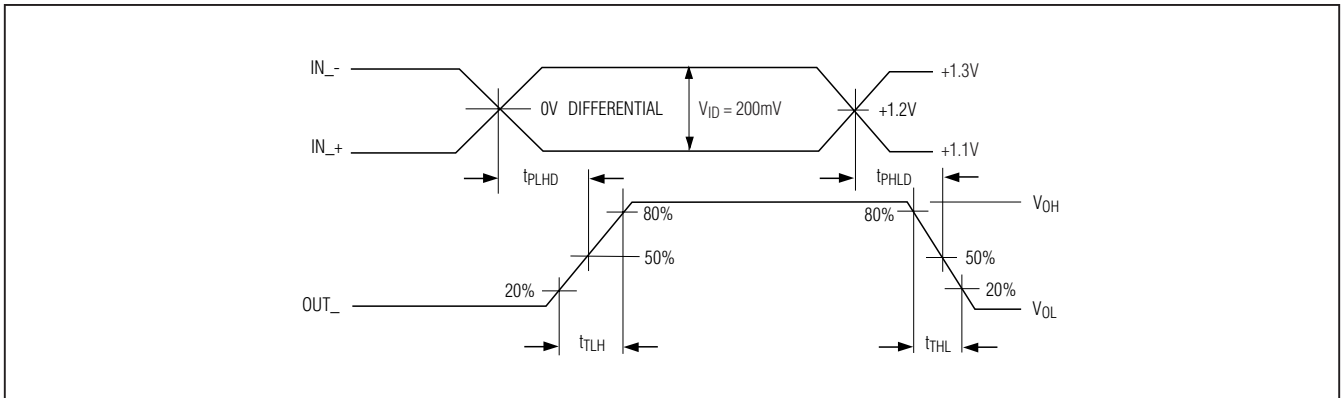

Figure 2. Receiver Propagation Delay and Transition Time Waveforms

Single/Dual LVDS Line Receivers with Ultra-Low Pulse Skew in SOT23

Typical Operating Characteristics

($V_{CC} = 3.3V$, $|V_{ID}| = 200mV$, $V_{CM} = 1.2V$, $f_{IN} = 200MHz$, $C_L = 15pF$, $T_A = +25^\circ C$ and over recommended operating conditions, unless otherwise specified.)

MAX9111/MAX9113

OUTPUT HIGH VOLTAGE vs. SUPPLY VOLTAGE

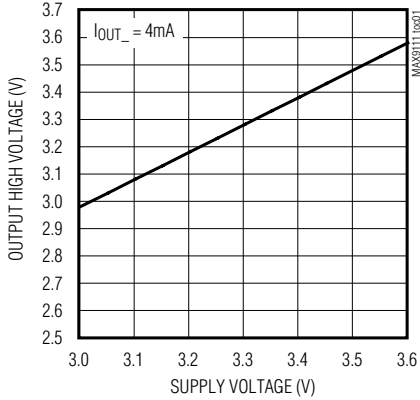

OUTPUT LOW VOLTAGE vs. SUPPLY VOLTAGE

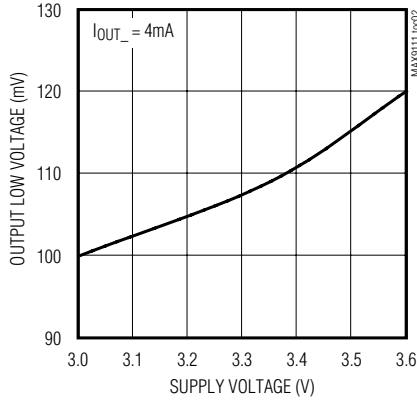

OUTPUT SHORT-CIRCUIT CURRENT vs. SUPPLY VOLTAGE

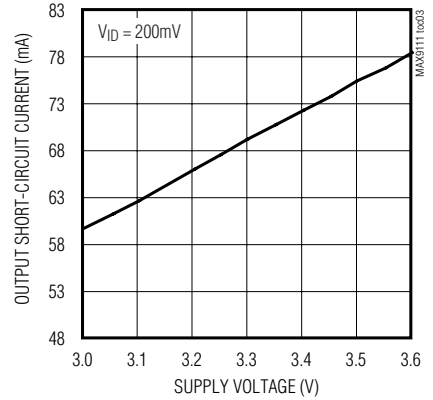

DIFFERENTIAL THRESHOLD VOLTAGE vs. SUPPLY VOLTAGE

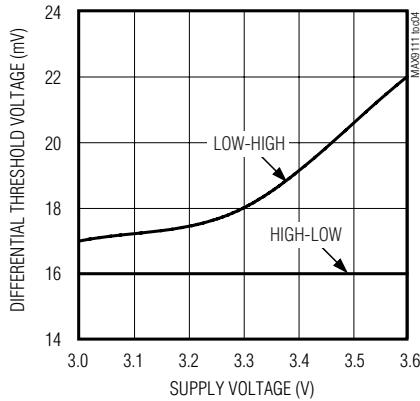

MAX9113 POWER-SUPPLY CURRENT vs. FREQUENCY

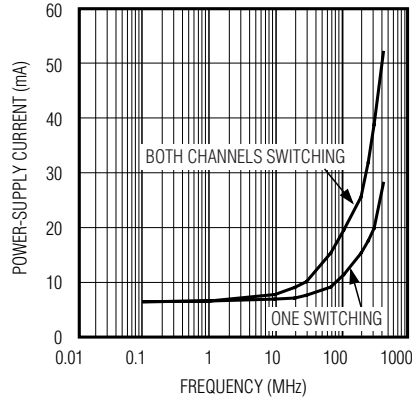

POWER-SUPPLY CURRENT vs. TEMPERATURE

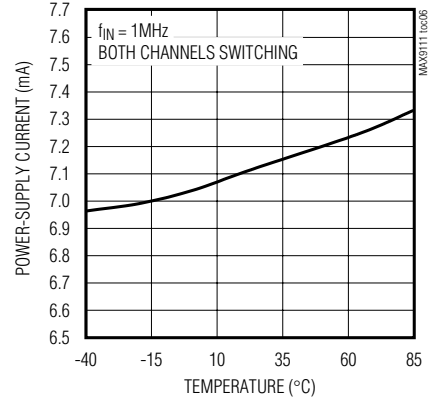

DIFFERENTIAL PROPAGATION DELAY vs. SUPPLY VOLTAGE

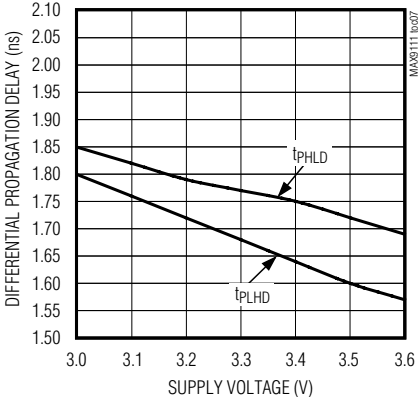

DIFFERENTIAL PROPAGATION DELAY vs. TEMPERATURE

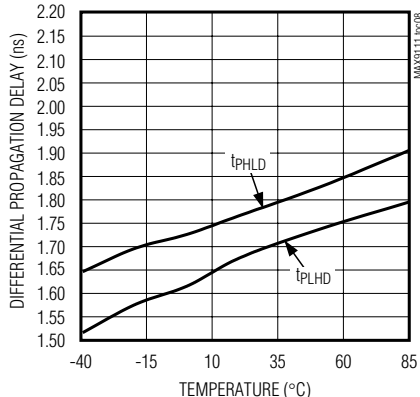

DIFFERENTIAL PULSE SKEW vs. SUPPLY VOLTAGE

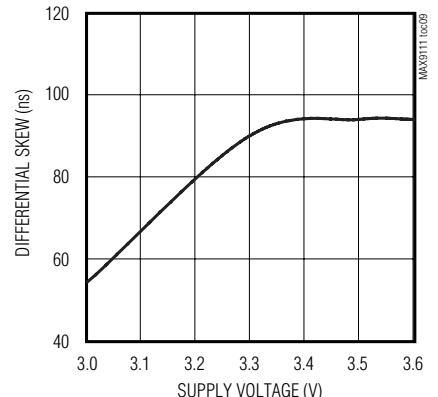

Single/Dual LVDS Line Receivers with Ultra-Low Pulse Skew in SOT23

Typical Operating Characteristics (continued)

($V_{CC} = 3.3V$, $|V_{ID}| = 200mV$, $V_{CM} = 1.2V$, $f_{IN} = 200MHz$, $C_L = 15pF$, $T_A = +25^\circ C$ and over recommended operating conditions, unless otherwise specified.)

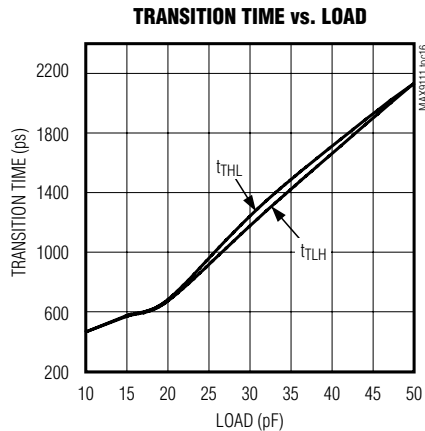
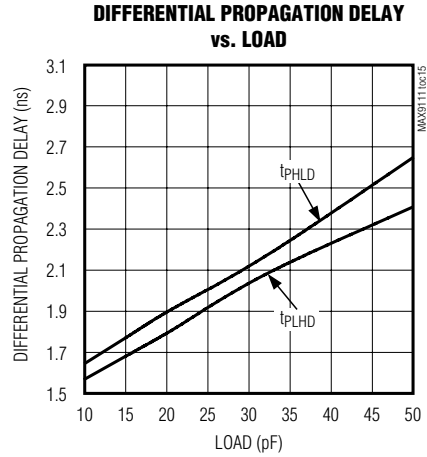
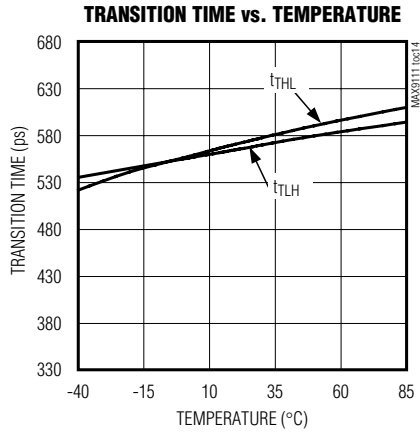
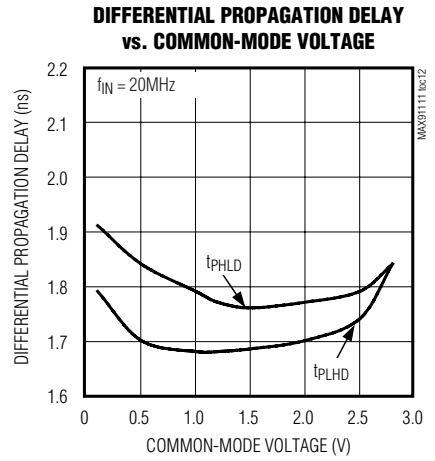
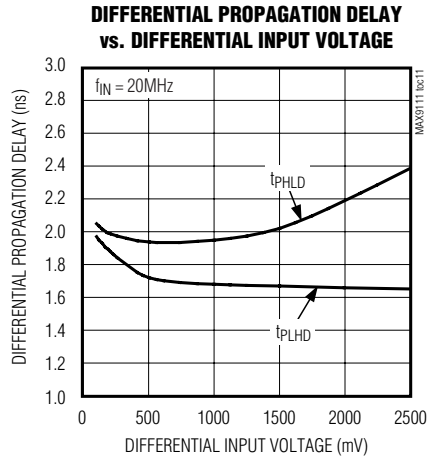
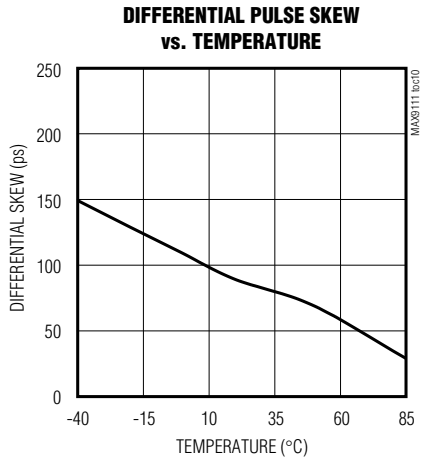

Single/Dual LVDS Line Receivers with Ultra-Low Pulse Skew in SOT23

Pin Description

| PIN | | | | NAME | FUNCTION |
|---------|---------|---------|------|-----------------|--|
| MAX9111 | | MAX9113 | | | |
| SOT23-8 | SO-8 | SOT23-8 | SO-8 | | |
| 1 | 8 | 1 | 8 | V _{CC} | Power Supply |
| 2 | 5 | 2 | 5 | GND | Ground |
| 8 | 1 | 8 | 1 | IN-/IN1- | Receiver Inverting Differential Input |
| 7 | 2 | 7 | 2 | IN+/IN1+ | Receiver Noninverting Differential Input |
| — | — | 5 | 4 | IN2- | Receiver Inverting Differential Input |
| — | — | 6 | 3 | IN2+ | Receiver Noninverting Differential Input |
| 3 | 7 | 3 | 7 | OUT/OUT1 | Receiver Output |
| — | — | 4 | 6 | OUT2 | Receiver Output |
| 4, 5, 6 | 3, 4, 6 | — | — | N.C. | No Connection. Not internally connected. |

MAX9111/MAX9113

Detailed Description

LVDS Inputs

The MAX9111/MAX9113 feature LVDS inputs for interfacing high-speed digital circuitry. The LVDS interface standard is a signaling method intended for point-to-point communication over a controlled impedance media, as defined by the ANSI/EIA/TIA-644 standards. The technology uses low-voltage signals to achieve fast transition times, minimize power dissipation, and noise immunity. Receivers such as the MAX9111/MAX9113 convert LVDS signals to CMOS/LVTTL signals at rates in excess of 500Mbps. The devices are capable of detecting differential signals as low as 100mV and as high as 1V within a 0V to 2.4V input voltage range. The LVDS standard specifies an input voltage range of 0 to 2.4V referenced to ground.

Fail-Safe

The fail-safe feature sets the output to a high state when the inputs are undriven and open, terminated, or shorted. When using one channel in the MAX9113, leave the unused channel open. The fail-safe feature is not guaranteed to be operational above +85°C.

ESD Protection

As with all Maxim devices, ESD-protection structures are incorporated on all pins to protect against electrostatic discharges encountered during handling and assembly. The receiver inputs of the MAX9111/MAX9113 have extra protection against static electricity. Maxim's engineers have developed state-of-the-art structures to protect these pins against ESD of $\pm 11\text{kV}$ without damage. The ESD structures withstand high ESD in all states: normal operation, shutdown, and powered down.

ESD protection can be tested in various ways; the receiver inputs of this product family are characterized for protection to the limit of $\pm 11\text{kV}$ using the Human Body Model.

Human Body Model

Figure 3a shows the Human Body Model, and Figure 3b shows the current waveform it generates when discharged into a low impedance. This model consists of a 100pF capacitor charged to the ESD voltage of interest, which is then discharged into the test device through a 1.5k Ω resistor.

Single/Dual LVDS Line Receivers with Ultra-Low Pulse Skew in SOT23

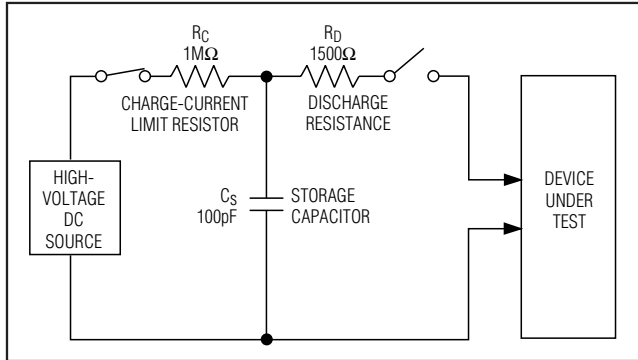

Figure 3a. Human Body ESD Test Modules

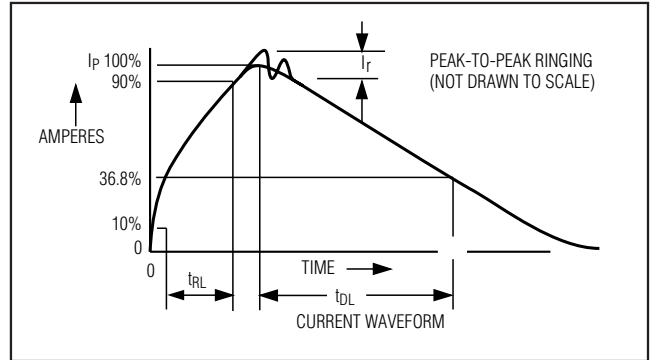

Figure 3b. Human Body Current Waveform

Applications Information

Supply Bypassing

Bypass V_{CC} with high-frequency surface-mount ceramic 0.1 μ F and 0.001 μ F capacitors in parallel, as close to the device as possible, with the 0.001 μ F valued capacitor the closest to the device. For additional supply bypassing, place a 10 μ F tantalum or ceramic capacitor at the point where power enters the circuit board.

Differential Traces

Output trace characteristics affect the performance of the MAX9111/MAX9113. Use controlled impedance traces to match trace impedance to both transmission medium impedance and the termination resistor. Eliminate reflections and ensure that noise couples as common mode by running the differential traces close together. Reduce skew by matching the electrical length of the traces. Excessive skew can result in a degradation of magnetic field cancellation.

Maintain the distance between the differential traces to avoid discontinuities in differential impedance. Avoid 90° turns and minimize the number of vias to further prevent impedance discontinuities.

Cables and Connectors

Transmission media should have a differential characteristic impedance of about 100 Ω . Use cables and connectors that have matched impedance to minimize impedance discontinuities.

Avoid the use of unbalanced cables such as ribbon or simple coaxial cable. Balanced cables such as twisted pair offer superior signal quality and tend to generate less EMI due to canceling effects. Balanced cables tend to pick up noise as common mode, which is rejected by the LVDS receiver.

Termination

The MAX9111/MAX9113 input differential voltage depends on the driver current and termination resistance. Refer to the MAX9110/MAX9112 differential driver data sheet for this information.

Minimize the distance between the termination resistor and receiver inputs. Use a single 1% to 2% surface-mount resistor across the receiver inputs.

Board Layout

For LVDS applications, a four-layer PCB that provides separate power, ground, LVDS signals, and input signals is recommended. Isolate the input and LVDS signals from each other to prevent coupling. For best results, separate the input and LVDS signal planes with the power and ground planes.

Single/Dual LVDS Line Receivers with Ultra-Low Pulse Skew in SOT23

Typical Operating Circuit

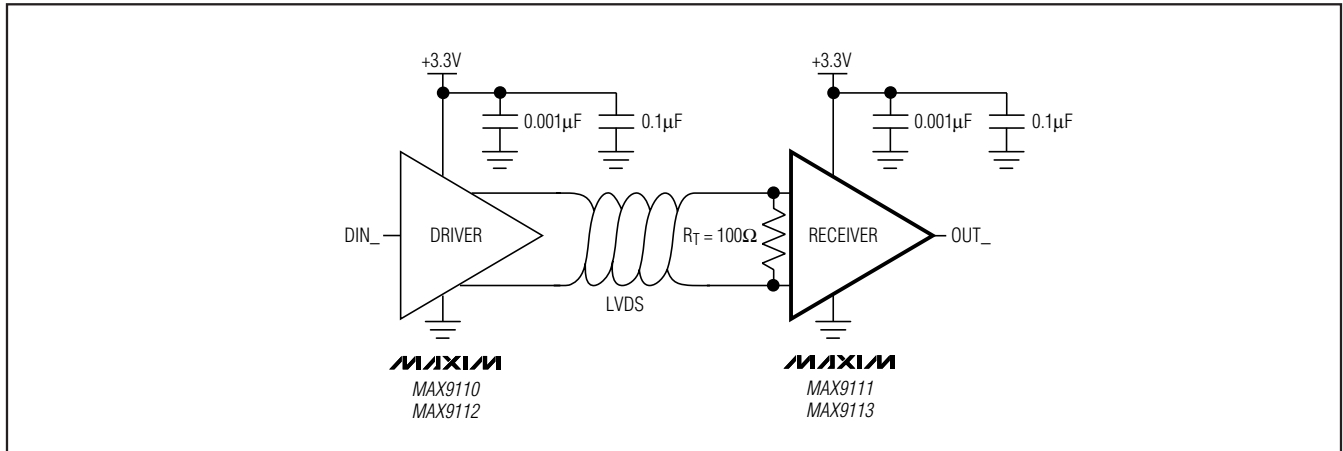

MAX9111/MAX9113

Chip Information

PROCESS: CMOS

Package Information

For the latest package outline information and land patterns, go to www.maxim-ic.com/packages.

| PACKAGE TYPE | PACKAGE CODE | DOCUMENT NO. |
|--------------|--------------|-------------------------|
| 8 SOT23 | K8-1 | 21-0078 |
| 8 SO | S8-2 | 21-0041 |

Single/Dual LVDS Line Receivers with Ultra-Low Pulse Skew in SOT23

Revision History

| REVISION NUMBER | REVISION DATE | DESCRIPTION | PAGES CHANGED |
|-----------------|---------------|---|-----------------|
| 0 | — | Initial release | — |
| 1 | 2/07 | — | 1, 2, 8, 10, 11 |
| 2 | 12/07 | Updated <i>Ordering Information</i> , temperature, <i>Switching Characteristics</i> , <i>Fail-Safe</i> section. | 1, 2, 3, 7 |
| 3 | 3/09 | Added <i>N</i> designation to <i>Ordering Information</i> and updated <i>Termination</i> section. | 1, 8 |

Maxim cannot assume responsibility for use of any circuitry other than circuitry entirely embodied in a Maxim product. No circuit patent licenses are implied. Maxim reserves the right to change the circuitry and specifications without notice at any time.

10 **Maxim Integrated Products, 120 San Gabriel Drive, Sunnyvale, CA 94086 408-737-7600**

Mouser Electronics

Authorized Distributor

Click to View Pricing, Inventory, Delivery & Lifecycle Information:

Maxim Integrated:

[MAX9111EKA+T](#) [MAX9113ESA+](#) [MAX9113ESA+T](#) [MAX9111ESA+](#) [MAX9111ESA+T](#) [MAX9113EKA+T](#)
[MAX6366PKA31+](#) [MAX9113EKA+](#)