

THIS DRAWING IS UNPUBLISHED. RELEASED FOR PUBLICATION
 © COPYRIGHT - By - ALL RIGHTS RESERVED.

REVISIONS					
P	LTR	DESCRIPTION	DATE	DWN	APVD
G		ECR-16-006855	18MAY2016	WL	SY

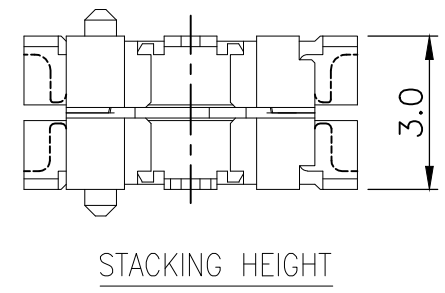
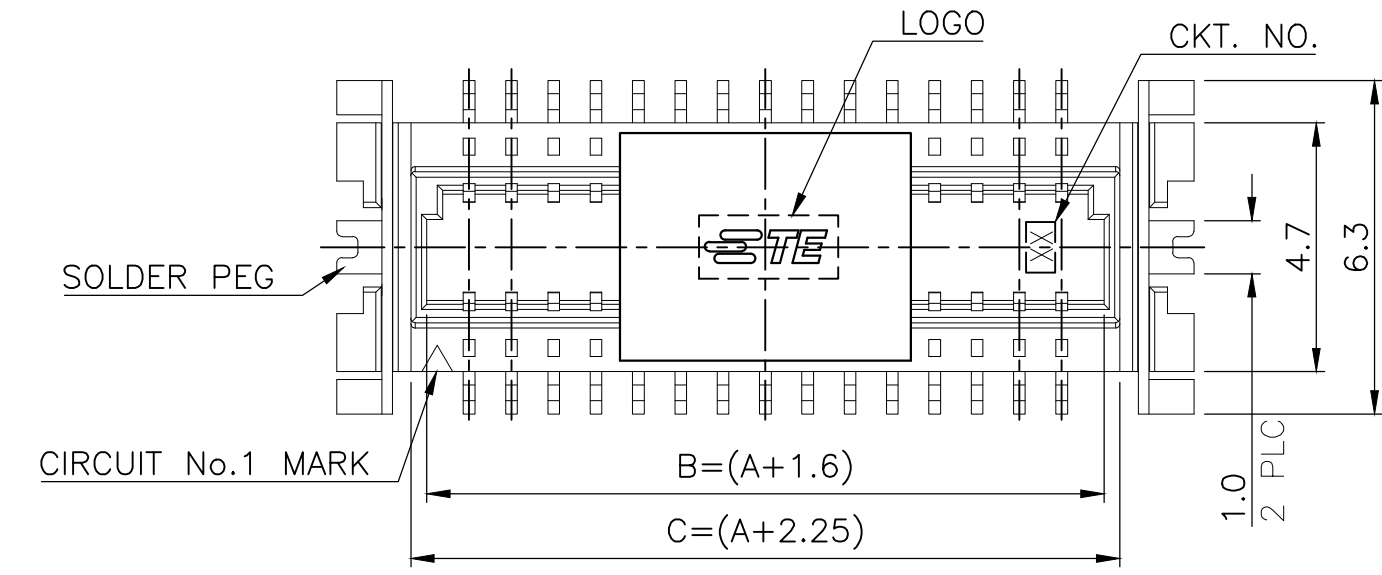

- NOTES:
- MATERIAL:
 - HOUSING: PA6T, UL94V-0; COLOR: NATURAL.
 - CONTACTS: PHOSPHOR BRONZE.
 - PEGS: BRASS.
 - FINISH:

CONTACTS: (SEE TABLE)
 PLATING B : GOLD FLASH ON ENTIRE CONTACT.
 PLATING C : 100μ" MIN. MATTE-TIN ON ENTIRE CONTACT.
 (WITH ENTIRE CONTACT UNDERPLATED 50μ" MIN. NICKEL.)
 PEGS: 100μ" MIN. TIN OR MATTE-TIN OVER 50μ" MIN. NICKEL.
 - PART NUMBER OF MATING RECEPTACLE: X-1775013-X
 - REFLOW SOLDER CAPABLE TO 260°C AS PER TEC-109-201, CONDITION B.
 - SUBSTANCE RESTRICTIONS FOR LOW HALOGEN (BY WEIGHT):

BROMINE (Br) ≤ 900 PPM (0.09%)
 CHLORINE (Cl) ≤ 900 PPM (0.09%)
 TOTAL CONCENTRATION OF (Cl) + (Br) ≤ 1500 PPM (0.15%)

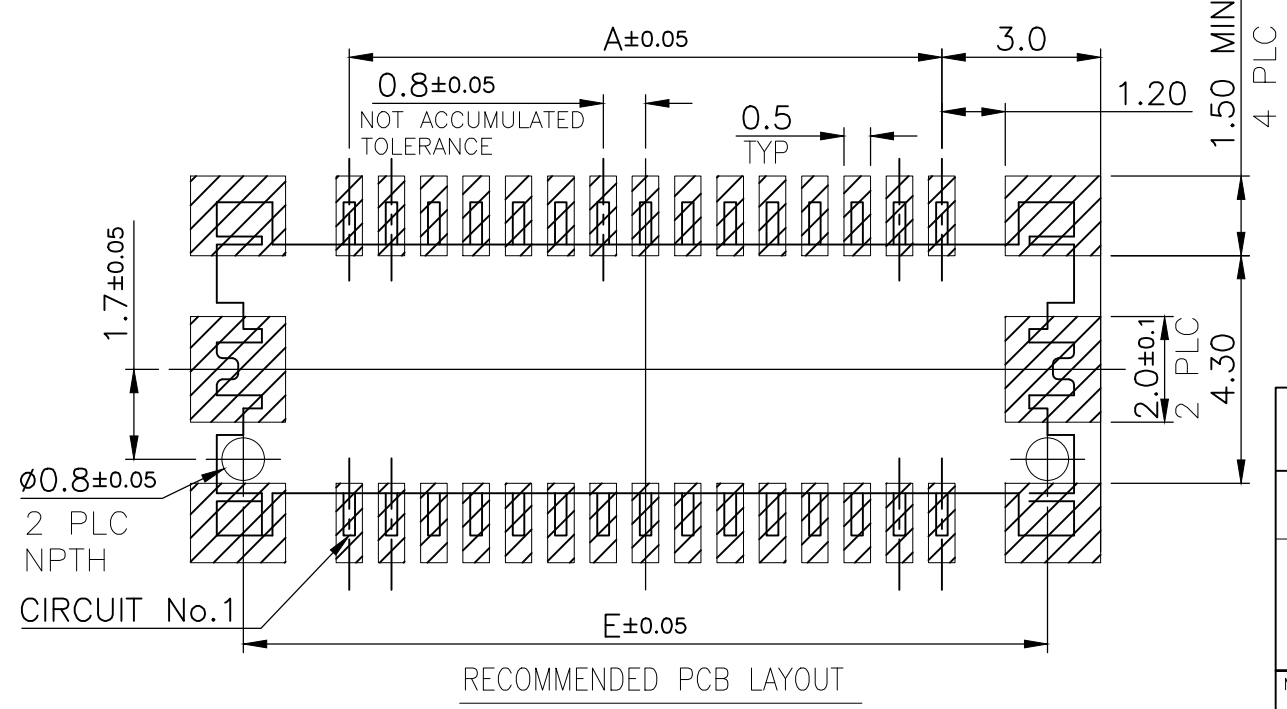
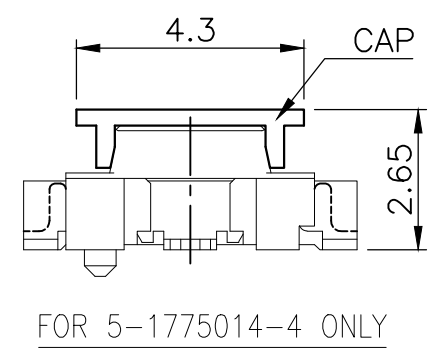
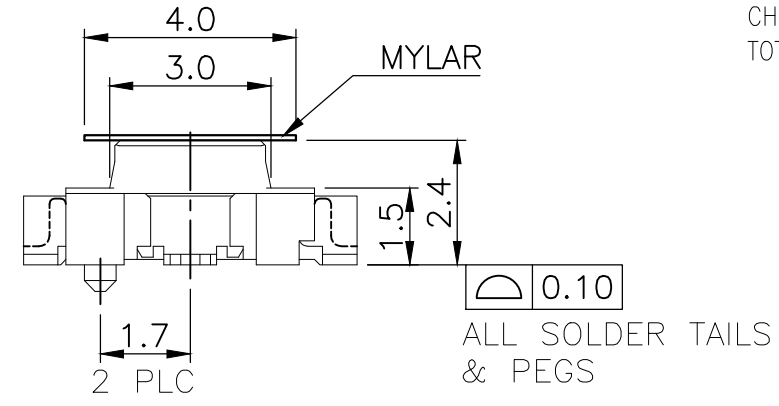
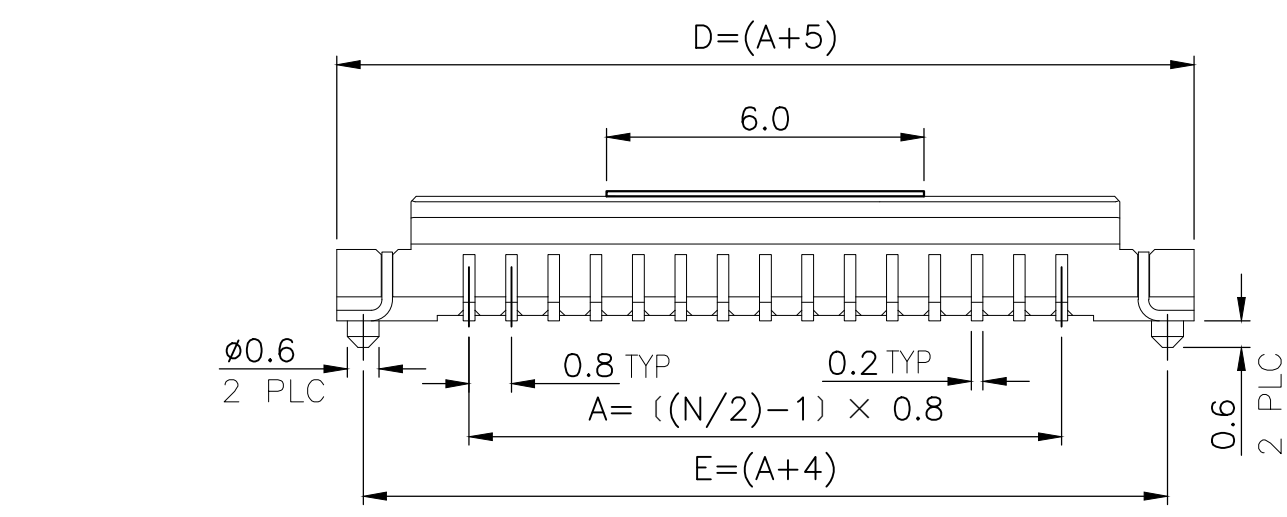

CAP OR MYLAR	CONTACT PLATING	DIMENSIONS					NO. OF CONTACTS	PART NUMBER
		E	D	C	B	A		
CAP	C	8	9	6.25	5.6	4.0	12	5-1775014- 4
MYLAR	B	12.8	13.8	11.05	10.4	8.8	24	1775014- 2
		8	9	6.25	5.6	4.0	12	1775014- 1

THIS DRAWING IS A CONTROLLED DOCUMENT.

DWN	A. WU	05FEB2013	TE Connectivity BOARD-TO-BOARD CONNECTOR, 0.8mm PITCH, FINE-STACK 3H. PLUG
CHK	S. CHIEN	05FEB2013	
APVD	W. KODAMA	05FEB2013	
PRODUCT SPEC	108-57488		
APPLICATION SPEC	-		RESTRICTED TO
WEIGHT	0	A3 00779	C-1775014

CUSTOMER DRAWING SCALE 7:1 SHEET 1 OF 2 REV G

THIS DRAWING IS UNPUBLISHED. RELEASED FOR PUBLICATION
 © COPYRIGHT - By - ALL RIGHTS RESERVED.

REVISIONS					
P	LTR	DESCRIPTION	DATE	DWN	APVD
-	-	SEE SHEET 1	-	-	-

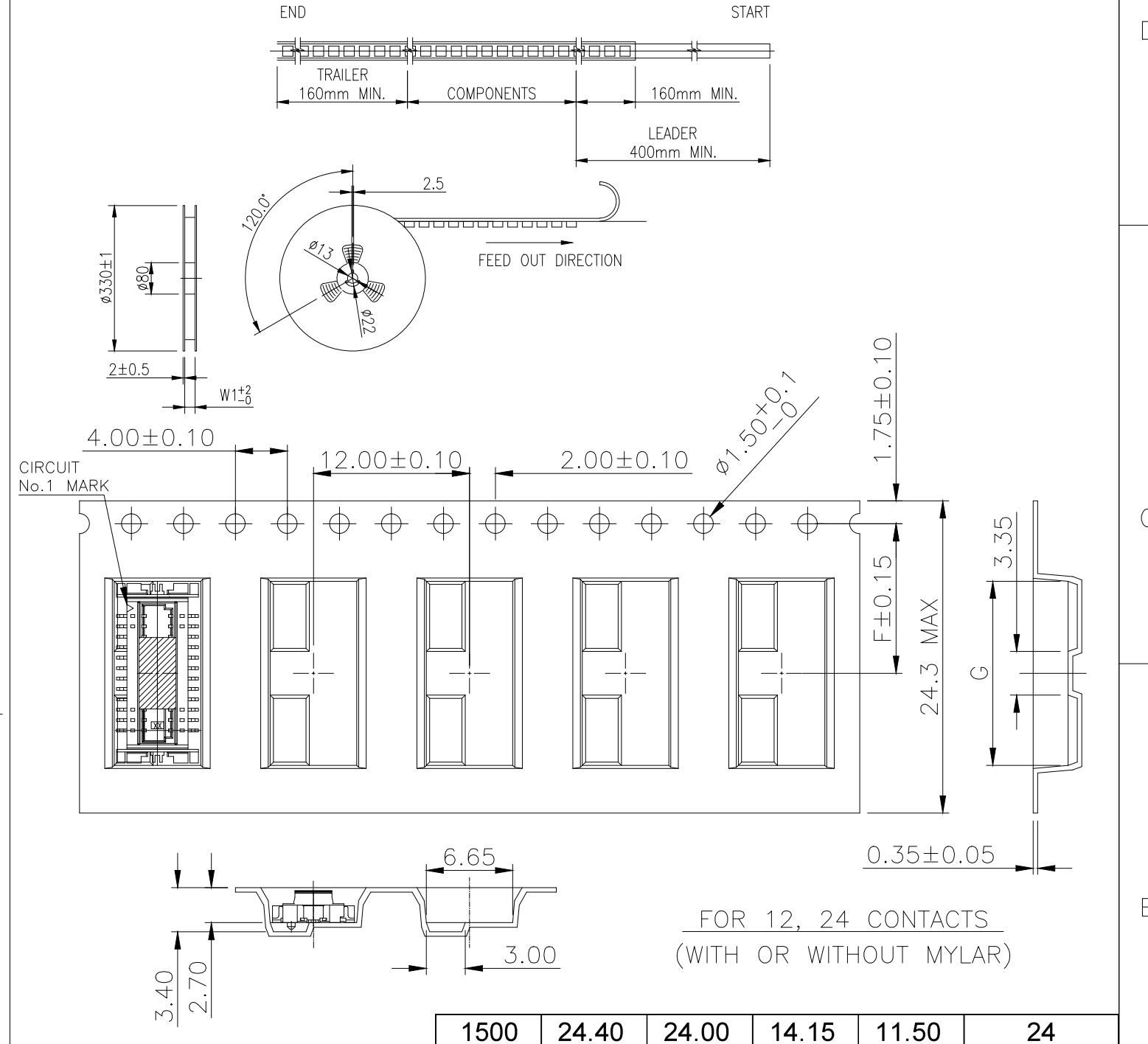
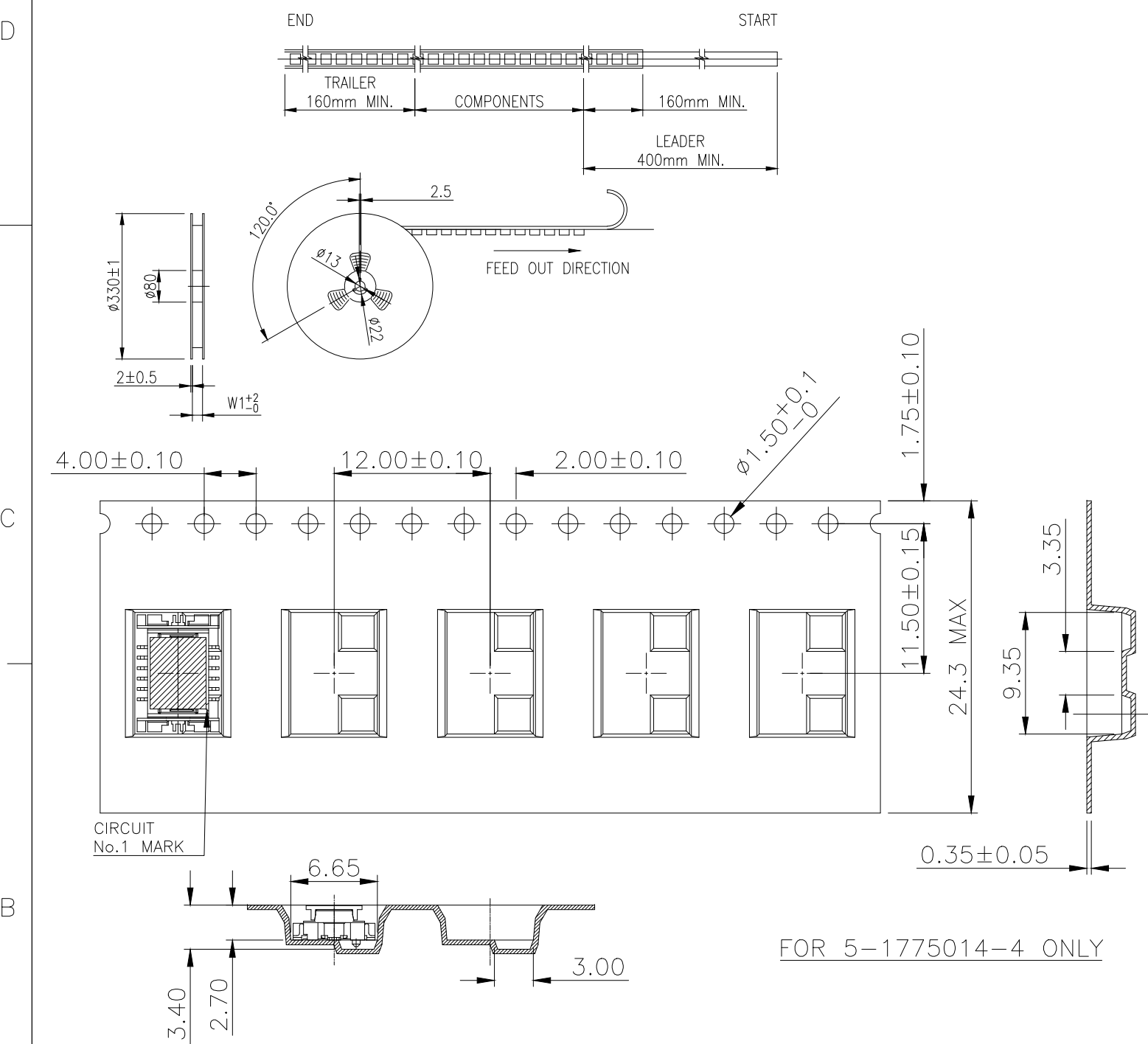

- NOTES:
- MATERIAL:
 BOX: FIBREBOARD, CORRUGATED, DOUBLE WALL.
 COVER TAPE: PET, TRANSPARENT COLOR.
 CARRIER TAPE: POLYSTYRENES, BLACK COLOR.
 REEL: PAPER, BROWN COLOR.
 BAG: POLYETHYLENES, TRANSPARENT COLOR.
 - EACH BAG SHALL BE INCLUDED DESICCANT.
 - PEELING STRENGTH: 0.1~1.3 N (10~130 GRAMS).
 - PEELING SPEED: 300 mm/min.

1500	24.40	24.00	14.15	11.50	24
1500	24.40	24.00	9.35	11.50	12
PCS / TAPE	W1	W	G	F	NO. OF CONTACTS

THIS DRAWING IS A CONTROLLED DOCUMENT.		DWN A. WU 05FEB2013	TE Connectivity BOARD-TO-BOARD CONNECTOR, 0.8mm PITCH, FINE-STACK 3H. PLUG													
DIMENSIONS: mm		CHK S. CHIEN 05FEB2013														
TOLERANCES UNLESS OTHERWISE SPECIFIED:		APVD W. KODAMA 05FEB2013														
<table border="0"> <tr><td>0 PLC</td><td>± -</td></tr> <tr><td>1 PLC</td><td>± 0.3</td></tr> <tr><td>2 PLC</td><td>± 0.2</td></tr> <tr><td>3 PLC</td><td>± 0.15</td></tr> <tr><td>4 PLC</td><td>± -</td></tr> <tr><td>ANGLES</td><td>± 2°</td></tr> <tr><td>FINISH</td><td>-</td></tr> </table>		0 PLC				± -	1 PLC	± 0.3	2 PLC	± 0.2	3 PLC	± 0.15	4 PLC	± -	ANGLES	± 2°
0 PLC	± -															
1 PLC	± 0.3															
2 PLC	± 0.2															
3 PLC	± 0.15															
4 PLC	± -															
ANGLES	± 2°															
FINISH	-															
MATERIAL		PRODUCT SPEC 108-57488	SIZE	CAGE CODE	DRAWING NO	RESTRICTED TO										
-		APPLICATION SPEC -	A3	00779	1775014	-										
CUSTOMER DRAWING			SCALE	SHEET	REV											
-			7:1	2 OF 2	G											

Mouser Electronics

Authorized Distributor

Click to View Pricing, Inventory, Delivery & Lifecycle Information:

[TE Connectivity:](#)

[1775014-2](#)