

PRODUCT NO.  
SEE TABLE

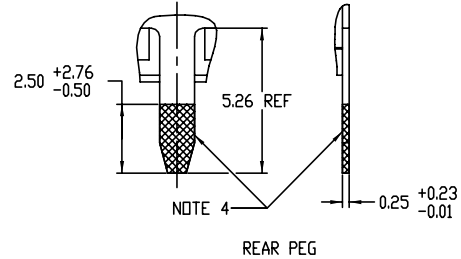
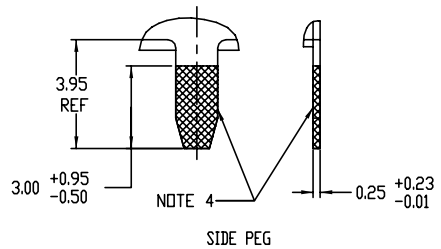
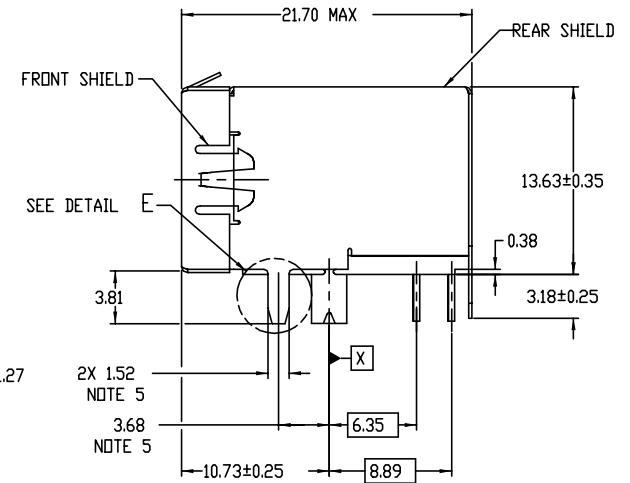
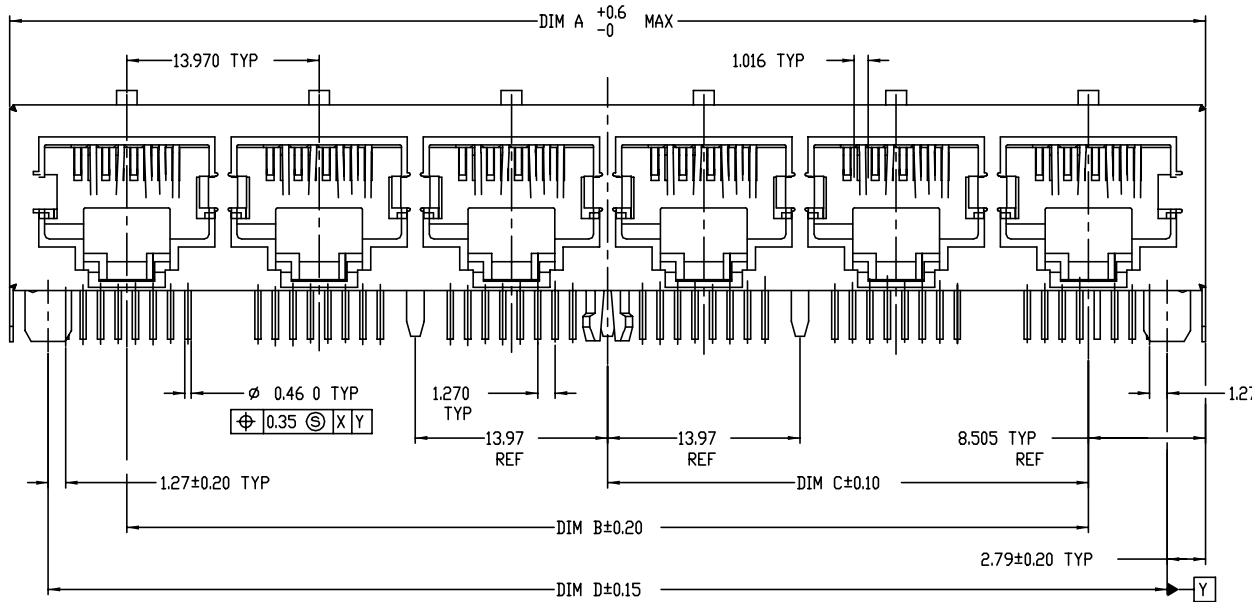
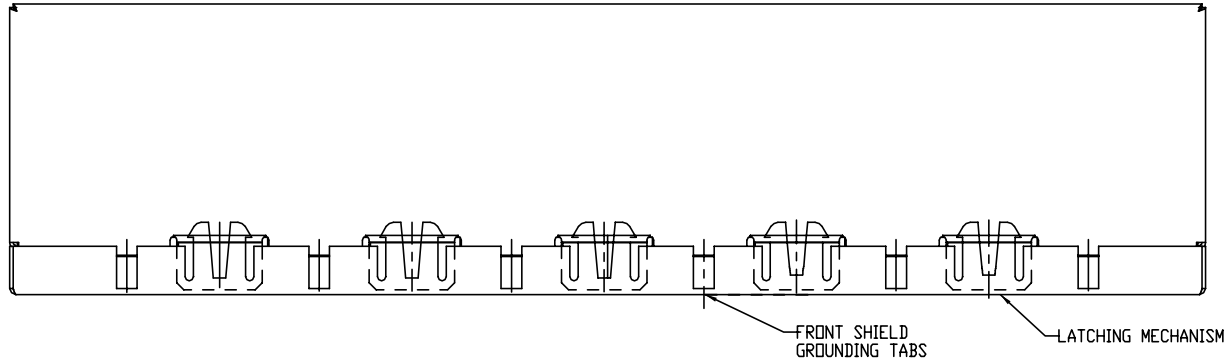

DETAIL E  
SCALE 8:1

mat'l. code		surface		tolerance		projection		product family	
		ISO1302 <input checked="" type="checkbox"/>		ISO1101 ISO406		$\phi$ $\ominus$ $\oplus$		MOD JACK	
l t r e c n n o d r		date		tolerances unless otherwise specified		mm		title	
J	V03-0148	IP	1/30/03	angle	0.X $\pm$ 0.3			R/A CAT 5 GANG JACK ASSY	
K	V03-0231	HTB	04/16/03	0°	0.XX $\pm$ 0.15			8 POS SHIELDED DIAMOND PEG	
L	M04-0176	MHT	8/23/04	0° $\pm$ 2'	0.XXX $\pm$ 0.05	scale 2.0			
M	N04-0043	ZC	10/08/04	dr	L. POTTEIGER	1/30/03			dwg no
N	ELX-N-011008	SH MM	03/14/12	engr	J. KONTOS	1/30/03			sheet 1 of 7
				chr	J. KONTOS	1/30/03			size
				appd	J. KONTOS	1/30/03			A4
								type Product Customer Drawing	
sheet index	revision	N	N	N	N	N	N	N	
	sheet	1	2	3	4	5	6	7	

PRODUCT NO	PORTS NO	DIM A +.60 -.00	DIM B	DIM C±0.10	DIM D±0.15	DIM E±0.13	GROUND LEG NUMBER ON THE BACK (VIEW B)
95676-X01 95676-X01N	1	15.74	—	5.715	11.43	16.16	SEE DIAGRAMS ON SHEET 3
95676-X02YZ 95676-X02NYZ	2	30.98	13.97	12.700	25.40	31.40	
95676-X03YZ 95676-X03NYZ	3	44.95	27.94	19.685	39.37	45.37	
95676-X04YZ 95676-X04NYZ	4	58.92	41.91	26.670	53.34	59.34	
95676-X05YZ 95676-X05NYZ	5	72.89	55.88	33.655	67.31	73.31	
95676-X06YZ 95676-X06NYZ	6	86.86	69.85	40.640	81.28	87.28	
95676-X07YZ 95676-X07NYZ	7	100.83	83.82	47.625	95.25	101.25	
95676-X08YZ 95676-X08NYZ	8	114.80	97.79	54.610	109.22	115.22	
95676-X09YZ 95676-X09NYZ	9	128.77	111.76	61.595	123.19	129.19	
95676-X10YZ 95676-X10NYZ	10	142.74	125.73	68.580	137.16	143.16	
95676-X11YZ 95676-X11NYZ	11	156.71	139.70	75.565	151.13	157.13	
95676-X12YZ 95676-X12NYZ LF	12	170.68	153.67	82.550	165.10	171.10	

SEE NOTE 9

STATEMENT: "THIS PRODUCT MEETS THE REQUIREMENTS OF THE EUROPE UNION DIRECTIVE OF RESTRICTIONS FOR HAZARDOUS SUBSTANCES (DIRECTIVE 2002/95/EC) AND CAN BE PROCESSED IN THE PROCESS CONDITIONS FOR WHICH THE PRODUCT IS DEVELOPED. FCI, ITS SUBSIDIARIES AND AFFILIATES ("FCI") PROVIDES THE ABOVE DATA AND INFORMATION IN GOOD FAITH BASED UPON CURRENT KNOWLEDGE AND EXPERIENCE, BUT MAKE NO WARRANTY THAT SUCH DATA OR INFORMATION IS FREE FROM ERROR, IS COMPLETE OR IS SUFFICIENT FOR USER'S INTENDED PURPOSE EVEN IF MADE KNOWN TO FCI. FCI SPECIFICALLY DISCLAIMS ANY WARRANTY, EXPRESS OR IMPLIED, AND ASSUMES NO LIABILITY WITH RESPECT TO THE EFFECTIVENESS OR SAFETY OF THE PRODUCTS LISTED ABOVE. EACH USER MUST MAKE ITS OWN DETERMINATION AS TO THE SUITABILITY OF FCI'S PRODUCTS AND MATERIALS FOR ITS OWN PARTICULAR PURPOSE, AND MUST ASSURE THAT ITS PRODUCTS FABRICATED FROM FCI'S PRODUCTS AND MATERIALS ARE SAFE AND LAWFULL. IT IS THE USER'S RESPONSIBILITY TO ASSURE PROPER USE AND DISPOSAL OF FCI'S PRODUCTS AND MATERIALS, THE SAFETY AND HEALTH OF USER'S EMPLOYEES AND CUSTOMER, AND USER'S COMPLIANCE WITH APPLICABLE LAWS AND REGULATIONS."

NOTES:

- RECOMMENDED P.C.B THICKNESS 1.60mm
- HOUSING MATERIAL: HIGH TEMP RESIN
- CONTACTS: PHOS BRONZE ALLOY UNS-C51000, Ø0.460 ROUND WIRE, PLATING SEE TABLE.
- SHIELD MATERIAL: BRASS ALLOY 0.25mm THICK  
SHIELD PLATING:  
-FOR 95676-X01 THRU 95676-X12YZ  
BRIGHT TIN LEAD, 100µ" MIN OVER NICKEL.  
-FOR 95676-X01N THRU 95676-X12NYZ  
NICKEL, 30µ" MIN WITH SELECTIVE TIN LEAD  
ON SOLDER TAILS. SEE DETAIL E.  
-FOR LEAD FREE 95676-X01 THRU 95676-X12YZ MATTE TIN  
80µ" MIN. OVER 50µ" NICKEL.  
-FOR LEAD FREE 95676-X01N THRU 95676-X12NYZ WITH  
SELECTIVE MATTE TIN 80µ" MIN.OVER 50µ" NICKEL ON  
SOLDER TAILS. SEE DETAIL E.
- THE HOUSING WILL WITHSTAND EXPOSURE TO 260°C  
PEAK TEMPERATURE FOR 15 SECONDS IN WAVE SOLDER  
APPLICATION WITH A 1.5mm MINIMUM THICK CIRCUIT BOARD.  
SEE APPLICATION NOTES/PROCEDURES IF THEY ARE AVAILABLE.
- PACKAGING MEETS FCI GS-14-920 SPECIFICATION FOR LEAD  
FREE AND ROHS LABELING.
- SPECIALLY FOR ONE-PORT P/N 95676-X0 ONLY.  
SOLDER TAIL OF SHIELD IS 1.02 WIDE, DISTANCE  
FROM PCB PEG TO THE SOLDER TAIL IS 3.05.
- ALL DIMENSIONS IN MILLIMETERS.

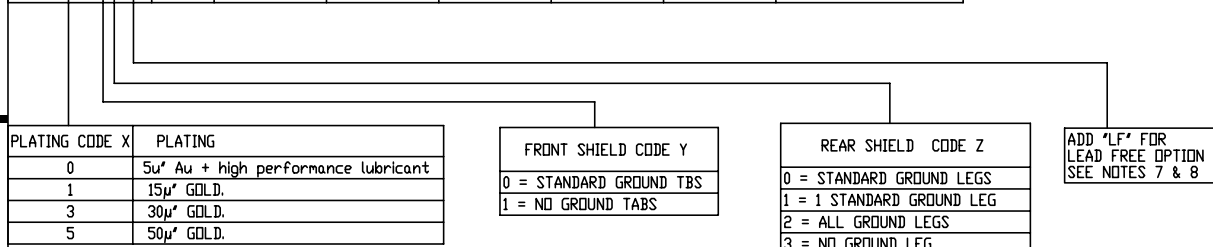

PLATING CODE X	PLATING
0	5µ" Au + high performance lubricant
1	15µ" GOLD.
3	30µ" GOLD.
5	50µ" GOLD.

FRONT SHIELD CODE Y
0 = STANDARD GROUND TABS
1 = NO GROUND TABS

REAR SHIELD CODE Z
0 = STANDARD GROUND LEGS
1 = 1 STANDARD GROUND LEG
2 = ALL GROUND LEGS
3 = NO GROUND LEG

ADD "LF" FOR  
LEAD FREE OPTION  
SEE NOTES 7 & 8

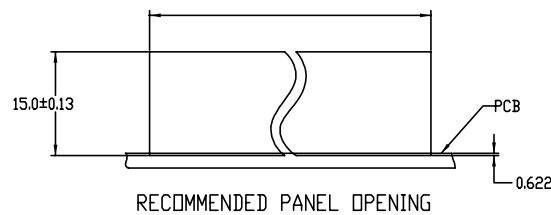

mat'l. code	surface ISO1302 ✓	tolerance ISO1101 ISO406	projection ⊕	product family MOD JACK
ltr ecn nodr date	tolerances unless other wise specified	angle 0.X±0.3 0.XX±0.15 0.XXX±0.05	mm	title R/A CAT 5 GANG JACK ASSY 8 POS SHIELDED DIAMOND PEG
N	dr L. POTTEIGER 1/30/03	scale 2.0	dwg no	sheet 2 of 7 size
	engr J. KONTOS 1/30/03		95676	A4
	chr J. KONTOS 1/30/03		type	Product Customer Drawing
	appd J. KONTOS 1/30/03			
sheet index	revision sheet			

REAR SHIELD (VIEWED FROM PLUG ENTRY SIDE)  
GROUND SOLDER TAIL CONFIGURATION

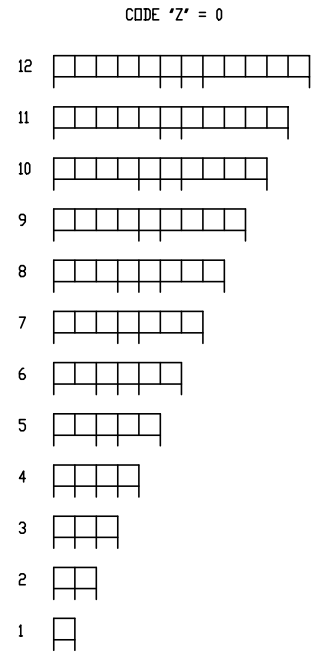

PCB LAYOUT SHEET 4

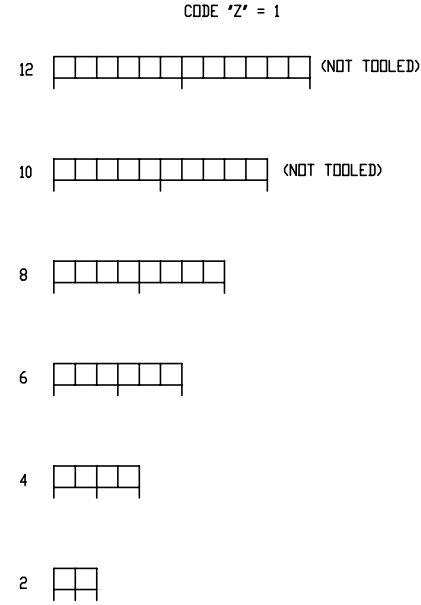

PCB LAYOUT SHEET 5

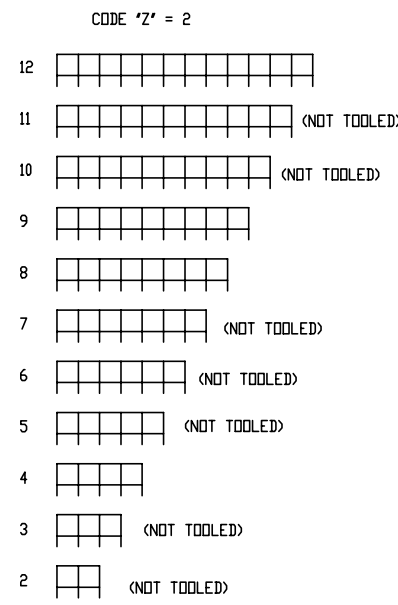

PCB LAYOUT SHEET 6

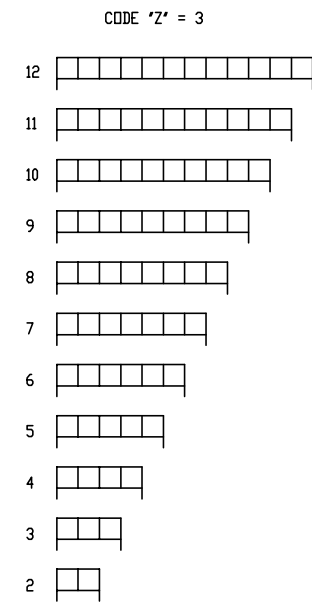

PCB LAYOUT SHEET 7

mat'l. code		surface <input checked="" type="checkbox"/> ISO1302		tolerance <input checked="" type="checkbox"/> ISO1101 <input checked="" type="checkbox"/> ISO406		projection		product family MOD JACK	
ltr		ecrn		no dr		date		tolerances unless otherwise specified	
N		angle		0.X±0.3		mm		R/A CAT 5 GANG JACK ASSY	
		0°±2'		0.XX±0.15		scale		8 POS SHIELDED DIAMOND PEG	
				0.XXX±0.05		2.0		dwg no	
		dr		L. POTTEIGER		1/30/03		sheet 3 of 7	
		enr		J. KONTOS		1/30/03		size	
		chr		J. KONTOS		1/30/03		A4	
		appd		J. KONTOS		1/30/03		type	
sheet		revision						Product Customer Drawing	
index		sheet							

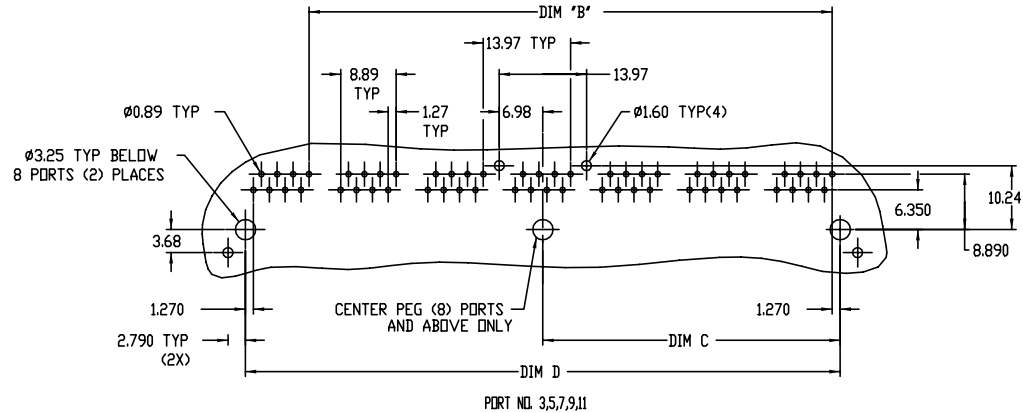
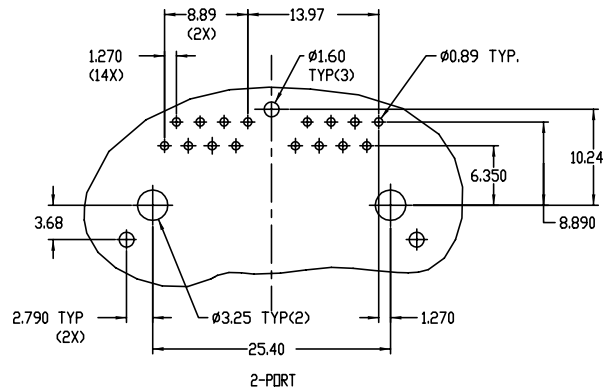
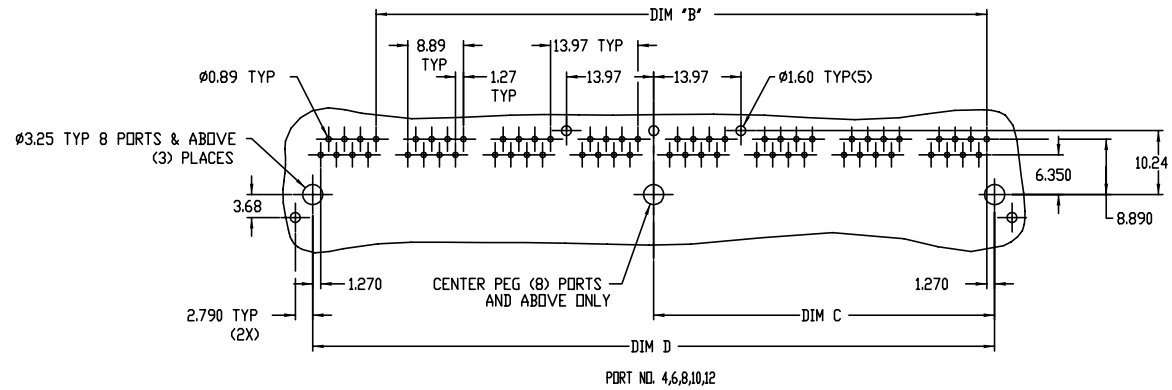
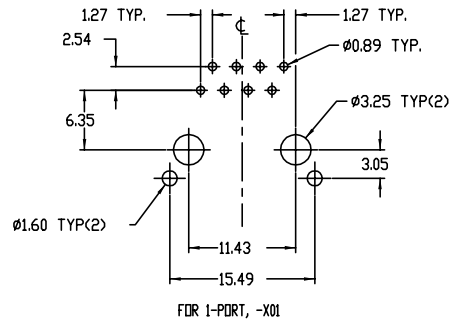

RECOMMENDED P.C.B LAYOUT

CODE 'Z' = 0 (STANDARD GROUND LEG)

mat'l. code	surface	tolerance	projection	product family
	ISO1302	ISO1101 ISO406		MOD JACK
l trechn nodr date	tolerances unless otherwise specified		mm	title
N	angle	0.X±0.3	scale 2.0	R/A CAT 5 GANG JACK ASSY
	0°±2'	0.XX±0.15		8 POS SHIELDED DIAMOND PEG
		0.XXX±0.05		dwg no sheet 4 of 7 size
	dr L. POTTEIGER	1/30/03		95676 A4
	enr J. KONTOS	1/30/03		type Product Customer Drawing
	chr J. KONTOS	1/30/03		
	appd J. KONTOS	1/30/03		
sheet index	revision sheet			

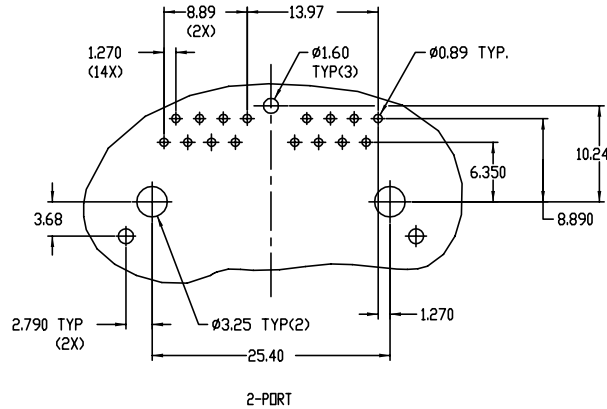
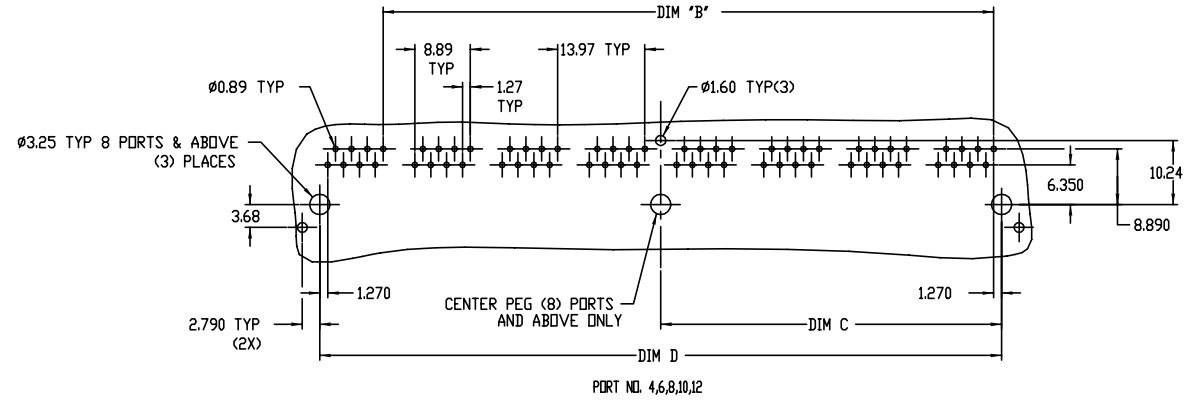

RECOMMENDED P.C.B LAYOUT  
CODE 'Z' = 1 (1 GROUND LEG)

mat'l. code	surface ISO1302	tolerance ISO1101 ISO406	projection mm	product family MOD JACK
ltr ecn nodr date	tolerances unless otherwise specified		scale 2.0	title R/A CAT 5 GANG JACK ASSY 8 POS SHIELDED DIAMOND PEG
N	angle	0.X±0.3 0.XX±0.15 0.XXX±0.05	mm	dwg no 95676
	dr	L. POTTEIGER 1/30/03	FCI	sheet 5 of 7 size A4
	enr	J. KONTOS 1/30/03		type Product Customer Drawing
	chr	J. KONTOS 1/30/03		
	appd	J. KONTOS 1/30/03		
sheet index	revision sheet			

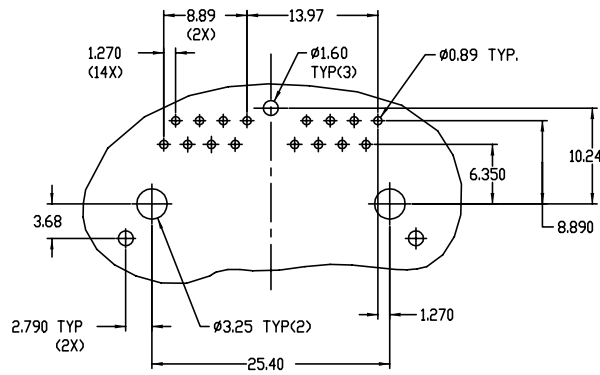
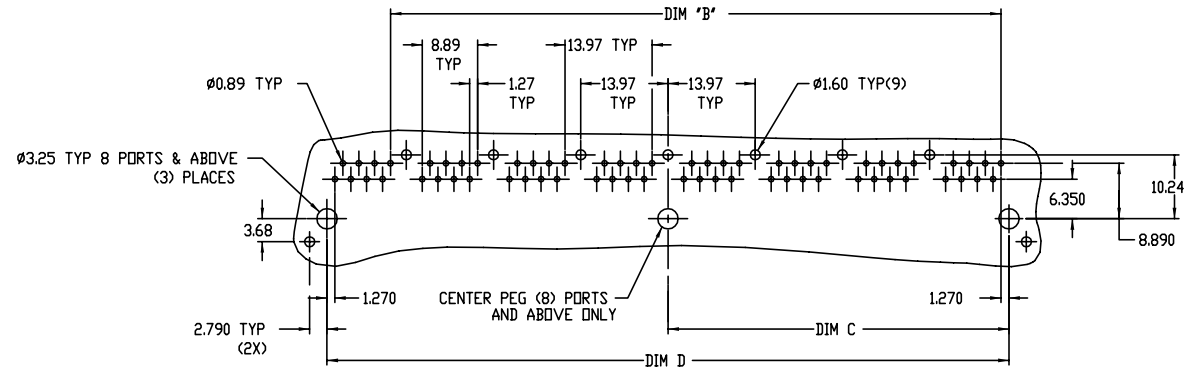

2-PORT  
( SAME AS STANDARD CODE 'Z'= 0 )

RECOMMENDED P.C.B LAYOUT  
CODE 'Z' = 2 (ALL GROUND LEGS)

mat'l. code	surface ISO1302	tolerance ISO1101 ISO406	projection mm	product family MOD JACK
ltr ecn nodr	date	tolerances unless otherwise specified	scale 2.0	title R/A CAT 5 GANG JACK ASSY 8 POS SHIELDED DIAMOND PEG
N		angle 0°±2'	mm	dwg no 95676
		dr L. POTTEIGER 1/30/03		sheet 6 of 7 size A4
		enr J. KONTOS 1/30/03		type Product Customer Drawing
		chr J. KONTOS 1/30/03		
		appd J. KONTOS 1/30/03		
sheet index	revision sheet			

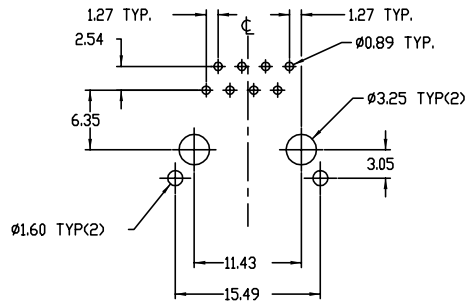
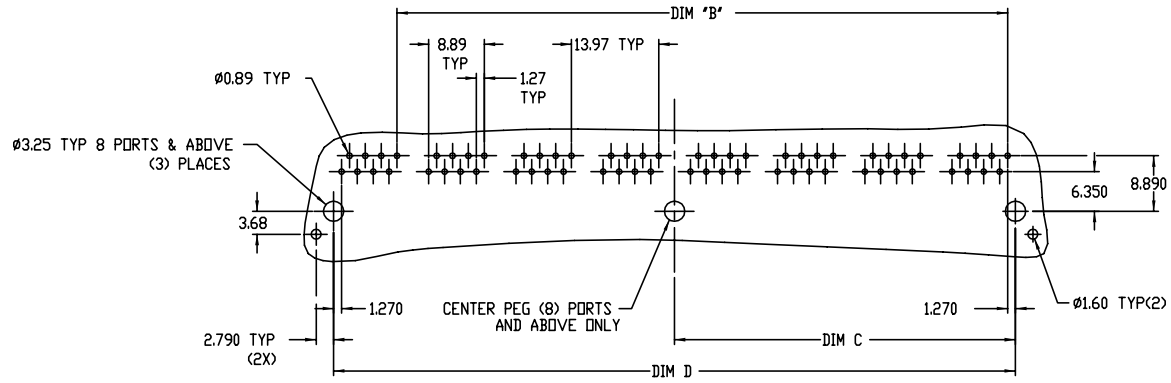

FOR 1-PORT, -X01  
SAME AS STD CODE 'Z'=0

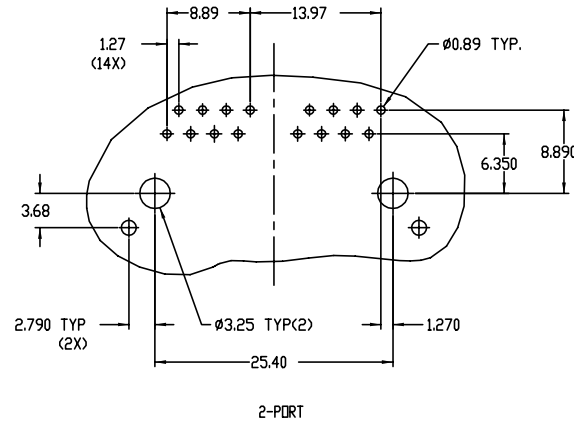

RECOMMENDED P.C.B LAYOUT  
CODE 'Z' = 3 (NO GROUND LEGS)

mat'l. code	surface ISO1302	tolerance ISO1101 ISO406	projection mm	product family MOD JACK
l/tecn nodr date	tolerances unless otherwise specified		scale 2.0	title R/A CAT 5 GANG JACK ASSY 8 POS SHIELDED DIAMOND PEG
N	angle	0.X±0.3 0.XX±0.15 0.XXX±0.05	mm	dwg no 95676
	dr	L. POTTEIGER 1/30/03	FCI	sheet 7 of 7 size A4
	enr	J. KONTOS 1/30/03		type Product Customer Drawing
	chr	J. KONTOS 1/30/03		
	appd	J. KONTOS 1/30/03		
sheet index	revision sheet			

# Mouser Electronics

Authorized Distributor

Click to View Pricing, Inventory, Delivery & Lifecycle Information:

[FCI / Amphenol:](#)

[95678-001LF](#) [95678-101ALF](#) [95678-301ALF](#) [95678-30400LF](#) [95678-001ALF](#) [95676-004-00LF](#) [95676-008LF](#)  
[95676-008N00LF](#) [95678-004N00LF](#) [95678-00800LF](#) [95676-001LF](#) [95676-008N00](#) [95678-00100LF](#) [95678-004-02](#)  
[95678-00410LF](#) [95678-501ALF](#)