

## 53RV Series



- Three-phase Motor Reversing solid-state relay;
- Ratings from 25A and 50A per phase @ 48-530 VAC
- Interlock Circuit Prevents Inadvertent Actuation of Both Directions
- SCR output for heavy industrial loads
- DC control
- LED input status indicator

### PRODUCT SELECTION

Control Voltage	25A	50A
4-32 VDC	D53RV25C	D53RV50C

### AVAILABLE OPTIONS

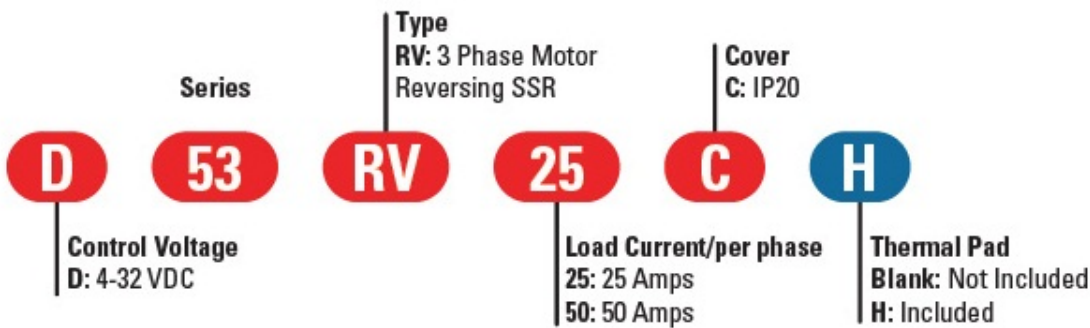

- Required for valid part number
- For options only and not required for valid part number

### OUTPUT SPECIFICATIONS (1)

Description	D53RV25C	D53RV50C
Operating Voltage (47-63Hz) [Vrms]	48-530	48-530
Maximum Load Current [Arms] (2)	25	50
Transient Overvoltage [Vpk]	1100	1100
Maximum Off-State Leakage Current @ Rated Voltage [mArms] (3)	6	6
Minimum Load Current [Arms]	0.1	0.1
Maximum Surge Current 50/60 Hz (16.6ms) [Apk]	475/500	710/750
1 Second Surge Current 50/60 Hz [Apk]	100	150
Maximum On-State Voltage Drop @ Rated Current [Vpk]	1.35	1.35
Maximum I <sup>2</sup> T for Fusing (50/60 Hz, 1/2 cycle) [A <sup>2</sup> sec]	1139/1038	2520/2320
Thermal Resistance Junction to Case [Rjc] [°C/W]	0.26	0.25
Minimum Off-State dv/dt @ Maximum Rated Voltage [V/μsec] (4)	500	500
UL/IEC 60947 Motor Control Ratings @ 120V [HP/KW] (5)	0.75/0.56	1.5/1.11
UL/IEC 60947 Motor Control Ratings @ 240V [HP/KW] (5)	1/0.74	3/2.22
UL/IEC 60947 Motor Control Ratings @ 380V [HP/KW] (5)	2/1.48	5/3.7
UL/IEC 60947 Motor Control Ratings @ 480V [HP/KW] (5)	3/2.22	7.5/5.55

## INPUT SPECIFICATIONS (1)

Description	Parameters
Control Voltage Range	4-32 VDC
Minimum Turn-On Voltage	4.0 VDC
Minimum Turn-Off Voltage	1.0 VDC
Minimum Input Current (for on-state)	23mA
Maximum Input Current	35mA
Input Resistance	Current Regulated
Maximum Turn-On Time [msec]	150
Maximum Turn-Off Time [msec]	1/2 Cycle
Interlocking Time [msec]	100

## GENERAL SPECIFICATIONS

Description	Parameters
Input to Output Isolation	4000 Vrms
Input/ Output to Ground Isolation	2500 Vrms
Maximum Capacitance, Input/Output	8 pF
Ambient Operating Temperature Range	-40 to 80°C
Ambient Storage Temperature Range	-40 to 100 °C
Weight (typical)	13.1 oz (370g)
Housing Material	UL 94V0 (self extinguishing)
Terminals	Mounted
Input Terminal Screw Torque Range:[in lbs/Nm]	16.8/1.9
Output Terminal Screw Torque Range:[in lbs/Nm]	21.2/2.4

## GENERAL NOTES

- 1) All parameters at 25°C unless otherwise specified.
- 2) When mounted to the proper size heat sink (see derating curves)
- 3) Measured between 1/L1 and 2/T1 or 3/L2 and 4/T2
- 4) Off-State dv/dt test method per EIA/NARM standard RS-443, paragraph 13.11.1
- 5) At 40°C Ambient temperature.

## THERMAL DERATE INFORMATION

DERATING CURVES:  
53RV - 25AMP

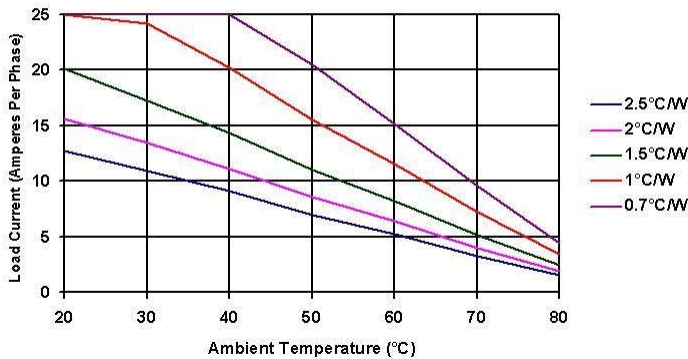

DERATING CURVES:  
53RV - 50AMPS

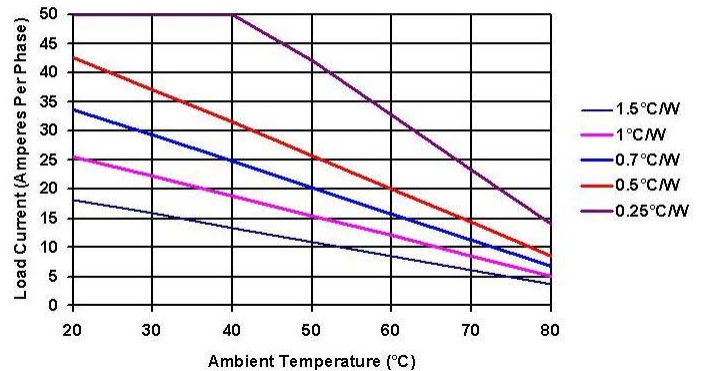

**MECHANICAL SPECIFICATIONS**

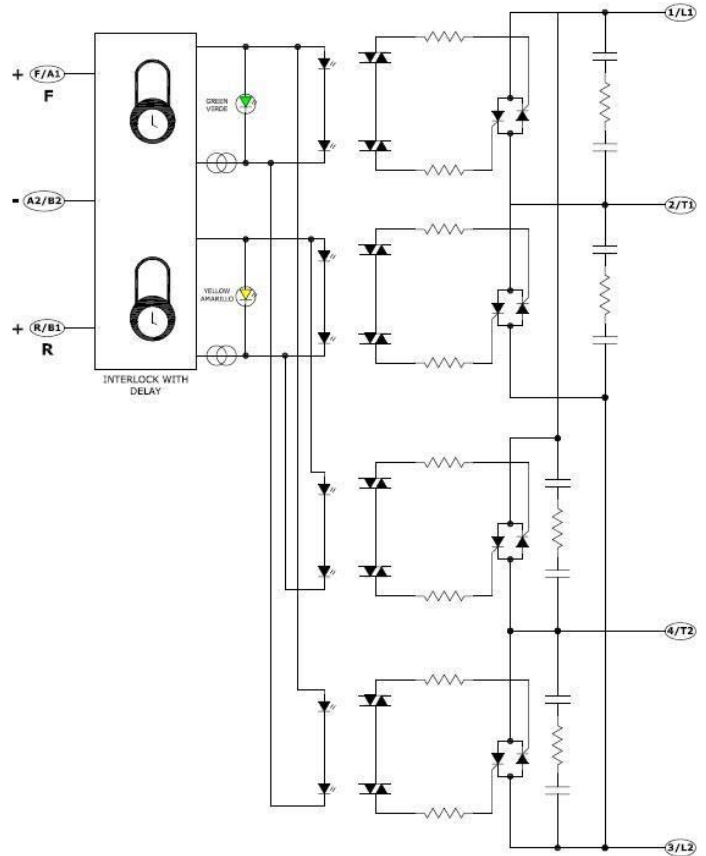
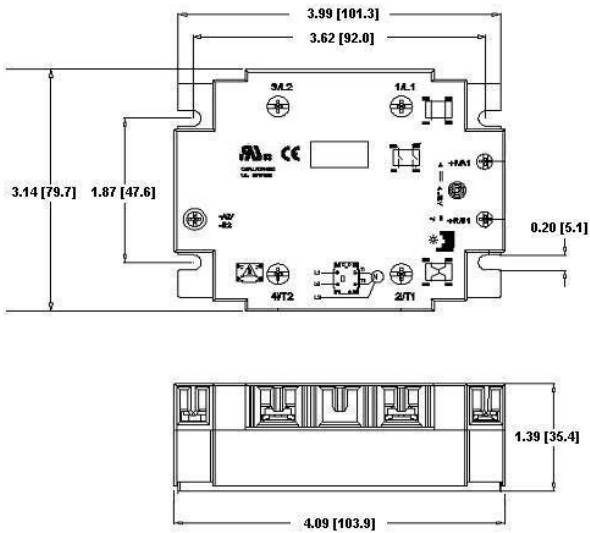



**AGENCY APPROVALS**

Designed in accordance with the requirements of IEC 62314



Rev. 120811

 <b>DANGER / PELIGRO / DANGER /GEFAHR / PERICOLO / PERIGO</b>					
<p><b>HAZARD OF ELECTRIC SHOCK, EXPLOSION, OR ARC FLASH.</b></p> <ul style="list-style-type: none"> <li>• Disconnect all power before installing or working with this equipment.</li> <li>• Verify all connections and replace all covers before turning on power.</li> </ul> <p><b>Failure to follow these instructions will result in death or serious injury.</b></p>	<p><b>RIESGO DE DESCARGA ELECTRICA O EXPLOSION.</b></p> <ul style="list-style-type: none"> <li>• Desconectar todos los suministros de energia a este equipo antes de trabajar con este equipo.</li> <li>• Verificar todas las conexiones y colocar todas las tapas antes de energizar el equipo.</li> </ul> <p><b>EI incumplimiento de estas instrucciones puede provocar la muerte o lesiones serias.</b></p>	<p><b>RISQUE DE DESCARGE ELECTRIQUE OU EXPLOSION</b></p> <ul style="list-style-type: none"> <li>• Eteindre toutes les sources d'énergie de cet appareil avant de travailler dessus de cet appareil</li> <li>• Vérifier tous connections, et remettre tous couverts en olace avant de mettre sous</li> </ul> <p><b>De non-suivi de ces instructions provoquera la mort ou des lésions sérieuses.</b></p>	<p><b>GEFAHR EINES ELEKTRISCHE N SCHLAGES ODER EINER EXPLOSION.</b></p> <ul style="list-style-type: none"> <li>• Stellen Sie jeglichen Strom ab, der dieses Gerät versorgt, bevor Sie an dem Gerät Arbeiten durchführen</li> <li>• Vor der Inbetriebnahme alle Anschlüsse überprüfen und alle Gehäuseteile montieren.</li> </ul> <p><b>Unterlassung dieser Anweisungen können zum Tode oder zu schweren Verletzungen führen.</b></p>	<p><b>RISCHIO DI SCOSSA ELETTRICA O DELL'ESPLOSIONE.</b></p> <ul style="list-style-type: none"> <li>• Spenga tutta l'alimentazion e che fornisce questa apparecchiatura prima del lavorare a questa apparecchiatura</li> <li>• Verificare tutti i collegamenti e sostituire tutte le coperture prima della rotazione sull'alimentazione</li> </ul> <p><b>L'omissione di seguire queste istruzioni provocherà la morte o di lesioni serie</b></p>	<p><b>RISCO DE DESCARGA ELÉTRICA OU EXPLOÇÃO</b></p> <ul style="list-style-type: none"> <li>• Desconectar o equipamento de toda a energia antes de instalar ou trabalhar com este equipamento</li> <li>• Verificar todas as conexões e recolocar todas as tampas antes de religar o equipamento</li> </ul> <p><b>O não cumprimento destas instruções pode levar à morte ou lesões sérias.</b></p>

 <b>WARNING / AVERTISSEMENT / WARNUNG /ADVERTENCIA / AVVERTENZA / AVISO</b>		
<p><b>RISK OF MATERIAL DAMAGE AND HOT ENCLOSURE</b></p> <ul style="list-style-type: none"> <li>• The product's side panels may be hot, allow the product to cool before touching.</li> <li>• Follow proper mounting instructions including torque values.</li> <li>• Do not allow liquids or foreign objects to enter this product.</li> </ul> <p><b>Failure to follow these instructions can result in serious injury, or equipment damage.</b></p>	<p><b>RISQUE DE DOMMAGE MATERIEL ET DE SURCHAUFFE DU BOITIER</b></p> <ul style="list-style-type: none"> <li>• Les panneaux latéraux du produit peuvent être chauds. Laissez le produit refroidir avant de le toucher.</li> <li>• Respecter les consignes de montage, et notamment les couples de serrage.</li> <li>• Ne pas laisser pénétrer de liquide ni de corps étrangers à l'intérieur du produit.</li> </ul> <p><b>Le non-respect de cette directive peut entraîner, des lésions corporelles graves ou des dommages matériels.</b></p>	<p><b>GEFAHR VON MATERIALSCHÄDEN UND GEHÄUSEERHITZUNG</b></p> <ul style="list-style-type: none"> <li>• Die Seitenwände können heiß sein. Lassen Sie das Produkt abkühlen, bevor Sie es berühren.</li> <li>• Beachten Sie die Montageanweisungen,</li> <li>• Führen Sie keine Flüssigkeiten oder Fremdkörper in das Produkt ein.</li> </ul> <p><b>Die Nichtbeachtung dieser Anweisung kann Körperverletzung oder Materialschäden zur Folge haben.</b></p>
<p><b>RIESGO DE DAÑOS MATERIALES Y DE SOBRECIENTAMIENTO DE LA UNIDAD</b></p> <ul style="list-style-type: none"> <li>• Los paneles laterales del producto pueden estar calientes. Esperar que el producto se enfríe antes de tocarlo.</li> <li>• Respetar las instrucciones de montaje, y en particular los pares de apretado.</li> <li>• No dejar que penetren líquidos o cuerpos extraños en el producto.</li> </ul> <p><b>Si no se respetan estas precauciones pueden producirse graves lesiones, daños materiales.</b></p>	<p><b>RISCHIO DI DANNI MATERIALI E D'INVOLUCRO CALDO</b></p> <ul style="list-style-type: none"> <li>• I pannelli laterali dell'apparecchio possono scottare; lasciar quindi raffreddare il prodotto prima di toccarlo.</li> <li>• Seguire le istruzioni di montaggio corrette.</li> <li>• Non far entrare liquidi o oggetti estranei in questo apparecchio.</li> </ul> <p><b>La mancata osservanza di questa precauzione può causare gravi rischi per l'incolumità personale o danni alle apparecchiature.</b></p>	<p><b>RISCO DE DANO MATERIAL E DE AQUECIMENTO</b></p> <ul style="list-style-type: none"> <li>• Os painéis laterais do produto podem estar quentes; dê tempo ao produto para arrefecer antes de lhe tocar.</li> <li>• Siga devidamente as instruções de montagem.</li> <li>• Não permita a entrada de líquidos e de objectos estranhos no produto.</li> </ul> <p><b>A não observância destas precauções pode provocar a morte, ferimentos graves ou danos materiais.</b></p>

**ANNEX - ENVIROMENTAL INFORMATION**

The environmental information disclosed in this annex including the EIP Pollution logo are in compliance with People's Republic of China Electronic Industry Standard SJ/T11364 – 2006, Marking for Control of Pollution Caused by Electronic Information Products.

Part Name	Toxic or hazardous Substance and Elements					
	Lead (Pb)	Mercury (Hg)	Cadmium (Cd)	Hexavalent Chromium (Cr (VI))	Polybrominated biphenyls (PBB)	Polybrominated diphenyl ethers (PBDE)
Semiconductor die	X	O	O	O	O	O
Solder	X	O	O	O	O	O

此附件所标示的包括电子信息产品污染图标的环保信息符合中华人民共和国电子行业标准 **SJ/T11364 - 2006**, 电子信息产品污染控制标识要求



部件名称	有毒有害物质或元素					
	铅 (Pb)	汞 (Hg)	镉 (Cd)	六价铬 (Cr (VI))	多溴联苯 (PBB)	多溴二苯醚 (PBDE)
半导体芯片	X	O	O	O	O	O
焊接点	X	O	O	O	O	O

# Mouser Electronics

Authorized Distributor

Click to View Pricing, Inventory, Delivery & Lifecycle Information:

[Sensata:](#)

[D53RV25C](#) [D53RV25CH](#) [D53RV50C](#) [D53RV50CH](#)