

GSS Series

Global Safety Switch

FEATURES

- EN 50041 and EN 50047 mounting and characteristics
- Designed to IEC electrical standard for world-wide use in guarding applications
- Positive opening operation of NC (Normally Closed) contacts conforming to IEC /EN 60947-5-1-3
- Available with a wide range of positive opening contacts
- Rugged housing (Zinc Die-cast)
- Tamper resistant design uses TORX® head security screw
- Full range of actuator heads and levers suitable for safety applications
- Sealing up to IP 67, NEMA 1, 4, 12 & 13
- Snap action and slow action basic switches
- International conduit sizes
- Galvanically isolated contacts
- UL listed; CSA and CE certified, BG approved
- Red body colour for easy safety recognition

BENEFITS

- Standard mounting and characteristics
- Globally available and accepted
- Welded NC contacts will separate - vital security in safety applications
- Range of actuation methods for detecting safety conditions in guarding and machine status applications
- Wiring and body flexibility
- Suitable for inductive switching and safety relay interfaces
- Signalling and power/safety circuits may be different polarities or voltages
- Immediately recognisable in the application as a safety component

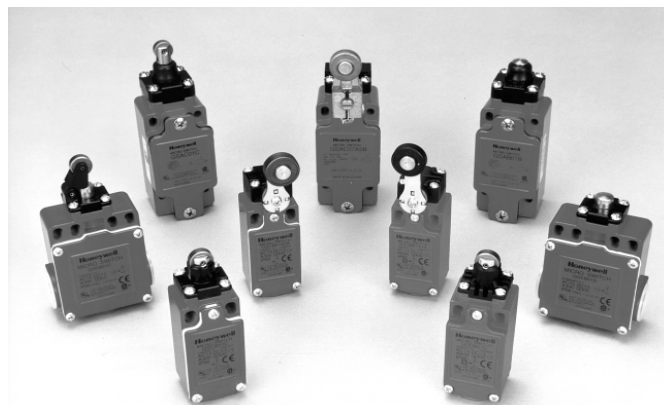

GSS Series products may be used alone as Category 1 per EN 954-1 safety component. In conjunction with other safety switches and our complete range of safety control modules, it is possible to construct comprehensive protection schemes with Category 2, 3 or 4 compliance per EN 954-1.

Honeywell's design experience has resulted in a brand new patented concept in safety switching techniques. The sequential safety switch incorporates positive opening on the downward stroke of each NC sequence point. This allows the user to have both a warning signal and a stop signal. With this information a door can be closed before it stops a machine or settings adjusted to stop excessive movement thus avoiding down time.

LOW ENERGY SWITCHING

In today's demanding age of low energy controls, electromechanical switches are frequently used to interface directly with safety relays, PLCs and other low energy devices. To accommodate this requirement GSS offers gold plated contact versions of the standard basic switch. This improves reliability of switching at low currents and voltages, by protecting the contact surfaces from contamination during operation or storage prior to use.

Standard silver contacts have a disadvantage in that the contact surface may tarnish under certain environmental conditions e.g. in the presence of moisture.

Low energy basic switches are rated as follows:

Operating Voltage U_e	1 to 50 Vac or Vdc
Operating Current I_e	1 μ A to 100 mA

▲ WARNING

MISUSE OF DOCUMENTATION

- The information presented in this product sheet (or catalogue) is for reference only. DO NOT USE this document as system installation information.
- Complete installation, operation and maintenance information is provided in the instructions supplied with each product.

Failure to comply with these instructions could result in death or serious injury.

GSS

GSA EN 50041

Safety Metal Standard

Technical Data

Mechanical life	up to 15 million operations
Degree of protection	IP 67 NEMA/UL type 1, 4, 12, 13
Temperature range	<i>Operating:</i> -25 °C to +85 °C / -13 °F to +185 °F <i>Storage:</i> -40 °C to +85 °C / -40 °F to +185 °F
Approvals*	IEC 60947-5-1 EN 60947-5-1 ac15 A300/A600 dc13 Q300 UL & CSA
Vibration	10 g conforming to IEC 68-2-6
Shock	50 g conforming to IEC 68-2-27
Terminal marking to EN 50013	

*See Standards (page 179)

Dimensions in mm / in

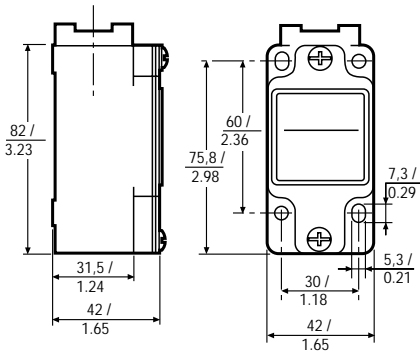

Conduit Thread

A = 1/2" NPT

C = 20 mm

Ordering:

GSA

X

Example: GSA C 01 B

Snap-Action Contacts 1 NORMALLY CLOSED/ 1 NORMALLY OPEN

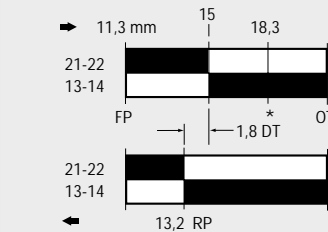
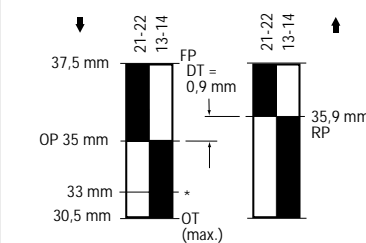
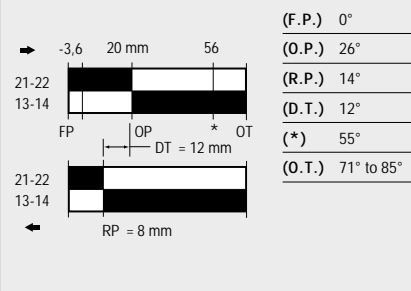
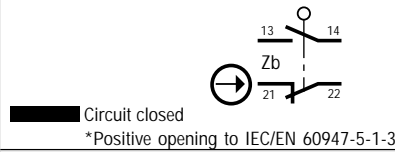

Slow-Action Contacts 2 NORMALLY CLOSED

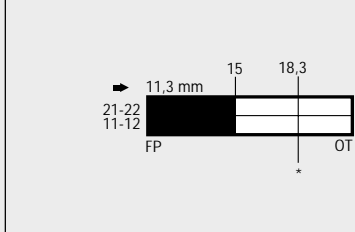
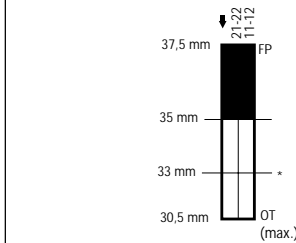
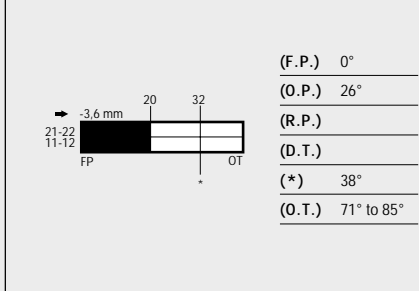
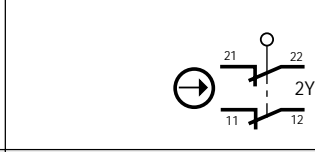

* Point from which the positive opening is assured

** Positive opening occurs at operating position. But to meet IEC/EN 60947-5-3 which requires a dielectric gap of 2,5 kV, positive opening is assured at*.

▲ Low Energy Contacts

Note: See page 197

01

36[▲]

XX

Actuator Types

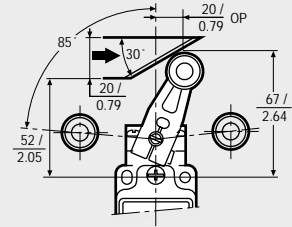

A1B

Additional levers available (see page 208)

Side Rotary, metal roller

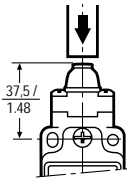

Top pin plunger

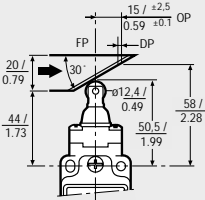

Top roller plunger

B

C

47

XXX

Additional Lever Types

For use with all Side Rotary Head Styles.

Figure 1 illustrates standard lever types which conform to EN 50041. All dimensions are in mm / in

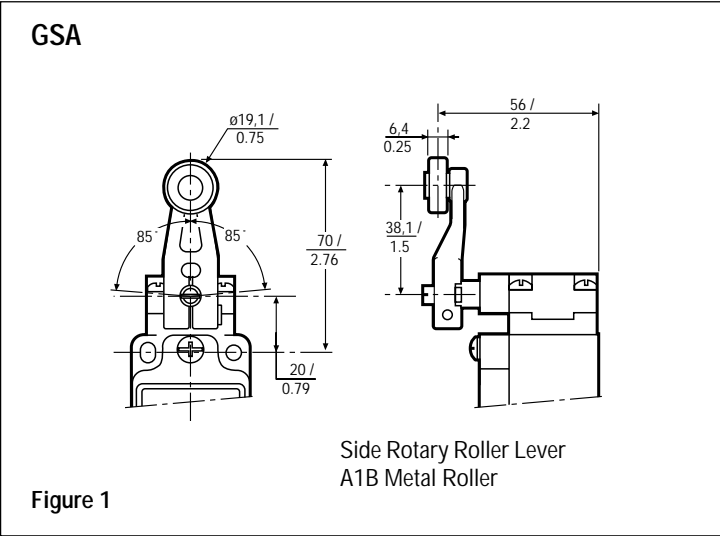

GSS

Slow-Action Contacts
 3 NORMALLY CLOSED/
 1 NORMALLY OPEN
 BREAK BEFORE MAKE

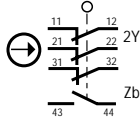

Actuator Types

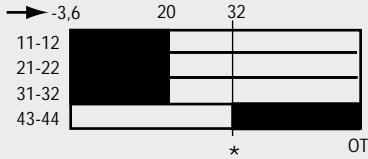

(F.P.) 0°	(R.P.)
(O.P.1) 26°	(D.T.)
(O.P.2) 32°	(*) 38°
	(O.T.) 71° to 85°

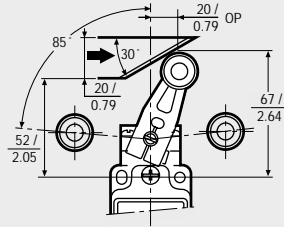

A1B

Side Rotary, metal roller

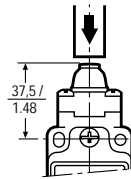
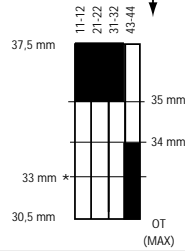

B

Top pin plunger

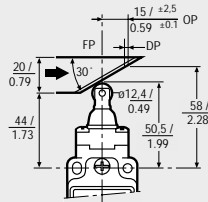
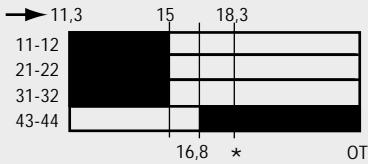

C

Top roller plunger

▲ Low Energy Contacts **47** ▲

Note: See page 197

GS

XXX



GSC EN 50047

Safety Metal Standard

Technical Data

Mechanical life	up to 15 million operations
Degree of protection	IP 66 NEMA/UL type 1, 4, 12, 13
Temperature range	<i>Operating:</i> -25 °C to +85 °C / -13 °F to +185 °F <i>Storage:</i> -40 °C to +85 °C / -40 °F to +185 °F
Approvals*	IEC 60947-5-1 EN 60947-5-1 ac15 A300 dc13 Q300 BG, UL & CSA
Vibration	10 g conforming to IEC 68-2-6
Shock	50 g conforming to IEC 68-2-27
Terminal marking to EN 50013	

*See Standards (page 179)

Dimensions in mm / in

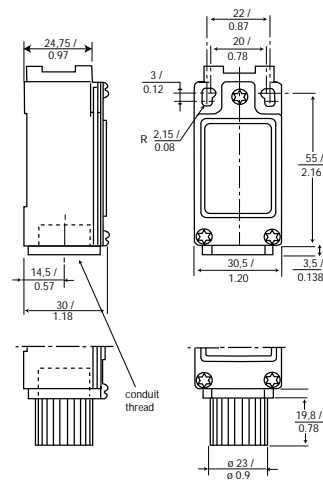

Note: Incorporates safety screws

Conduit Thread
A = 1/2" NPT

C = 20 mm

Ordering:

GSC

X

Example: GSC C 01 B

▲ Low Energy Contacts

Note: See page 197

01

36[▲]

XX

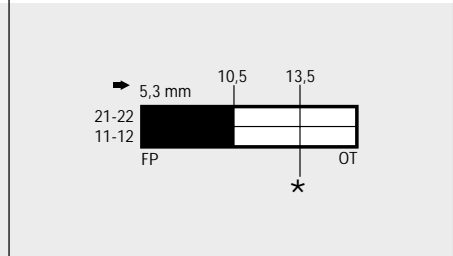
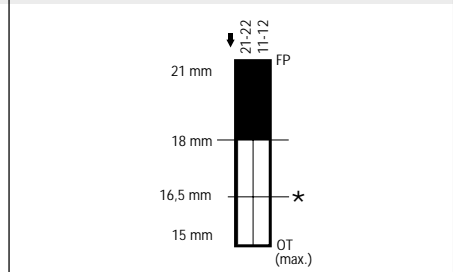
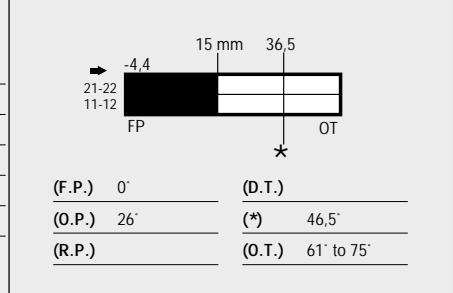
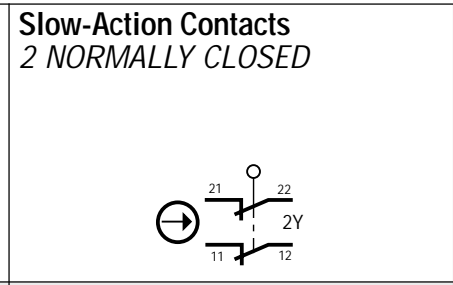
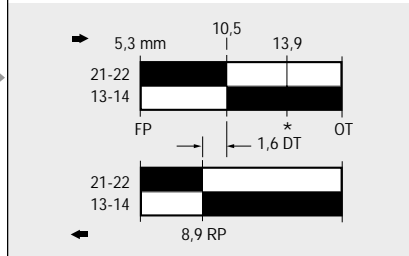
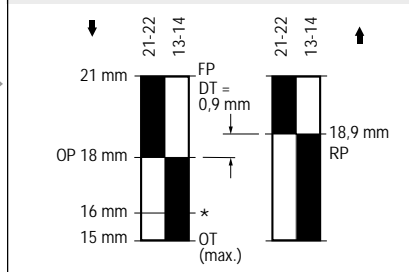
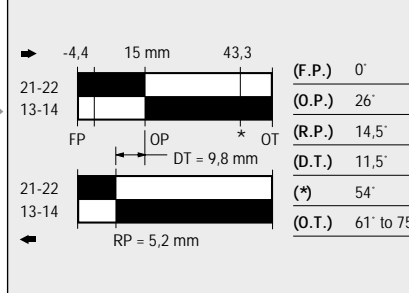
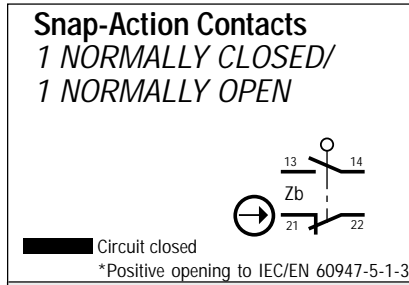

* Point from which the positive opening is assured

** Positive opening occurs at operating position. But to meet IEC/EN 60947-5-3 which requires a dielectric gap of 2,5 kV, positive opening is assured at*.

Actuator Types

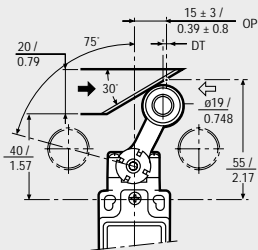

A1B

Additional levers available (see page 208)

Side Rotary, metal roller

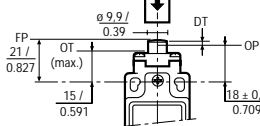

Top pin plunger

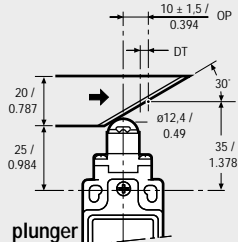

Top roller plunger

B

C

XXX

Additional Lever Types

For use with all Side Rotary Head Styles.
All dimensions are in mm / in

Figure 2 illustrates standard lever types which conform to EN 50047.

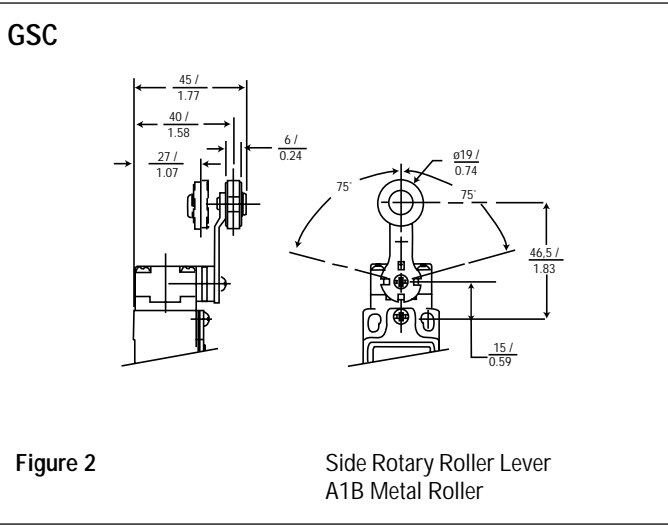

Figure 2

Side Rotary Roller Lever A1B Metal Roller



GSD EN 50047 Safety Double Insulated Standard

Technical Data

Mechanical life	up to 15 million operations
Degree of protection	IP66 NEMA/UL type 1, 12, 13
Temperature range	<i>Operating:</i> -25 °C to +85 °C / -13 °F to +185 °F <i>Storage:</i> -40 °C to +85 °C / -40 °F to +185 °F
Approvals*	IEC 60947-5-1 EN 60947-5-1 ac15 A600 dc13 Q300 BG, UL & CSA
Vibration	10 g conforming to IEC 68-2-6
Shock	50 g conforming to IEC 68-2-27
Terminal marking	to EN 50013

*See Standards (page 179)

Dimensions in mm / in

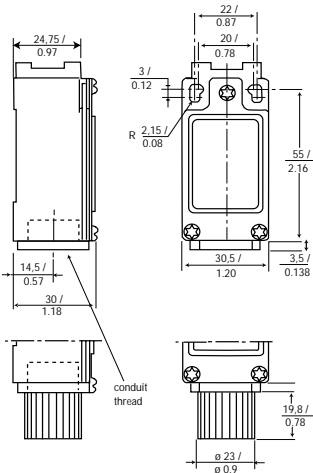

Note: Incorporates safety screws

Conduit Thread
A = 1/2" NPT

C = 20 mm

Ordering:

GSD

X

Example: GSD C 01 B

▲ Low Energy Contacts
Note: See page 197

01

36[▲]

XX

Snap-Action Contacts 1 NORMALLY CLOSED/ 1 NORMALLY OPEN

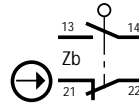

█ Circuit closed
*Positive opening to IEC/EN 60947-5-1-3

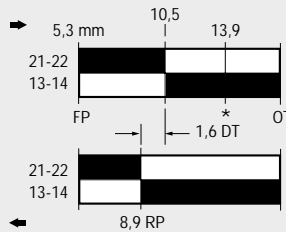
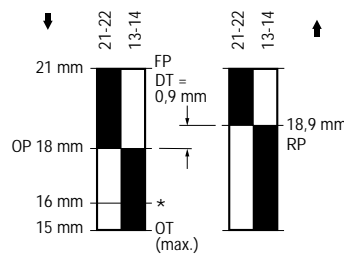
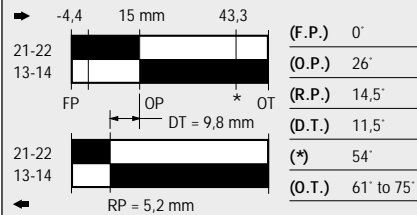

Slow-Action Contacts 2 NORMALLY CLOSED

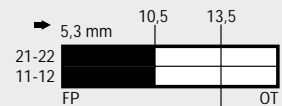
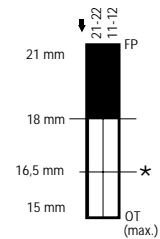
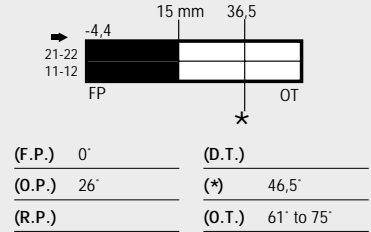
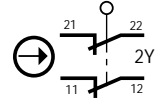

* Point from which the positive opening is assured

** Positive opening occurs at operating position. But to meet IEC/EN 60947-5-3 which requires a dielectric gap of 2,5 kV, positive opening is assured at*.

Actuator Types

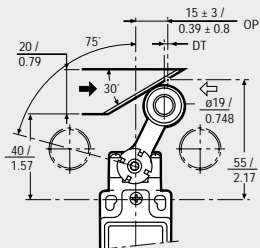

Side Rotary, metal roller

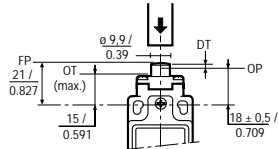

Top pin plunger

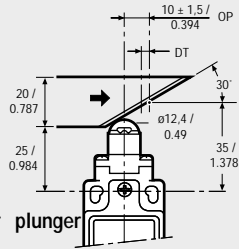

Top roller plunger

A1B

Additional levers available (see page 208)

B

C

XXX

Additional Lever Types

For use with all Side Rotary Head Styles.

All dimensions are in mm / in

Figure 2 illustrates standard lever types which conform to EN 50047.

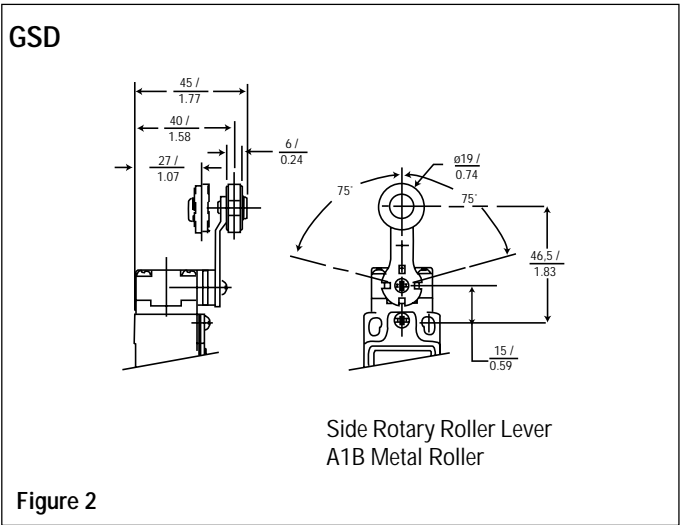

Figure 2



GSE EN 50047 Compatible Safety 3 Conduit Metal Standard

Technical Data

Mechanical life	up to 15 million operations
Degree of protection	IP66 NEMA/UL type 1, 4, 12, 13
Temperature range	<i>Operating:</i> -25 °C to +85 °C / -13 °F to +185 °F <i>Storage:</i> -40 °C to +85 °C / -40 °F to +185 °F
Approvals*	IEC 60947-5-1 EN 60947-5-1 ac15 A300 dc13 Q300 BG, UL & CSA
Vibration	10 g conforming to IEC 68-2-6
Shock	50 g conforming to IEC 68-2-27
Terminal marking	to EN 50013

*See Standards (page 179)

Dimensions in mm / in

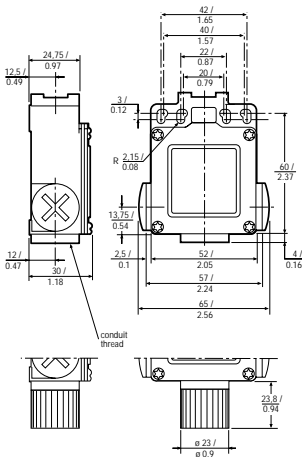

Note: Incorporates safety screws

Conduit Thread

A = 1/2" NPT

C = 20 mm

Ordering:

GSE

X

▲ Low Energy Contacts

47▲

Note: See page 201

XX

XXX

Example: GSE C 20 B

Slow-Action Contacts
3 NORMALLY CLOSED/
1 NORMALLY OPEN
BREAK BEFORE MAKE

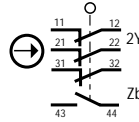

Actuator Types



(F.P.) 0°	(R.P.)
(O.P.1) 26°	(D.T.)
(O.P.2) 32°	(*) 38°
	(O.T.) 71° to 85°

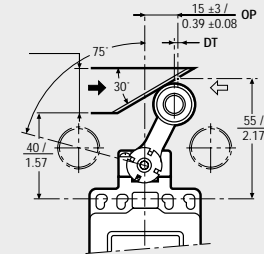
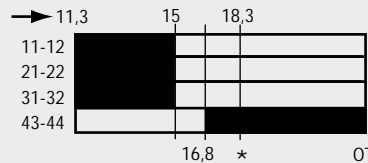
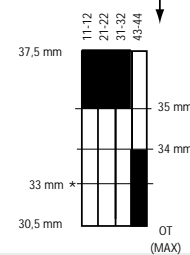

Side Rotary, metal roller

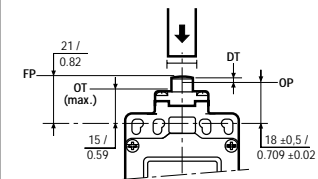

Top pin plunger

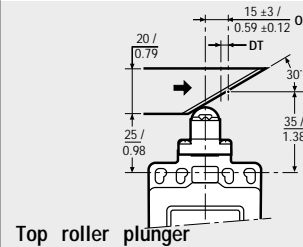

Top roller plunger

* Point from which the positive opening is assured

** Positive opening occurs at operating position. But to meet IEC/EN 60947-5-3 which requires a dielectric gap of 2,5 kV, positive opening is assured at*.

A1B

Additional levers available (see page 208)

B

C

Additional Lever Types

For use with all Side Rotary Head Styles.

All dimensions are in mm / in

Figure 2 illustrates standard lever types which conform to EN 50047.

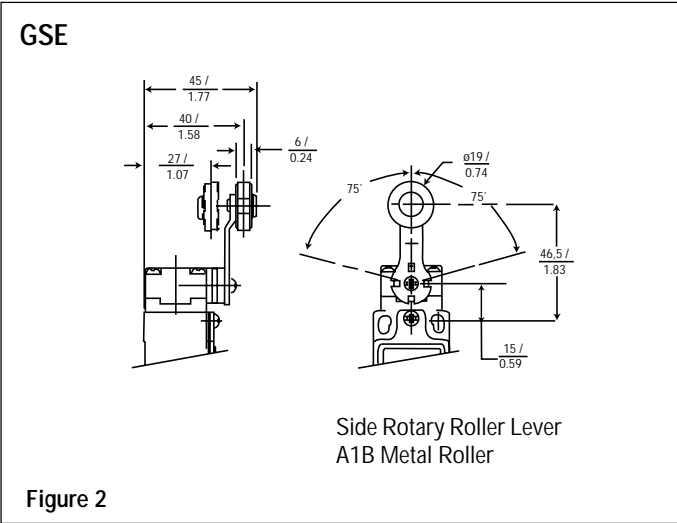

GSS

GSS

Mouser Electronics

Authorized Distributor

Click to View Pricing, Inventory, Delivery & Lifecycle Information:

[Honeywell:](#)

[GSAC01B](#) [GSAC01C](#) [GSAA20A1B-1](#) [GSAC07A1B](#) [GSAC46A1B](#)