

BD136G, BD138G, BD140G

Plastic Medium-Power Silicon PNP Transistors

This series of plastic, medium-power silicon PNP transistors are designed for use as audio amplifiers and drivers utilizing complementary or quasi complementary circuits.

Features

- High DC Current Gain
- BD 136, 138, 140 are complementary with BD 135, 137, 139
- These Devices are Pb-Free, Halogen Free/BFR Free and are RoHS Compliant*

MAXIMUM RATINGS

| Rating | Symbol | Value | Unit |
|---|----------------|-----------------|-------------------------------|
| Collector-Emitter Voltage BD136G BD138G BD140G | V_{CEO} | 45 60 80 | Vdc |
| Collector-Base Voltage BD136G BD138G BD140G | V_{CBO} | 45 60 100 | Vdc |
| Emitter-Base Voltage | V_{EBO} | 5.0 | Vdc |
| Collector Current | I_C | 1.5 | Adc |
| Base Current | I_B | 0.5 | Adc |
| Total Device Dissipation @ $T_A = 25^\circ\text{C}$ Derate above 25°C | P_D | 1.25 10 | Watts mW/ $^\circ\text{C}$ |
| Total Device Dissipation @ $T_C = 25^\circ\text{C}$ Derate above 25°C | P_D | 12.5 100 | Watts mW/ $^\circ\text{C}$ |
| Operating and Storage Junction Temperature Range | T_J, T_{stg} | -55 to +150 | $^\circ\text{C}$ |

Stresses exceeding those listed in the Maximum Ratings table may damage the device. If any of these limits are exceeded, device functionality should not be assumed, damage may occur and reliability may be affected.

THERMAL CHARACTERISTICS

| Characteristic | Symbol | Max | Unit |
|---|-----------------|-----|---------------------------|
| Thermal Resistance, Junction-to-Case | $R_{\theta JC}$ | 10 | $^\circ\text{C}/\text{W}$ |
| Thermal Resistance, Junction-to-Ambient | $R_{\theta JA}$ | 100 | $^\circ\text{C}/\text{W}$ |

*For additional information on our Pb-Free strategy and soldering details, please download the ON Semiconductor Soldering and Mounting Techniques Reference Manual, SOLDERRM/D.



ON Semiconductor®

<http://onsemi.com>

1.5 A POWER TRANSISTORS PNP SILICON 45, 60, 80 V, 12.5 W

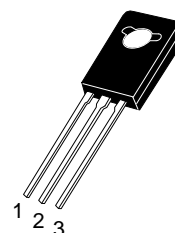
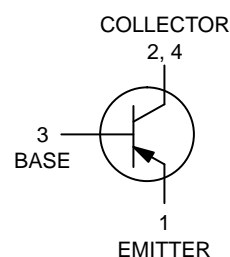

TO-225
CASE 77-09
STYLE 1

MARKING DIAGRAM

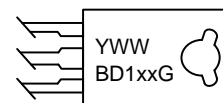

Y = Year
 WW = Work Week
 BD1xx = Device Code
 xx = 36, 38, 40
 G = Pb-Free Package

ORDERING INFORMATION

| Device | Package | Shipping |
|--------|---------------------|---------------|
| BD136G | TO-225 (Pb-Free) | 500 Units/Box |
| BD138G | TO-225 (Pb-Free) | 500 Units/Box |
| BD140G | TO-225 (Pb-Free) | 500 Units/Box |

BD136G, BD138G, BD140G

ELECTRICAL CHARACTERISTICS ($T_C = 25^\circ\text{C}$ unless otherwise noted)

| Characteristic | Symbol | Min | Max | Unit |
|--|-----------------|----------------|---------------|-----------------|
| Collector–Emitter Sustaining Voltage (Note 1) ($I_C = 0.03\text{ A}$, $I_B = 0$) BD136G BD138G BD140G | V_{CEO} | 45 60 80 | – – – | Vdc |
| Collector Cutoff Current ($V_{CB} = 30\text{ Vdc}$, $I_E = 0$) ($V_{CB} = 30\text{ Vdc}$, $I_E = 0$, $T_C = 125^\circ\text{C}$) | I_{CBO} | – – | 0.1 10 | μAdc |
| Emitter Cutoff Current ($V_{BE} = 5.0\text{ Vdc}$, $I_C = 0$) | I_{EBO} | – | 10 | μAdc |
| DC Current Gain ($I_C = 0.005\text{ A}$, $V_{CE} = 2\text{ V}$) ($I_C = 0.15\text{ A}$, $V_{CE} = 2\text{ V}$) ($I_C = 0.5\text{ A}$, $V_{CE} = 2\text{ V}$) | h_{FE}^* | 25 40 25 | – 250 – | – |
| Collector–Emitter Saturation Voltage (Note 1) ($I_C = 0.5\text{ A}$, $I_B = 0.05\text{ A}$) | $V_{CE(sat)}^*$ | – | 0.5 | Vdc |
| Base–Emitter On Voltage (Note 1) ($I_C = 0.5\text{ A}$, $V_{CE} = 2.0\text{ Vdc}$) | $V_{BE(on)}^*$ | – | 1 | Vdc |

Product parametric performance is indicated in the Electrical Characteristics for the listed test conditions, unless otherwise noted. Product performance may not be indicated by the Electrical Characteristics if operated under different conditions.

1. Pulse Test: Pulse Width $\leq 300\ \mu\text{s}$, Duty Cycle $\leq 2.0\%$.

TYPICAL CHARACTERISTICS

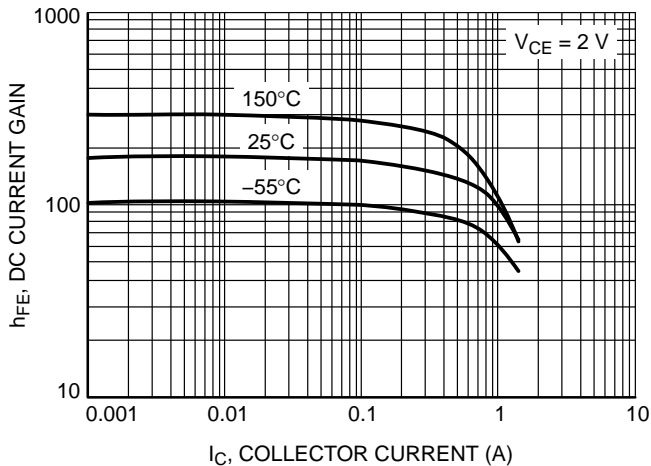

Figure 1. DC Current Gain

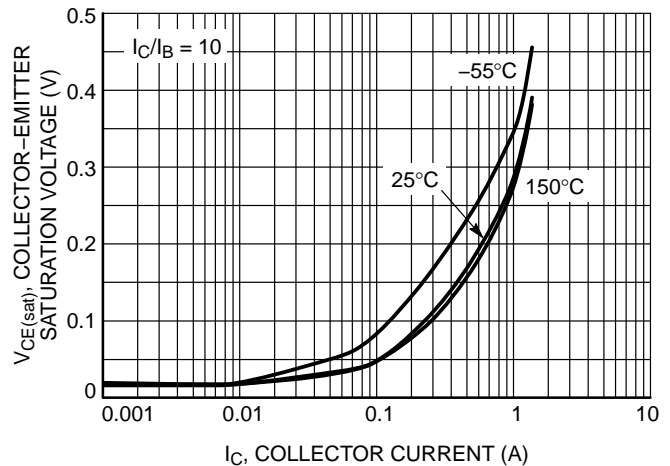

Figure 2. Collector–Emitter Saturation Voltage

BD136G, BD138G, BD140G

TYPICAL CHARACTERISTICS

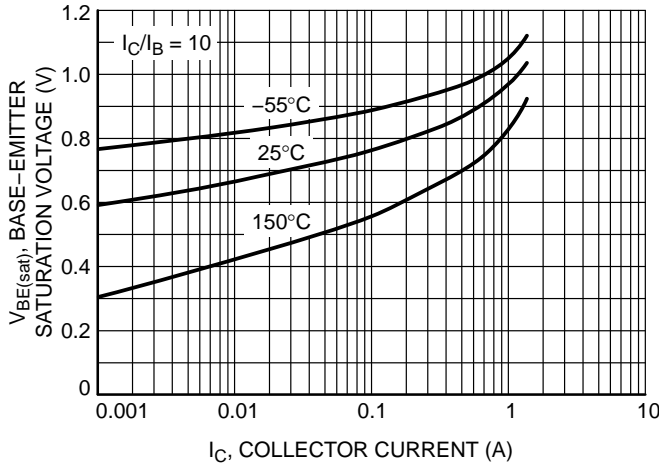

Figure 3. Base-Emitter Saturation Voltage

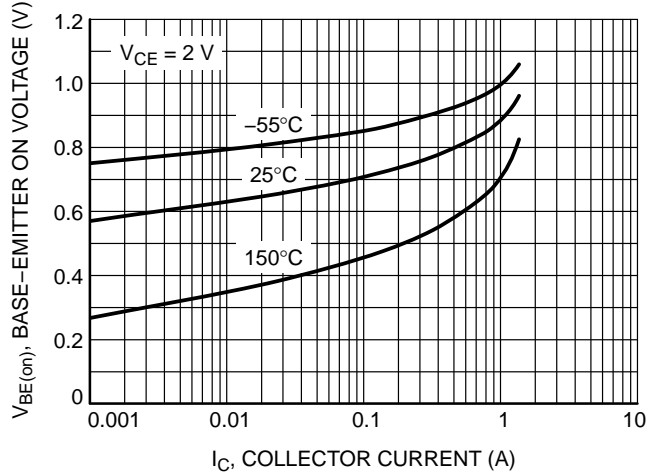

Figure 4. Base-Emitter On Voltage

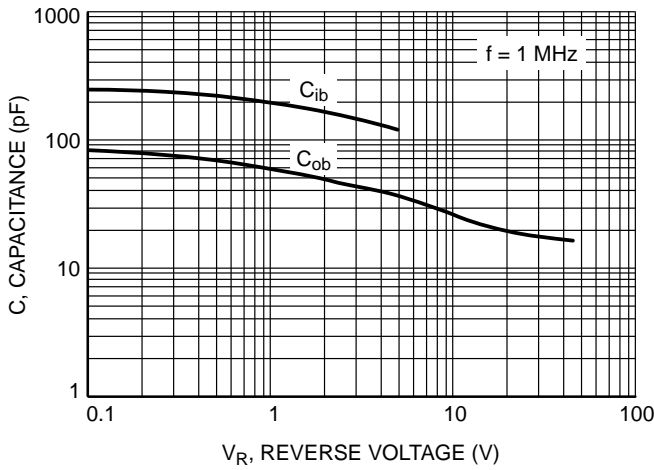

Figure 5. Capacitance

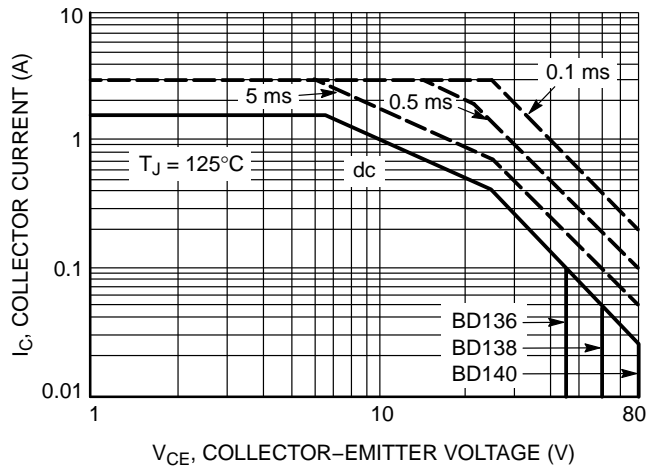

Figure 6. Active-Region Safe Operating Area

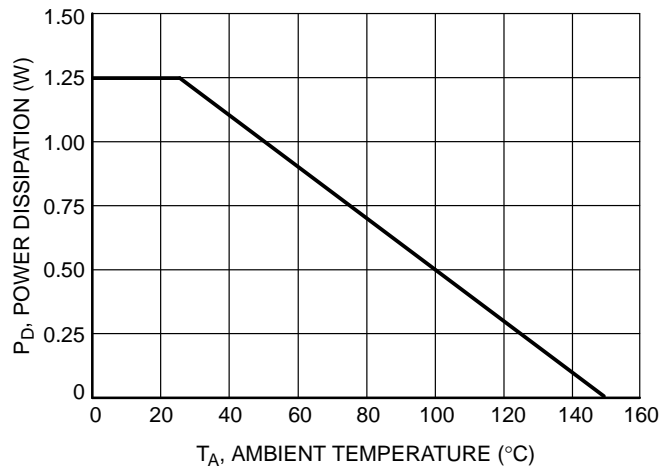
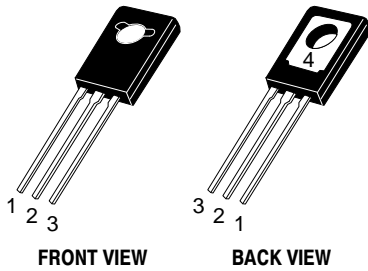

Figure 7. Power Derating

BD136G, BD138G, BD140G

PACKAGE DIMENSIONS



TO-225
CASE 77-09
ISSUE AC

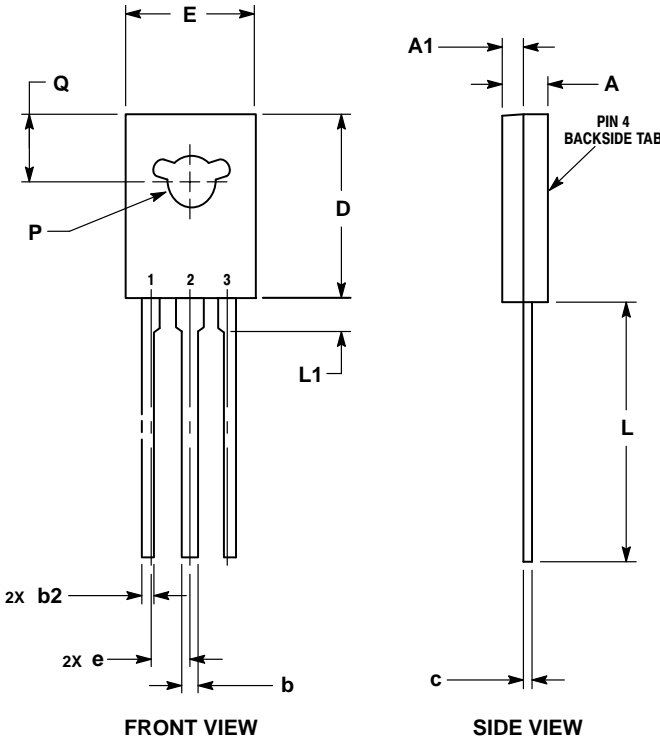

- NOTES:
1. DIMENSIONING AND TOLERANCING PER ASME Y14.5M, 1994.
 2. CONTROLLING DIMENSION: MILLIMETERS.
 3. NUMBER AND SHAPE OF LUGS OPTIONAL.

| DIM | MILLIMETERS | |
|-----|-------------|-------|
| | MIN | MAX |
| A | 2.40 | 3.00 |
| A1 | 1.00 | 1.50 |
| b | 0.60 | 0.90 |
| b2 | 0.51 | 0.88 |
| c | 0.39 | 0.63 |
| D | 10.60 | 11.10 |
| E | 7.40 | 7.80 |
| e | 2.04 | 2.54 |
| L | 14.50 | 16.63 |
| L1 | 1.27 | 2.54 |
| P | 2.90 | 3.30 |
| Q | 3.80 | 4.20 |

- STYLE 1:
PIN 1. EMITTER
2., 4. COLLECTOR
3. BASE

ON Semiconductor and are registered trademarks of Semiconductor Components Industries, LLC (SCILLC). SCILLC owns the rights to a number of patents, trademarks, copyrights, trade secrets, and other intellectual property. A listing of SCILLC's product/patent coverage may be accessed at www.onsemi.com/site/pdf/Patent-Marking.pdf. SCILLC reserves the right to make changes without further notice to any products herein. SCILLC makes no warranty, representation or guarantee regarding the suitability of its products for any particular purpose, nor does SCILLC assume any liability arising out of the application or use of any product or circuit, and specifically disclaims any and all liability, including without limitation special, consequential or incidental damages. "Typical" parameters which may be provided in SCILLC data sheets and/or specifications can and do vary in different applications and actual performance may vary over time. All operating parameters, including "Typicals" must be validated for each customer application by customer's technical experts. SCILLC does not convey any license under its patent rights nor the rights of others. SCILLC products are not designed, intended, or authorized for use as components in systems intended for surgical implant into the body, or other applications intended to support or sustain life, or for any other application in which the failure of the SCILLC product could create a situation where personal injury or death may occur. Should Buyer purchase or use SCILLC products for any such unintended or unauthorized application, Buyer shall indemnify and hold SCILLC and its officers, employees, subsidiaries, affiliates, and distributors harmless against all claims, costs, damages, and expenses, and reasonable attorney fees arising out of, directly or indirectly, any claim of personal injury or death associated with such unintended or unauthorized use, even if such claim alleges that SCILLC was negligent regarding the design or manufacture of the part. SCILLC is an Equal Opportunity/Affirmative Action Employer. This literature is subject to all applicable copyright laws and is not for resale in any manner.

PUBLICATION ORDERING INFORMATION

LITERATURE FULFILLMENT:
Literature Distribution Center for ON Semiconductor
P.O. Box 5163, Denver, Colorado 80217 USA
Phone: 303-675-2175 or 800-344-3860 Toll Free USA/Canada
Fax: 303-675-2176 or 800-344-3867 Toll Free USA/Canada
Email: orderlit@onsemi.com

N. American Technical Support: 800-282-9855 Toll Free
USA/Canada
Europe, Middle East and Africa Technical Support:
Phone: 421 33 790 2910
Japan Customer Focus Center
Phone: 81-3-5817-1050

ON Semiconductor Website: www.onsemi.com
Order Literature: <http://www.onsemi.com/orderlit>
For additional information, please contact your local Sales Representative

Mouser Electronics

Authorized Distributor

Click to View Pricing, Inventory, Delivery & Lifecycle Information:

[ON Semiconductor:](#)

[BD136](#) [BD138](#) [BD140](#)