

Operational Amplifiers

Low Noise Operational Amplifiers

BA4560xxx BA4560Rxxx BA4564RFV BA4564WV

General Description

BA4560xxx for normal grade and BA4560Rxxx, BA4564RFV, BA4564WV for high-reliability grade integrate two or four high voltage gain Op-Amps on a single chip. Especially, this series is suitable for any audio applications due to low noise and low distortion characteristics and they are usable for other many applications of wide operating supply voltage range. BA4560Rxxx, BA4564RFV, BA4564WV are high-reliability products with extended operating temperature range.

Features

- High Voltage Gain, Low Noise, Low Distortion
- Wide Operating Supply Voltage Range
- Wide Operating Temperature Range

Packages

Packages	W(Typ) x D(Typ) x H(Max)
SOP8	5.00mm x 6.20mm x 1.71mm
SOP-J8	4.90mm x 6.00mm x 1.65mm
TSSOP-B8	3.00mm x 6.40mm x 1.20mm
MSOP8	2.90mm x 4.00mm x 0.90mm
SOP14	8.70mm x 6.20mm x 1.71mm
SSOP-B14	5.00mm x 6.40mm x 1.35mm

Key Specification

- Operating Supply Voltage (Split Supply): ±4V to ±15V
- Temperature Range:
 - BA4560xxx -40°C to +85°C
 - BA4560Rxxx, BA4564RFV, BA4564WV -40°C to +105°C
- Slew Rate: 4V/μs(Typ)
- Total Harmonic Distortion: 0.003%(Typ)
- Input Referred Noise Voltage: 8 nV/√Hz (Typ)
- Offset Voltage: BA4564WV 2.5mV(Max)

Selection Guide

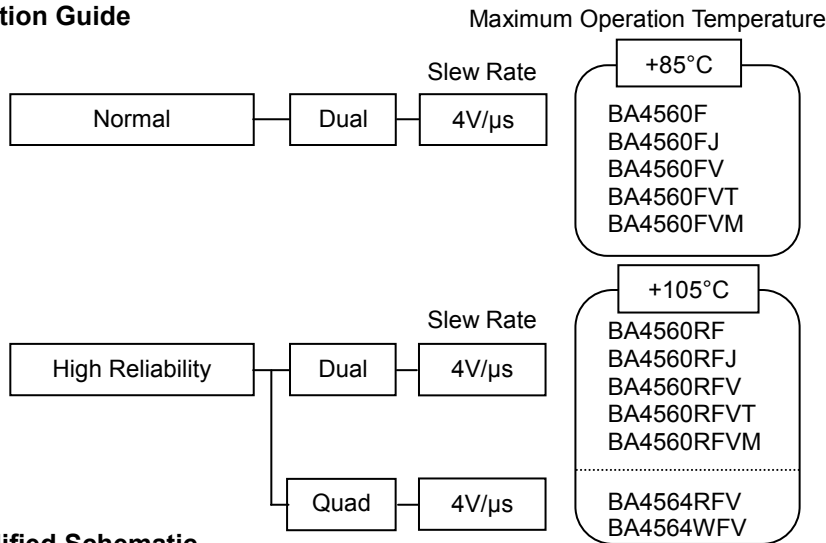

Simplified Schematic

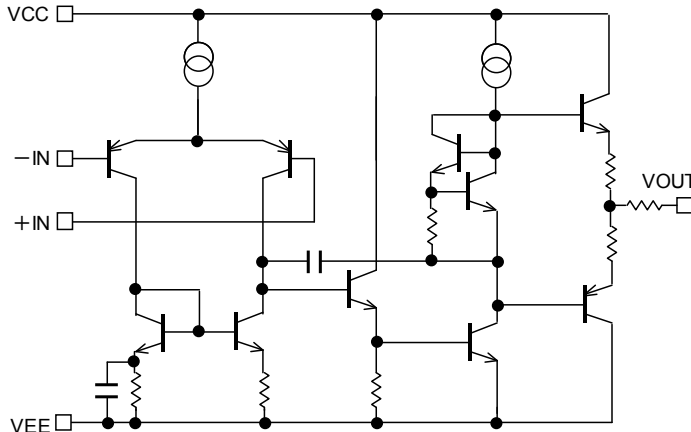
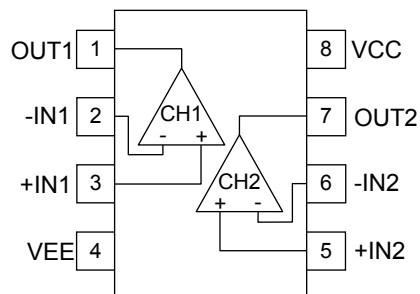

Figure 1. Simplified Schematic

○Product structure : Silicon monolithic integrated circuit ○This product is not designed protection against radioactive rays.

Pin Configuration

BA4560F, BA4560RF : SOP8
 BA4560FJ, BA4560RFJ : SOP-J8
 BA4560FV, BA4560RFV : SSOP-B8
 BA4560FVT, BA4560RFVT : TSSOP-B8
 BA4560FVM, BA4560RFVM : MSOP8



Pin No.	Pin Name
1	OUT1
2	-IN1
3	+IN1
4	VEE
5	+IN2
6	-IN2
7	OUT2
8	VCC

BA4564RFV, BA4564WFV : SSOP-B14

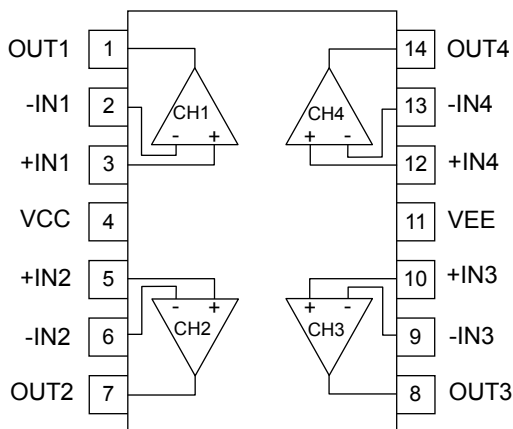

Pin No.	Pin Name
1	OUT1
2	-IN1
3	+IN1
4	VCC
5	+IN2
6	-IN2
7	OUT2
8	OUT3
9	-IN3
10	+IN3
11	VEE
12	+IN4
13	-IN4
14	OUT4

Package					
SOP8	SOP-J8	SSOP-B8	TSSOP-B8	MSOP8	SSOP-B14
BA4560F BA4560RF	BA4560FJ BA4560RFJ	BA4560FV BA4560RFV	BA4560FVT BA4560RFVT	BA4560FVM BA4560RFVM	BA4564RFV BA4564WFV

Ordering Information

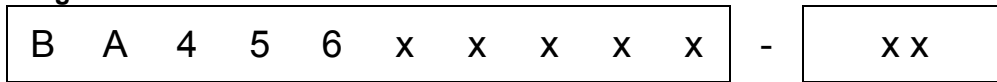

Part Number
 BA4560xxx
 BA4560Rxxx
 BA4564RFV
 BA4560WV

Package
 F : SOP8
 FJ : SOP-J8
 FV : SSOP-B8
 : SSOP-B14
 FVM : MSOP8
 FVT : TSSOP-B8

Packaging and forming specification
 E2: Embossed tape and reel
 (SOP8/SSOP-B8/TSSOP-B8/SOP-J8
 SSOP-B14)
 TR: Embossed tape and reel
 (MSOP8)

Line-up

Operating Temperature Range	Operating Supply Voltage (Split Supply)	Supply Current (Typ)	Offset Voltage (Max)	Package		Orderable Part Number					
-40°C to +85°C	±4.0V to ±15.0V	4mA	6mV	SOP8	Reel of 2500	BA4560F-E2					
				SOP-J8	Reel of 2500	BA4560FJ-E2					
				SSOP-B8	Reel of 2500	BA4560FV-E2					
				TSSOP-B8	Reel of 2500	BA4560FVT-E2					
				MSOP8	Reel of 3000	BA4560FVM-TR					
-40°C to +105°C				3mA		SOP8	Reel of 2500	BA4560RF-E2			
						SOP-J8	Reel of 2500	BA4560RFJ-E2			
						SSOP-B8	Reel of 2500	BA4560RFV-E2			
						TSSOP-B8	Reel of 3000	BA4560RFVT-E2			
				6mA				MSOP8	Reel of 3000	BA4560RFVM-TR	
	SSOP-B14		Reel of 2500					BA4564RFV-E2			
	2.5mV								SSOP-B14	Reel of 2500	BA4564WV-E2

Absolute Maximum Ratings ($T_A=25^\circ\text{C}$)

Parameter	Symbol	Ratings				Unit	
		BA4560xxx	BA4560Rxxx	BA4564RFV	BA4564WV		
Supply Voltage	VCC-VEE	+36				V	
Power Dissipation	P_D	SOP8	0.55 ^(Note1,6)	0.69 ^(Note1,6)	-	-	W
		SOP-J8	0.54 ^(Note2,6)	0.67 ^(Note2,6)	-	-	
		SSOP-B8	0.50 ^(Note3,6)	0.62 ^(Note3,6)	-	-	
		TSSOP-B8	0.50 ^(Note3,6)	0.62 ^(Note3,6)	-	-	
		MSOP8	0.47 ^(Note4,6)	0.58 ^(Note4,6)	-	-	
		SSOP-B14	-	-	0.87 ^(Note5,6)	0.87 ^(Note5,6)	
Differential Input Voltage ^(Note 7)	V_{ID}	VCC-VEE	+36			V	
Input Common-mode Voltage Range	V_{ICM}	VEE to VCC	(VEE-0.3) to VEE+36			V	
Input Current ^(Note 8)	I_I	-10				mA	
Operating Supply Voltage Range	V_{opr}	+8 to +30 (± 4 to ± 15)				V	
Operating Temperature Range	T_{opr}	-40 to +85	-40 to +105			$^\circ\text{C}$	
Storage Temperature Range	T_{stg}	-55 to +125	-55 to +150			$^\circ\text{C}$	
Maximum Junction Temperature	T_{JMAX}	+125	+150			$^\circ\text{C}$	

Note: Absolute maximum rating item indicates the condition which must not be exceeded.

Application of voltage in excess of absolute maximum rating or use out absolute maximum rated temperature environment may cause deterioration of characteristics.

(Note 1) To use at temperature above $T_A=25^\circ\text{C}$ reduce 5.5mW.

(Note 2) To use at temperature above $T_A=25^\circ\text{C}$ reduce 5.4mW.

(Note 3) To use at temperature above $T_A=25^\circ\text{C}$ reduce 5.0mW.

(Note 4) To use at temperature above $T_A=25^\circ\text{C}$ reduce 4.7mW.

(Note 5) To use at temperature above $T_A=25^\circ\text{C}$ reduce 7.0mW.

(Note 6) Mounted on a FR4 glass epoxy PCB(70mm×70mm×1.6mm).

(Note 7) The voltage difference between inverting input and non-inverting input is the differential input voltage.
Then input terminal voltage is set to more than VEE.

(Note 8) An excessive input current will flow when input voltages of less than VEE-0.6V are applied.
The input current can be set to less than the rated current by adding a limiting resistor.

Caution: Operating the IC over the absolute maximum ratings may damage the IC. In addition, it is impossible to predict all destructive situations such as short-circuit modes, open circuit modes, etc. Therefore, it is important to consider circuit protection measures, like adding a fuse, in case the IC is operated in a special mode exceeding the absolute maximum ratings.

Electrical Characteristics

OBA4560xxx (Unless otherwise specified VCC=+15V, VEE=-15V)

Parameter	Symbol	Temperature Range	Limits			Unit	Condition
			Min	Typ	Max		
Input Offset Voltage ^(Note 9)	V _{IO}	25°C	-	0.5	6	mV	V _{OUT} =0V
Input Offset Current ^(Note 9)	I _{IO}	25°C	-	5	200	nA	V _{OUT} =0V
Input Bias Current ^(Note 10)	I _B	25°C	-	50	500	nA	V _{OUT} =0V
Supply Current	I _{CC}	25°C	-	4	7.5	mA	R _L =∞, All Op-Amps, V _{IN} =0V
Maximum Output Voltage	V _{OM}	25°C	±12	±14	-	V	R _L ≥ 10kΩ
		25°C	±10	±13	-		R _L ≥ 2kΩ
Large Signal Voltage Gain	A _V	25°C	86	100	-	dB	R _L ≥ 2kΩ, V _{OUT} =±10V V _{ICM} =0V
Input Common-mode Voltage Range	V _{ICM}	25°C	±12	±14	-	V	-
Common-mode Rejection Ratio	CMRR	25°C	70	90	-	dB	V _{ICM} =-12V~+12V
Power Supply Rejection Ratio	PSRR	25°C	76.3	90	-	dB	R _L ≤ 10kΩ
Slew Rate	SR	25°C	-	4	-	V/μs	A _V =0dB, R _L =2kΩ C _L =100pF
Unity Gain Frequency	f _T	25°C	-	4	-	MHz	R _L =2kΩ
Gain Band Width	GBW	25°C	-	10	-	MHz	f=10kHz
Total Harmonic Distortion+Noise	THD+N	25°C	-	0.003	-	%	A _V =20dB, R _L =2kΩ V _{IN} =0.05V _{rms} , f=1kHz
Input Referred Noise Voltage	V _N	25°C	-	8	-	nV/√Hz	R _S =100Ω, V _I =0V f=1kHz
			-	-	2.2	μV _{rms}	R _S =2.2Ω, RIAA BW=10kHz to 30kHz

(Note 9) Absolute value

(Note 10) Current direction: Since first input stage is composed with PNP transistor, input bias current flows out of IC.

OBA4560Rxxx (Unless otherwise specified VCC=+15V, VEE=-15V, Full range -40°C to +105°C)

Parameter	Symbol	Temperature Range	Limits			Unit	Condition
			Min	Typ	Max		
Input Offset Voltage ^(Note 11)	V _{IO}	25°C	-	0.5	6	mV	V _{OUT} =0V
		Full range	-	-	7		
Input Offset Current ^(Note 11)	I _{IO}	25°C	-	5	200	nA	V _{OUT} =0V
		Full range	-	-	200		
Input Bias Current ^(Note 12)	I _B	25°C	-	50	500	nA	V _{OUT} =0V
		Full range	-	-	800		
Supply Current	I _{CC}	25°C	-	3	7	mA	R _L =∞, All Op-Amps V _{IN} +0V
		Full range	-	-	7.5		
Maximum Output Voltage	V _{OM}	25°C	±12	±14	-	V	R _L ≥ 2kΩ
		Full range	±10	±11.5	-		I _O =25mA
Large Signal Voltage Gain	A _V	25°C	86	100	-	dB	R _L ≥ 2kΩ, V _{OUT} =±10V V _{ICM} =0V
		Full range	83	-	-		
Input Common-mode Voltage Range	V _{ICM}	25°C	±12	±14	-	V	-
		Full range	±12	-	-		
Common-mode Rejection Ratio	CMRR	25°C	70	90	-	dB	V _{ICM} =-12V~+12V
Power Supply Rejection Ratio	PSRR	25°C	76.5	90	-	dB	R _L ≤ 10kΩ
Channel Separation	CS	25°C	-	105	-	dB	R ₁ =100Ω, f=1kHz
Slew Rate	SR	25°C	-	4	-	V/μs	A _V =0dB, R _L =2kΩ C _L =100pF
Unity Gain Frequency	f _T	25°C	-	4	-	MHz	R _L =2kΩ
Total Harmonic Distortion+Noise	THD+N	25°C	-	0.003	-	%	A _V =20dB, R _L =2kΩ V _{IN} =0.05V _{rms} , f=1kHz
Input Referred Noise Voltage	V _N	25°C	-	8	-	nV/√Hz	R _S =100Ω, V _I =0V f=1kHz
			-	1.0	-	μV _{rms}	DIN-AUDIO

(Note 11) Absolute value

(Note 12) Current direction: Since first input stage is composed with PNP transistor, input bias current flows out of IC.

OBA4564RFV (Unless otherwise specified VCC=+15V, VEE=-15V, Full range -40°C to +105°C)

Parameter	Symbol	Temperature Range	Limits			Unit	Condition
			Min	Typ	Max		
Input Offset Voltage ^(Note 13)	V _{IO}	25°C	-	0.5	6	mV	V _{OUT} =0V
		Full range	-	-	7		
Input Offset Current ^(Note 13)	I _{IO}	25°C	-	5	200	nA	V _{OUT} =0V
		Full range	-	-	200		
Input Bias Current ^(Note 14)	I _B	25°C	-	50	500	nA	V _{OUT} =0V
		Full range	-	-	800		
Supply Current	I _{CC}	25°C	-	6	14	mA	R _L =∞, All Op-Amps V _{IN+} =0V
		Full range	-	-	15		
Maximum Output Voltage	V _{OM}	25°C	±12	±14	-	V	R _L ≥ 2kΩ
		Full range	±10	±11.5	-		I _O =25mA
Large Signal Voltage Gain	A _V	25°C	86	100	-	dB	R _L ≥ 2kΩ, V _{OUT} =±10V V _{ICM} =0V
		Full range	83	-	-		
Input Common-mode Voltage Range	V _{ICM}	25°C	±12	±14	-	V	-
		Full range	±12	-	-		
Common-mode Rejection Ratio	CMRR	25°C	70	90	-	dB	V _{ICM} =-12V~+12V
Power Supply Rejection Ratio	PSRR	25°C	76.5	90	-	dB	R _L ≤ 10kΩ
Channel Separation	CS	25°C	-	105	-	dB	R ₁ =100Ω, f=1kHz
Slew Rate	SR	25°C	-	4	-	V/μs	A _V =0dB, R _L =2kΩ C _L =100pF
Unity Gain Frequency	f _T	25°C	-	4	-	MHz	R _L =2kΩ
Total Harmonic Distortion+Noise	THD+N	25°C	-	0.003	-	%	A _V =20dB, R _L =2kΩ V _{IN} =0.05V _{rms} , f=1kHz
Input Referred Noise Voltage	V _N	25°C	-	8	-	nV/√Hz	R _S =100Ω, V _I =0V f=1kHz
			-	1.0	-	μV _{rms}	DIN-AUDIO

(Note 13) Absolute value

(Note 14) Current direction: Since first input stage is composed with PNP transistor, input bias current flows out of IC.

OBA4564WFV (Unless otherwise specified VCC=+15V, VEE=-15V, Full range -40°C to +105°C)

Parameter	Symbol	Temperature Range	Limits			Unit	Condition
			BA4564WFV				
			Min	Typ	Max		
Input Offset Voltage ^(Note 15)	V _{IO}	25°C	-	0.5	2.5	mV	V _{OUT} =0V
		Full range	-	-	4		
Input Offset Current ^(Note 15)	I _{IO}	25°C	-	5	200	nA	V _{OUT} =0V
		Full range	-	-	200		
Input Bias Current ^(Note 16)	I _B	25°C	-	50	300	nA	V _{OUT} =0V
		Full range	-	-	500		
Supply Current	I _{CC}	25°C	-	6	11	mA	R _L =∞, All Op-Amps V _{IN} =0V
		Full range	-	-	13		
Maximum Output Voltage	V _{OM}	25°C	±12	±14	-	V	R _L ≥ 2kΩ I _o =25mA
		Full range	±10	±11.5	-		
Large Signal Voltage Gain	A _V	25°C	86	100	-	dB	R _L ≥ 2kΩ, V _{OUT} =±10V V _{ICM} =0V
		Full range	83	-	-		
Input Common-mode Voltage Range	V _{ICM}	25°C	±12	±14	-	V	-
		Full range	±12	-	-		
Common-mode Rejection Ratio	CMRR	25°C	70	90	-	dB	V _{ICM} =-12V~+12V
Power Supply Rejection Ratio	PSRR	25°C	76.5	90	-	dB	R _i ≤ 10kΩ
Channel Separation	CS	25°C	-	105	-	dB	R ₁ =100Ω, f=1kHz
Slew Rate	SR	25°C	-	4	-	V/μs	A _V =0dB, R _L =2kΩ C _L =100pF
Unity Gain Frequency	f _T	25°C	-	4	-	MHz	R _L =2kΩ
Total Harmonic Distortion+Noise	THD+N	25°C	-	0.003	-	%	A _V =20dB, R _L =2kΩ V _{IN} =0.05V _{rms} , f=1kHz
Input Referred Noise Voltage	V _N	25°C	-	8	-	nV/√Hz	R _S =100Ω, V _i =0V f=1kHz
			-	1.0	-	μV _{rms}	DIN-AUDIO

(Note 15) Absolute value

(Note 16) Current direction: Since first input stage is composed with PNP transistor, input bias current flows out of IC.

Description of electrical characteristics

Described here are the terms of electric characteristics used in this datasheet. Items and symbols used are also shown. Note that item name and symbol and their meaning may differ from those on another manufacture's document or general document.

1. Absolute maximum ratings

Absolute maximum rating item indicates the condition which must not be exceeded. Application of voltage in excess of absolute maximum rating or use out of absolute maximum rated temperature environment may cause deterioration of characteristics.

1.1 Power supply voltage (VCC-VEE)

Indicates the maximum voltage that can be applied between the positive power supply terminal and negative power supply terminal without deterioration or destruction of characteristics of internal circuit.

1.2 Differential input voltage (V_{ID})

Indicates the maximum voltage that can be applied between non-inverting terminal and inverting terminal without deterioration and destruction of characteristics of IC.

1.3 Input common-mode voltage range (V_{ICM})

Indicates the maximum voltage that can be applied to non-inverting terminal and inverting terminal without deterioration or destruction of characteristics. Input common-mode voltage range of the maximum ratings not assure normal operation of IC. When normal operation of IC is desired, the input common-mode voltage of characteristics item must be followed.

1.4 Power dissipation (P_D)

Indicates the power that can be consumed by specified mounted board at the ambient temperature 25°C(normal temperature). As for package product, P_D is determined by the temperature that can be permitted by IC chip in the package (maximum junction temperature)and thermal resistance of the package.

2. Electrical characteristics item**2.1 Input offset voltage (V_{IO})**

Indicates the voltage difference between non-inverting terminal and inverting terminal. It can be translated into the input voltage difference required for setting the output voltage at 0 V .

2.2 Input offset current (I_{IO})

Indicates the difference of input bias current between non-inverting terminal and inverting terminal.

2.3 Input bias current (I_B)

Indicates the current that flows into or out of the input terminal. It is defined by the average of input bias current at non-inverting terminal and input bias current at inverting terminal.

2.4 Input common-mode voltage range(V_{ICM})

Indicates the input voltage range where IC operates normally.

2.5 Large signal voltage gain (A_V)

Indicates the amplifying rate (gain) of output voltage against the voltage difference between non-inverting terminal and Inverting terminal. It is normally the amplifying rate (gain) with reference to DC voltage.
 $A_V = (\text{Output voltage fluctuation}) / (\text{Input offset fluctuation})$

2.6 Circuit current (I_{CC})

Indicates the IC current that flows under specified conditions and no-load steady status.

2.7 Output saturation voltage (V_{OM})

Signifies the voltage range that can be output under specific output conditions.

2.8 Common-mode rejection ratio (CMRR)

Indicates the ratio of fluctuation of input offset voltage when in-phase input voltage is changed. It is normally the fluctuation of DC.

$$\text{CMRR} = (\text{Change of Input common-mode voltage}) / (\text{Input offset fluctuation})$$

2.9 Power supply rejection ratio (PSRR)

Indicates the ratio of fluctuation of input offset voltage when supply voltage is changed. It is normally the fluctuation of DC.

$$\text{PSRR} = (\text{Change of power supply voltage}) / (\text{Input offset fluctuation})$$

2.10 Unity gain frequency (ft)

Indicates a frequency where the voltage gain of operational amplifier is 1.

2.11 Slew Rate (SR)

SR is a parameter that shows movement speed of operational amplifier. It indicates rate of variable output voltage as unit time.

2.12 Gain Band Width (GBW)

Indicates to multiply by the frequency and the gain where the voltage gain decreases 6dB/octave.

2.13 Total harmonic distortion + Noise (THD+N)

Indicates the fluctuation of input offset voltage or that of output voltage with reference to the change of output voltage of driven channel.

2.14 Input referred noise voltage (V_N)

Indicates a noise voltage generated inside the operational amplifier equivalent by ideal voltage source connected in series with input terminal.

Typical Performance Curves

OBA4560xxx

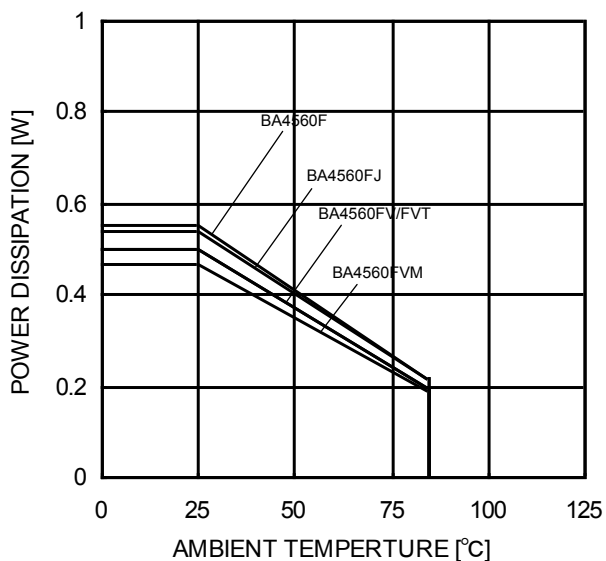

Figure 2.
Derating Curve

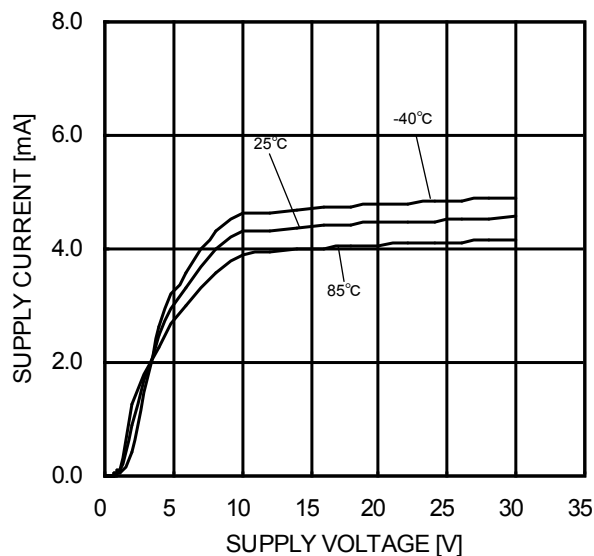

Figure 3.
Supply Current - Supply Voltage

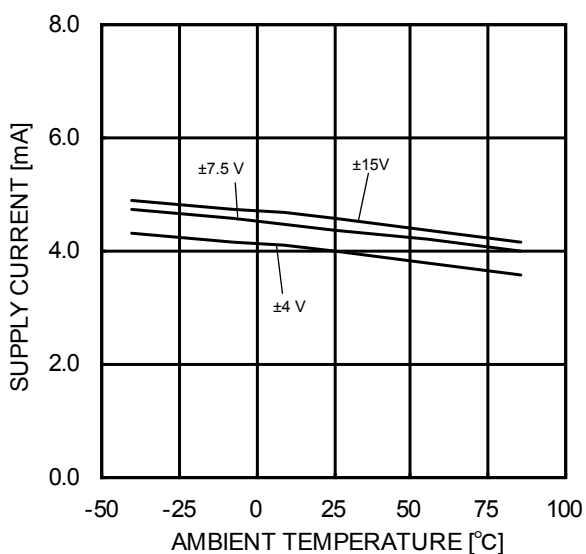

Figure 4.
Supply Current - Ambient Temperature

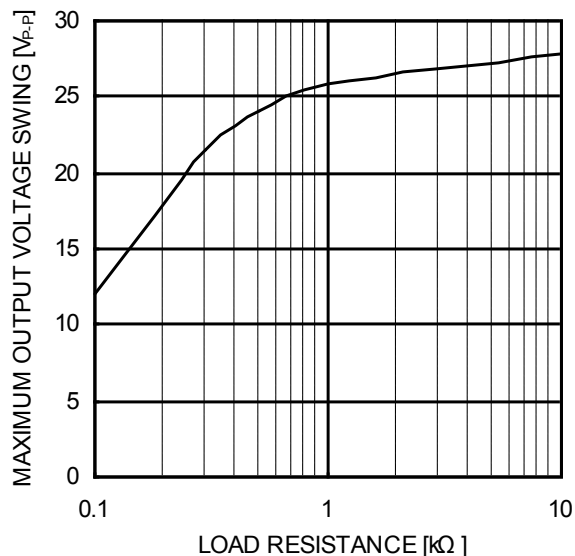

Figure 5.
Maximum Output Voltage Swing
- Load Resistance
(VCC/VEE=+15V/-15V, T_A=25°C)

(*)The above data is measurement value of typical sample, it is not guaranteed.

OBA4560xxx

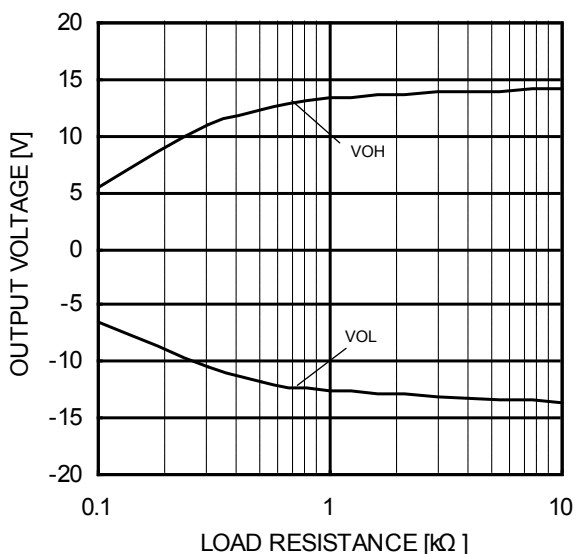

Figure 6.
Maximum Output Voltage
- Load Resistance
(VCC/VEE=+15V/-15V, T_A =25°C)

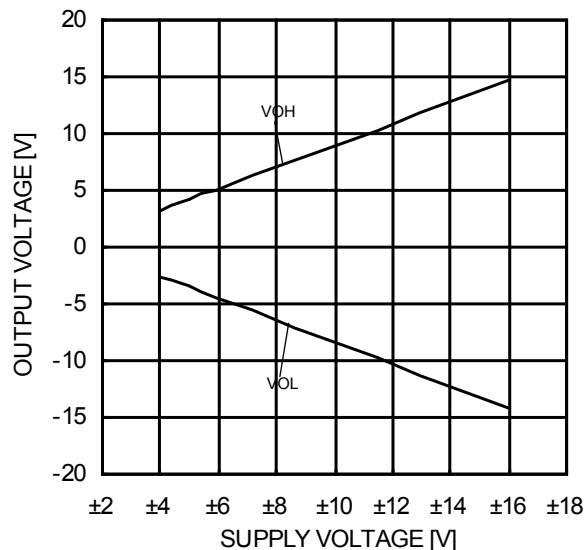

Figure 7.
Maximum Output Voltage
- Supply Voltage
(R_L=2kΩ, T_A =25°C)

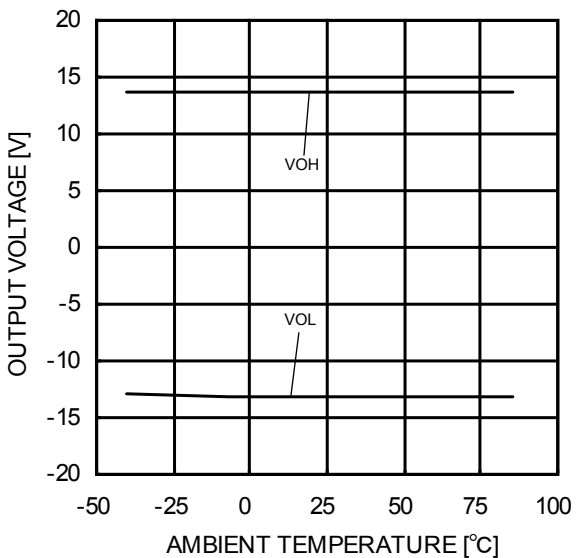

Figure 8.
Maximum Output Voltage
- Ambient Temperature
(VCC/VEE=+15V/-15V, R_L=2kΩ)

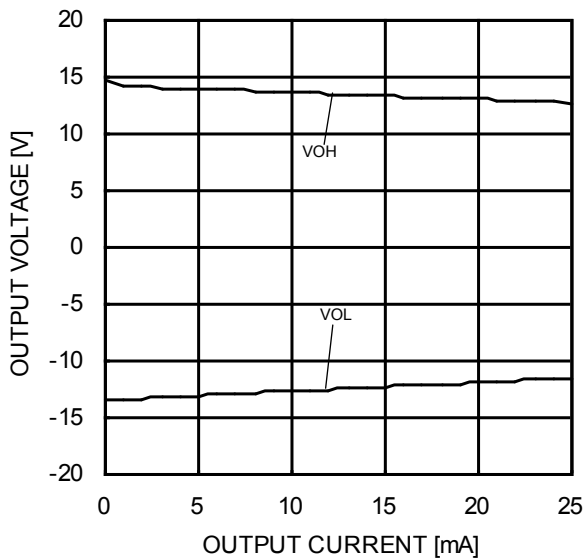

Figure 9.
Maximum Output Voltage
- Output Current
(VCC/VEE=+15V/-15V, T_A =25°C)

(*)The above data is measurement value of typical sample, it is not guaranteed.

OBA4560xxx

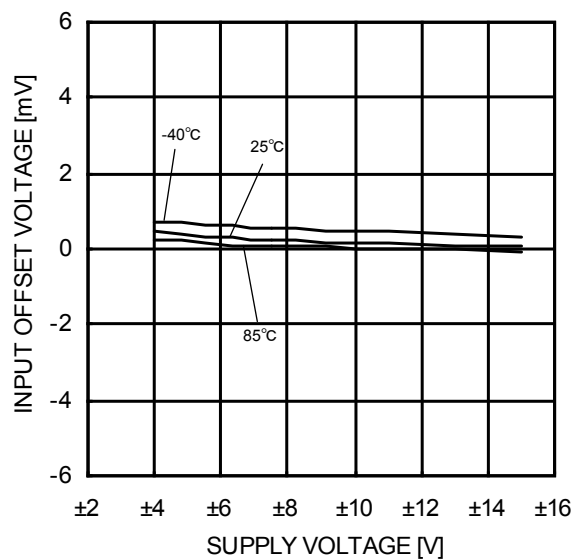

Figure 10.
Input Offset Voltage - Supply Voltage
($V_{ICM}=0V, V_{OUT}=0V$)

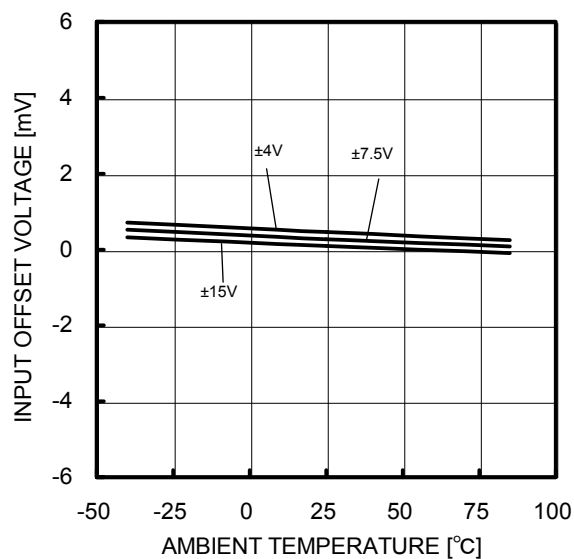

Figure 11.
Input Offset Voltage - Ambient Temperature
($V_{ICM}=0V, V_{OUT}=0V$)

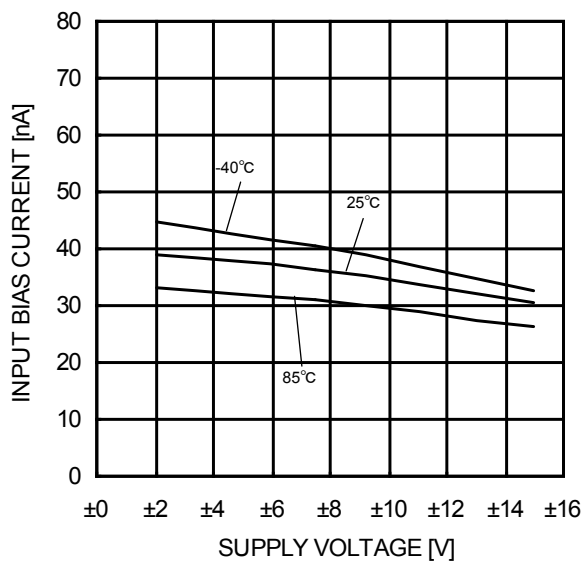

Figure 12.
Input Bias Current - Supply Voltage
($V_{ICM}=0V, V_{OUT}=0V$)

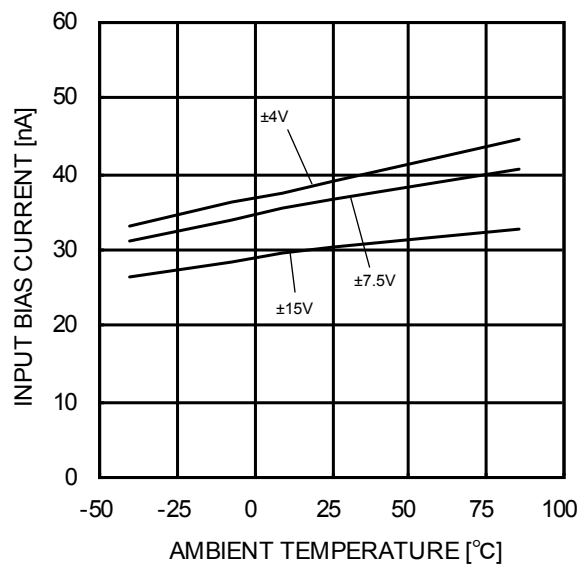

Figure 13.
Input Bias Current - Ambient Temperature
($V_{ICM}=0V, V_{OUT}=0V$)

(*The above data is measurement value of typical sample, it is not guaranteed.

OBA4560xxx

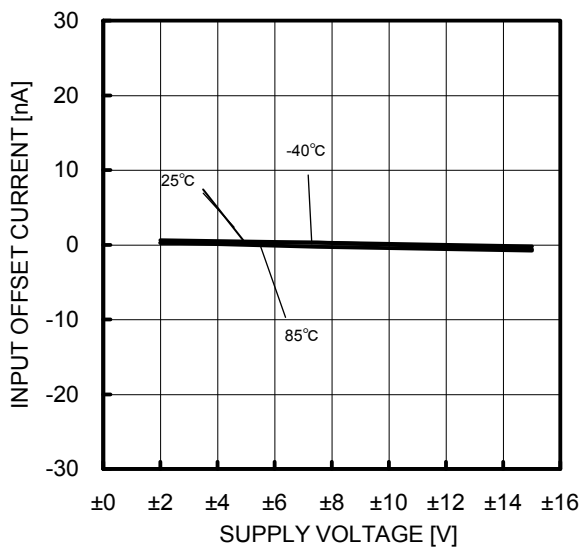

Figure 14.
Input Offset Current - Supply Voltage
($V_{ICM}=0V$, $V_{OUT}=0V$)

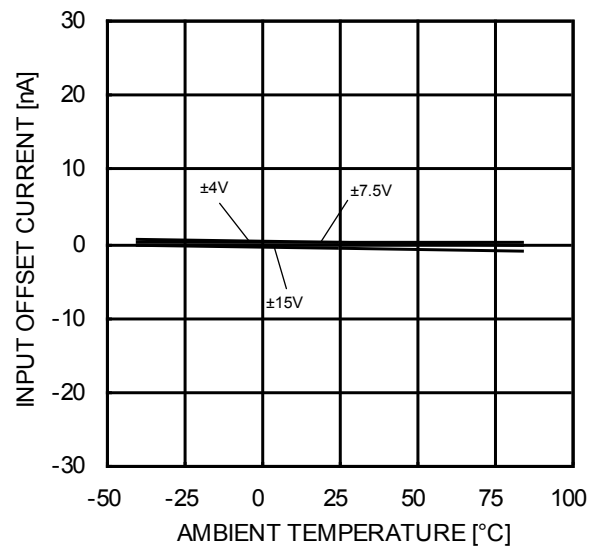

Figure 15.
Input Offset Current - Ambient Temperature
($V_{ICM}=0V$, $V_{OUT}=0V$)

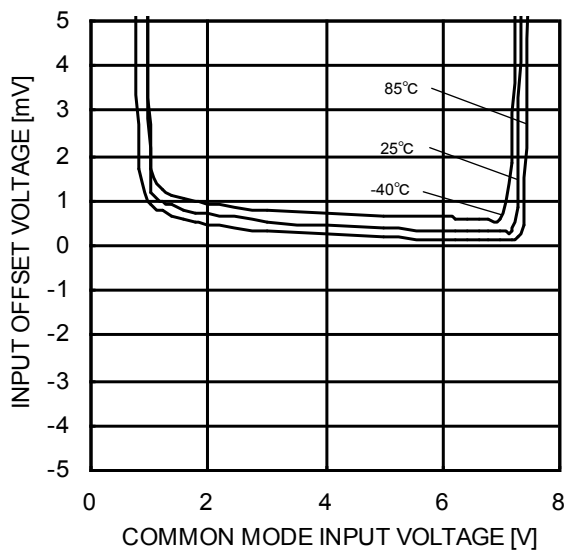

Figure 16.
Input Offset Voltage
-Common Mode Input Voltage
($V_{CC}=8V$, $V_{OUT}=4V$)

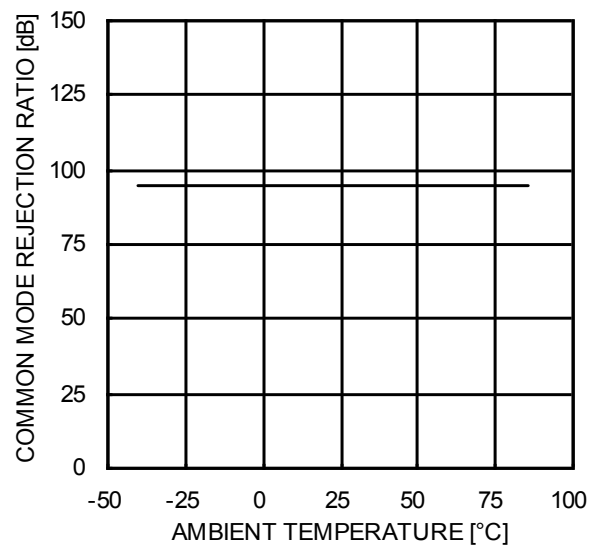

Figure 17.
Common Mode Rejection Ratio
- Ambient Temperature
($V_{CC}/V_{EE}=+15V/-15V$, $V_{ICM}=-12V$ to $+12V$)

(*The above data is measurement value of typical sample, it is not guaranteed.

OBA4560xxx

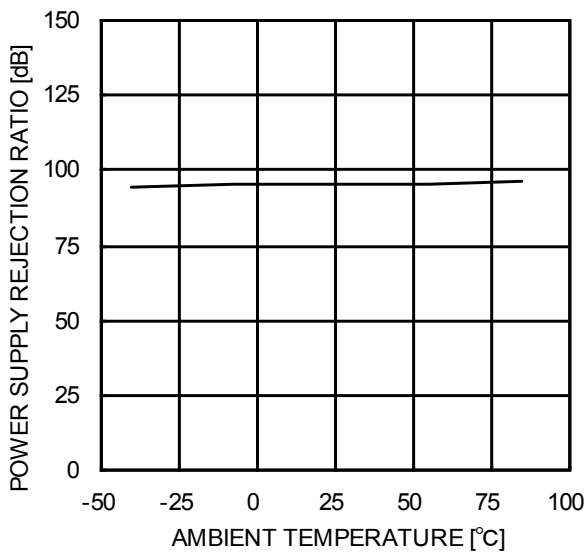

Figure 18.
Power Supply Rejection Ratio
- Ambient Temperature
(VCC/VEE=+4V/-4V to +15V/-15V)

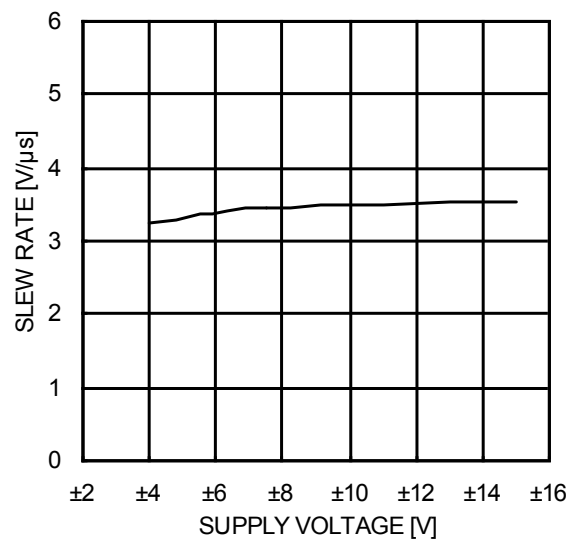

Figure 19.
Slew Rate - Supply Voltage
(C_L=100pF, R_L=2kΩ, T_A =25°C)

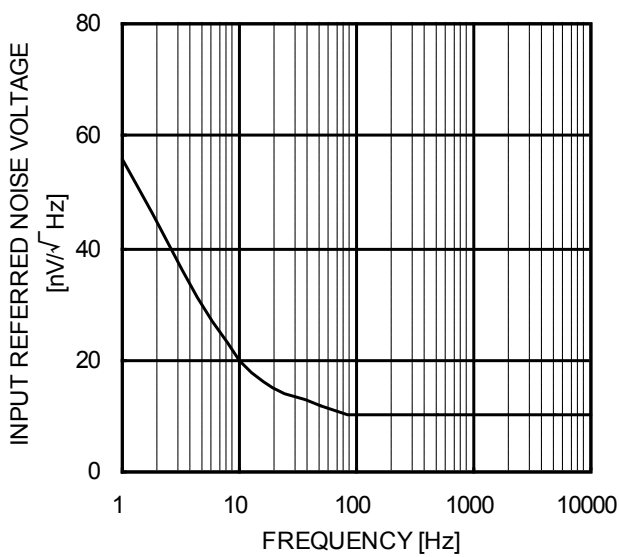

Figure 20.
Equivalent Input Noise Voltage - Frequency
(VCC/VEE=+15V/-15V, R_S=100Ω, T_A =25°C)

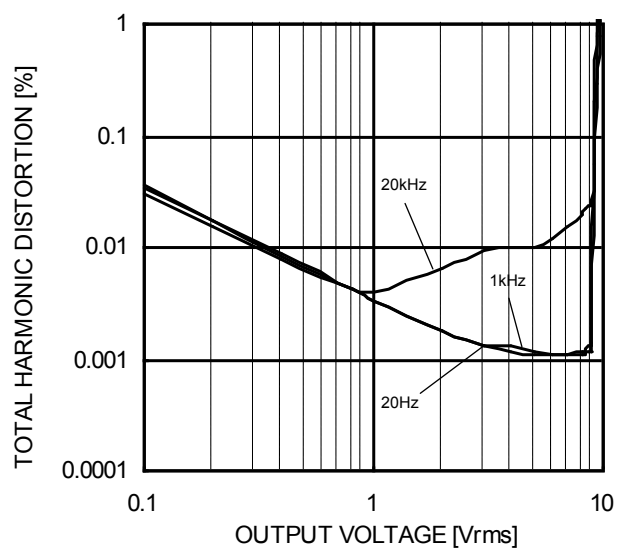

Figure 21.
Total Harmonic Distortion - Output Voltage
(VCC/VEE=+15V/-15V, A_v=20dB, R_L=2kΩ, 80kHz-LPF, T_A =25°C)

(*The above data is measurement value of typical sample, it is not guaranteed.

OBA4560xxx

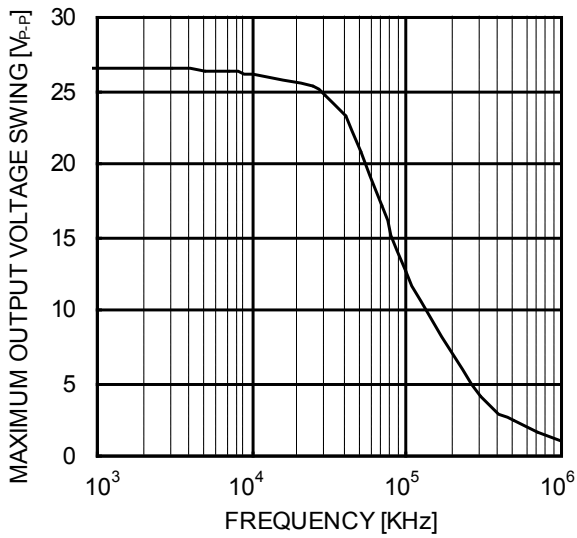

Figure 22.
Maximum Output Voltage Swing – Frequency
(VCC/VEE=+15V/-15V, R_L=2kΩ, T_A =25°C)

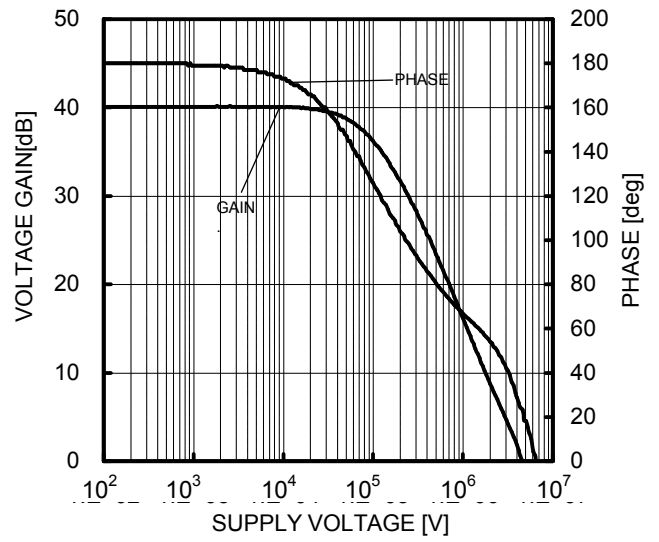

Figure 23.
Voltage Gain - Frequency
(VCC/VEE=+15V/-15V, A_v=40dB, R_L=2kΩ, T_A =25°C)

(*The above data is measurement value of typical sample, it is not guaranteed.

OBA4560Rxxx

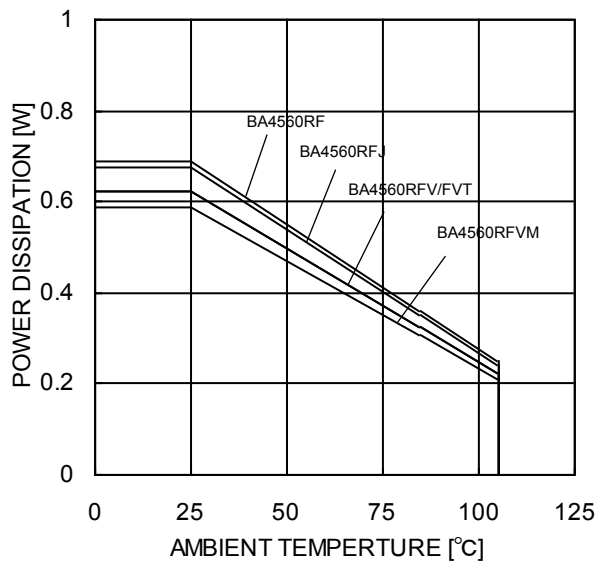

Figure 24. Derating Curve

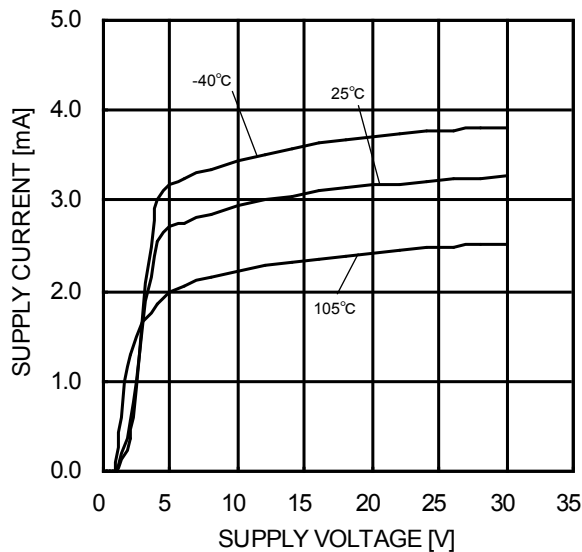

Figure 25. Supply Current - Supply Voltage

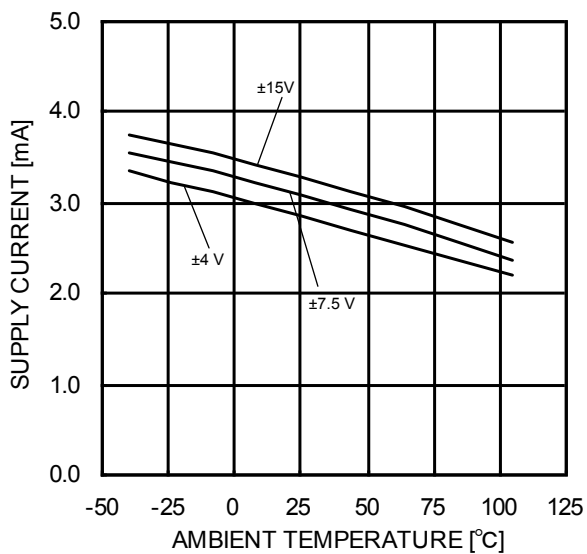

Figure 26. Supply Current - Ambient Temperature

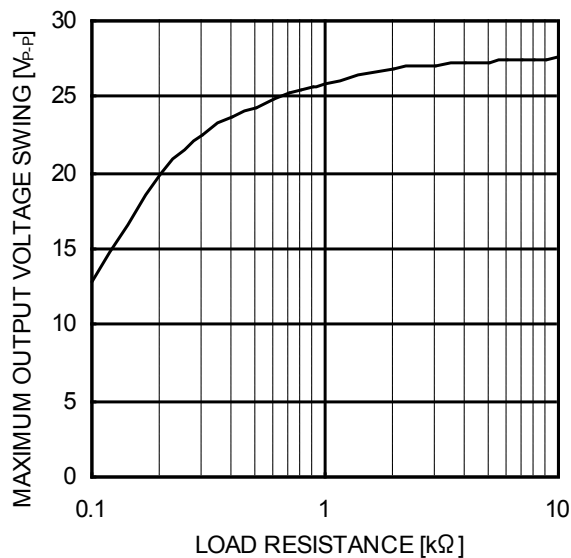

Figure 27. Maximum Output Voltage Swing - Load Resistance (VCC/VEE=+15V/-15V, T_A =25°C)

(*)The above data is measurement value of typical sample, it is not guaranteed.

OBA4560Rxxx

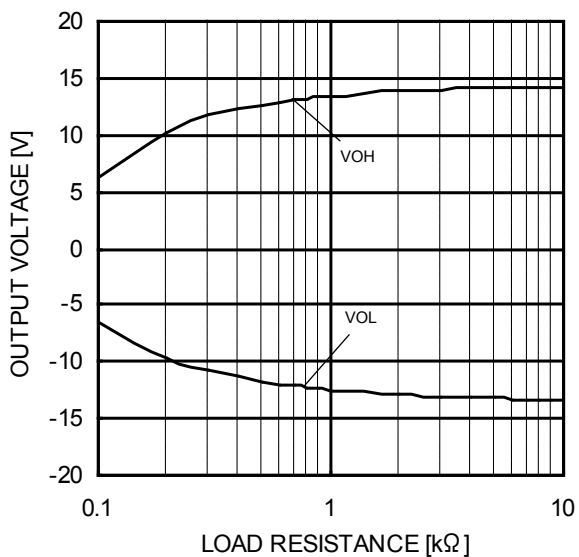

Figure 28.
Maximum Output Voltage
- Load Resistance
(VCC/VEE=+15V/-15V, T_A =25°C)

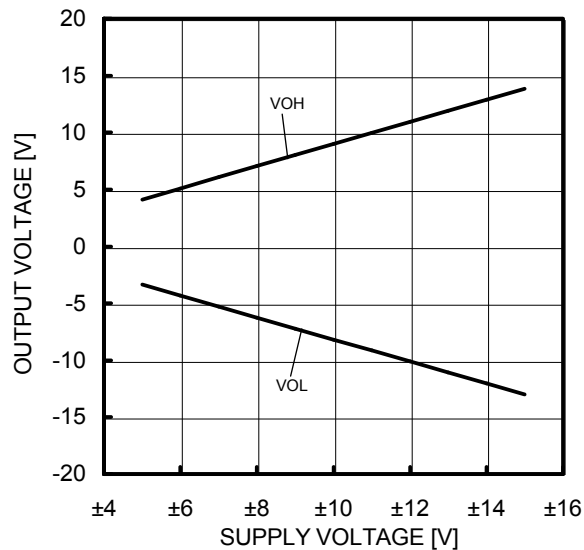

Figure 29.
Maximum Output Voltage
- Supply Voltage
(R_L=2kΩ, T_A =25°C)

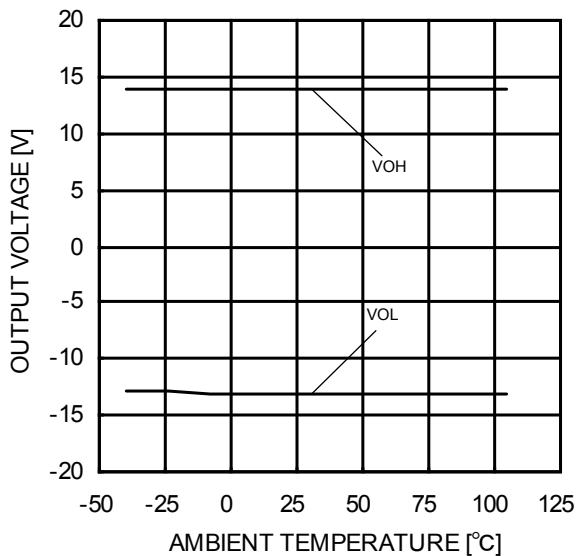

Figure 30.
Maximum Output Voltage
- Ambient Temperature
(VCC/VEE=+15V/-15V, R_L=2kΩ)

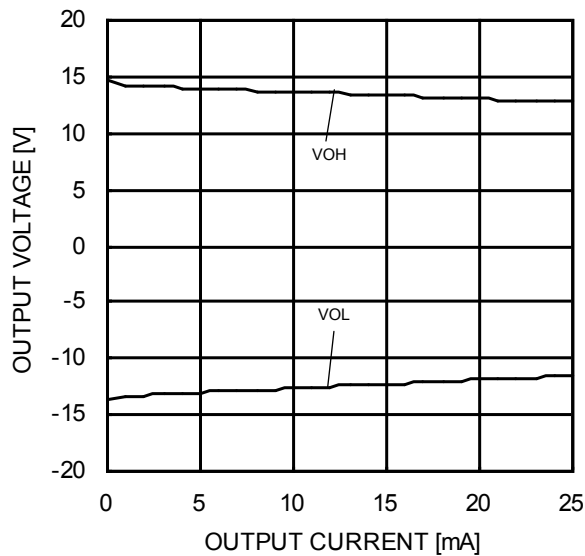

Figure 31.
Maximum Output Voltage
- Output Current
(VCC/VEE=+15V/-15V, T_A =25°C)

(*)The above data is measurement value of typical sample, it is not guaranteed.

OBA4560Rxxx

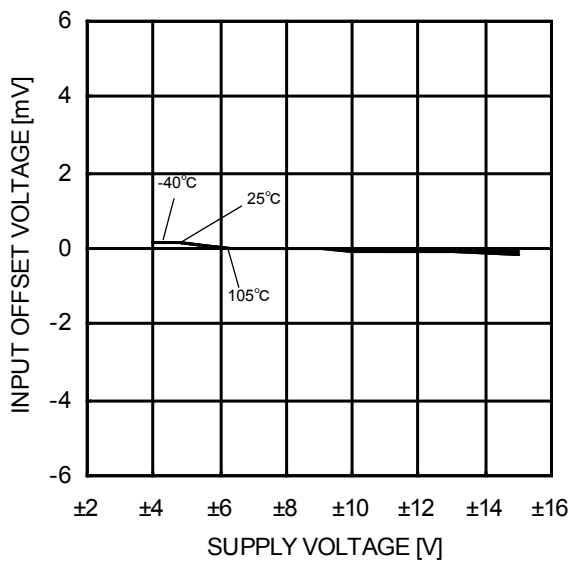

Figure 32.
Input Offset Voltage - Supply Voltage
($V_{ICM}=0V, V_{OUT}=0V$)

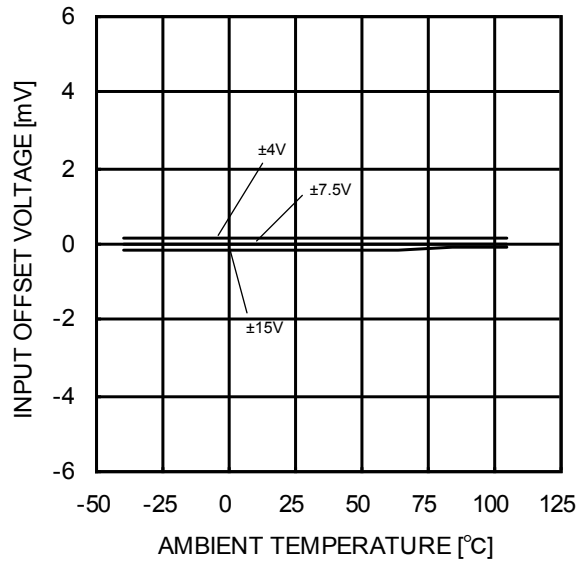

Figure 33.
Input Offset Voltage - Ambient Temperature
($V_{ICM}=0V, V_{OUT}=0V$)

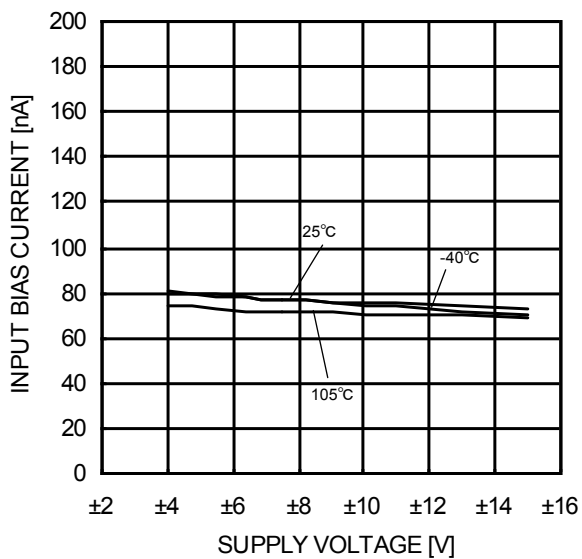

Figure 34.
Input Bias Current - Supply Voltage
($V_{ICM}=0V, V_{OUT}=0V$)

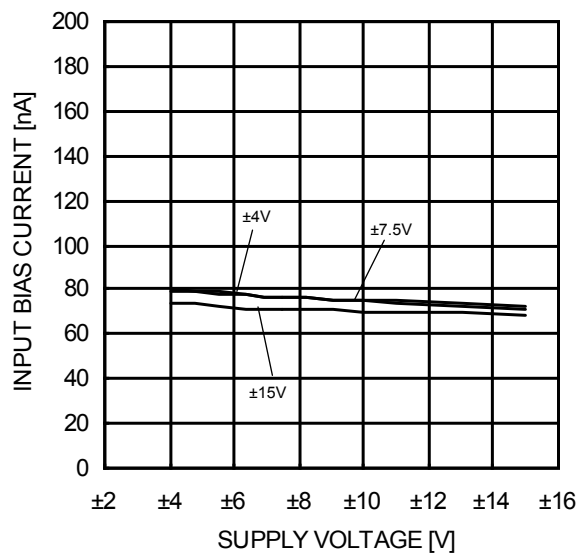

Figure 35.
Input Bias Current - Ambient Temperature
($V_{ICM}=0V, V_{OUT}=0V$)

(*The above data is measurement value of typical sample, it is not guaranteed.

OBA4560Rxxx

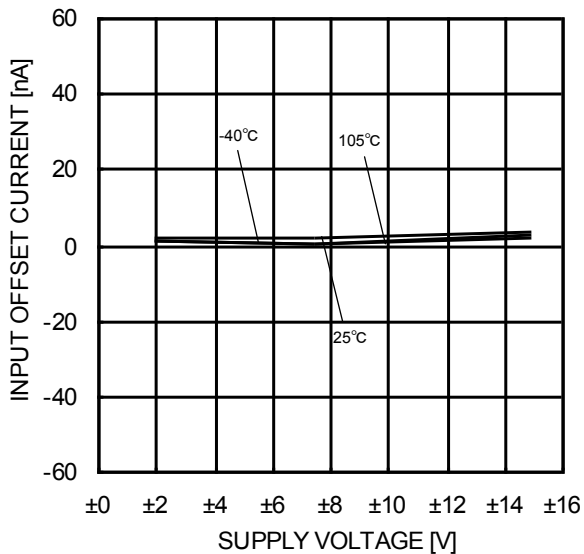

Figure 36.
Input Offset Current - Supply Voltage
($V_{ICM}=0V$, $V_{OUT}=0V$)

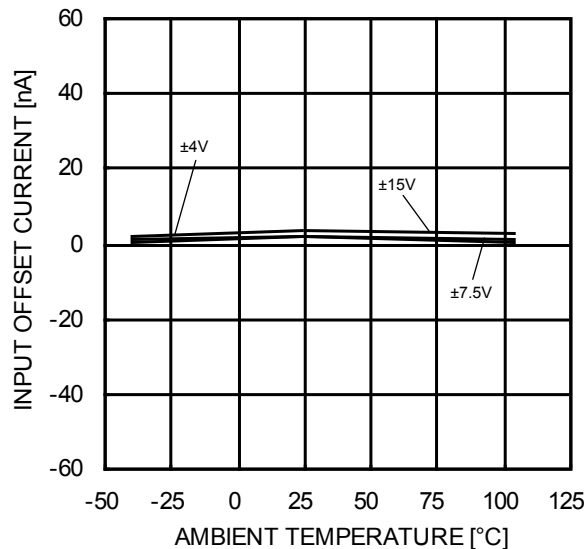

Figure 37.
Input Offset Current - Ambient Temperature
($V_{ICM}=0V$, $V_{OUT}=0V$)

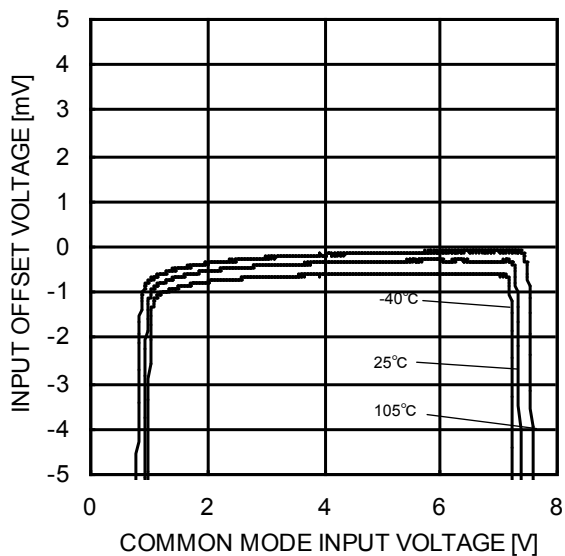

Figure 38.
Input Offset Voltage
-Common Mode Input Voltage
($V_{CC}=8V$, $V_{OUT}=4V$)

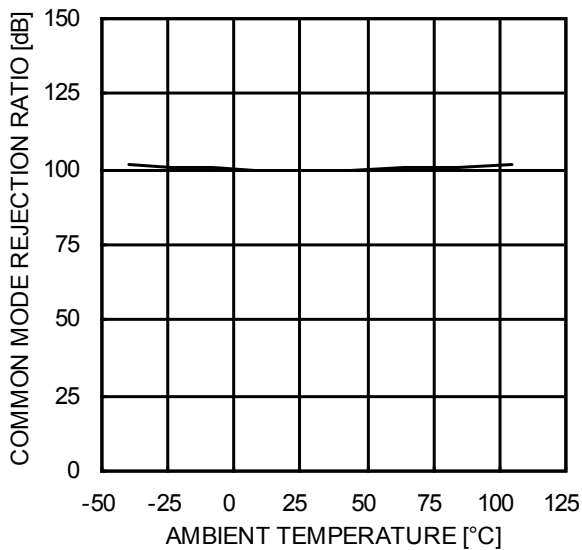

Figure 39.
Common Mode Rejection Ratio
- Ambient Temperature
($V_{CC}/V_{EE}=+15V/-15V$, $V_{ICM}=-12V$ to $+12V$)

(*The above data is measurement value of typical sample, it is not guaranteed.

OBA4560Rxxx

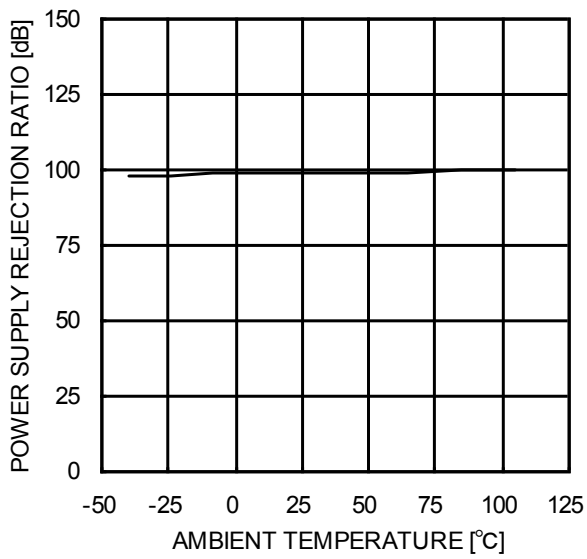

Figure 40.
Power Supply Rejection Ratio
- Ambient Temperature
(VCC/VEE=+4V/-4V to +15V/-15V)

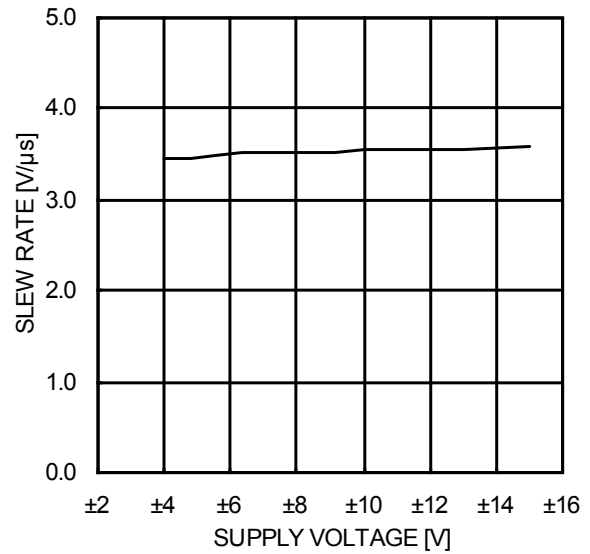

Figure 41.
Slew Rate - Supply Voltage
(C_L=100pF, R_L=2kΩ, T_A=25°C)

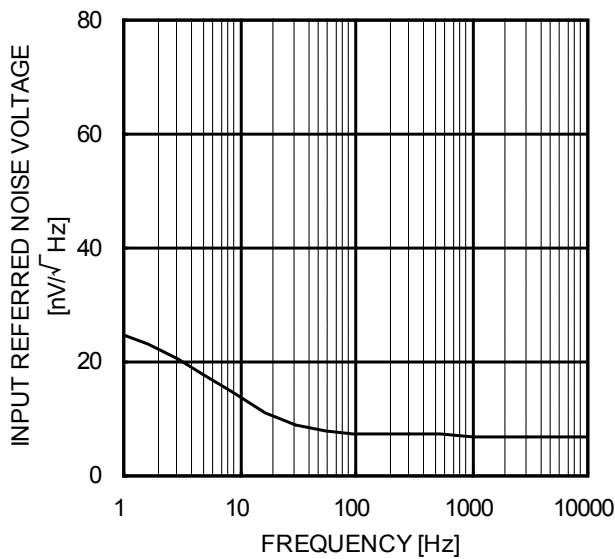

Figure 42.
Equivalent Input Noise Voltage - Frequency
(VCC/VEE=+15V/-15V, R_S=100Ω, T_A=25°C)

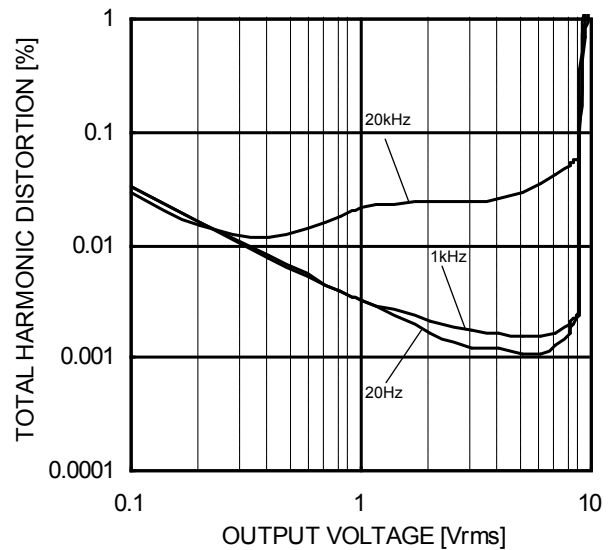

Figure 43.
Total Harmonic Distortion - Output Voltage
(VCC/VEE=+15V/-15V, A_V=20dB, R_L=2kΩ, 80kHz-LPF, T_A=25°C)

(*The above data is measurement value of typical sample, it is not guaranteed.

OBA4560Rxxx

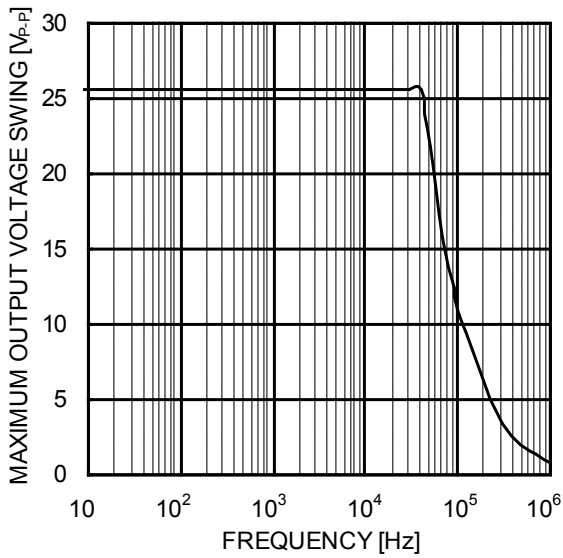

Figure 44.
Maximum Output Voltage Swing - Frequency
(VCC/VEE=+15V/-15V, R_L=2kΩ, T_A =25°C)

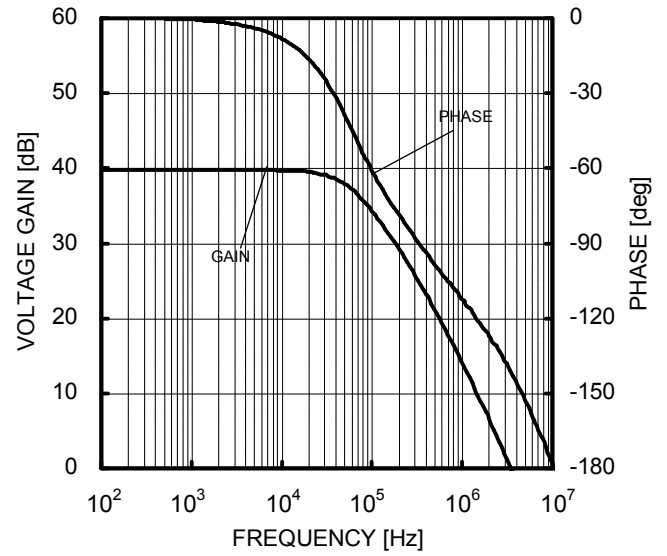

Figure 45.
Voltage Gain - Frequency (VCC/VEE=+15V/-15V,
A_V=40dB, R_L=2kΩ, T_A =25°C)

(*The above data is measurement value of typical sample, it is not guaranteed.

OBA4564RFV

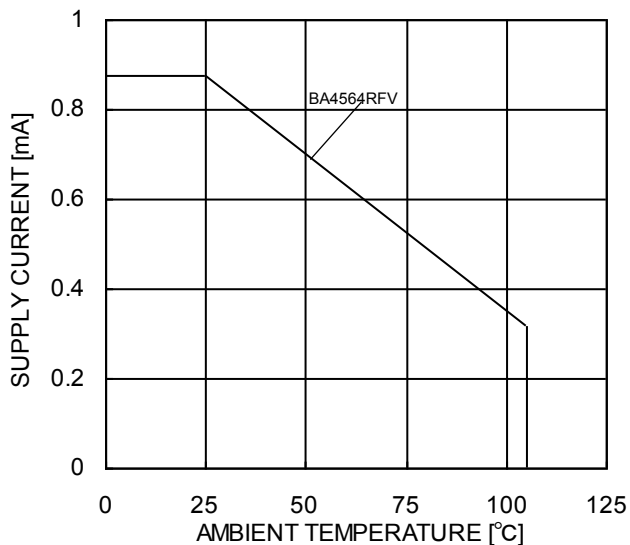

Figure 46.
Derating Curve

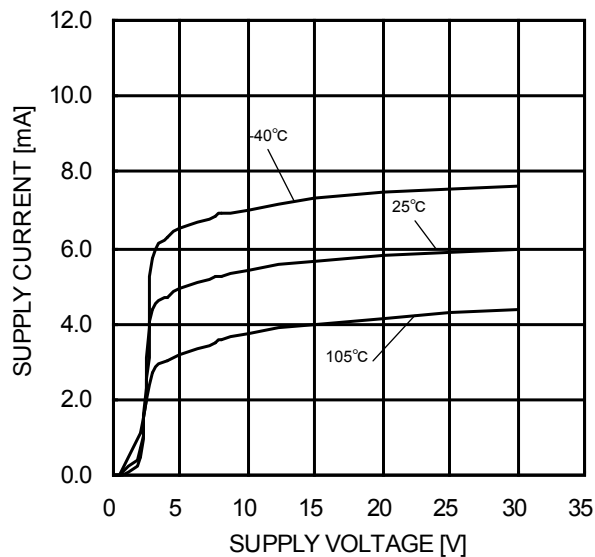

Figure 47.
Supply Current - Supply Voltage

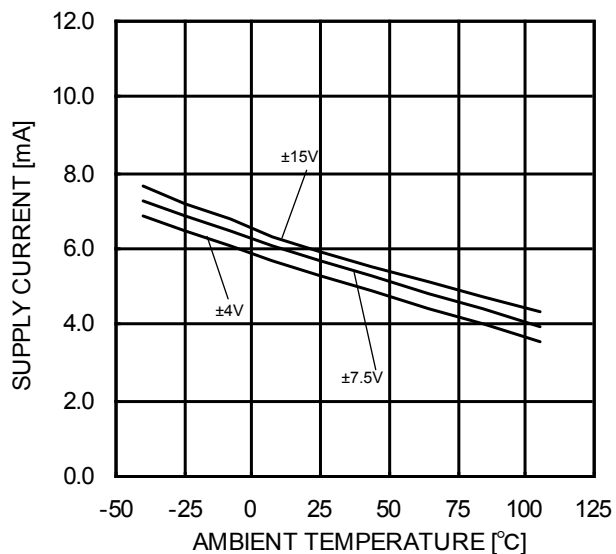

Figure 48.
Supply Current - Ambient Temperature

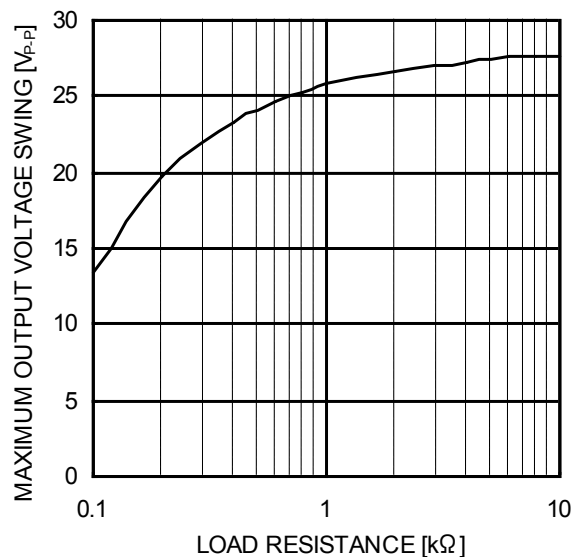

Figure 49.
Maximum Output Voltage Swing
- Load Resistance
(VCC/VEE=+15V/-15V, T_A=25°C)

(*The above data is measurement value of typical sample, it is not guaranteed.

OBA4564RFV

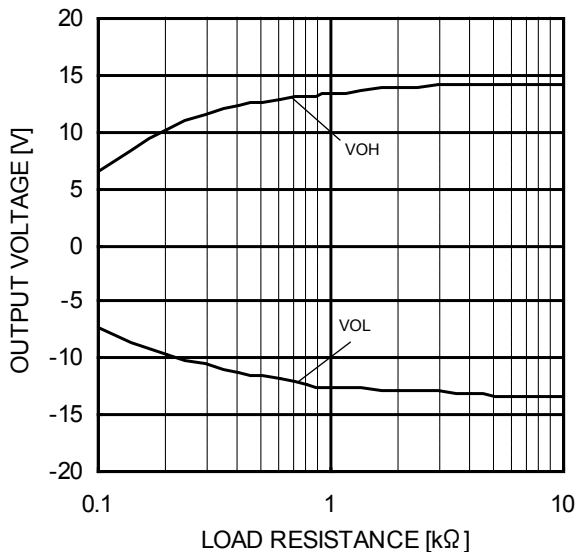

Figure 50.
Maximum Output Voltage
-Load Resistance
(VCC/VEE=+15V/-15V, T_A =25°C)

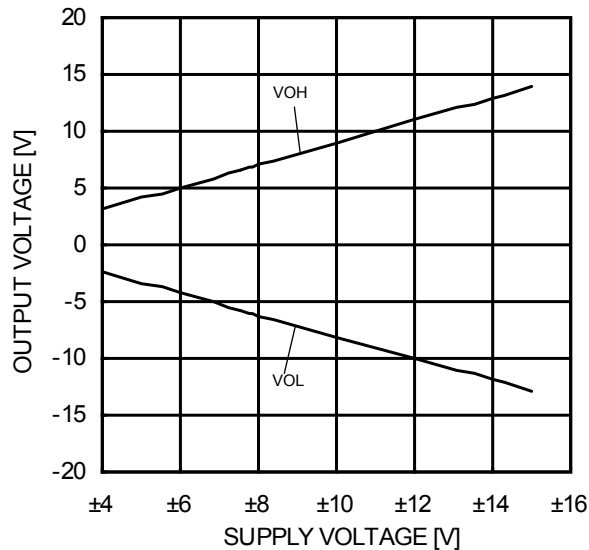

Figure 51.
Maximum Output Voltage
-Supply Voltage
(R_L=2kΩ, T_A =25°C)

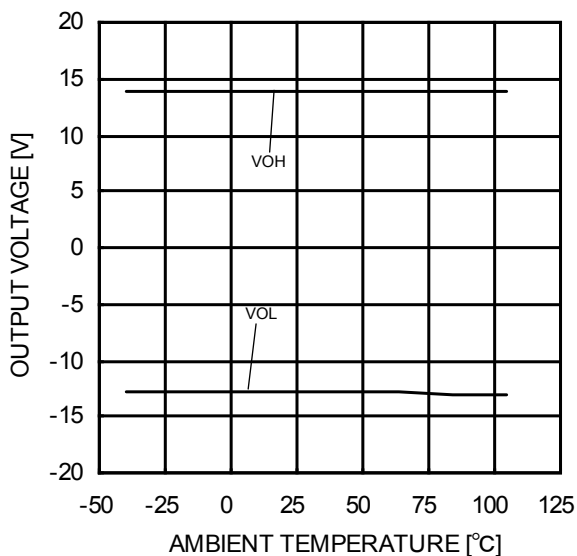

Figure 52.
Maximum Output Voltage
- Ambient Temperature
(VCC/VEE=+15V/-15V, R_L=2kΩ)

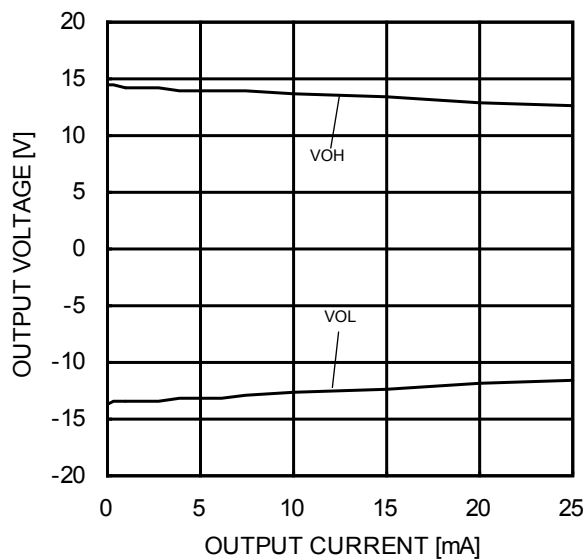

Figure 53.
Maximum Output Voltage
- Output Current
(VCC/VEE=+15V/-15V, T_A =25°C)

(*)The above data is measurement value of typical sample, it is not guaranteed.

OBA4564RFV

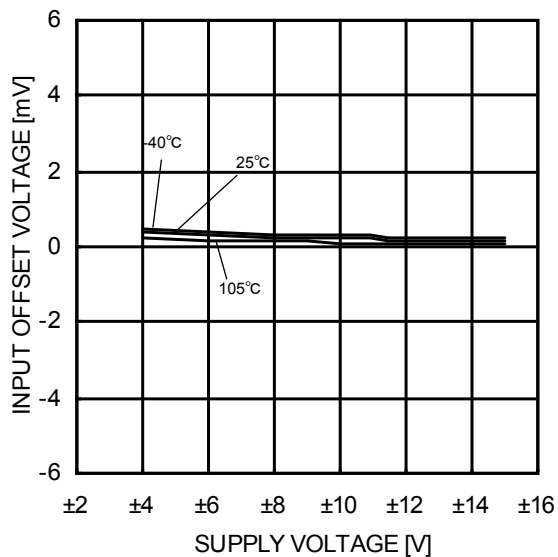

Figure 54.
Input Offset Voltage - Supply Voltage
($V_{ICM}=0V$, $V_{OUT}=0V$)

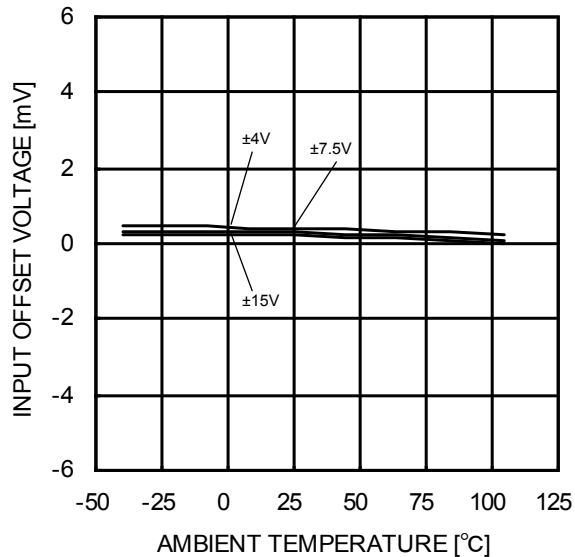

Figure 55.
Input Offset Voltage - Ambient Temperature
($V_{ICM}=0V$, $V_{OUT}=0V$)

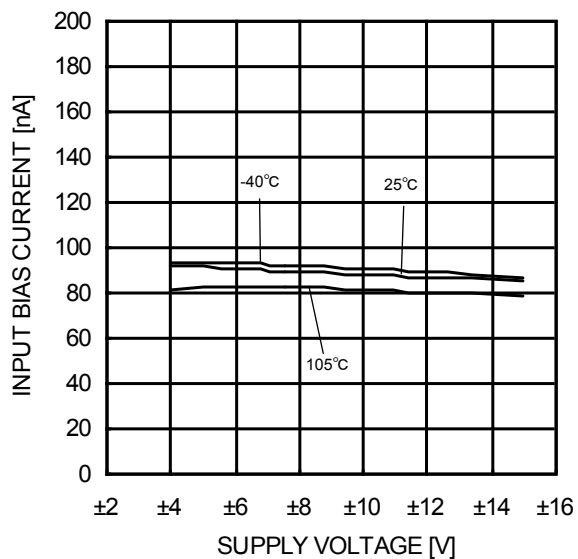

Figure 56.
Input Bias Current - Supply Voltage
($V_{ICM}=0V$, $V_{OUT}=0V$)

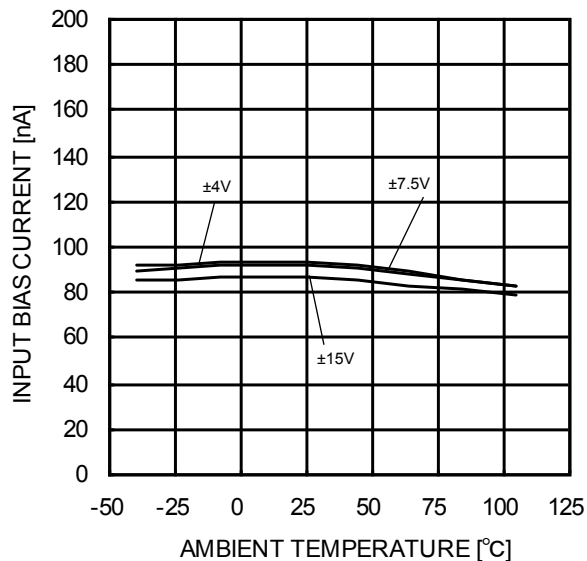

Figure 57.
Input Bias Current - Ambient Temperature
($V_{ICM}=0V$, $V_{OUT}=0V$)

(*The above data is measurement value of typical sample, it is not guaranteed.

OBA4564RFV

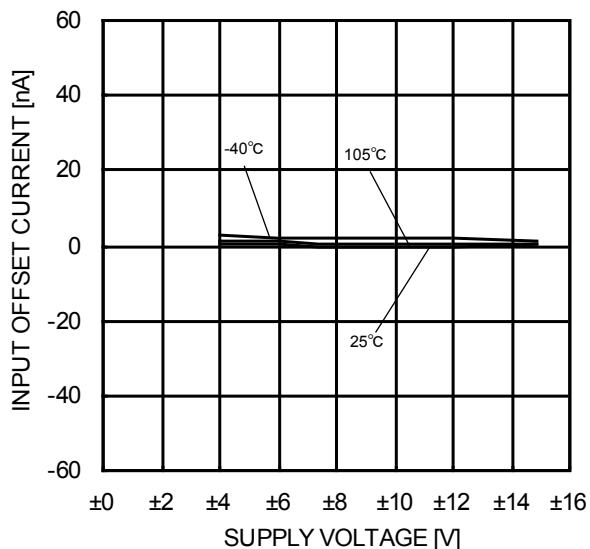

Figure 58.
Input Offset Current - Supply Voltage
($V_{ICM}=0V$, $V_{OUT}=0V$)

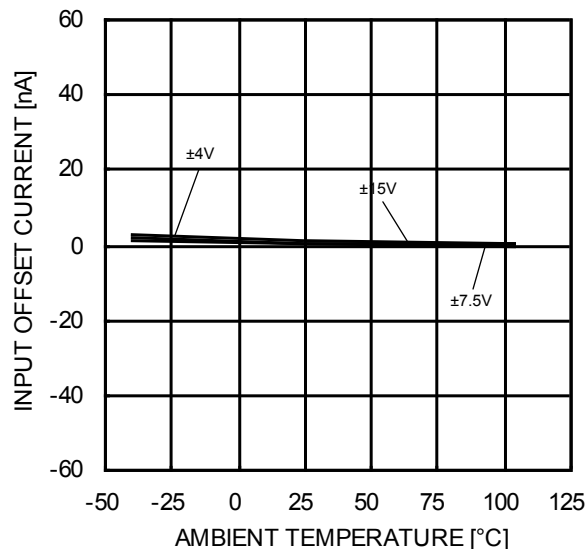

Figure 59.
Input Offset Current - Ambient Temperature
($V_{ICM}=0V$, $V_{OUT}=0V$)

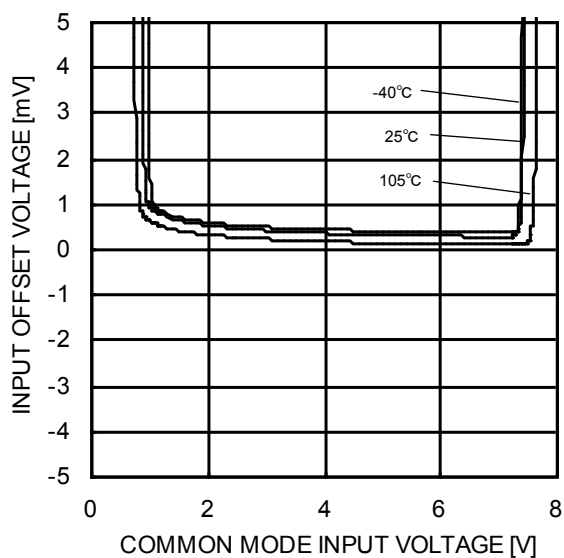

Figure 60.
Input Offset Voltage
- Common Mode Input Voltage
($V_{CC}=8V$, $V_{OUT}=4V$)

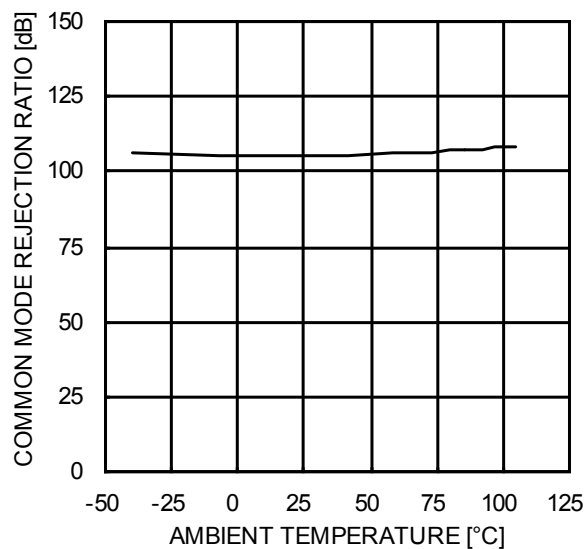

Figure 61.
Common Mode Rejection Ratio
- Ambient Temperature
($V_{CC}/V_{EE}=+15V/-15V$, $V_{ICM}=-12V$ to $+12V$)

(*The above data is measurement value of typical sample, it is not guaranteed.

OBA4564RFV

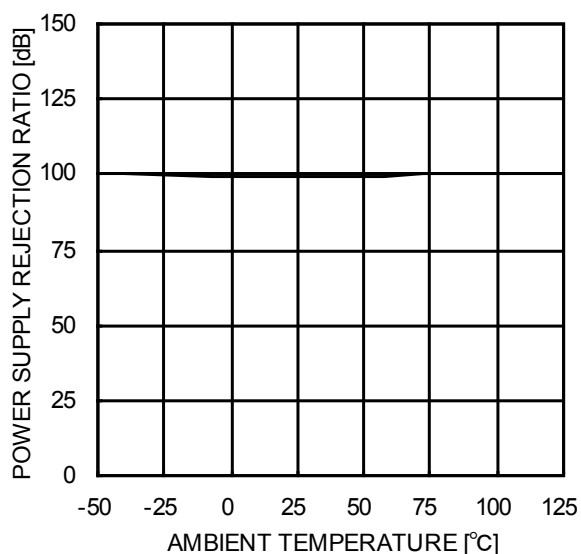

Figure 62.
Power Supply Rejection Ratio
- Ambient Temperature
(VCC/VEE=+4V/-4V to +15V/-15V)

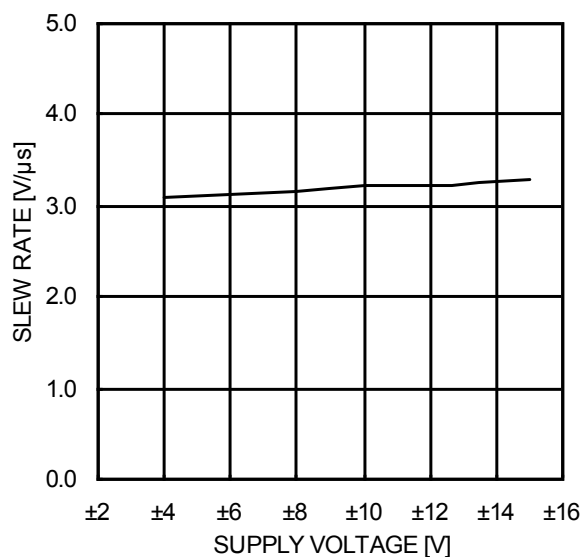

Figure 63.
Slew Rate - Supply Voltage
(C_L=100pF, R_L=2kΩ, T_A=25°C)

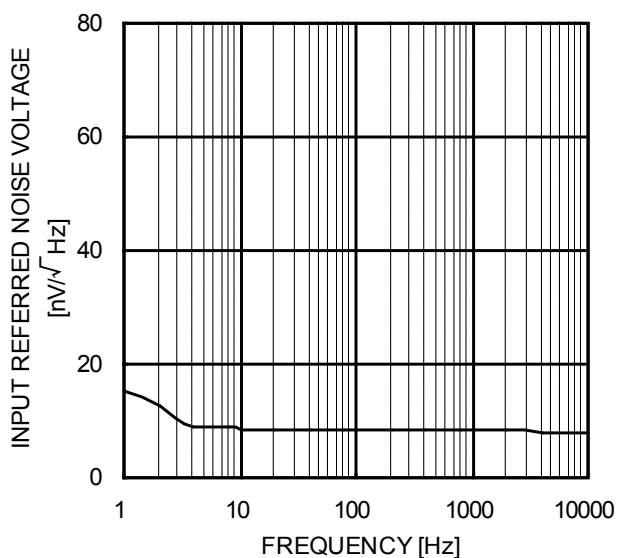

Figure 64.
Equivalent Input Noise Voltage - Frequency
(VCC/VEE=+15V/-15V, R_S=100Ω, T_A=25°C)

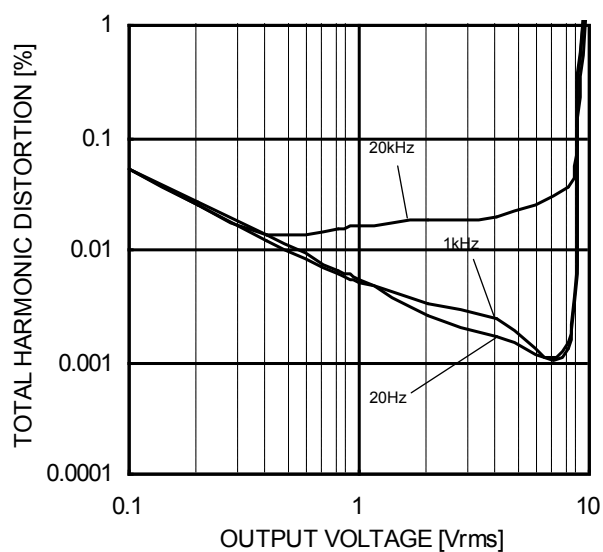

Figure 65.
Total Harmonic Distortion - Output Voltage
(VCC/VEE=+15V/-15V, A_V=20dB,
R_L=2kΩ, 80kHz-LPF, T_A=25°C)

(*The above data is measurement value of typical sample, it is not guaranteed.

OBA4564RFV

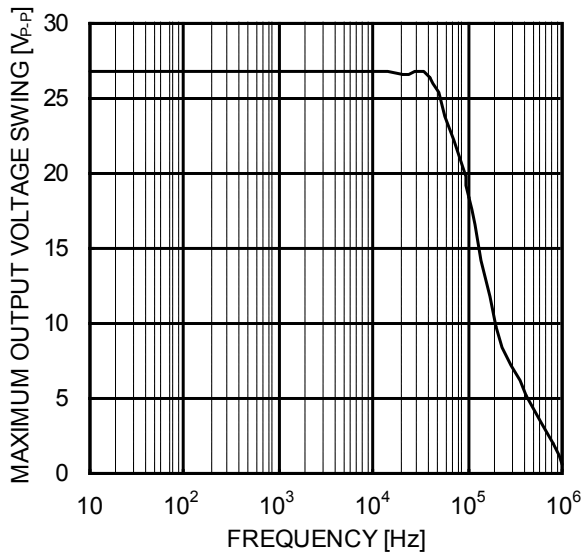

Figure 66.
Maximum Output Voltage Swing – Frequency
(VCC/VEE=+15V/-15V, R_L=2kΩ, T_A =25°C)

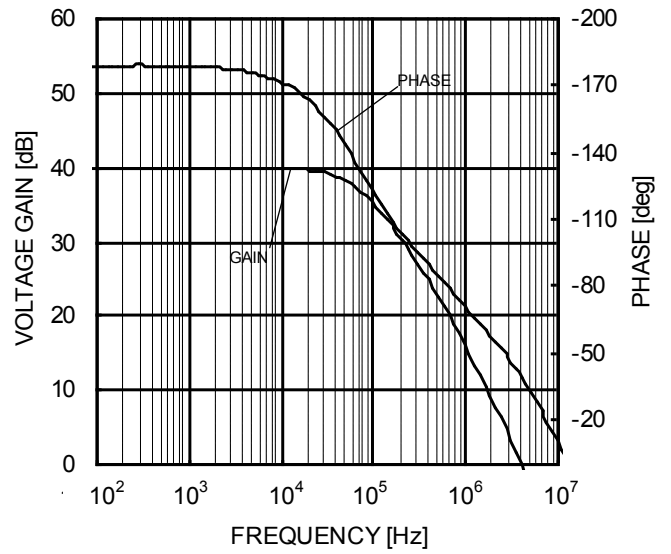

Figure 67.
Voltage Gain - Frequency
(VCC/VEE=+15V/-15V, A_V=40dB, R_L=2kΩ, T_A =25°C)

(*The above data is measurement value of typical sample, it is not guaranteed.

OBA4564WFV

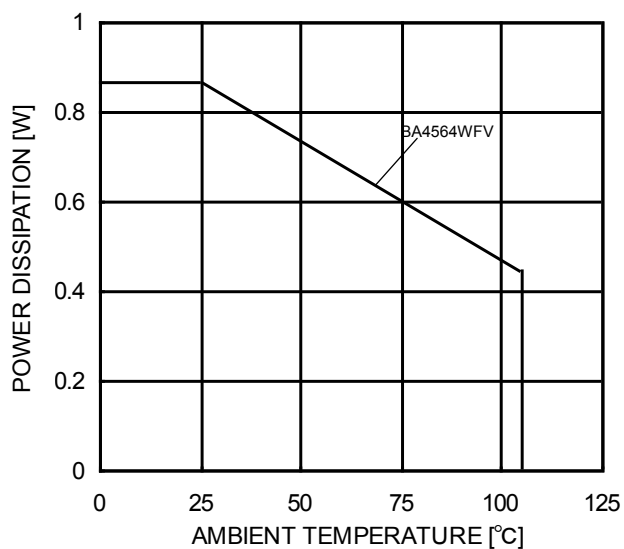

Figure 68.
Derating Curve

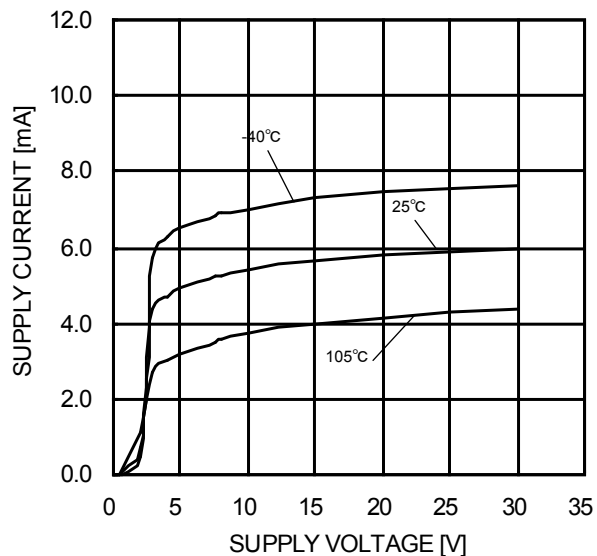

Figure 69.
Supply Current - Supply Voltage

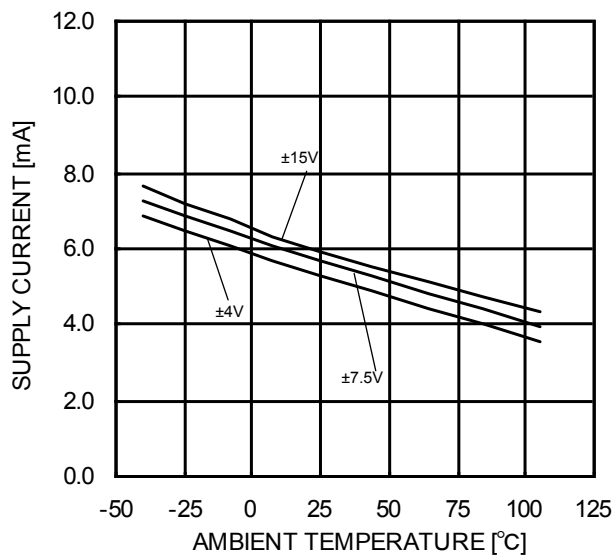

Figure 70.
Supply Current - Ambient Temperature

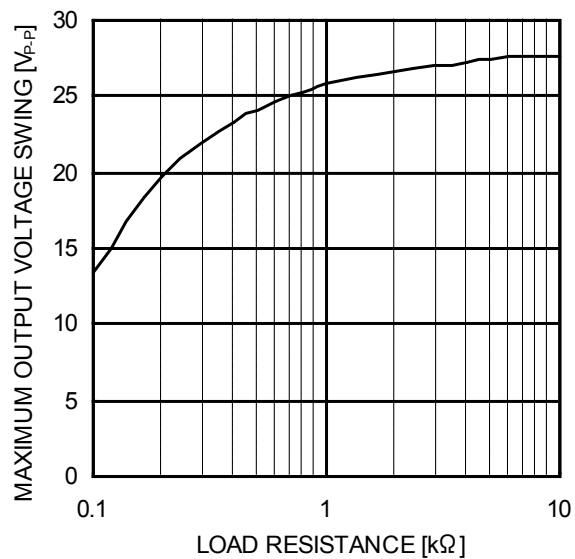

Figure 71.
Maximum Output Voltage Swing
- Load Resistance
(VCC/VEE=+15V/-15V, TA=25°C)

(*The above data is measurement value of typical sample, it is not guaranteed.

OBA4564WFV

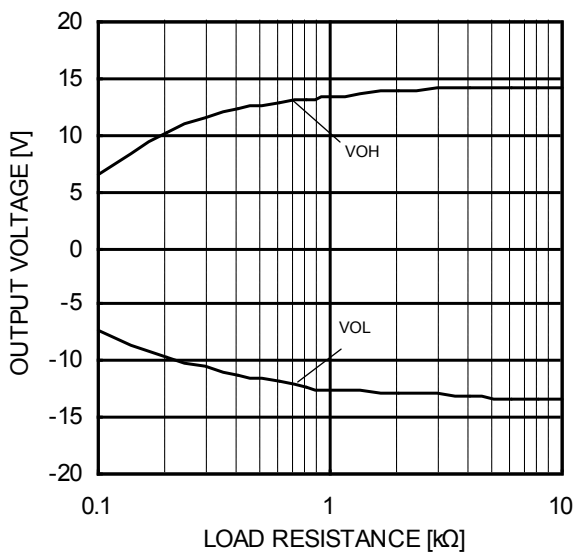

Figure 72.
Maximum Output Voltage
-Load Resistance
(VCC/VEE=+15V/-15V, T_A =25°C)

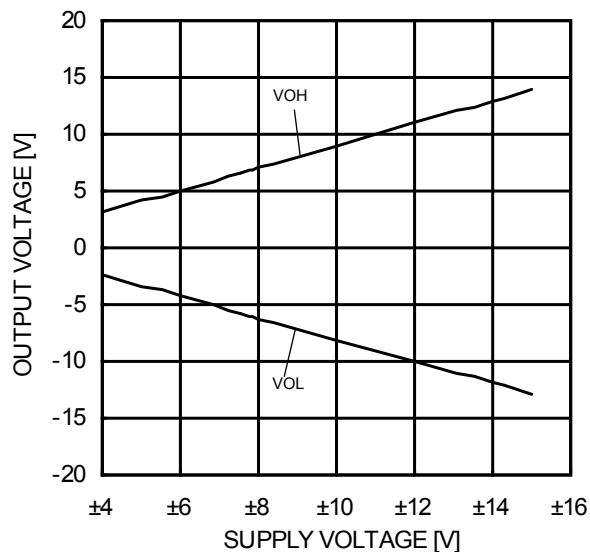

Figure 73.
Maximum Output Voltage
-Supply Voltage
(R_L=2kΩ, T_A =25°C)

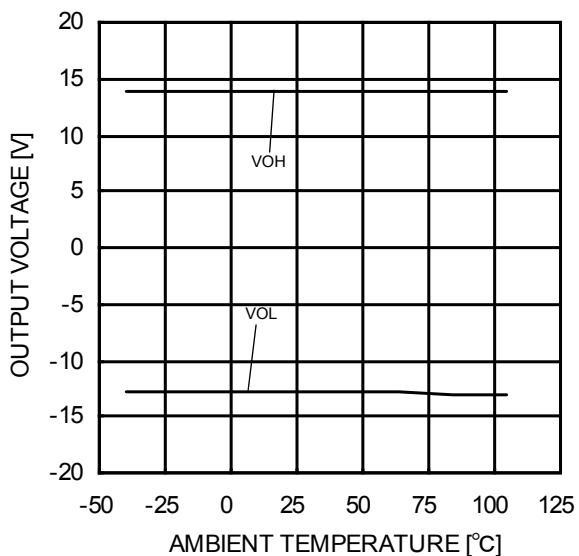

Figure 74.
Maximum Output Voltage
- Ambient Temperature
(VCC/VEE=+15V/-15V, R_L=2kΩ)

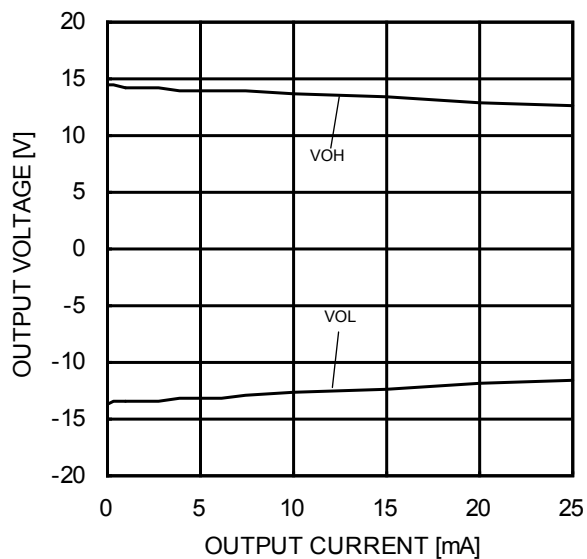

Figure 75.
Maximum Output Voltage
- Output Current
(VCC/VEE=+15V/-15V, T_A =25°C)

(*The above data is measurement value of typical sample, it is not guaranteed.

OBA4564WV

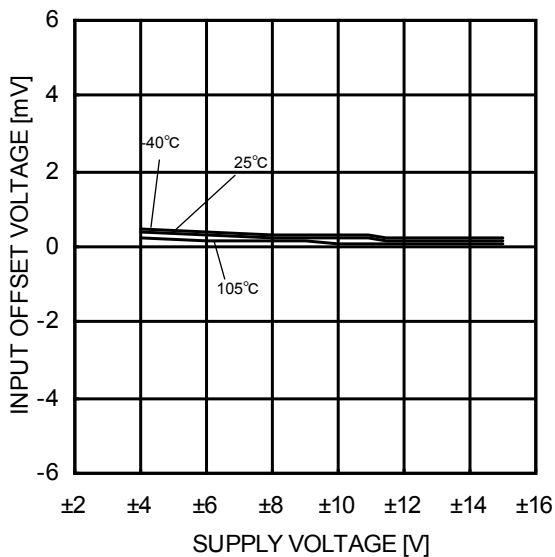

Figure 76.
Input Offset Voltage - Supply Voltage
($V_{ICM}=0V$, $V_{OUT}=0V$)

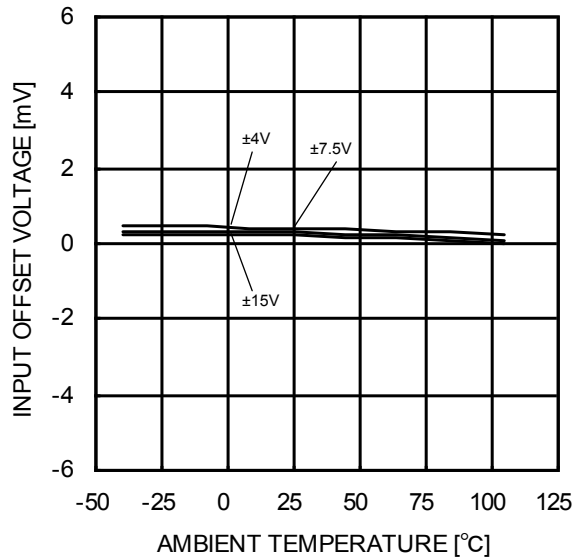

Figure 77.
Input Offset Voltage - Ambient Temperature
($V_{ICM}=0V$, $V_{OUT}=0V$)

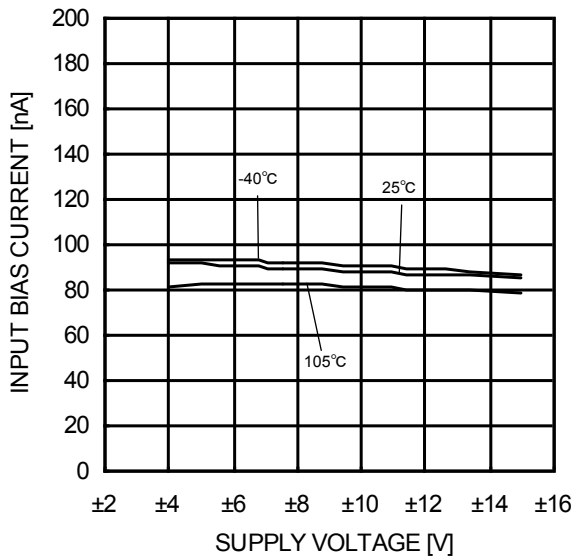

Figure 78.
Input Bias Current - Supply Voltage
($V_{ICM}=0V$, $V_{OUT}=0V$)

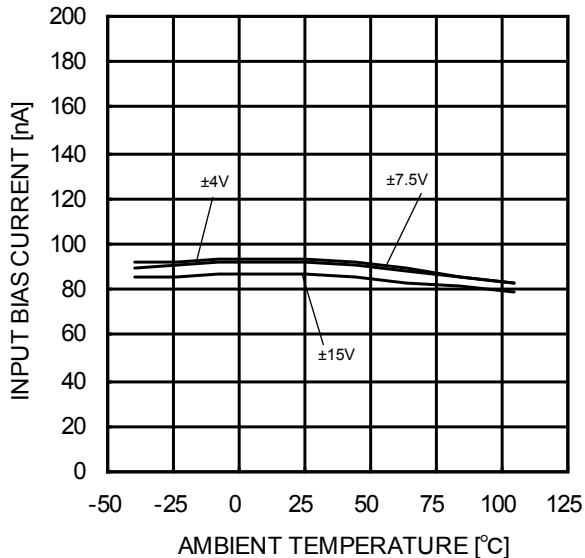

Figure 79.
Input Bias Current - Ambient Temperature
($V_{ICM}=0V$, $V_{OUT}=0V$)

(*The above data is measurement value of typical sample, it is not guaranteed.

OBA4564WV

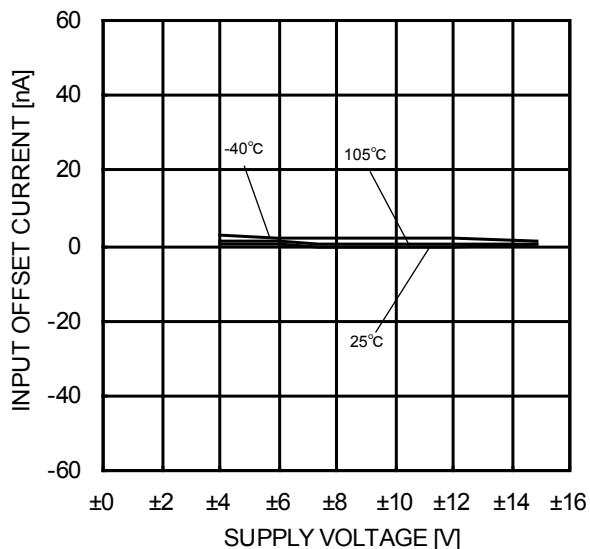

Figure 80.
Input Offset Current - Supply Voltage
($V_{ICM}=0V$, $V_{OUT}=0V$)

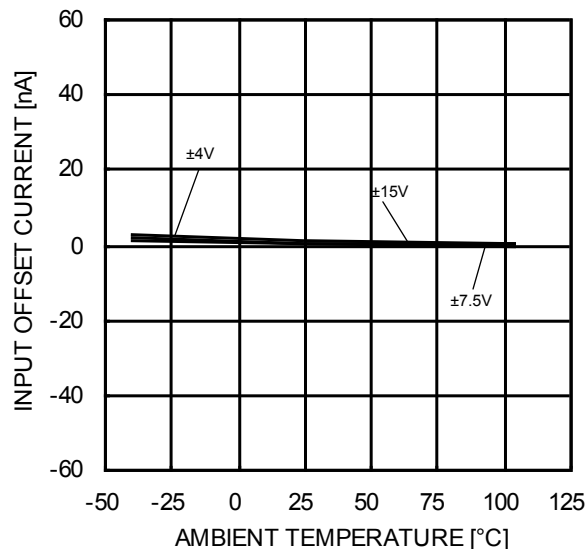

Figure 81.
Input Offset Current - Ambient Temperature
($V_{ICM}=0V$, $V_{OUT}=0V$)

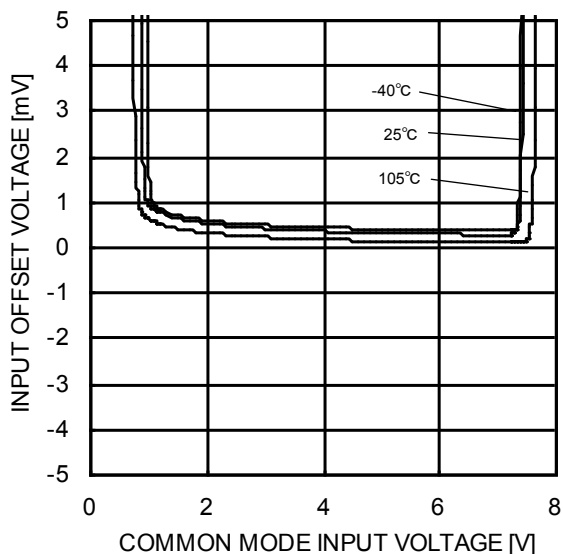

Figure 82.
Input Offset Voltage
- Common Mode Input Voltage
($V_{CC}=8V$, $V_{OUT}=4V$)

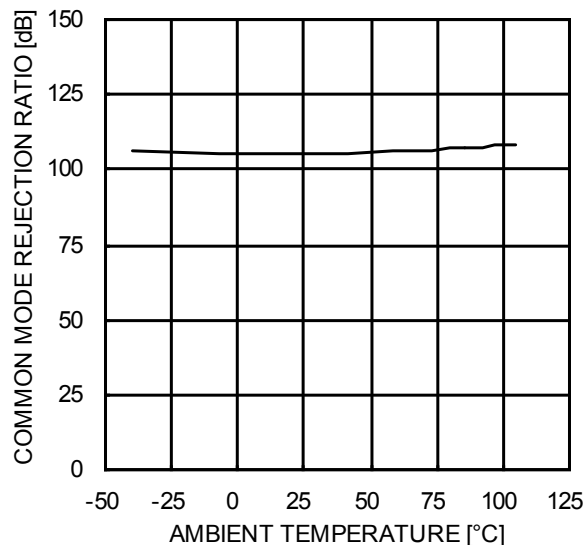

Figure 83.
Common Mode Rejection Ratio
- Ambient Temperature
($V_{CC}/V_{EE}=+15V/-15V$, $V_{ICM}=-12V$ to $+12V$)

(*The above data is measurement value of typical sample, it is not guaranteed.

OBA4564WV

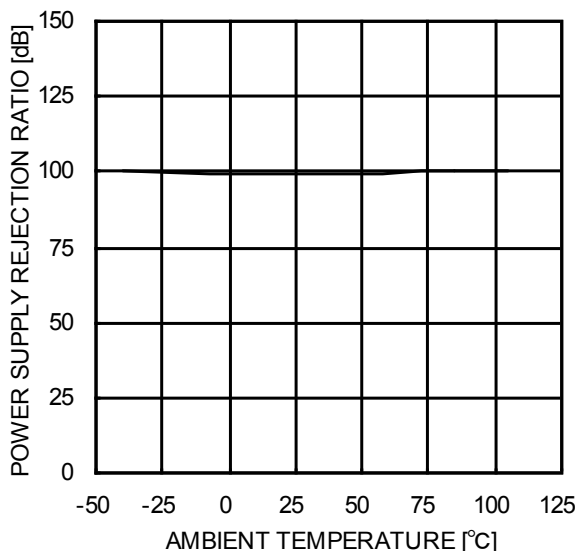

Figure 84.
Power Supply Rejection Ratio
- Ambient Temperature
(VCC/VEE=+4V/-4V to +15V/-15V)

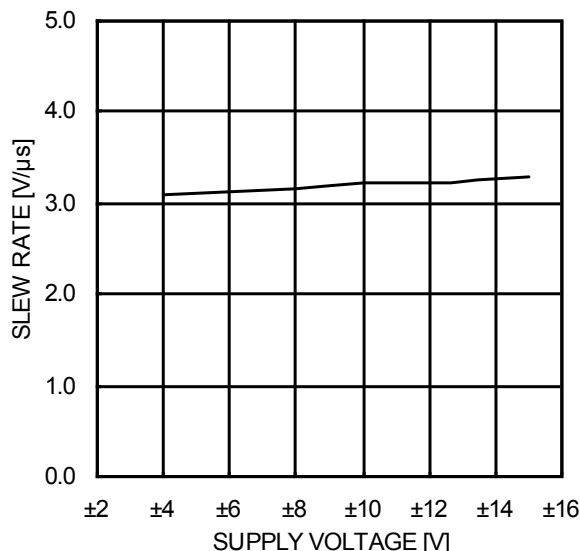

Figure 85.
Slew Rate - Supply Voltage
(CL=100pF, RL=2kΩ, TA =25°C)

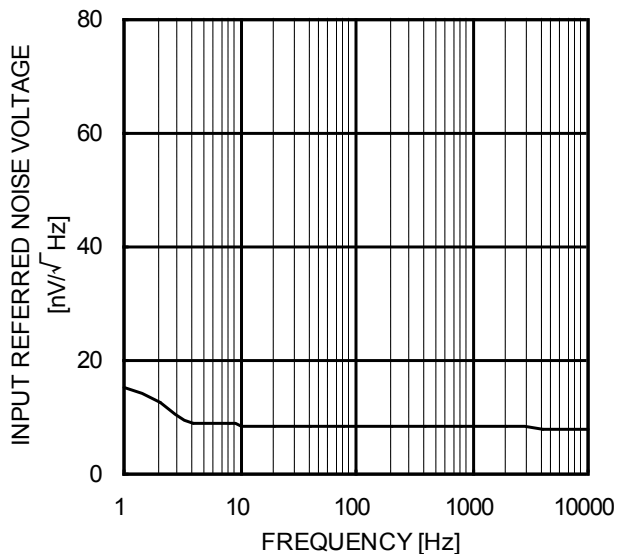

Figure 86.
Equivalent Input Noise Voltage - Frequency
(VCC/VEE=+15V/-15V, RS=100Ω, TA =25°C)

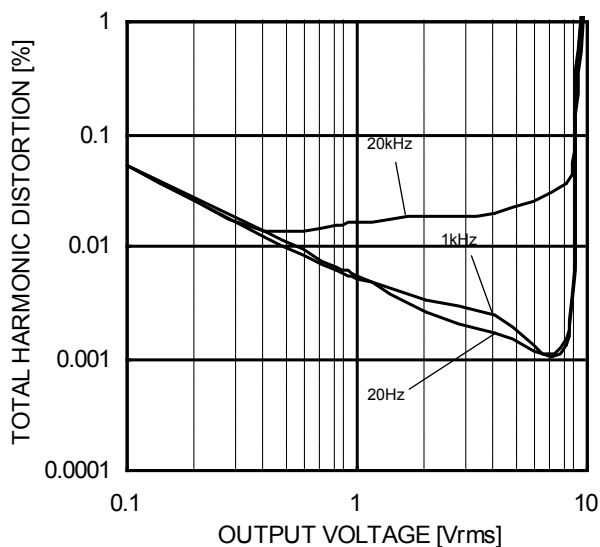

Figure 87.
Total Harmonic Distortion - Output Voltage
(VCC/VEE=+15V/-15V, AV=20dB, RL=2kΩ, 80kHz-LPF, TA =25°C)

(*The above data is measurement value of typical sample, it is not guaranteed.

OBA4564WFV

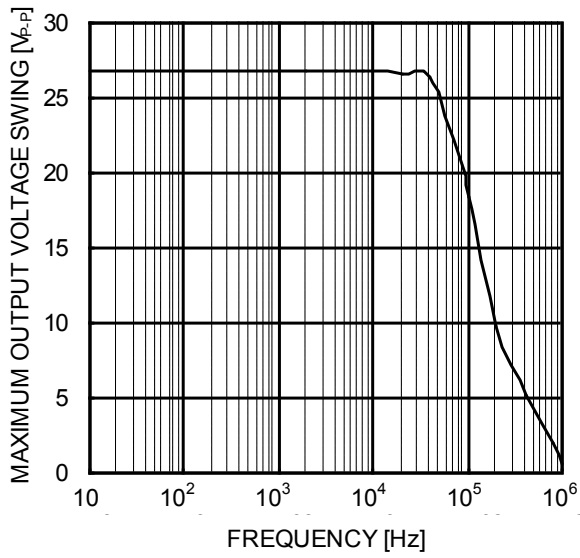

Figure 88.
Maximum Output Voltage Swing – Frequency
(VCC/VEE=+15V/-15V, R_L=2kΩ, T_A =25°C)

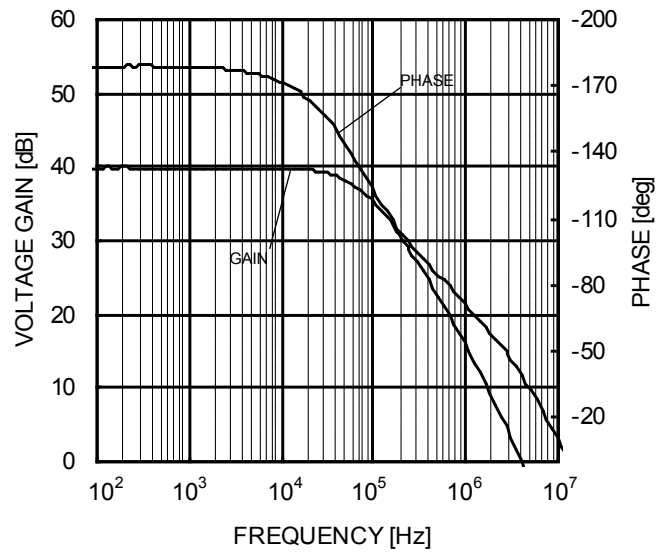

Figure 89.
Voltage Gain - Frequency
(VCC/VEE=+15V/-15V, A_V=40dB, R_L=2kΩ, T_A =25°C)

(*The above data is measurement value of typical sample, it is not guaranteed.

Application Information
Test Circuit1 NULL method

VCC, VEE, E_K, V_{ICM} Unit: V

Parameter	V _F	S1	S2	S3	VCC	VEE	E _K	V _{ICM}	Calculation
Input Offset Voltage	V _{F1}	ON	ON	OFF	15	-15	0	0	1
Input Offset Current	V _{F2}	OFF	OFF	OFF	15	-15	0	0	2
Input Bias Current	V _{F3}	OFF	ON	OFF	15	-15	0	0	3
	V _{F4}	ON	OFF				0	0	
Large Signal Voltage Gain	V _{F5}	ON	ON	ON	15	-15	0	0	4
	V _{F6}				15	-15	0	0	
Common-mode Rejection Ratio (Input common-mode Voltage Range)	V _{F7}	ON	ON	OFF	3	-27	-12	0	5
	V _{F8}				27	-3	12	0	
Power Supply Rejection Ratio	V _{F9}	ON	ON	OFF	4	-4	0	0	6
	V _{F10}				15	-15	0	0	

-Calculation-

1. Input Offset Voltage (V_{IO})

$$V_{IO} = \frac{|V_{F1}|}{1+R_F/R_S} \text{ [V]}$$

2. Input Offset Current (I_{IO})

$$I_{IO} = \frac{|V_{F2}-V_{F1}|}{R_I \times (1+R_F/R_S)} \text{ [A]}$$

3. Input Bias Current (I_B)

$$I_B = \frac{|V_{F4}-V_{F3}|}{2 \times R_I \times (1+R_F/R_S)} \text{ [A]}$$

4. Large Signal Voltage Gain (A_V)

$$A_V = 20 \text{Log} \frac{\Delta E_K \times (1+R_F/R_S)}{|V_{F5}-V_{F6}|} \text{ [dB]}$$

5. Common-mode Rejection Ration (CMRR)

$$\text{CMRR} = 20 \text{Log} \frac{\Delta V_{ICM} \times (1+R_F/R_S)}{|V_{F8}-V_{F7}|} \text{ [dB]}$$

6. Power supply rejection ratio (PSRR)

$$\text{PSRR} = 20 \text{Log} \frac{\Delta V_{CC} \times (1+R_F/R_S)}{|V_{F10} - V_{F9}|} \text{ [dB]}$$

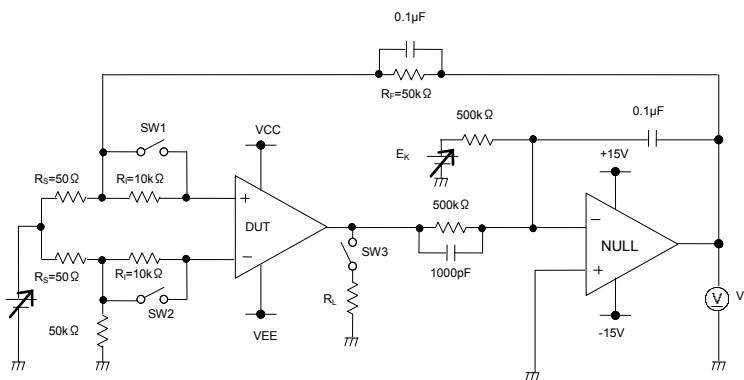

Figure 90. Test Circuit1 (one channel only)

Test Circuit 2 Switch Condition

SW No.	SW1	SW2	SW3	SW4	SW5	SW6	SW7	SW8	SW9	SW10	SW11	SW12	SW13	SW14
Supply Current	OFF	OFF	OFF	ON	OFF	ON	OFF	OFF	OFF	OFF	OFF	OFF	OFF	OFF
High Level Output Voltage	OFF	OFF	ON	OFF	OFF	ON	OFF	OFF	ON	OFF	OFF	OFF	ON	OFF
Low Level Output Voltage	OFF	OFF	ON	OFF	OFF	ON	OFF	OFF	OFF	OFF	OFF	OFF	ON	OFF
Slew Rate	OFF	OFF	OFF	ON	OFF	OFF	OFF	ON	ON	ON	OFF	OFF	OFF	OFF
Unity Gain Frequency	OFF	ON	OFF	OFF	ON	ON	OFF	OFF	ON	ON	ON	OFF	OFF	OFF
Total Harmonic Distortion	ON	OFF	OFF	OFF	ON	OFF	ON	OFF	ON	ON	ON	OFF	OFF	OFF
Input Referred Noise Voltage	ON	OFF	OFF	OFF	ON	ON	OFF	OFF	OFF	OFF	ON	OFF	OFF	OFF

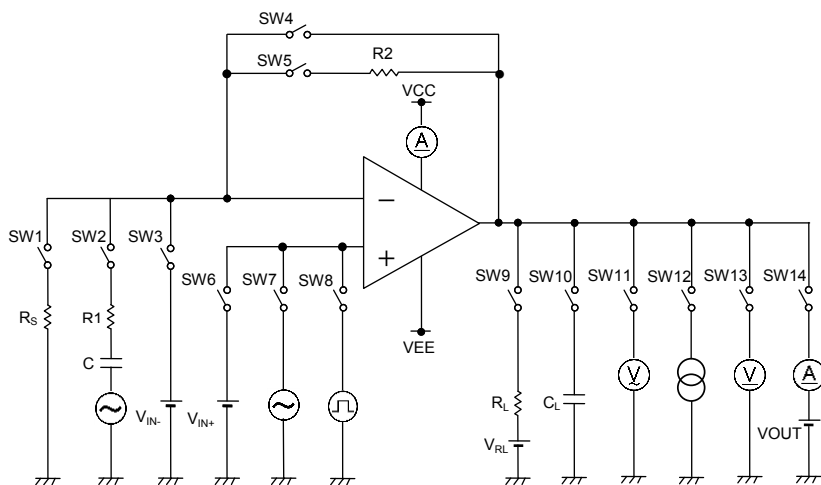

Figure 91. Test Circuit 2 (each Op-Amp)

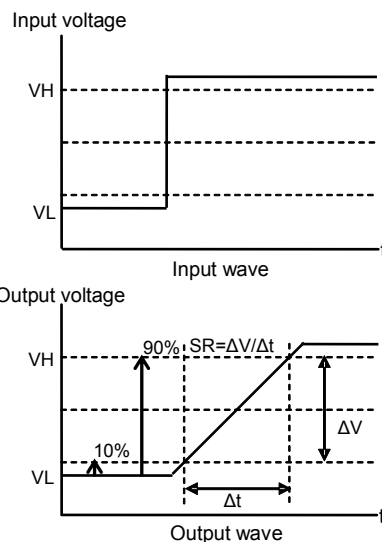

Figure 92. Slew Rate Input/Output Waveform

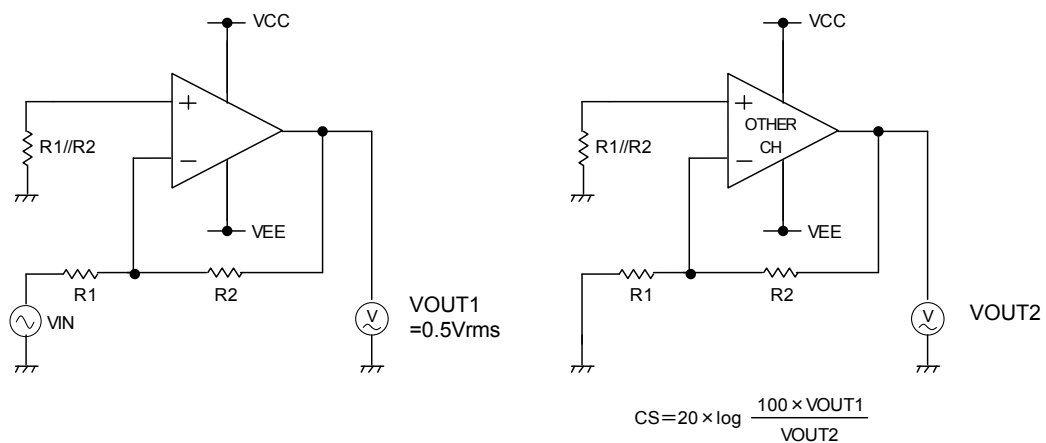

Figure 93. Test Circuit 3(Channel Separation)
(VCC=+15V, VEE=-15V, R1=1kΩ, R2=100kΩ)

Power Dissipation

Power dissipation(total loss) indicates the power that can be consumed by IC at $T_A = 25^{\circ}\text{C}$ (normal temperature). IC is heated when it consumed power, and the temperature of IC chip becomes higher than ambient temperature. The temperature that can be accepted by IC chip depends on circuit configuration, manufacturing process, and consumable power is limited. Power dissipation is determined by the temperature allowed in IC chip(maximum junction temperature) and thermal resistance of package(heat dissipation capability). The maximum junction temperature is typically equal to the maximum value in the storage temperature range. Heat generated by consumed power of IC radiates from the mold resin or lead

frame of the package. The parameter which indicates this heat dissipation capability(hardness of heat release)is called thermal resistance, represented by the symbol $\theta_{JA}^{\circ}\text{C/W}$. The temperature of IC inside the package can be estimated by this thermal resistance. Figure 94.(a) shows the model of thermal resistance of the package. Thermal resistance θ_{JA} , ambient temperature T_A , junction temperature T_{JMAX} , and power dissipation P_D can be calculated by the equation below:

$$\theta_{JA} = (T_{JMAX} - T_A) / P_D \quad ^{\circ}\text{C/W}$$

Derating curve in Figure 94. (b) indicates power that can be consumed by IC with reference to ambient temperature. Power that can be consumed by IC begins to attenuate at certain ambient temperature. This gradient is determined by thermal resistance θ_{JA} . Thermal resistance θ_{JA} depends on chip size, power consumption, package, ambient temperature, package condition, wind velocity, etc even when the same of package is used. Thermal reduction curve indicates a reference value measured at a specified condition. Figure 95.(c), to , (e) show a derating curve for an example of BA4560xxx, BA4560Rxxx, BA4564RFV, BA4564WV.

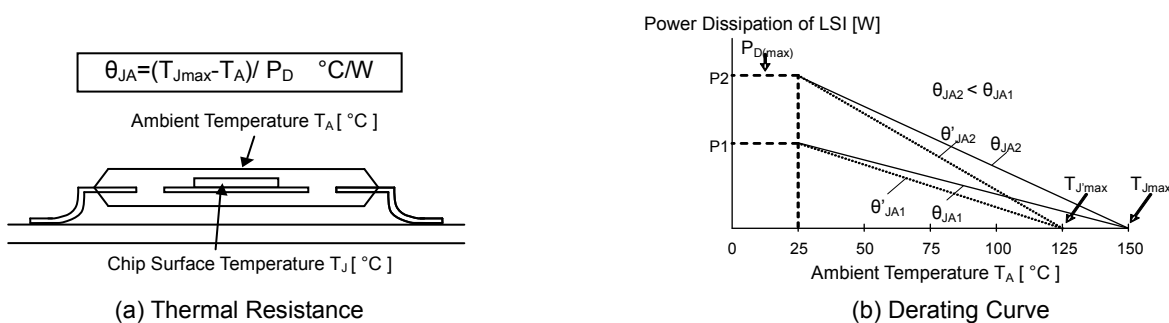
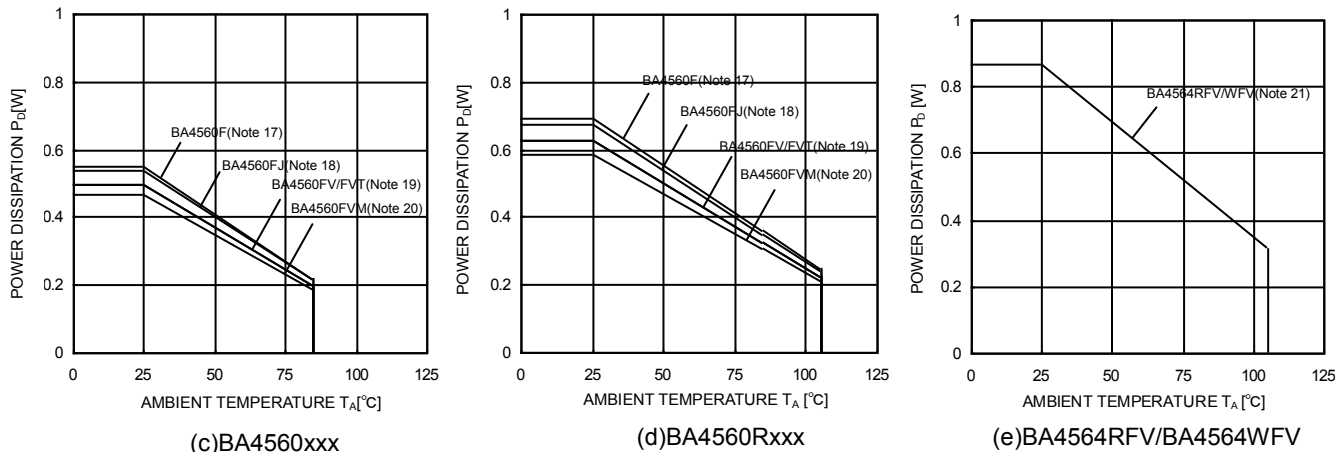

Figure 94. Thermal Resistance and Derating Curve



(Note 17)	(Note 18)	(Note 19)	(Note 20)	(Note 21)	Unit
5.5	5.4	5.0	4.7	7.0	mW/°C

When using the unit above $T_A=25^{\circ}\text{C}$, subtract the value above per degree $^{\circ}\text{C}$. Permissible dissipation is the value. Permissible dissipation is the value when FR4 glass epoxy board 70mm × 70mm × 1.6mm (cooper foil area below 3%) is mounted.

Figure 95. Derating Curve

Examples of Circuit

○Voltage Follower

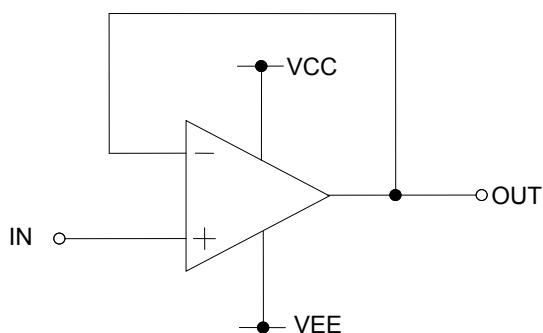

Figure 96. Voltage Follower Circuit

Voltage gain is 0dB.

Using this circuit, the output voltage (OUT) is configured to be equal to the input voltage (IN). This circuit also stabilizes the output voltage (OUT) due to high input impedance and low output impedance. Computation for output voltage (OUT) is shown below. $OUT=IN$

○Inverting Amplifier

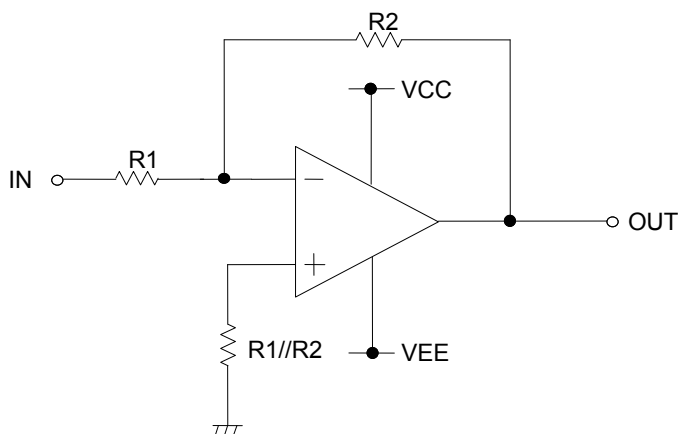

Figure 97. Inverting Amplifier Circuit

For inverting amplifier, input voltage (IN) is amplified by a voltage gain and depends on the ratio of R1 and R2. The out-of-phase output voltage is shown in the next expression

$$OUT=-(R2/R1) \cdot IN$$

This circuit has input impedance equal to R1.

○Non-inverting Amplifier

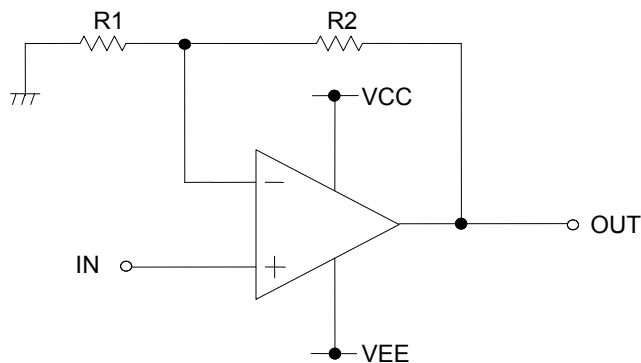

Figure 98. Non-inverting Amplifier Circuit

For non-inverting amplifier, input voltage (IN) is amplified by a voltage gain, which depends on the ratio of R1 and R2. The output voltage (OUT) is in-phase with the input voltage (IN) and is shown in the next expression.

$$OUT=(1 + R2/R1) \cdot IN$$

Effectively, this circuit has high input impedance since its input side is the same as that of the operational amplifier.

Operational Notes

1. Reverse Connection of Power Supply

Connecting the power supply in reverse polarity can damage the IC. Take precautions against reverse polarity when connecting the power supply, such as mounting an external diode between the power supply and the IC's power supply pins.

2. Power Supply Lines

Design the PCB layout pattern to provide low impedance supply lines. Separate the ground and supply lines of the digital and analog blocks to prevent noise in the ground and supply lines of the digital block from affecting the analog block. Furthermore, connect a capacitor to ground at all power supply pins. Consider the effect of temperature and aging on the capacitance value when using electrolytic capacitors.

3. Ground Voltage

Ensure that no pins are at a voltage below that of the ground pin at any time, even during transient condition.

4. Ground Wiring Pattern

When using both small-signal and large-current ground traces, the two ground traces should be routed separately but connected to a single ground at the reference point of the application board to avoid fluctuations in the small-signal ground caused by large currents. Also ensure that the ground traces of external components do not cause variations on the ground voltage. The ground lines must be as short and thick as possible to reduce line impedance.

5. Thermal Consideration

Should by any chance the power dissipation rating be exceeded the rise in temperature of the chip may result in deterioration of the properties of the chip. The absolute maximum rating of the P_D stated in this specification is when the IC is mounted on a 70mm x 70mm x 1.6mm glass epoxy board. In case of exceeding this absolute maximum rating, increase the board size and copper area to prevent exceeding the P_D rating.

6. Recommended Operating Conditions

These conditions represent a range within which the expected characteristics of the IC can be approximately obtained. The electrical characteristics are guaranteed under the conditions of each parameter.

7. Inrush Current

When power is first supplied to the IC, it is possible that the internal logic may be unstable and inrush current may flow instantaneously due to the internal powering sequence and delays, especially if the IC has more than one power supply. Therefore, give special consideration to power coupling capacitance, power wiring, width of ground wiring, and routing of connections.

8. Operation Under Strong Electromagnetic Field

Operating the IC in the presence of a strong electromagnetic field may cause the IC to malfunction.

9. Testing on Application Boards

When testing the IC on an application board, connecting a capacitor directly to a low-impedance output pin may subject the IC to stress. Always discharge capacitors completely after each process or step. The IC's power supply should always be turned off completely before connecting or removing it from the test setup during the inspection process. To prevent damage from static discharge, ground the IC during assembly and use similar precautions during transport and storage.

10. Inter-pin Short and Mounting Errors

Ensure that the direction and position are correct when mounting the IC on the PCB. Incorrect mounting may result in damaging the IC. Avoid nearby pins being shorted to each other especially to ground, power supply and output pin. Inter-pin shorts could be due to many reasons such as metal particles, water droplets (in very humid environment) and unintentional solder bridge deposited in between pins during assembly to name a few.

Operational Notes – continued

11. Regarding the Input Pin of the IC

This monolithic IC contains P+ isolation and P substrate layers between adjacent elements in order to keep them isolated. P-N junctions are formed at the intersection of the P layers with the N layers of other elements, creating a parasitic diode or transistor. For example (refer to figure below):

When GND > Pin A and GND > Pin B, the P-N junction operates as a parasitic diode.
 When GND > Pin B, the P-N junction operates as a parasitic transistor.

Parasitic diodes inevitably occur in the structure of the IC. The operation of parasitic diodes can result in mutual interference among circuits, operational faults, or physical damage. Therefore, conditions that cause these diodes to operate, such as applying a voltage lower than the GND voltage to an input pin (and thus to the P substrate) should be avoided.

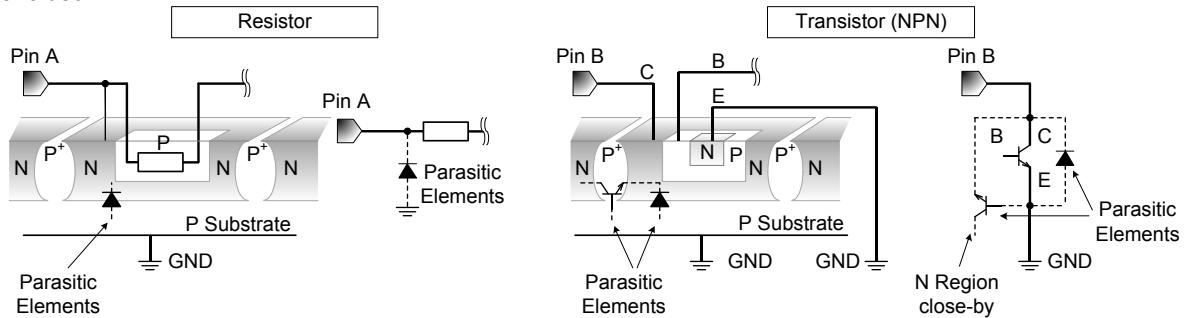

Figure 99. Example of monolithic IC structure

12. Unused Circuits

It is recommended to apply the connection (see Figure 100.) and set the non-inverting input terminal at a potential within the Input Common-mode Voltage Range (VICM) for any unused circuit.

13. Input Voltage

Applying VEE +36V to the input terminal is possible without causing deterioration of the electrical characteristics or destruction, regardless of the supply voltage. However, this does not ensure normal circuit operation. Please note that the circuit operates normally only when the input voltage is within the common mode input voltage range of the electric characteristics.

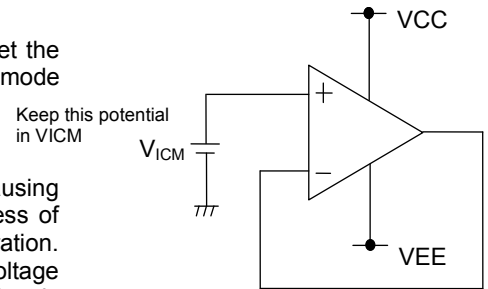

Figure 100. Example of Application Circuit for Unused Op-amp

14. Power Supply(single/dual)

The operational amplifier operates when the voltage supplied is between VCC and VEE. Therefore, the single supply operational amplifier can be used as dual supply operational amplifier as well.

15. IC Handling

When pressure is applied to the IC through warp on the printed circuit board, the characteristics may fluctuate due to the piezo effect. Be careful with the warp on the printed circuit board.

16. The IC Destruction Caused by Capacitive Load

The IC may be damaged when VCC terminal and VEE terminal is shorted with the charged output terminal capacitor. When IC is used as an operational amplifier or as an application circuit where oscillation is not activated by an output capacitor, output capacitor must be kept below 0.1µF in order to prevent the damage mentioned above.

Physical Dimension, Tape and Reel Information

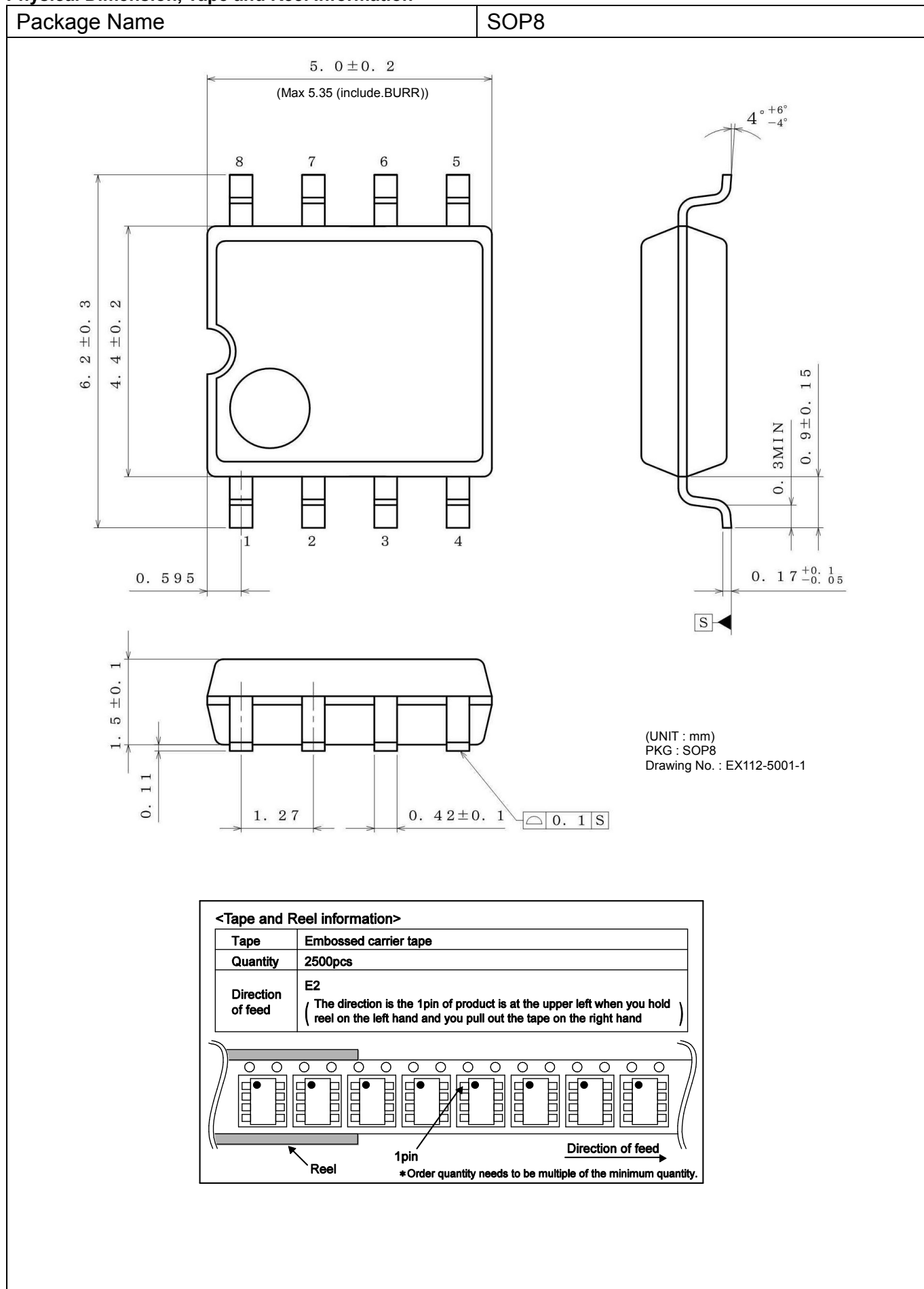

Physical Dimension, Tape and Reel Information

Package Name	SSOP-B8
--------------	---------

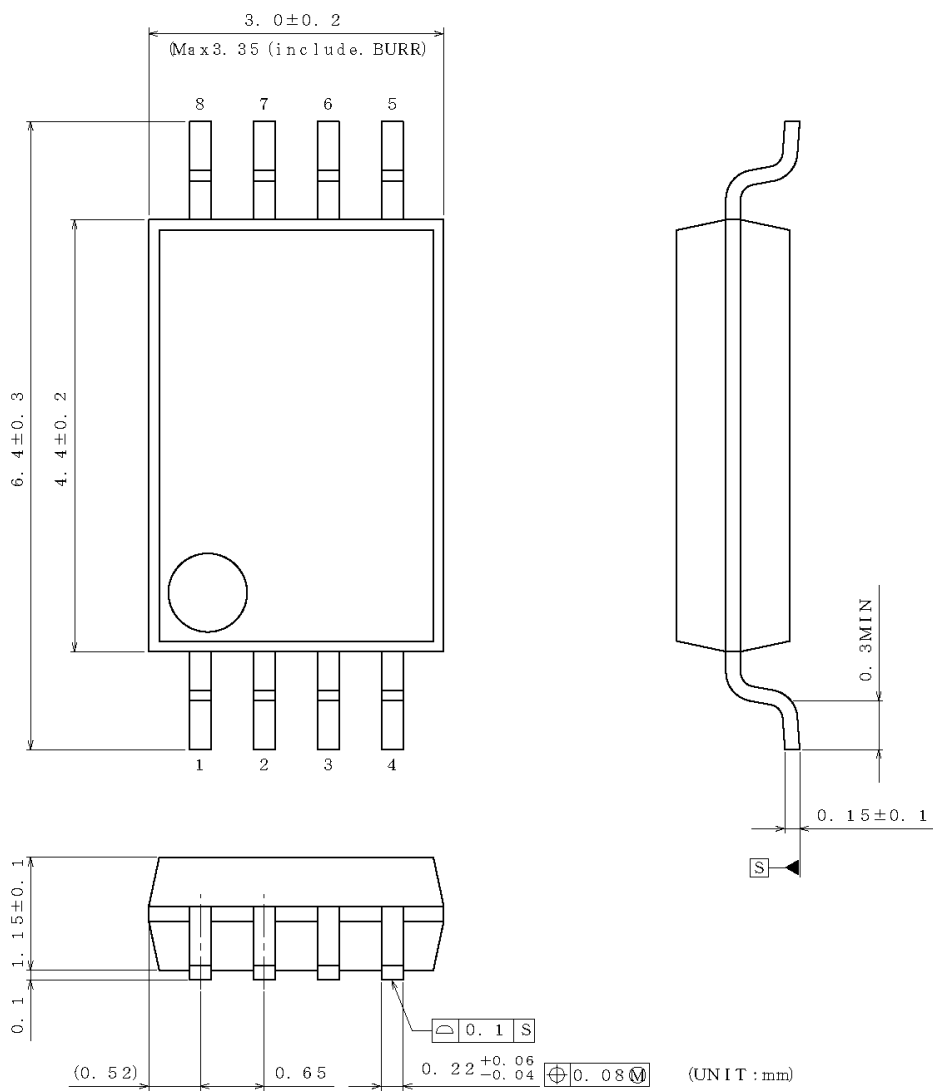

(UNIT : mm)
 PKG : SSOP-B8
 Drawing No. EX151-5002

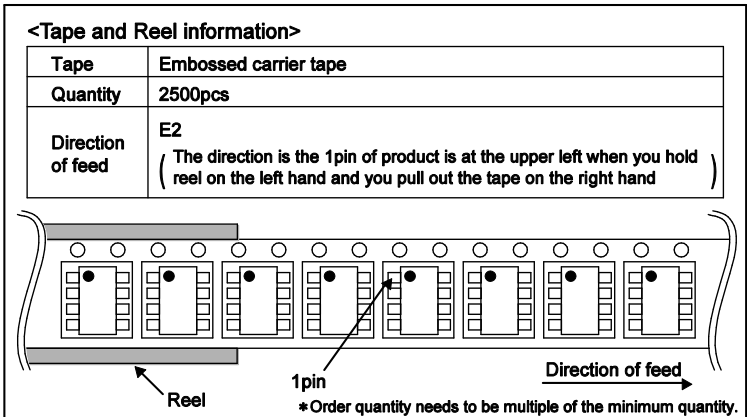

Physical Dimension, Tape and Reel Information

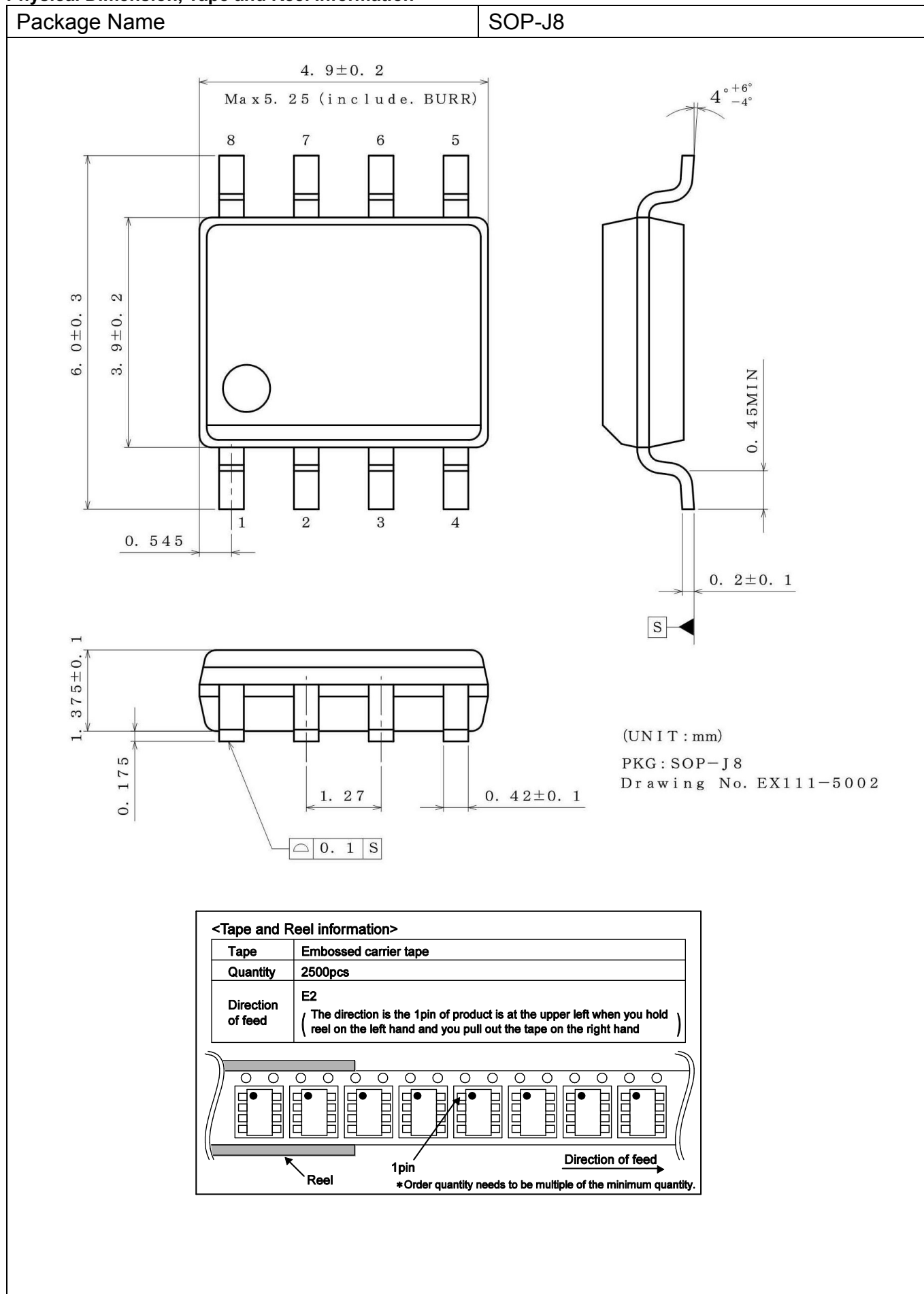

Physical Dimension, Tape and Reel Information

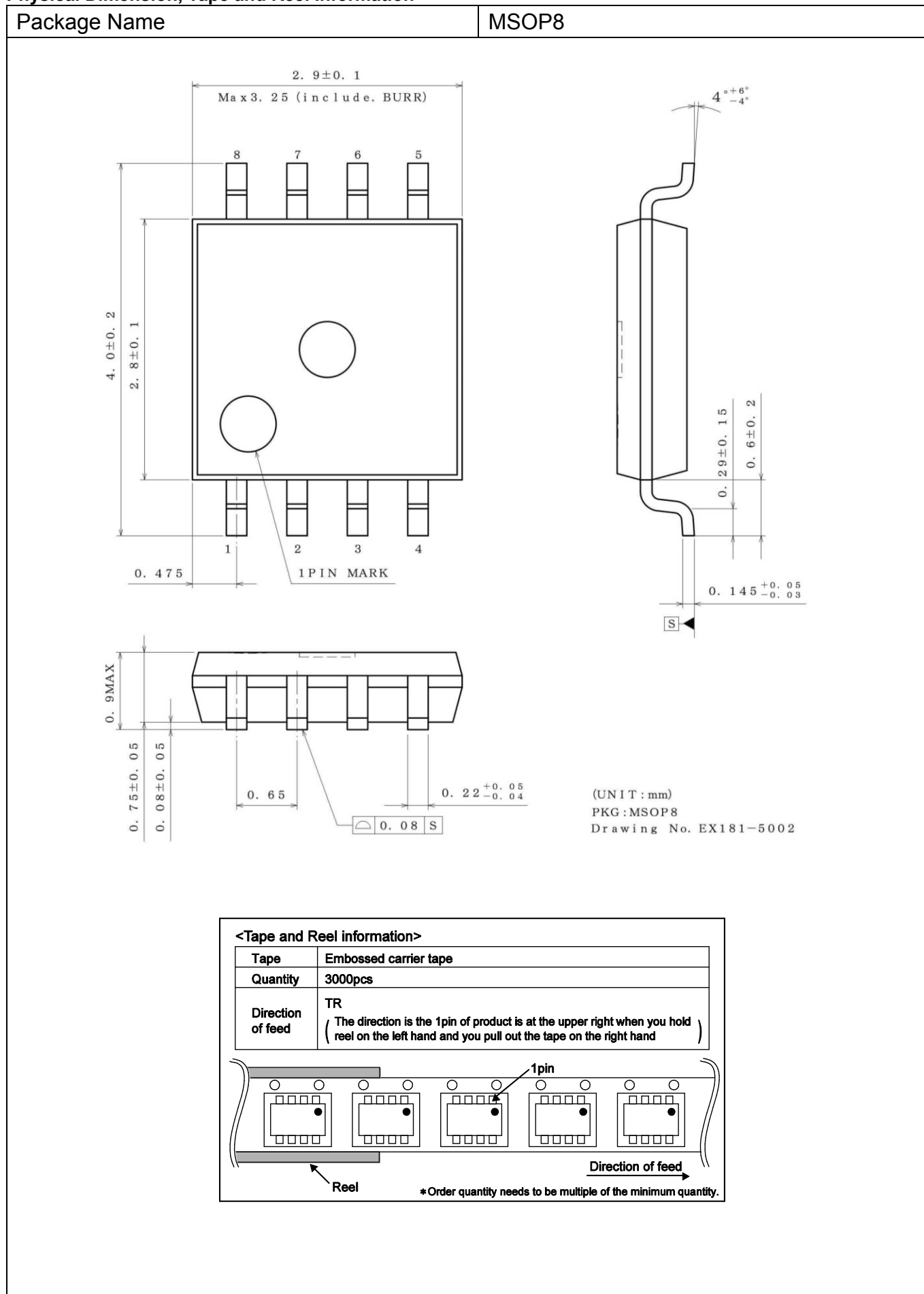

Physical Dimension, Tape and Reel Information

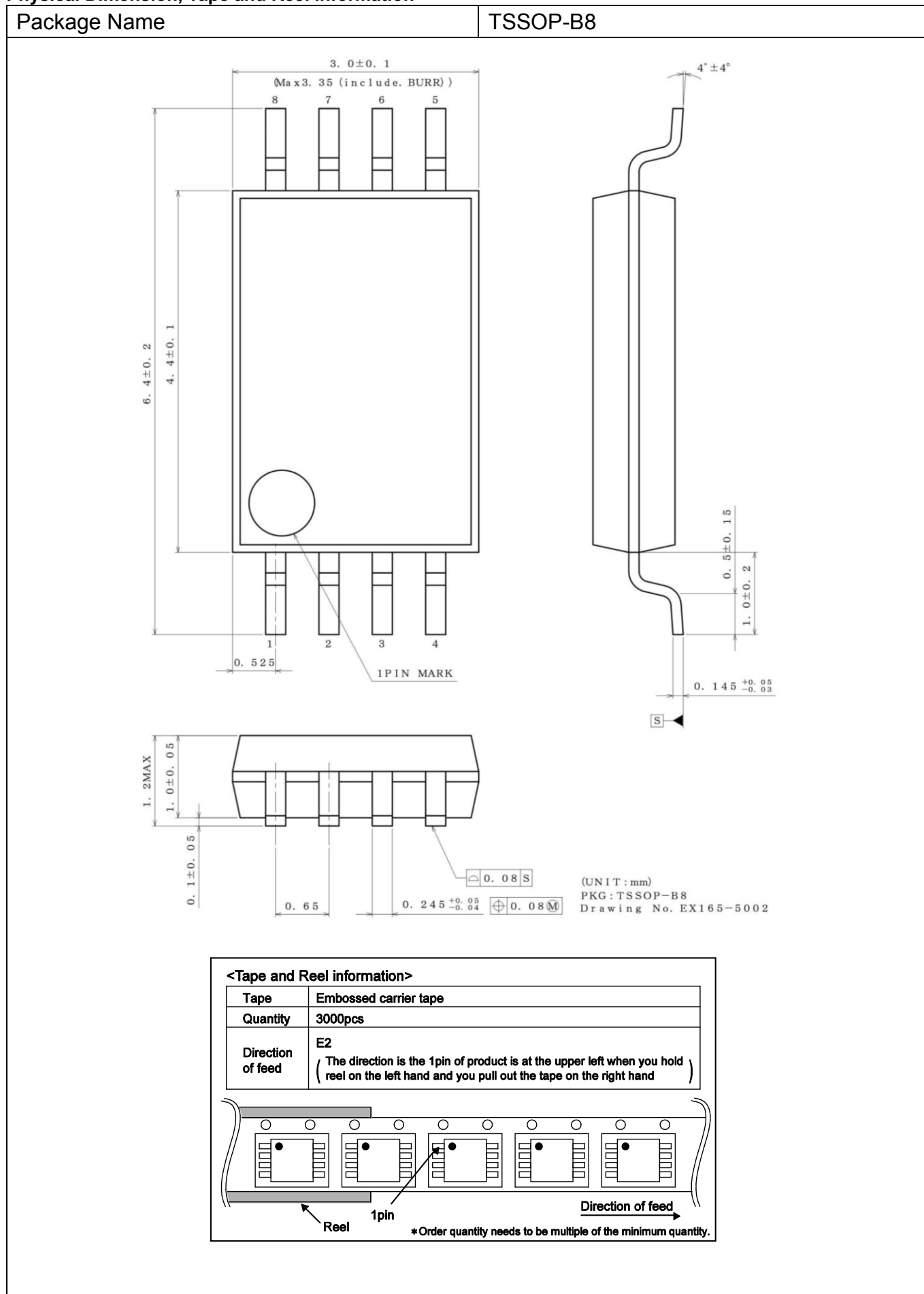

Physical Dimension, Tape and Reel Information

Package Name	SSOP-B14
--------------	----------

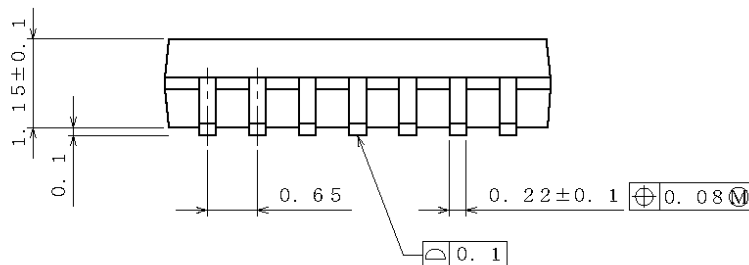
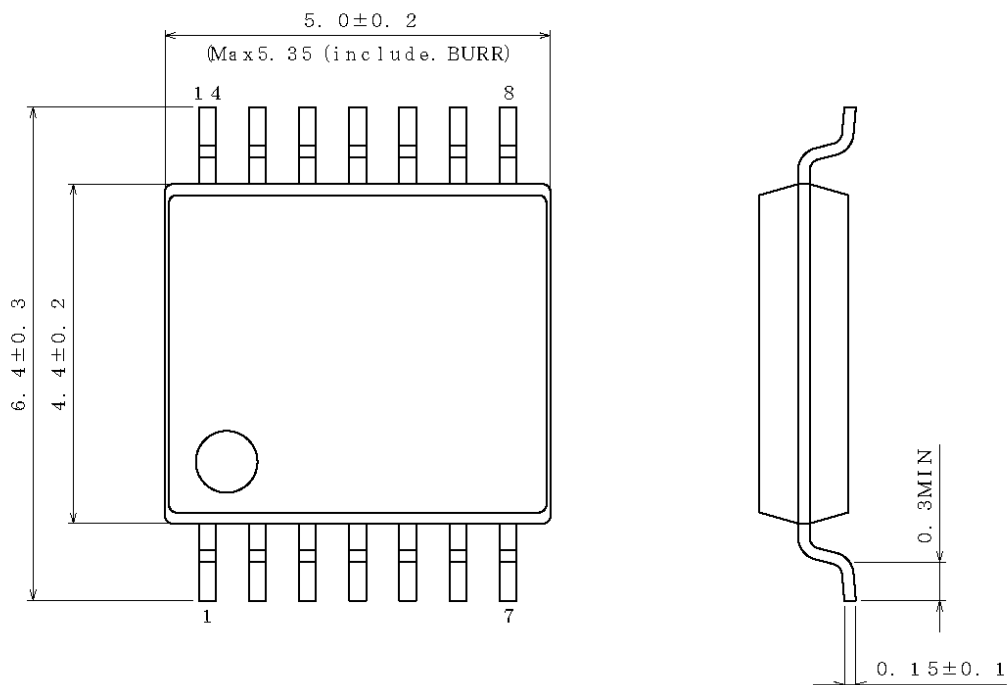

(UNIT : mm)
 PKG : SSOP-B14
 Drawing No. EX152-5002

<Tape and Reel information>

Tape	Embossed carrier tape
Quantity	2500pcs
Direction of feed	E2 (The direction is the 1pin of product is at the upper left when you hold reel on the left hand and you pull out the tape on the right hand)

Reel 1pin Direction of feed

*Order quantity needs to be multiple of the minimum quantity.

Marking Diagrams

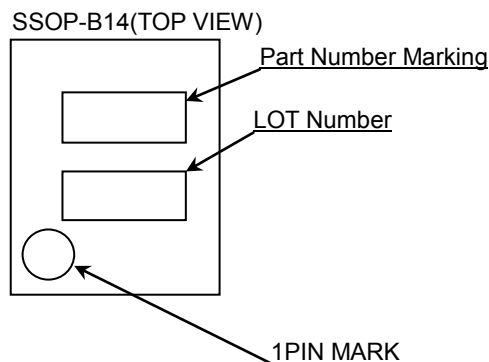
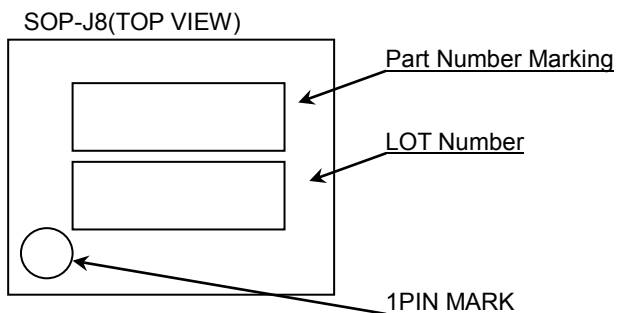
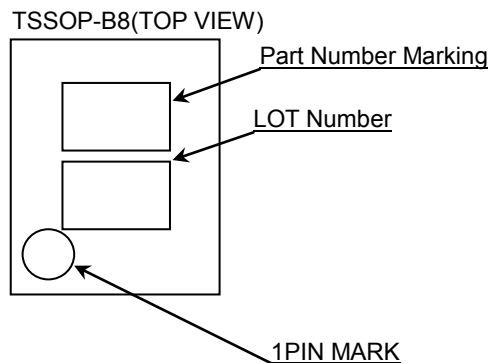
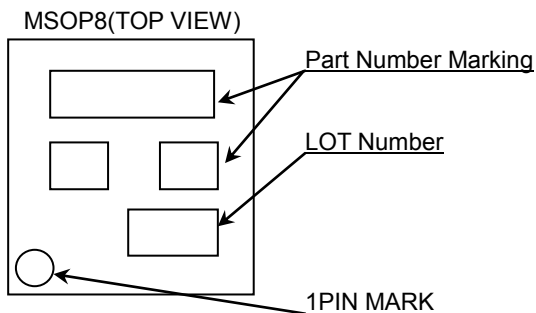
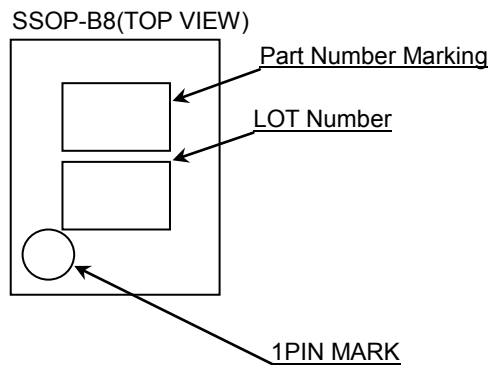
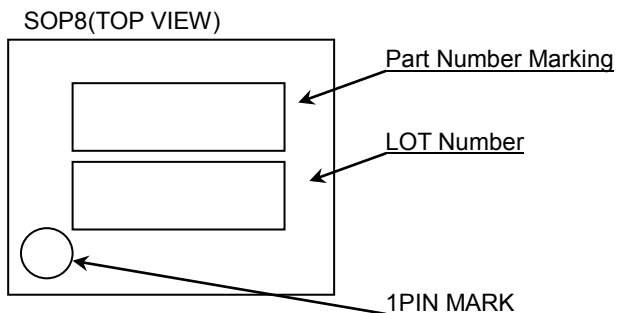

Product Name		Package Type	Marking
BA4560	F	SOP8	4560
	FJ	SOP-J8	
	FV	SSOP-B8	
	FVT	TSSOP-B8	
	FVM	MSOP8	
	FJ	SOP-J8	
BA4560R	F	SOP8	4560R
	FJ	SOP-J8	
	FV	SSOP-B8	
	FVT	TSSOP-B8	
	FVM	MSOP8	
	FJ	SOP-J8	
BA4564R	FV	SSOP-B14	4564R
BA4564W	FV	SSOP-B14	4564W

Revision History

Date	Revision	Changes
10/May/2012	001	New Release
07/Sep/2012	002	Added Line-up
19/Nov/2014	003	Page.3 Absolute Maximum Ratings : Added Input Current

Notice

Precaution on using ROHM Products

- Our Products are designed and manufactured for application in ordinary electronic equipments (such as AV equipment, OA equipment, telecommunication equipment, home electronic appliances, amusement equipment, etc.). If you intend to use our Products in devices requiring extremely high reliability (such as medical equipment ^(Note 1), transport equipment, traffic equipment, aircraft/spacecraft, nuclear power controllers, fuel controllers, car equipment including car accessories, safety devices, etc.) and whose malfunction or failure may cause loss of human life, bodily injury or serious damage to property ("Specific Applications"), please consult with the ROHM sales representative in advance. Unless otherwise agreed in writing by ROHM in advance, ROHM shall not be in any way responsible or liable for any damages, expenses or losses incurred by you or third parties arising from the use of any ROHM's Products for Specific Applications.

(Note1) Medical Equipment Classification of the Specific Applications

JAPAN	USA	EU	CHINA
CLASS III	CLASS III	CLASS II b	CLASS III
CLASS IV		CLASS III	

- ROHM designs and manufactures its Products subject to strict quality control system. However, semiconductor products can fail or malfunction at a certain rate. Please be sure to implement, at your own responsibilities, adequate safety measures including but not limited to fail-safe design against the physical injury, damage to any property, which a failure or malfunction of our Products may cause. The following are examples of safety measures:
 - Installation of protection circuits or other protective devices to improve system safety
 - Installation of redundant circuits to reduce the impact of single or multiple circuit failure
- Our Products are designed and manufactured for use under standard conditions and not under any special or extraordinary environments or conditions, as exemplified below. Accordingly, ROHM shall not be in any way responsible or liable for any damages, expenses or losses arising from the use of any ROHM's Products under any special or extraordinary environments or conditions. If you intend to use our Products under any special or extraordinary environments or conditions (as exemplified below), your independent verification and confirmation of product performance, reliability, etc. prior to use, must be necessary:
 - Use of our Products in any types of liquid, including water, oils, chemicals, and organic solvents
 - Use of our Products outdoors or in places where the Products are exposed to direct sunlight or dust
 - Use of our Products in places where the Products are exposed to sea wind or corrosive gases, including Cl₂, H₂S, NH₃, SO₂, and NO₂
 - Use of our Products in places where the Products are exposed to static electricity or electromagnetic waves
 - Use of our Products in proximity to heat-producing components, plastic cords, or other flammable items
 - Sealing or coating our Products with resin or other coating materials
 - Use of our Products without cleaning residue of flux (even if you use no-clean type fluxes, cleaning residue of flux is recommended); or Washing our Products by using water or water-soluble cleaning agents for cleaning residue after soldering
 - Use of the Products in places subject to dew condensation
- The Products are not subject to radiation-proof design.
- Please verify and confirm characteristics of the final or mounted products in using the Products.
- In particular, if a transient load (a large amount of load applied in a short period of time, such as pulse. is applied, confirmation of performance characteristics after on-board mounting is strongly recommended. Avoid applying power exceeding normal rated power; exceeding the power rating under steady-state loading condition may negatively affect product performance and reliability.
- De-rate Power Dissipation (Pd) depending on Ambient temperature (Ta). When used in sealed area, confirm the actual ambient temperature.
- Confirm that operation temperature is within the specified range described in the product specification.
- ROHM shall not be in any way responsible or liable for failure induced under deviant condition from what is defined in this document.

Precaution for Mounting / Circuit board design

- When a highly active halogenous (chlorine, bromine, etc.) flux is used, the residue of flux may negatively affect product performance and reliability.
- In principle, the reflow soldering method must be used on a surface-mount products, the flow soldering method must be used on a through hole mount products. If the flow soldering method is preferred on a surface-mount products, please consult with the ROHM representative in advance.

For details, please refer to ROHM Mounting specification

Precautions Regarding Application Examples and External Circuits

1. If change is made to the constant of an external circuit, please allow a sufficient margin considering variations of the characteristics of the Products and external components, including transient characteristics, as well as static characteristics.
2. You agree that application notes, reference designs, and associated data and information contained in this document are presented only as guidance for Products use. Therefore, in case you use such information, you are solely responsible for it and you must exercise your own independent verification and judgment in the use of such information contained in this document. ROHM shall not be in any way responsible or liable for any damages, expenses or losses incurred by you or third parties arising from the use of such information.

Precaution for Electrostatic

This Product is electrostatic sensitive product, which may be damaged due to electrostatic discharge. Please take proper caution in your manufacturing process and storage so that voltage exceeding the Products maximum rating will not be applied to Products. Please take special care under dry condition (e.g. Grounding of human body / equipment / solder iron, isolation from charged objects, setting of Ionizer, friction prevention and temperature / humidity control).

Precaution for Storage / Transportation

1. Product performance and soldered connections may deteriorate if the Products are stored in the places where:
 - [a] the Products are exposed to sea winds or corrosive gases, including Cl₂, H₂S, NH₃, SO₂, and NO₂
 - [b] the temperature or humidity exceeds those recommended by ROHM
 - [c] the Products are exposed to direct sunshine or condensation
 - [d] the Products are exposed to high Electrostatic
2. Even under ROHM recommended storage condition, solderability of products out of recommended storage time period may be degraded. It is strongly recommended to confirm solderability before using Products of which storage time is exceeding the recommended storage time period.
3. Store / transport cartons in the correct direction, which is indicated on a carton with a symbol. Otherwise bent leads may occur due to excessive stress applied when dropping of a carton.
4. Use Products within the specified time after opening a humidity barrier bag. Baking is required before using Products of which storage time is exceeding the recommended storage time period.

Precaution for Product Label

QR code printed on ROHM Products label is for ROHM's internal use only.

Precaution for Disposition

When disposing Products please dispose them properly using an authorized industry waste company.

Precaution for Foreign Exchange and Foreign Trade act

Since our Products might fall under controlled goods prescribed by the applicable foreign exchange and foreign trade act, please consult with ROHM representative in case of export.

Precaution Regarding Intellectual Property Rights

1. All information and data including but not limited to application example contained in this document is for reference only. ROHM does not warrant that foregoing information or data will not infringe any intellectual property rights or any other rights of any third party regarding such information or data. ROHM shall not be in any way responsible or liable for infringement of any intellectual property rights or other damages arising from use of such information or data.:
2. No license, expressly or implied, is granted hereby under any intellectual property rights or other rights of ROHM or any third parties with respect to the information contained in this document.

Other Precaution

1. This document may not be reprinted or reproduced, in whole or in part, without prior written consent of ROHM.
2. The Products may not be disassembled, converted, modified, reproduced or otherwise changed without prior written consent of ROHM.
3. In no event shall you use in any way whatsoever the Products and the related technical information contained in the Products or this document for any military purposes, including but not limited to, the development of mass-destruction weapons.
4. The proper names of companies or products described in this document are trademarks or registered trademarks of ROHM, its affiliated companies or third parties.

General Precaution

1. Before you use our Products, you are requested to carefully read this document and fully understand its contents. ROHM shall not be in any way responsible or liable for failure, malfunction or accident arising from the use of any ROHM's Products against warning, caution or note contained in this document.
2. All information contained in this document is current as of the issuing date and subject to change without any prior notice. Before purchasing or using ROHM's Products, please confirm the latest information with a ROHM sales representative.
3. The information contained in this document is provided on an "as is" basis and ROHM does not warrant that all information contained in this document is accurate and/or error-free. ROHM shall not be in any way responsible or liable for any damages, expenses or losses incurred by you or third parties resulting from inaccuracy or errors of or concerning such information.

Mouser Electronics

Authorized Distributor

Click to View Pricing, Inventory, Delivery & Lifecycle Information:

[ROHM Semiconductor:](#)

[BA4560](#) [BA4560F-E2](#) [BA4560RF-E2](#) [BA4560RFV-E2](#) [BA4560RFVM-TR](#) [BA4560FJ-GE2](#) [BA4560FV-GE2](#)
[BA4560FVM-GTR](#) [BA4560FVT-GE2](#) [BA4560RFVT-E2](#) [BA4564WFV-E2](#) [BA4564RFV-E2](#) [BA4560RFJ-GE2](#)