

MPXM2051G, 0 to 50 kPa, Gauge Compensated Pressure Sensors

The MPXM2051G device is a silicon piezoresistive pressure sensor providing a highly accurate and linear voltage output - directly proportional to the applied pressure. The sensor is a single, monolithic silicon diaphragm with the strain gauge and a thin-film resistor network integrated on-chip. The chip is laser trimmed for precise span and offset calibration and temperature compensation.

Features

- Temperature compensated over 0 °C to +85 °C
- Available in easy-to-use tape and reel
- Ratiometric to supply voltage
- Gauge ported

Typical applications

- Pump/motor controllers
- Robotics
- Level indicators
- Medical diagnostics
- Pressure switching
- Non-invasive blood pressure measurement

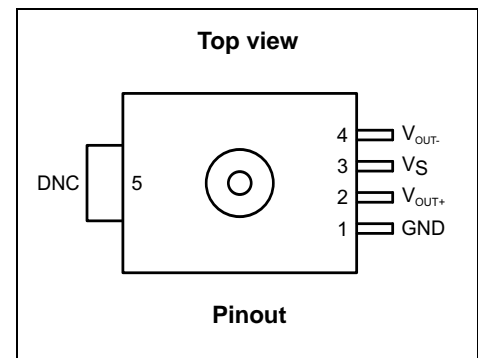
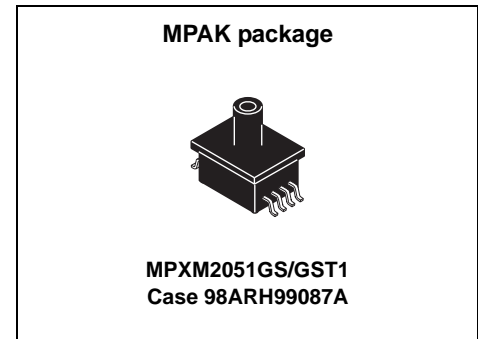
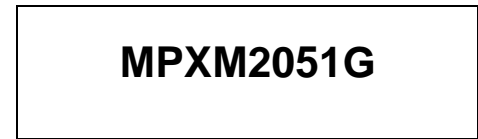

Ordering information									
Device name	Shipping	Package	# of Ports			Pressure type			Device marking
			None	Single	Dual	Gauge	Differential	Absolute	
MPXM2051GS	Rail	98ARH99087A		•				•	MPXM2051GS
MPXM2051GST1	Tape and reel	98ARH99087A		•				•	MPXM2051GS

Freescale reserves the right to change the detail specifications as may be required to permit improvements in the design of its products.

© 2005, 2009, 2015 Freescale Semiconductor, Inc. All rights reserved.



Contents

1	General Description	3
1.1	Block diagram	3
1.2	Pinout	3
2	Mechanical and Electrical Specifications	4
2.1	Maximum Ratings	4
2.2	Operating Characteristics	4
2.3	Voltage output versus applied differential pressure	4
2.4	Linearity	5
3	On-chip Temperature Compensation and Calibration	6
4	Package Information	7
4.1	Package dimensions	7
5	Revision History	9

Related Documentation

The MPXM2051G device features and operations are described in a variety of reference manuals, user guides, and application notes. To find the most-current versions of these documents:

1. Go to the Freescale homepage at:
<http://www.freescale.com/>
2. In the Keyword search box at the top of the page, enter the device number MPXM2051G.
3. In the Refine Your Result pane on the left, click on the Documentation link.

MPXM2051G

1 General Description

1.1 Block diagram

Figure 1 shows a block diagram of the internal circuitry integrated on a pressure sensor chip.

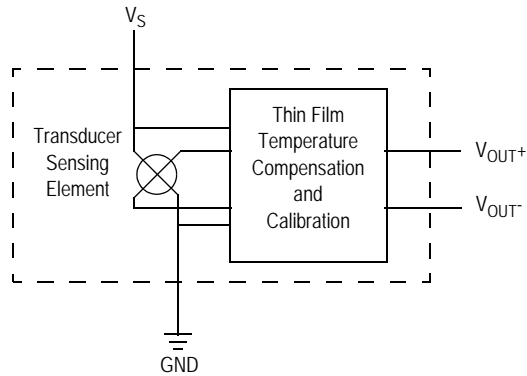

Figure 1. Integrated pressure sensor block diagram

1.2 Pinout

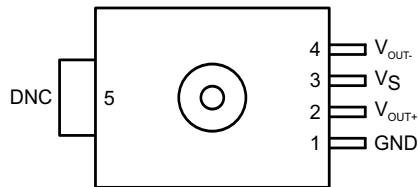

Figure 2. Device pinout (top view)

Table 1. Pin functions

Pin	Name	Function
1	GND	Ground
2	V_{OUT+}	Output voltage
3	V_S	Voltage supply
4	V_{OUT-}	Output voltage
5	DNC	Do not connect to external circuitry or ground.

2 Mechanical and Electrical Specifications

2.1 Maximum ratings

Table 2. Maximum ratings⁽¹⁾

Rating	Symbol	Value	Unit
Maximum Pressure	P_{max}	200	kPa
Storage Temperature	T_{stg}	-40 to +125	°C
Operating Temperature	T_A	-40 to +125	°C

1.Exposure beyond the specified limits may cause permanent damage or degradation to the device.

2.2 Operating characteristics

Table 3. Operating characteristics ($V_S = 10$ Vdc, $T_A = 25^\circ\text{C}$.)

Characteristic	Symbol	Min	Typ	Max	Unit
Pressure Range ⁽¹⁾	P_{OP}	0	—	50	kPa
Supply Voltage ⁽²⁾	V_S	—	10	16	Vdc
Supply Current	I_o	—	6.0	—	mAdc
Full Scale Span ⁽³⁾	V_{FSS}	38.5	40	41.5	mV
Offset ⁽⁴⁾	V_{off}	-1.0	—	1.0	mV
Sensitivity	$\Delta V/\Delta P$	—	0.8	—	mV/kPa
Linearity	—	-0.3	—	0.3	% V_{FSS}
Pressure Hysteresis(0 to 50 kPa)	—	—	± 0.1	—	% V_{FSS}
Temperature Hysteresis (-40°C to +125°C)	—	—	± 0.5	—	% V_{FSS}
Temperature Effect on Full Scale Span	TCV_{FSS}	-1.0	—	1.0	% V_{FSS}
Temperature Effect on Offset	TCV_{off}	-1.0	—	1.0	mV
Input Impedance	Z_{in}	1000	—	2500	Ω
Output Impedance	Z_{out}	1400	—	3000	Ω
Response Time ⁽⁵⁾ (10% to 90%)	t_R	—	1.0	—	ms
Warm-Up	—	—	20	—	ms
Offset Stability ⁽⁶⁾	—	—	± 0.5	—	% V_{FSS}

1. 1.0 kPa (kiloPascal) equals 0.145 psi.

2. Device is ratiometric within this specified excitation range. Operating the device above the specified excitation range may induce additional error due to device self-heating.

3. Full Scale Span (V_{FSS}) is defined as the algebraic difference between the output voltage at full rated pressure and the output voltage at the minimum rated pressure.

4. Offset (V_{off}) is defined as the output voltage at the minimum rated pressure.

5. Response Time is defined as the time for the incremental change in the output to go from 10% to 90% of its final value when subjected to a specified step change in pressure.

6. Offset stability is the product's output deviation when subjected to 1000 hours of Pulsed Pressure, Temperature Cycling with Bias Test.

2.3 Voltage output versus applied differential pressure

The differential voltage output of the sensor is directly proportional to the differential pressure applied.

The output voltage of the differential or gauge sensor increases with increasing pressure applied to the pressure side relative to the vacuum side. Similarly, output voltage increases as increasing vacuum is applied to the vacuum side relative to the pressure side.

2.4 Linearity

Linearity refers to how well a transducer's output follows the equation: $V_{OUT} = V_{OFF} + \text{sensitivity} \times P$ over the operating pressure range. There are two basic methods for calculating nonlinearity: (1) end point straight line fit (see Figure 3) or (2) a least squares best line fit. While a least squares fit gives the "best case" linearity error (lower numerical value), the calculations required are burdensome.

Conversely, an end point fit will give the "worst case" error (often more desirable in error budget calculations) and the calculations are more straightforward for the user. The specified pressure sensor linearities are based on the end point straight line method measured at the midrange pressure.

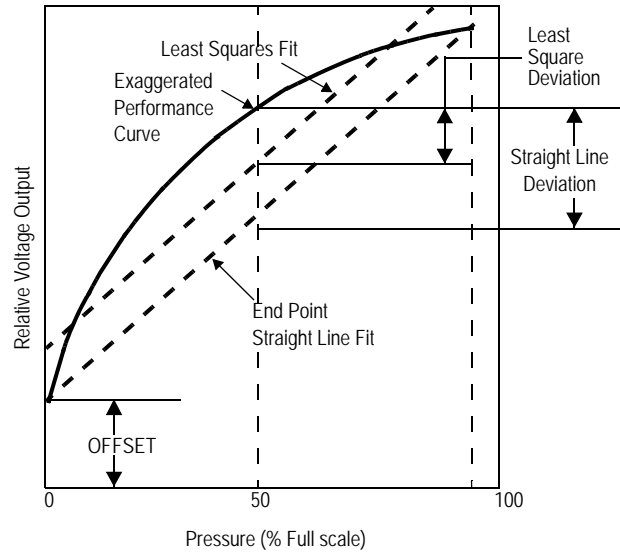

Figure 3. Linearity specification comparison

3 On-chip Temperature Compensation and Calibration

Figure 4 shows the minimum, maximum and typical output characteristics of the MPXM2051G series at 25 °C. The output is directly proportional to the differential pressure and is essentially a straight line.

A silicone gel isolates the die surface and wire bonds from the environment, while allowing the pressure signal to be transmitted to the silicon diaphragm.

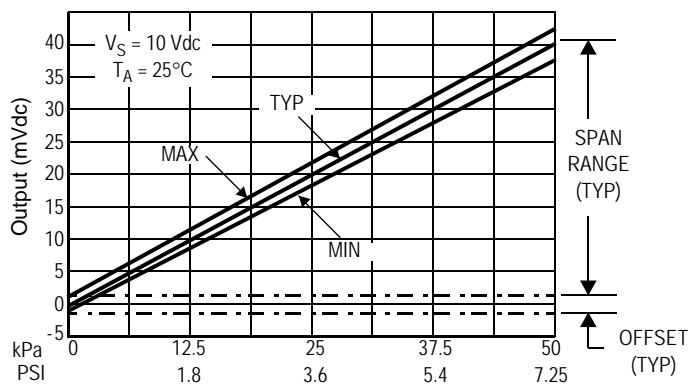
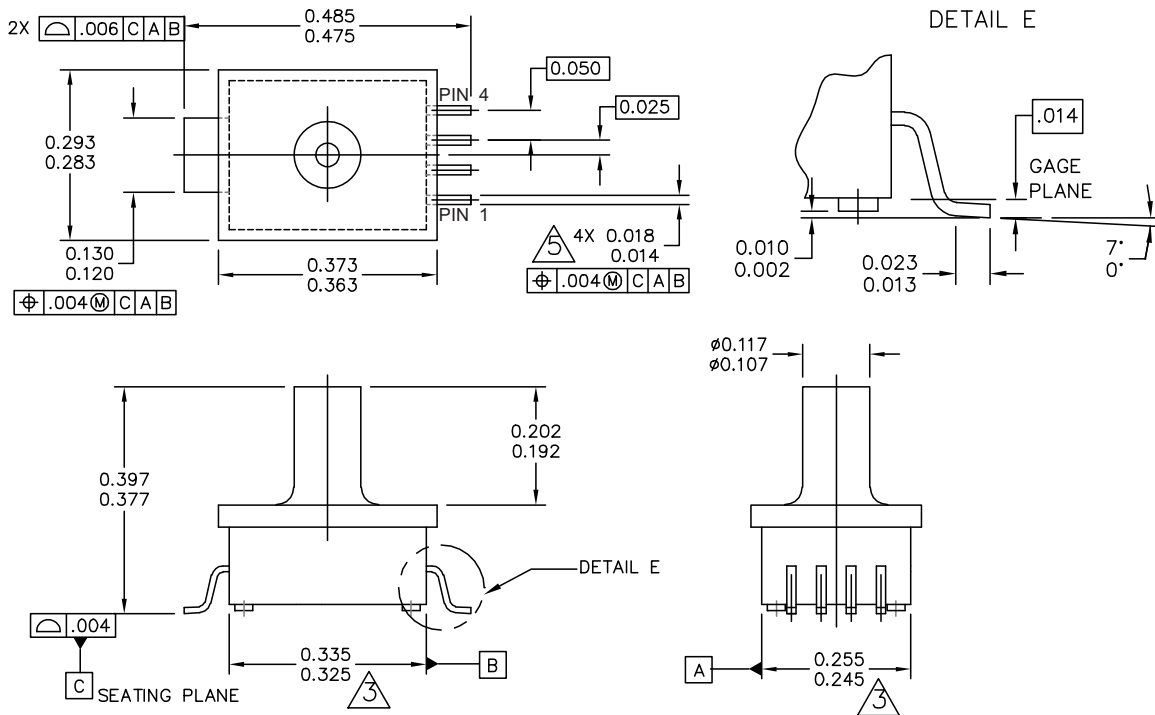

Figure 4. Output versus pressure differential

4 Package Information

4.1 Package dimensions

This drawing is located at http://cache.freescale.com/files/shared/doc/package_info/98ARH99087A.pdf.



© FREESCALE SEMICONDUCTOR, INC. ALL RIGHTS RESERVED.	MECHANICAL OUTLINE	PRINT VERSION NOT TO SCALE
TITLE: 5 LD M-PAC, PORTED	DOCUMENT NO: 98ARH99087A	REV: A
	CASE NUMBER: 1320A-02	22 JUL 2005
	STANDARD: NON-JEDEC	

Case 98ARH99087A, 5-lead M-PAC



NOTES:

1. DIMENSIONS ARE IN INCHES.

2. INTERPRET DIMENSIONS AND TOLERANCES PER ASME Y14.5M-1994.

3. DIMENSIONS DOES NOT INCLUDE MOLD FLASH OR PROTRUSION. MOLD FLASH OR PROTRUSION SHALL NOT EXCEED .006" PER SIDE.

4. ALL VERTICAL SURFACES TO BE 5" MAXIMUM.

5. DIMENSION DOES NOT INCLUDE DAMBAR PROTRUSION. ALLOWABLE DAMBAR PROTRUSION SHALL BE .008 MAXIMUM.

© FREESCALE SEMICONDUCTOR, INC. ALL RIGHTS RESERVED.	MECHANICAL OUTLINE	PRINT VERSION NOT TO SCALE	
TITLE: 5 LD M-PAC, PORTED	DOCUMENT NO: 98ARH99087A	REV: A	
	CASE NUMBER: 1320A-02	22 JUL 2005	
	STANDARD: NON-JEDEC		

Case 98ARH99087A, 5-lead M-PAC

5 Revision History

Table 4. Revision history

Revision number	Revision date	Description of changes
3.0	11/2015	• Updated format.



How to Reach Us:

Home Page:

freescale.com

Web Support:

freescale.com/support

Information in this document is provided solely to enable system and software implementers to use Freescale products. There are no express or implied copyright licenses granted hereunder to design or fabricate any integrated circuits based on the information in this document.

Freescale reserves the right to make changes without further notice to any products herein. Freescale makes no warranty, representation, or guarantee regarding the suitability of its products for any particular purpose, nor does Freescale assume any liability arising out of the application or use of any product or circuit, and specifically disclaims any and all liability, including without limitation consequential or incidental damages. "Typical" parameters that may be provided in Freescale data sheets and/or specifications can and do vary in different applications, and actual performance may vary over time. All operating parameters, including "typicals," must be validated for each customer application by customer's technical experts. Freescale does not convey any license under its patent rights nor the rights of others. Freescale sells products pursuant to standard terms and conditions of sale, which can be found at the following address: freescale.com/salestermsandconditions.

Freescale and the Freescale logo are trademarks of Freescale Semiconductor, Inc., Reg. U.S. Pat. & Tm. Off. All other product or service names are the property of their respective owners.

© 2005, 2009, 2015 Freescale Semiconductor, Inc.

Document Number: MPXM2051G

Rev. 3.0

11/2015



Mouser Electronics

Authorized Distributor

Click to View Pricing, Inventory, Delivery & Lifecycle Information:

[NXP:](#)

[MPXM2051GS](#) [MPXM2051GST1](#)