

SURFACE MOUNT LED RED/GREEN/BLUE, 1210 PACKAGE

BIVAR

SM1210RGB

- ◆ Industry Standard Package
- ◆ RoHS Compliant
- ◆ Three Chips in One Package
- ◆ Water Clear Lens
- ◆ Wide Viewing Angle
- ◆ Ideal for Status Indication and Lighting

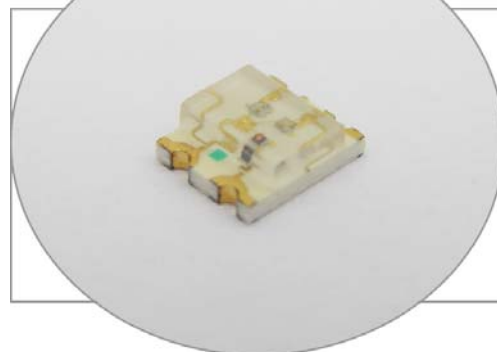

Bivar Surface Mount 1210 package RGB LED combines three chips in a single package. They are ideal for small scale applications where multiple signals need to be displayed. Wide variety of colors can be created by simply mixing the three chips in different combinations. Bivar offers water clear LED lens for high luminous intensity and wide viewing angles making them suitable for lighting and display applications. The SM1210 RGB LED is packaged in standard tape and reels for pick and place assemblies.

Part Number	Material	Emitted Color	Peak Wavelength λ_p (nm) TYP.	Lens Appearance	Luminous Intensity (mcd) TYP.	Viewing Angle
SM1210RGB	AlGaInP	RED	645	Water Clear	72	130°
	InGaN	BLUE	468		72	
	GaN	GREEN	523		285	

Outline Dimensions

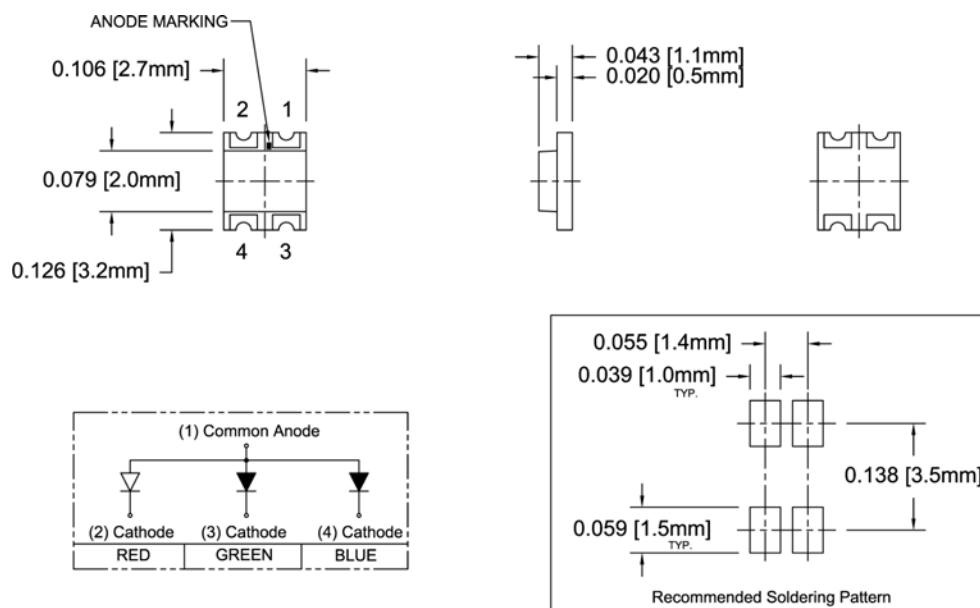

Outline Drawings Notes:

1. All dimensions are in inches [millimeters].
2. Standard tolerance: ± 0.010 " unless otherwise noted.



Bivar reserves the right to make changes at any time without notice.

SURFACE MOUNT LED RED/GREEN/BLUE, 1210 PACKAGE



Absolute Maximum Ratings

$T_A = 25^\circ\text{C}$ unless otherwise noted

Power Dissipation	Red - 78 mW Blue, Green - 84 mW
Forward Current (DC)	25 mA
Peak Forward Current ¹	100 mA
Reverse Voltage	5 V
Operating Temperature Range	-30 ~ +80°C
Storage Temperature Range	-40 ~ +85°C
Lead Soldering Temperature (3 mm from the base of the epoxy bulb) ²	260°C

Notes: 1. 10% Duty Cycle, Pulse Width \leq 0.1 msec. 2. Solder time less than 5 seconds at temperature extreme.

Electrical / Optical Characteristics

$T_A = 25^\circ\text{C}$ & $I_F = 20\text{ mA}$ unless otherwise noted

Part Number	Emitted color	Forward Voltage (V) ¹			Recommend Forward Current (mA)			Reverse Current (μA)	Dominant Wavelength (nm) ²			Luminous Intensity I_v (mcd)			Viewing Angle $2\theta_{1/2}$ (deg)
		MIN	TYP	MAX	MIN	TYP	MAX	MAX	MIN	TYP	MAX	MIN	TYP	MAX	TYP
SM1210RGB	RED	/	2.1	2.6	/	20	/	10	/	631	/	45	72	/	130
	BLUE	/	2.9	4.2	/	20	/	10	/	470	/	45	72	/	130
	GREEN	/	3.1	4.2	/	20	/	10	/	525	/	180	285	/	130

Notes: 1. Tolerance of forward voltage : $\pm 0.05\text{V}$. 2. Tolerance of dominant wavelength : $\pm 1.0\text{nm}$.

Bivar reserves the right to make changes at any time without notice.

SURFACE MOUNT LED RED/GREEN/BLUE, 1210 PACKAGE



Typical Electrical / Optical Characteristics

$T_A = 25^\circ\text{C}$ unless otherwise noted

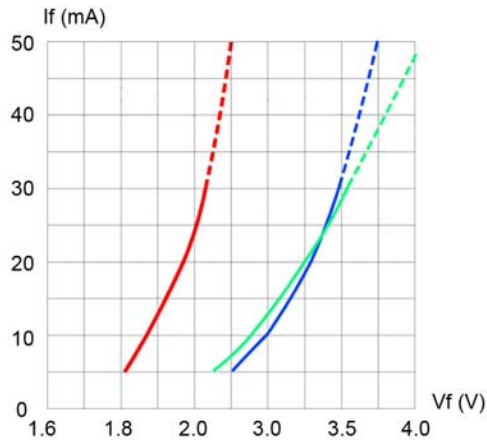

Fig. 1 Forward Current vs. Forward Voltage

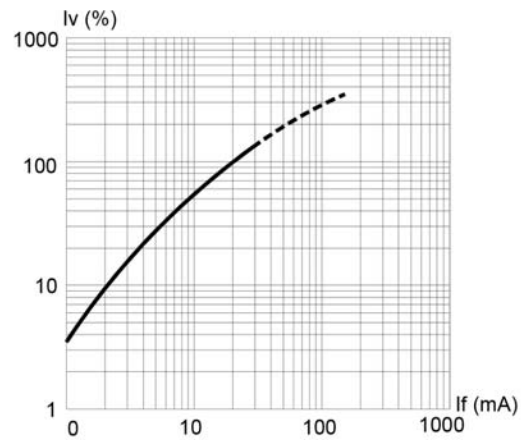

Fig. 2 Relative Luminous Intensity vs. Forward Current

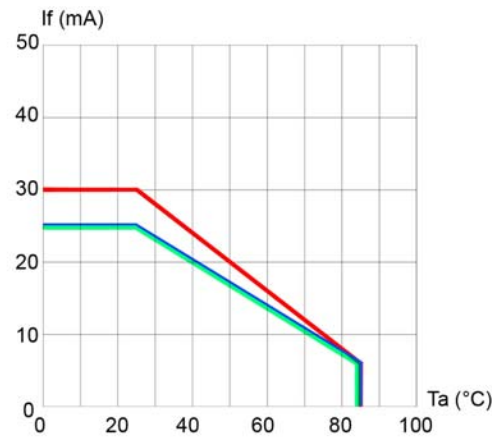

Fig. 3 Forward Current vs. Temperature

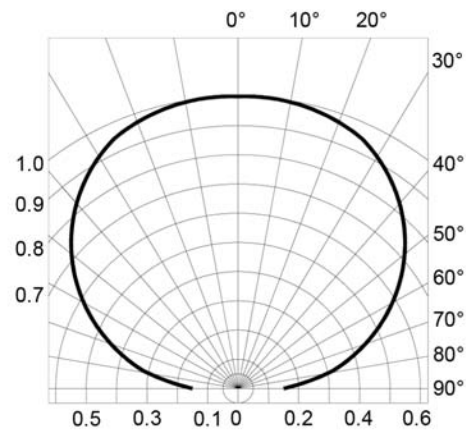

Fig. 4 Directivity Radiation Diagram

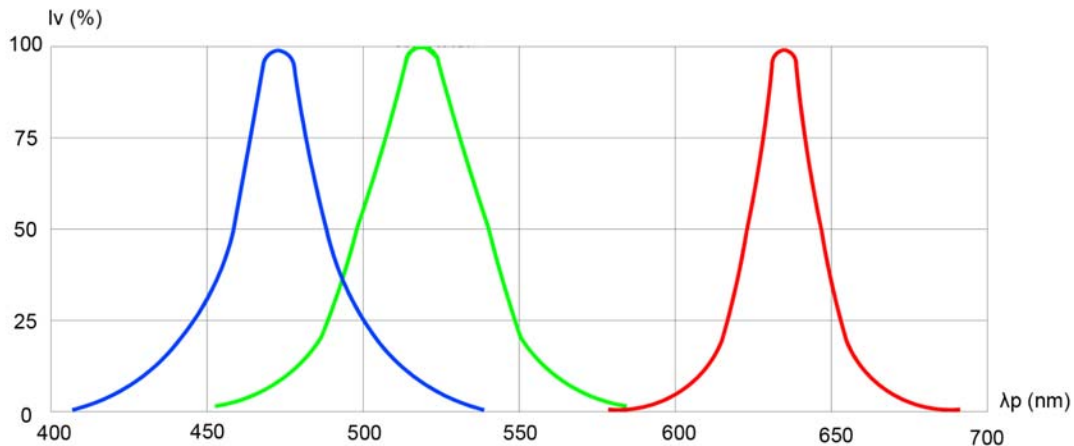

Fig. 5 Relative Luminous Intensity vs. Peak Wavelength

Bivar reserves the right to make changes at any time without notice.

SURFACE MOUNT LED RED/GREEN/BLUE, 1210 PACKAGE



Recommended Soldering Conditions

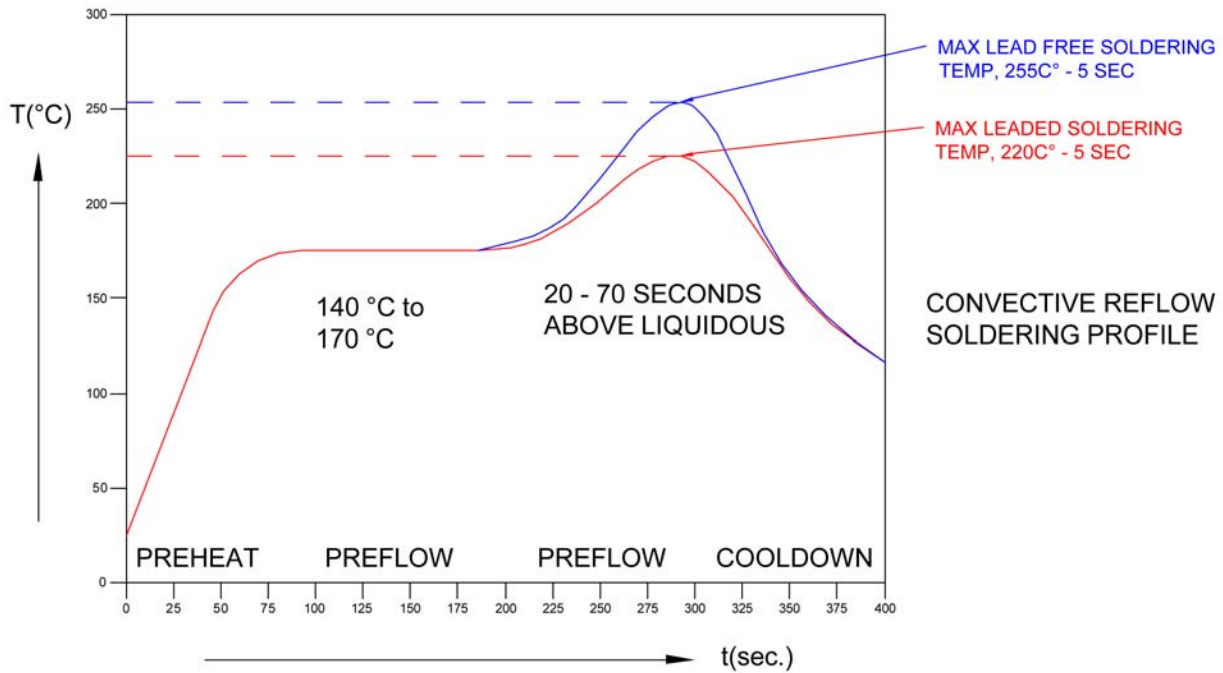

Tape and Reel Dimensions

Note: 3000 pcs/Reel

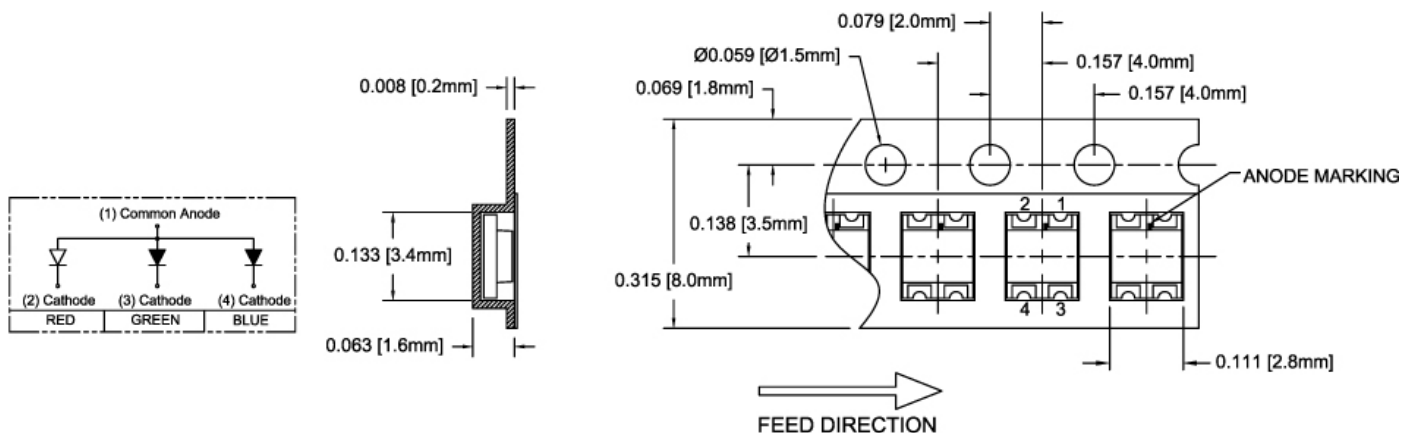

Outline Drawings Notes:

1. All dimensions are in inches [millimeters].
2. Standard tolerance: $\pm 0.010''$ unless otherwise noted.

Bivar reserves the right to make changes at any time without notice.

SURFACE MOUNT LED RED/GREEN/BLUE, 1210 PACKAGE



Outline Drawings Notes:

1. All dimensions are in inches [millimeters].
2. Standard tolerance unless otherwise noted: X.XXX ± 0.010"
X.X ± 0.1"

Packaging and Labeling Plan

Note: 1 Reel / Bag

Sealed ESD and Moisture Barrier Bag

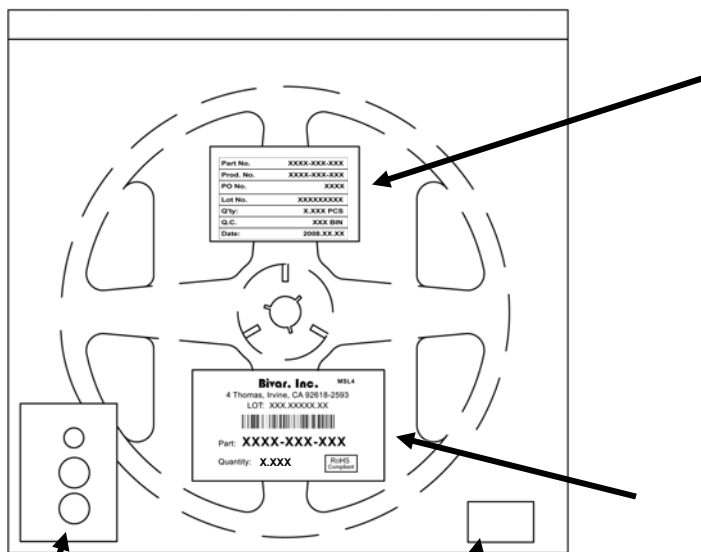

Humidity Indicator Card

Desiccant Card

Part No.	XXXX-XXX-XXX
Prod. No.	XXXX-XXX-XXX
PO No.	XXXX
Lot No.	XXXXXXXXXX
Q'ty:	X.XXX PCS
Q.C.	XXX BIN
Date:	2008.XX.XX

Internal Quality Control Label

Bivar, Inc. MSL4

4 Thomas, Irvine, CA 92618-2593
LOT: XXX.XXXXX.XX



Part: **XXXX-XXX-XXX**

Quantity: **X.XXX**

RoHS Compliant

Bivar Standard Packaging Label

Bivar reserves the right to make changes at any time without notice.

Mouser Electronics

Authorized Distributor

Click to View Pricing, Inventory, Delivery & Lifecycle Information:

[BIVAR:](#)

[SM1210RGB](#)