

N-channel 500 V, 0.019 Ω typ., 110 A, MDmesh™ II Power MOSFET in a Max247 package

Datasheet - production data

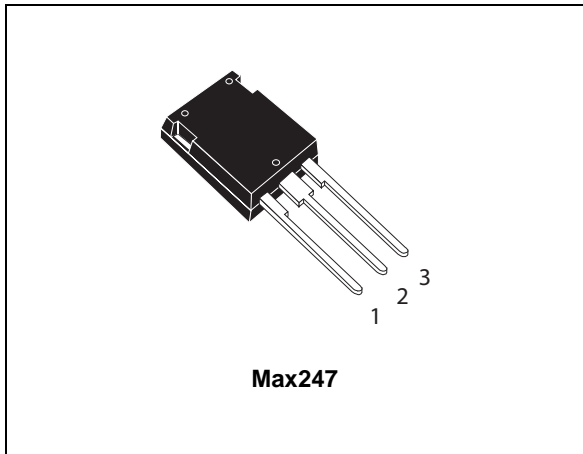
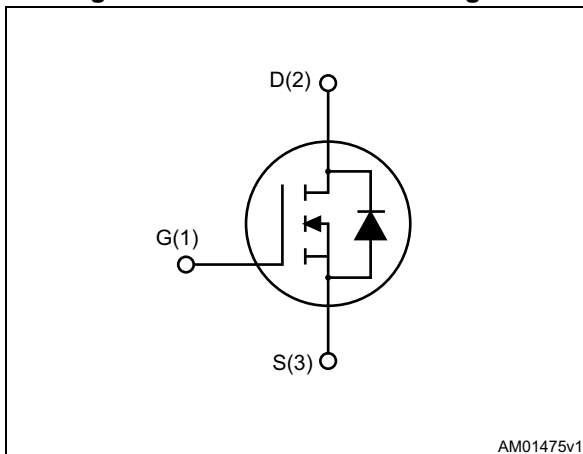

Figure 1. Internal schematic diagram



Features

Order code	V_{DSS} @ T_{jMAX}	$R_{DS(on)}$ max	I_D
STY105NM50N	550 V	< 0.022 Ω	110 A

- Max247 worldwide best $R_{DS(on)}$
- 100% avalanche tested
- Low input capacitance and gate charge
- Low gate input resistance

Applications

- Switching applications

Description

This device is an N-channel Power MOSFET developed using the second generation of MDmesh™ technology. This revolutionary Power MOSFET associates a vertical structure to the company's strip layout to yield one of the world's lowest on-resistance and gate charge. It is therefore suitable for the most demanding high efficiency converters.

Table 1. Device summary

Order code	Marking	Package	Packaging
STY105NM50N	105NM50N	Max247	Tube

Contents

1	Electrical ratings	3
2	Electrical characteristics	4
	2.1 Electrical characteristics (curves)	6
3	Test circuits	8
4	Package mechanical data	9
5	Revision history	12

1 Electrical ratings

Table 2. Absolute maximum ratings

Symbol	Parameter	Value	Unit
V_{GS}	Gate- source voltage	± 25	V
I_D	Drain current (continuous) at $T_C = 25\text{ }^\circ\text{C}$	110	A
I_D	Drain current (continuous) at $T_C = 100\text{ }^\circ\text{C}$	88	A
$I_{DM}^{(1)}$	Drain current (pulsed)	440	A
P_{TOT}	Total dissipation at $T_C = 25\text{ }^\circ\text{C}$	625	W
$dv/dt^{(2)}$	Peak diode recovery voltage slope	15	V/ns
T_{stg}	Storage temperature	- 55 to 150	$^\circ\text{C}$
T_j	Max. operating junction temperature		$^\circ\text{C}$

1. Pulse width limited by safe operating area.

2. $I_{SD} \leq 110\text{ A}$, $di/dt \leq 400\text{ A}/\mu\text{s}$, $V_{DS\text{ peak}} \leq V_{(BR)DSS}$, $V_{DD} = 80\% V_{(BR)DSS}$.

Table 3. Thermal data

Symbol	Parameter	Value	Unit
$R_{thj-case}$	Thermal resistance junction-case max	0.2	$^\circ\text{C}/\text{W}$
$R_{thj-amb}$	Thermal resistance junction-ambient max	30	$^\circ\text{C}/\text{W}$

Table 4. Avalanche characteristics

Symbol	Parameter	Value	Unit
I_{AR}	Avalanche current, repetitive or not repetitive (pulse width limited by T_{jmax})	17	A
E_{AS}	Single pulse avalanche energy (starting $T_j=25\text{ }^\circ\text{C}$, $I_D=I_{ar}$, $V_{DD}=50$)	809	mJ

2 Electrical characteristics

($T_C = 25\text{ °C}$ unless otherwise specified)

Table 5. On /off states

Symbol	Parameter	Test conditions	Min.	Typ.	Max.	Unit
$V_{(BR)DSS}$	Drain-source breakdown voltage ($V_{GS} = 0$)	$I_D = 1\text{ mA}$	500			V
I_{DSS}	Zero gate voltage drain current ($V_{GS} = 0$)	$V_{DS} = 500\text{ V}$ $V_{DS} = 500\text{ V}, T_C = 125\text{ °C}$			10 150	μA μA
I_{GSS}	Gate-body leakage current ($V_{DS} = 0$)	$V_{GS} = \pm 25\text{ V}$			± 100	nA
$V_{GS(th)}$	Gate threshold voltage	$V_{DS} = V_{GS}, I_D = 250\text{ }\mu\text{A}$	2	3	4	V
$R_{DS(on)}$	Static drain-source on-resistance	$V_{GS} = 10\text{ V}, I_D = 52\text{ A}$		0.019	0.022	Ω

Table 6. Dynamic

Symbol	Parameter	Test conditions	Min.	Typ.	Max.	Unit
C_{iss}	Input capacitance	$V_{DS} = 100\text{ V}, f = 1\text{ MHz},$ $V_{GS} = 0$	-	9600	-	pF
C_{oss}	Output capacitance		-	500	-	pF
C_{rss}	Reverse transfer capacitance		-	22	-	pF
$C_{oss(eq)}^{(1)}$	Equivalent output capacitance	$V_{DS} = 0\text{ to }400\text{ V}, V_{GS} = 0$	-	1675	-	pF
R_G	Intrinsic gate resistance	$f = 1\text{ MHz}$ open drain	-	1.3	-	Ω
Q_g	Total gate charge	$V_{DD} = 400\text{ V}, I_D = 110\text{ A},$ $V_{GS} = 10\text{ V}$ (see Figure 15)	-	326	-	nC
Q_{gs}	Gate-source charge		-	40	-	nC
Q_{gd}	Gate-drain charge		-	180	-	nC

1. $C_{oss eq.}^{(1)}$ is defined as a constant equivalent capacitance giving the same charging time as C_{oss} when V_{DS} increases from 0 to 80% V_{DS}

Table 7. Switching times

Symbol	Parameter	Test conditions	Min.	Typ.	Max.	Unit
$t_{d(on)}$	Turn-on delay time	$V_{DD} = 250\text{ V}$, $I_D = 55\text{ A}$, $R_G = 4.7\ \Omega$, $V_{GS} = 10\text{ V}$ (see Figure 16) (see Figure 19)	-	47	-	ns
t_r	Rise time		-	88	-	ns
$t_{d(off)}$	Turn-off delay time		-	353	-	ns
t_f	Fall time		-	70	-	ns

Table 8. Source drain diode

Symbol	Parameter	Test conditions	Min.	Typ.	Max.	Unit
I_{SD}	Source-drain current		-		110	A
$I_{SDM}^{(1)}$	Source-drain current (pulsed)				440	A
$V_{SD}^{(2)}$	Forward on voltage	$I_{SD} = 110\text{ A}$, $V_{GS} = 0$	-		1.6	V
t_{rr}	Reverse recovery time	$I_{SD} = 55\text{ A}$, $di/dt = 100\text{ A}/\mu\text{s}$ $V_{DD} = 100\text{ V}$ (see Figure 16)	-	552		ns
Q_{rr}	Reverse recovery charge		-	13.2		μC
I_{RRM}	Reverse recovery current		-	48		A
t_{rr}	Reverse recovery time	$I_{SD} = 55\text{ A}$, $di/dt = 100\text{ A}/\mu\text{s}$ $V_{DD} = 100\text{ V}$, $T_j = 150\text{ }^\circ\text{C}$ (see Figure 16)	-	672		ns
Q_{rr}	Reverse recovery charge		-	19.5		μC
I_{RRM}	Reverse recovery current		-	58		A

1. Pulse width limited by safe operating area.
2. Pulsed: pulse duration = 300 μs , duty cycle 1.5%

2.1 Electrical characteristics (curves)

Figure 2. Safe operating area

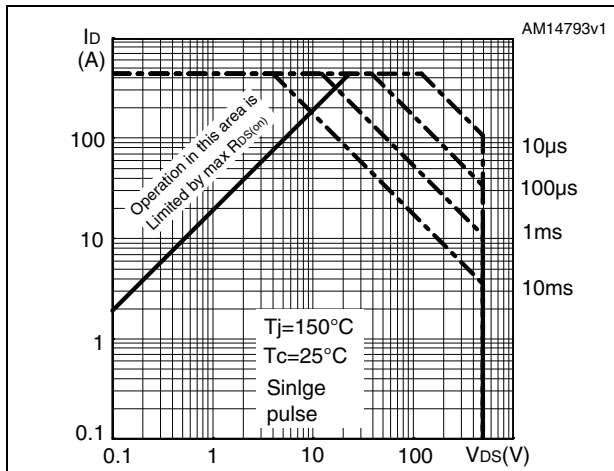

Figure 3. Thermal impedance

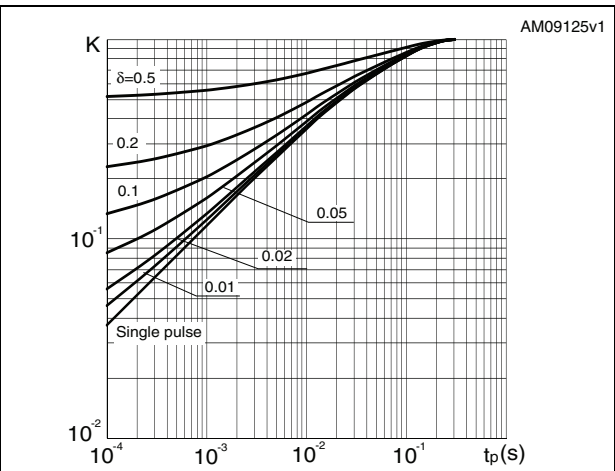

Figure 4. Output characteristics

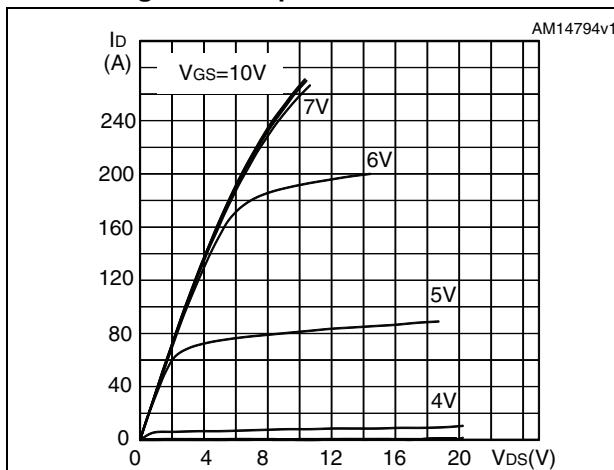

Figure 5. Transfer characteristics

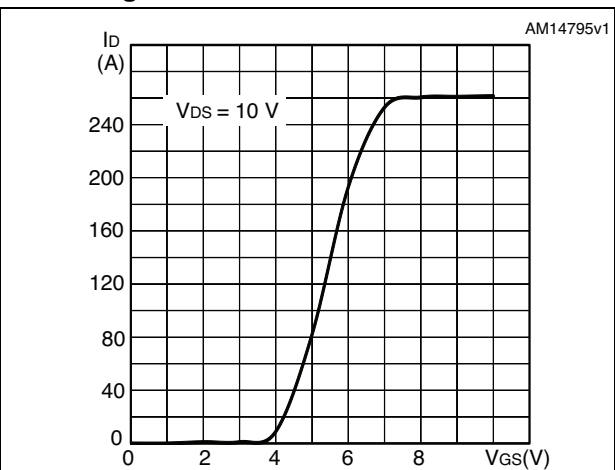

Figure 6. Normalized BV_{DSS} vs temperature

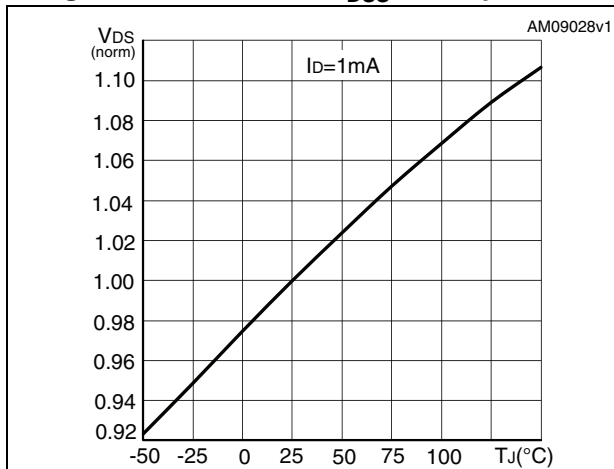

Figure 7. Static drain-source on-resistance

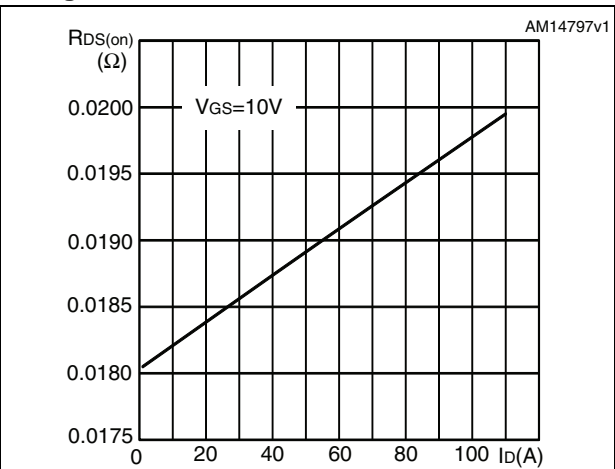

Figure 8. Gate charge vs gate-source voltage

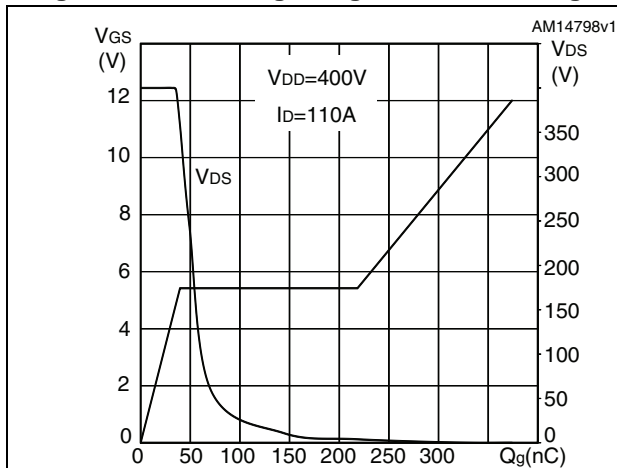

Figure 9. Capacitance variations

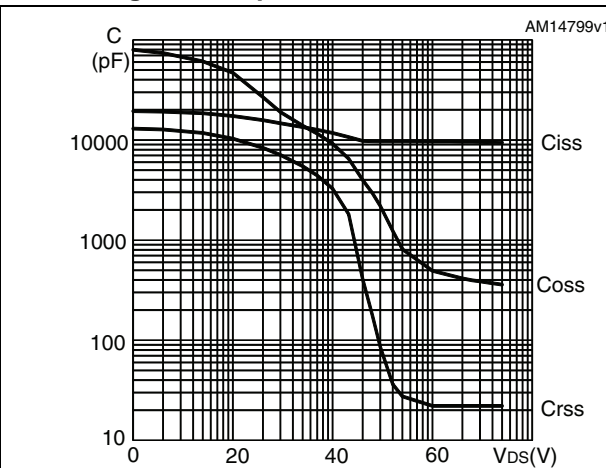

Figure 10. Normalized gate threshold voltage vs temperature

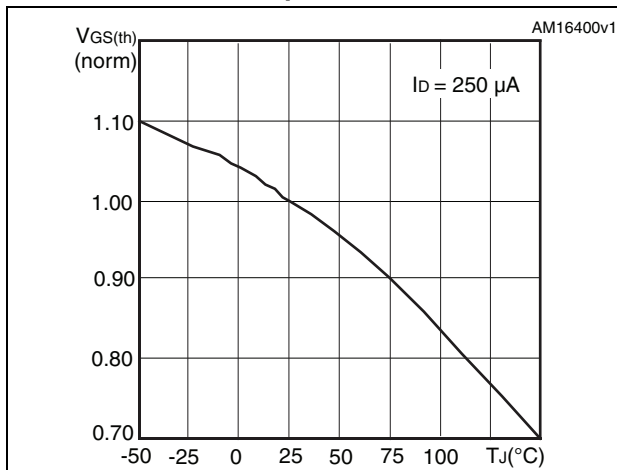

Figure 11. Normalized on-resistance vs temperature

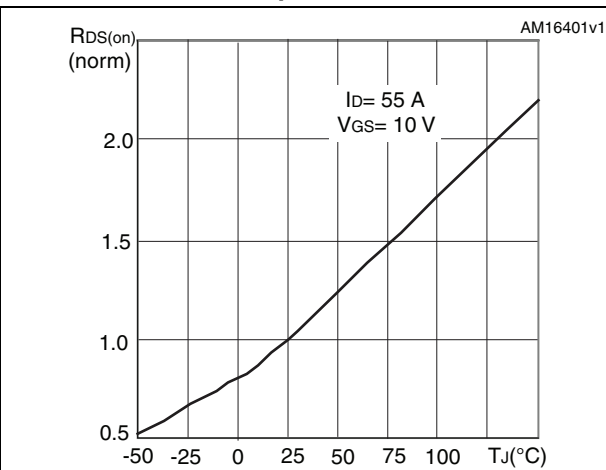

Figure 12. Source-drain diode forward vs temperature

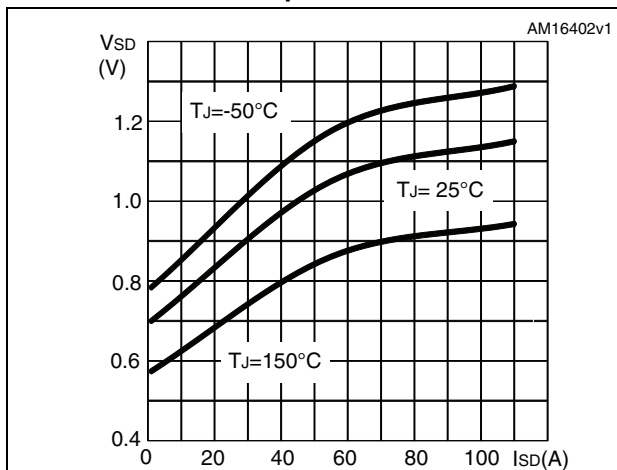
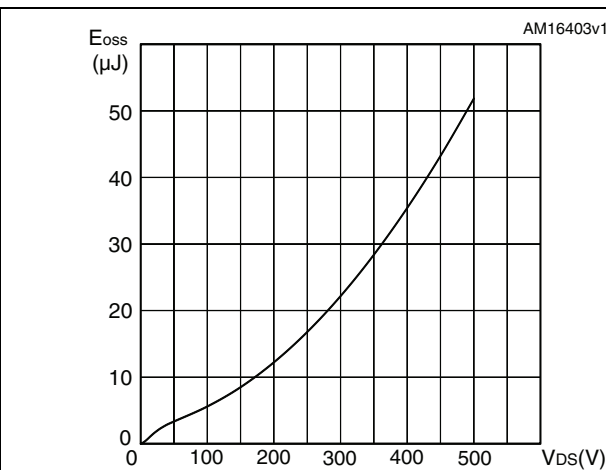

Figure 13. Output capacitance stored energy



3 Test circuits

Figure 14. Switching times test circuit for resistive load



AM01468v1

Figure 15. Gate charge test circuit



AM01469v1

Figure 16. Test circuit for inductive load switching and diode recovery times



AM01470v1

Figure 17. Unclamped inductive load test circuit



AM01471v1

Figure 18. Unclamped inductive waveform

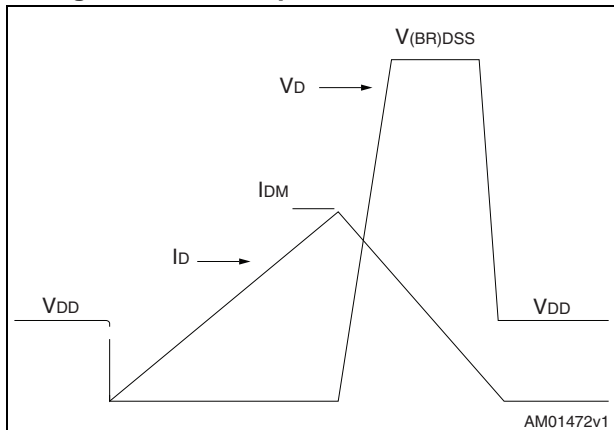

AM01472v1

Figure 19. Switching time waveform

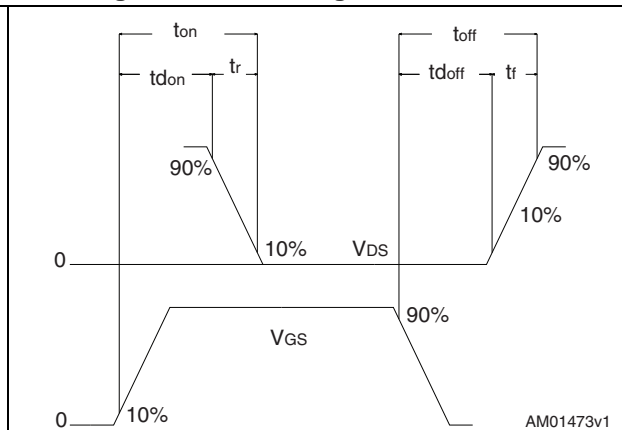

AM01473v1

4 Package mechanical data

In order to meet environmental requirements, ST offers these devices in different grades of ECOPACK[®] packages, depending on their level of environmental compliance. ECOPACK[®] specifications, grade definitions and product status are available at: www.st.com. ECOPACK[®] is an ST trademark.

Table 9. Max247 mechanical data

Dim.	mm		
	Min.	Typ.	Max.
A	4.70		5.30
A1	2.20		2.60
b	1.00		1.40
b1	2.00		2.40
b2	3.00		3.40
c	0.40		0.80
D	19.70		20.30
e	5.35		5.55
E	15.30		15.90
L	14.20		15.20
L1	3.70		4.30

Figure 20. Max247 drawing

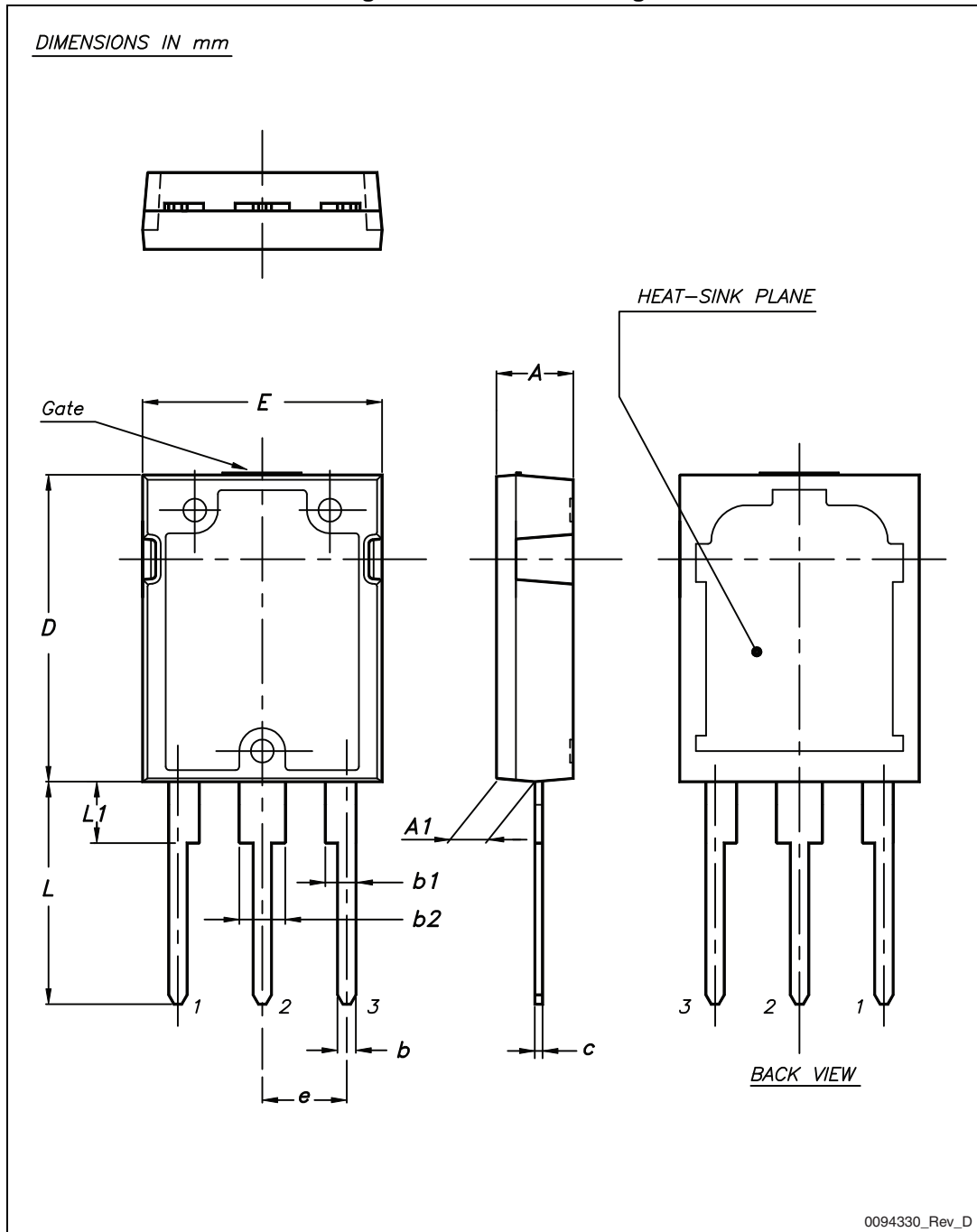

5 Revision history

Table 10. Document revision history

Date	Revision	Changes
14-Sep-2011	1	First release.
15-Nov-2012	2	Document status promoted from preliminary to production data. Added Section 2.1: Electrical characteristics (curves) . Minor text changes.
29-Jul-2013	3	– Updated $V_{(BR)DSS}$ in Table 5: On /off states . – Updated figures in Section 3: Test circuits .

Please Read Carefully:

Information in this document is provided solely in connection with ST products. STMicroelectronics NV and its subsidiaries ("ST") reserve the right to make changes, corrections, modifications or improvements, to this document, and the products and services described herein at any time, without notice.

All ST products are sold pursuant to ST's terms and conditions of sale.

Purchasers are solely responsible for the choice, selection and use of the ST products and services described herein, and ST assumes no liability whatsoever relating to the choice, selection or use of the ST products and services described herein.

No license, express or implied, by estoppel or otherwise, to any intellectual property rights is granted under this document. If any part of this document refers to any third party products or services it shall not be deemed a license grant by ST for the use of such third party products or services, or any intellectual property contained therein or considered as a warranty covering the use in any manner whatsoever of such third party products or services or any intellectual property contained therein.

UNLESS OTHERWISE SET FORTH IN ST'S TERMS AND CONDITIONS OF SALE ST DISCLAIMS ANY EXPRESS OR IMPLIED WARRANTY WITH RESPECT TO THE USE AND/OR SALE OF ST PRODUCTS INCLUDING WITHOUT LIMITATION IMPLIED WARRANTIES OF MERCHANTABILITY, FITNESS FOR A PARTICULAR PURPOSE (AND THEIR EQUIVALENTS UNDER THE LAWS OF ANY JURISDICTION), OR INFRINGEMENT OF ANY PATENT, COPYRIGHT OR OTHER INTELLECTUAL PROPERTY RIGHT.

ST PRODUCTS ARE NOT AUTHORIZED FOR USE IN WEAPONS. NOR ARE ST PRODUCTS DESIGNED OR AUTHORIZED FOR USE IN: (A) SAFETY CRITICAL APPLICATIONS SUCH AS LIFE SUPPORTING, ACTIVE IMPLANTED DEVICES OR SYSTEMS WITH PRODUCT FUNCTIONAL SAFETY REQUIREMENTS; (B) AERONAUTIC APPLICATIONS; (C) AUTOMOTIVE APPLICATIONS OR ENVIRONMENTS, AND/OR (D) AEROSPACE APPLICATIONS OR ENVIRONMENTS. WHERE ST PRODUCTS ARE NOT DESIGNED FOR SUCH USE, THE PURCHASER SHALL USE PRODUCTS AT PURCHASER'S SOLE RISK, EVEN IF ST HAS BEEN INFORMED IN WRITING OF SUCH USAGE, UNLESS A PRODUCT IS EXPRESSLY DESIGNATED BY ST AS BEING INTENDED FOR "AUTOMOTIVE, AUTOMOTIVE SAFETY OR MEDICAL" INDUSTRY DOMAINS ACCORDING TO ST PRODUCT DESIGN SPECIFICATIONS. PRODUCTS FORMALLY ESCC, QML OR JAN QUALIFIED ARE DEEMED SUITABLE FOR USE IN AEROSPACE BY THE CORRESPONDING GOVERNMENTAL AGENCY.

Resale of ST products with provisions different from the statements and/or technical features set forth in this document shall immediately void any warranty granted by ST for the ST product or service described herein and shall not create or extend in any manner whatsoever, any liability of ST.

ST and the ST logo are trademarks or registered trademarks of ST in various countries.

Information in this document supersedes and replaces all information previously supplied.

The ST logo is a registered trademark of STMicroelectronics. All other names are the property of their respective owners.

© 2013 STMicroelectronics - All rights reserved

STMicroelectronics group of companies

Australia - Belgium - Brazil - Canada - China - Czech Republic - Finland - France - Germany - Hong Kong - India - Israel - Italy - Japan - Malaysia - Malta - Morocco - Philippines - Singapore - Spain - Sweden - Switzerland - United Kingdom - United States of America

www.st.com



Mouser Electronics

Authorized Distributor

Click to View Pricing, Inventory, Delivery & Lifecycle Information:

[STMicroelectronics:](#)

[STY105NM50N](#)