

Features

Switching Regulator

- Non-isolated
- Adjustable output voltage
- 1-2AMP adjustable positive step down integrated switching regulator
- Internal short circuit protection
- ON/OFF control (ground off)
- Efficiency up to 97%
- Positive to negative converter



R-6xxxP_D

**1-2 Amp
SIP12
Vertical &
Horizontal
Single Output**



Description

The R-6xxx series is a high performance 1.5V to 15V (18V), 1.1 Amp to 2Amp, 12-Pin SIP (single in-line package) switching regulator. The Synchronous rectification yields excellent efficiencies up to 97%. Short circuit protection reduces the short circuit input current to under 50mA.

Selection Guide

Part Number	Input Voltage Range [VDC]	Output Voltage [VDC]	Vout Adjust Range ⁽¹⁾ [VDC]	Output Current [A]	Efficiency @ min Vin [%]	Efficiency @ max. Vin [%]	Max. Capacitive Load ⁽²⁾ [μF]
R-611.8x	9 - 32	1.8	1.5 - 3.6	1	79	67	200/6800
R-612.5x	9 - 32	2.5	1.5 - 4.5	1	84	74	200/6800
R-613.3x	9 - 32	3.3	1.8 - 6	1	88	79	200/6800
R-615.0x	9 - 32	5	1.8 - 9	1	92	84	200/6800
R-619.0x	11 - 32	9	3.3 - 15	1	96	90	200/6800
R-6112x	14 - 32	12	3.3 - 15	1	97	92	200/6800
R-621.8x	9 - 32	1.8	1.5 - 3.6	2	76	68	200/6800
R-622.5x	9 - 32	2.5	1.5 - 4.5	2	81	74	200/6800
R-623.3x	9 - 32	3.3	1.8 - 6	2	86	80	200/6800
R-625.0x	9 - 32	5	1.8 - 9	2	90	85	200/6800
R-629.0x	11 - 32	9	3.3 - 15	2	95	91	200/6800
R-6212x	14 - 32	12	3.3 - 15	2	96	93	200/6800

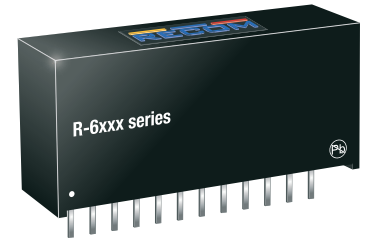

Notes:

- Note1: $V_{in} - V_{out} \geq 1.5V$ if adjust function is used
 Note2: please refer to basic characteristics on page I-2

IEC/EN60950-1 certified

Model Numbering

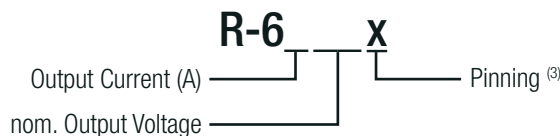

Notes:

- Note3: x can be „P“ = vertical through hole
 x can be „D“ = bent for horizontal through hole mounting

Ordering Examples:

- R-612.5P $I_{out} = 1000mA$ nom. $V_{out} = 2.5VDC$ P= vertical through hole
 R-623.3D $I_{out} = 2000mA$ nom. $V_{out} = 3.3VDC$ D= bent for horizontal through hole mounting

Specifications (refer to standard application circuit, Ta= 25°C)

BASIC CHARACTERISTICS

Parameter	Condition	Min.	Typ.	Max.
Quiescent Current	min. Vin to max.		6mA	10mA
Internal Power Dissipation	ta<60°C			1.0W
Output Current Limit		4A	4.5A	5A
Minimum Load		10%		
ON/OFF CTRL ⁽⁴⁾	DC-DC ON DC-DC OFF	Open or high (Power ON), 2V min. / 10V max. Low (Power OFF) 0.8V max.		
Input Current of CTRL Pin	DC-DC OFF		100µA	
Internal Operating Frequency		200kHz	250kHz	300kHz
Output Ripple and Noise	R-61xxx R-62xxx		40mVp-p 40mVp-p	100mVp-p 120mVp-p
Maximum Capacitive Load	normal start-up time, no external diodes			200µF
	<1 second start-up time + diode protection circuit			6800µF

Notes:

Note4: ON/OFF pin driven by TTL (logic gate), open-collector bipolar transistor or open-drain MOSFET

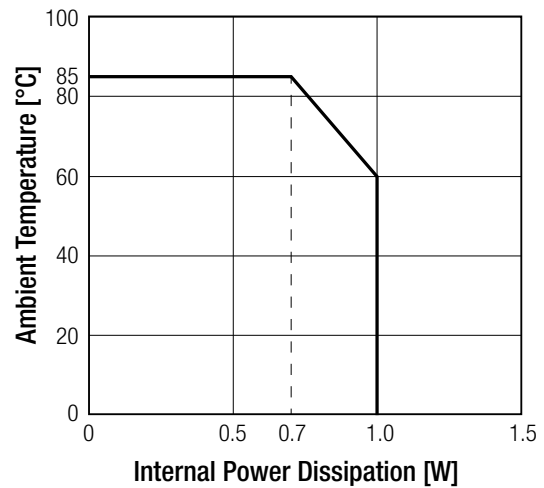
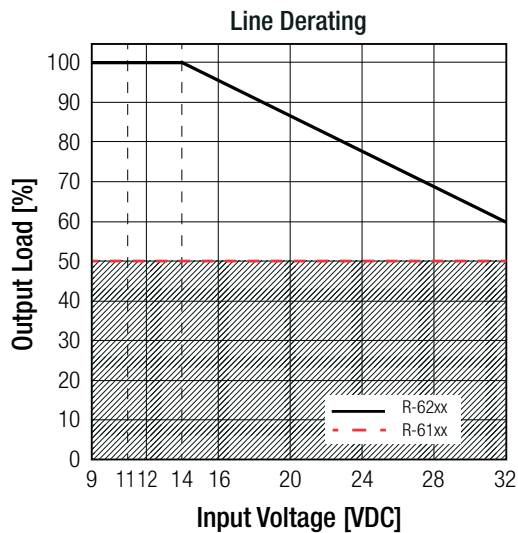

How to calculate the max output current

The internal power dissipation (P_D) follows the equation:

$$P_D = I_{out} \times V_{out} \times (1 - \text{Eff}_{\max Vin}) \quad I_{out} = \frac{P_D}{V_{out} \times (1 - \text{Eff}_{\max Vin})}$$

Example: R-6212P

Calculation 1:

V_{in} = 32V

V_{out} = 12V

Eff_{max Vin} = 93%

P_D = 1W

T_{Ambient} = 60°C

$$I_{out} = \frac{1W}{12V \times (1 - 0.93)} = 1.19A$$

Calculation 2:

V_{in} = 14V

V_{out} = 12V

Eff_{max Vin} = 96%

P_D = 1W

T_{Ambient} = 60°C

$$I_{out} = \frac{1W}{12V \times (1 - 0.96)} = 2.08A$$

continued on next page

Specifications (refer to standard application circuit, Ta= 25°C)

Efficiency vs. Load

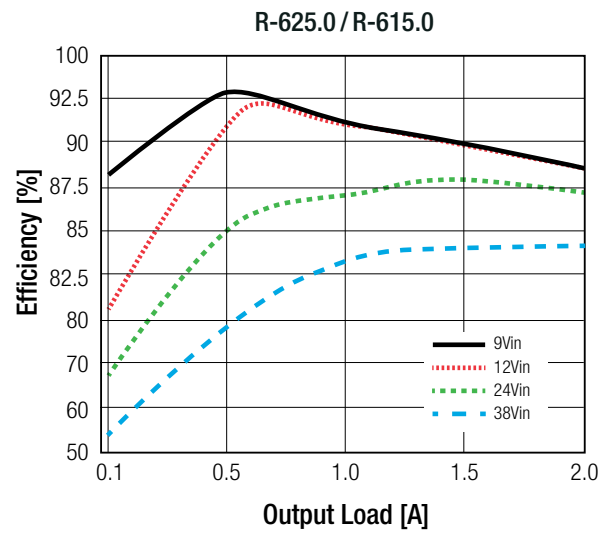
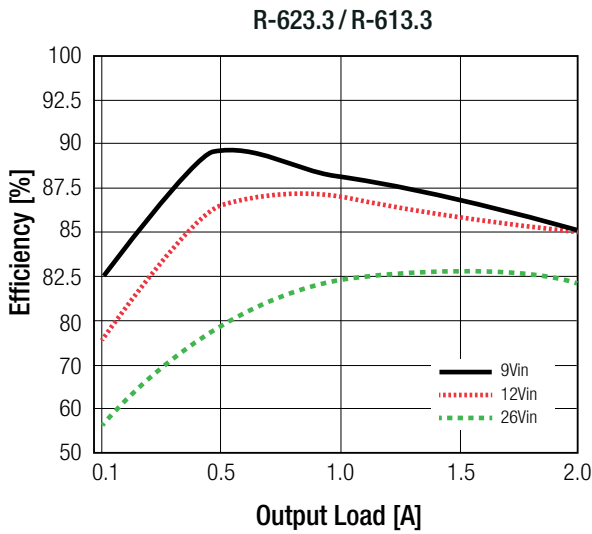

Ripple vs. Output Current

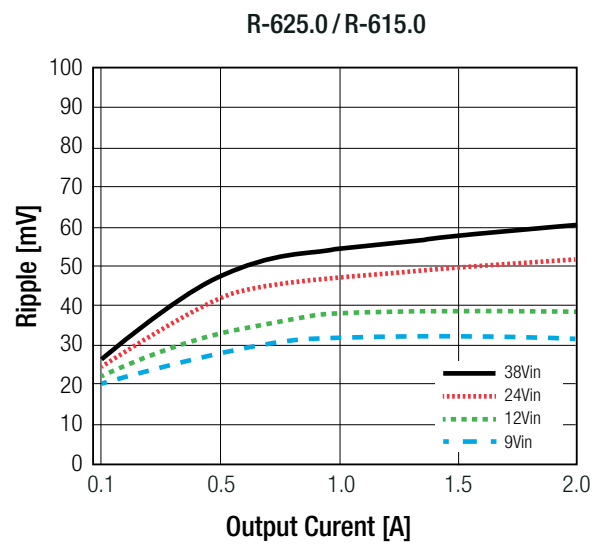
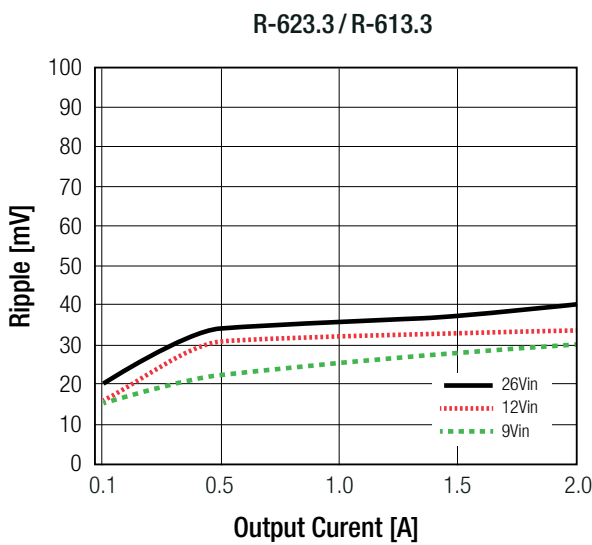

Trim Tables or Calculation

2ADC	R-611.8P/D	R-612.5P/D	R-613.3P/D	R-615.0P/D	R-619.0P/D	R-6112P/D
3ADC	R-621.8P/D	R-622.5P/D	R-623.3P/D	R-625.0P/D	R-629.0P/D	R-6212P/D

Vout nom.	1.8VDC		2.5VDC		3.3VDC		5.0VDC		9.0VDC		12VDC	
Vout adj.	R1	R2	R1	R2	R1	R2	R1	R2	R1	R2	R1	R2
1.5	13.6kΩ		3.3kΩ									
1.8			8.2kΩ		3.1kΩ		820kΩ					
2.0		10kΩ	15kΩ		5.1kΩ		1.5kΩ					
2.5		5.1kΩ			13kΩ		3.6kΩ					
3.0		2.5kΩ		10kΩ	51kΩ		7.0kΩ					

continued on next page

Specifications (refer to standard application circuit, Ta= 25°C)

Trim Tables or Calculation

2ADC	R-611.8P/D	R-612.5P/D	R-613.3P/D	R-615.0P/D	R-619.0P/D	R-6112P/D						
3ADC	R-621.8P/D	R-622.5P/D	R-623.3P/D	R-625.0P/D	R-629.0P/D	R-6212P/D						
Vout nom.	1.8VDC		2.5VDC		3.3VDC		5.0VDC		9.0VDC		12VDC	
Vout adj.	R1	R2	R1	R2	R1	R2	R1	R2	R1	R2	R1	R2
3.3		1.7kΩ		5.9kΩ			9.7kΩ		0Ω		0Ω	
3.6		1.2kΩ		3.9kΩ		18kΩ	14kΩ		1.5kΩ		560Ω	
3.9				2.8kΩ		9.1kΩ	20kΩ		3.3kΩ		1.2kΩ	
4.5				1.6kΩ		3.9kΩ	60kΩ		7.5kΩ		2.1kΩ	
5.0						2.4kΩ			11kΩ		4.0kΩ	
5.1						2.2kΩ		60kΩ	12kΩ		4.3kΩ	
5.5						1.6kΩ		15kΩ	17kΩ		5.6kΩ	
6.0						1.1kΩ		7.2kΩ	24kΩ		7.5kΩ	
7.0								2.8kΩ	51kΩ		12kΩ	
8.0								1.5kΩ	130kΩ		19kΩ	
9.0								880Ω			31kΩ	
10								450Ω		36kΩ	55kΩ	
11								180Ω		15kΩ	125kΩ	
12										8.2kΩ		
13										4.7kΩ		11kΩ
14										2.7kΩ		4.0kΩ
15										1.3kΩ		1.6kΩ

REGULATIONS

Parameter	Condition		Value
Output Accuracy			±1.0% typ. / ±2.0% max.
Line Regulation	low line to high line, full load		±0.5% typ.
Load Regulation ⁽⁵⁾	10% to 100%, full load	R-61xxx R-62xxx	±0.5% max. ±1.0% max.
Transient Response ⁽⁶⁾	50% load step change Vout over / undershoot		100µs typ. / 200µs max. 5% typ.

Notes:

- Note5: Operation below 10% load will not harm the converter, but specifications may not be met
- Note6: Requires a 100µF electrolytic or tantalum output capacitor for proper operation in all applications (the capacitor has to be placed as close as possible to the output pins)

PROTECTIONS

Parameter	Condition	Value
Short Circuit Protection (SCP)		continuous, automatic recovery
Short Circuit Input Current	Vin > 12VDC	20mA typ. / 100mA max.

continued on next page

Specifications (refer to standard application circuit, Ta= 25°C)

Optional Diode Protection Circuit

Add a blocking diode to Vout if current can flow backwards into the output, as this can damage the converter when it is powered down. Protection diodes are required for high capacitive loads.

The diode can either be fitted across the device, if the source is low impedance or fitted in series with the output (recommended).

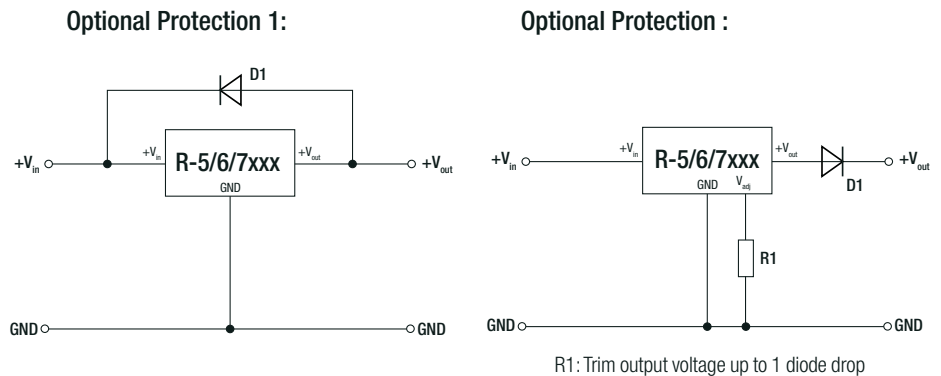

ENVIRONMENTAL			
Parameter	Condition		Value
Operating Temperature Range	without derating @ natural convection 0.1m/s		-40°C to +85°C
Maximum Case Temperature			+110°C
Thermal Impedance	@ natural convection 0.1m/s		25°C/W
Operating Humidity	non-condensing		95% RH max.
Operating Altitude			2000m
Pollution Degree			PD2
MTBF	according to MIL-HDBK 217F, G.B.	+25°C +71°C	563 x 10 ³ hours 117 x 10 ³ hours

SAFETY AND CERTIFICATIONS		
Certificate Type (Safety)	Report / File Number	Standard
Information Technology Equipment, General Requirements for Safety	1605077-12	IEC60950-1:2005, 2nd Edition + AM2:2013 EN60950-1:2006 + AM2:2013
EAC	RU-AT.49.09571	TP TC 004/2011
RoHS 2+		RoHS-2011/65/EU + AM-2015/863

DIMENSION AND PHYSICAL CHARACTERISTICS		
Parameter	Type	Value
Material	case potting	non-conductive black plastic, (UL94 V-0) epoxy, (UL94 V-0)
Dimension (LxWxH)		32.2 x 9.1 x 15.0mm
Weight		9g typ.

continue on next page

Specifications (refer to standard application circuit, Ta= 25°C)

Dimension Drawing (mm)

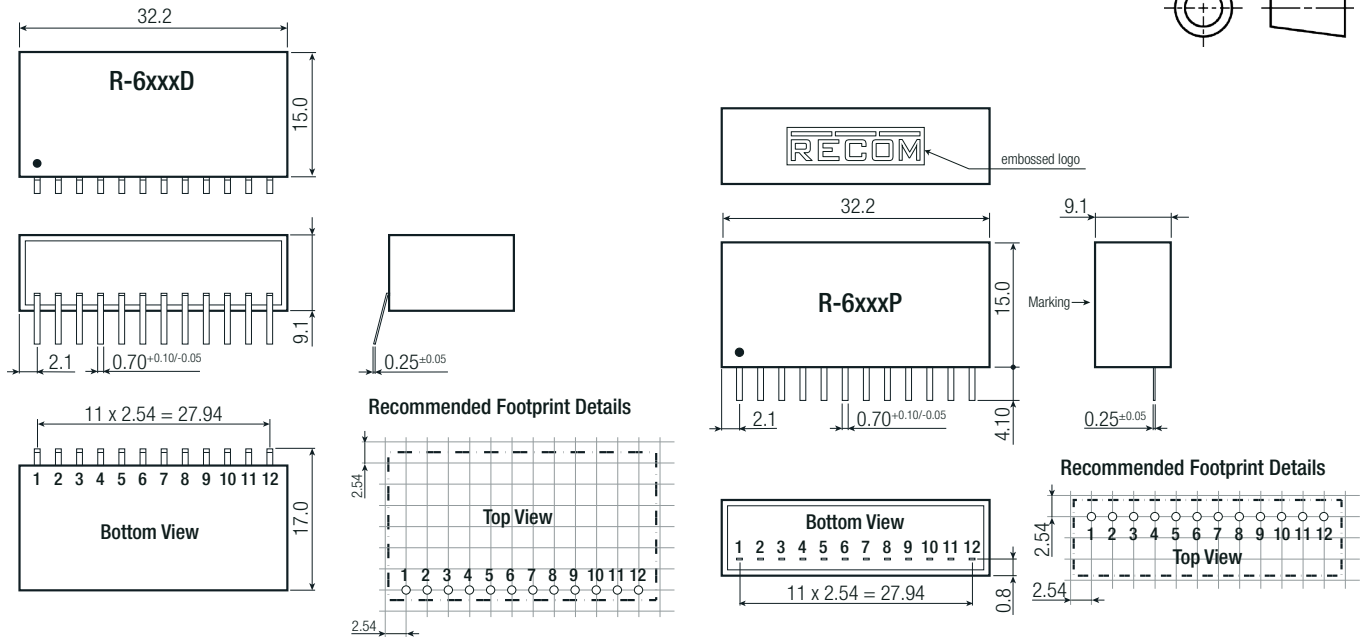

Pin Connections

Pin #	Single	Description
1	ON/OFF	Input pin: Active low (less than 0.8V) to disable the device
2,3,4	V _{in}	Power Input
5, 6, 7, 8	GND	Input and Output ground (common)
9, 10, 11	V _{out}	Power output
12	V _{adj}	With external resistors R1, R2 to selected output voltage

Tolerance: xx.x= ±0.5mm
xx.xx= ±0.25mm

INSTALLATION AND APPLICATION

Standard Application Circuit

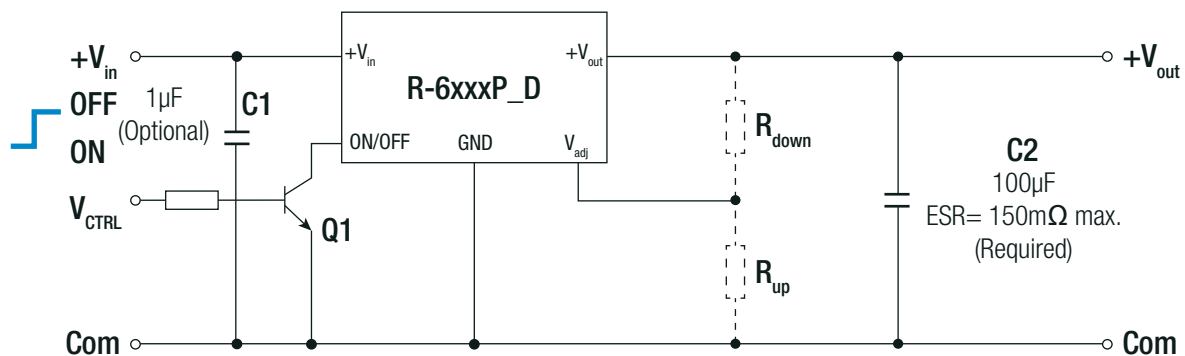

Add blocking diode to V_{out} if current can flow backwards into the output, as this can damage the converter.
(Please refer to "Optional Diode Protection Circuit" on page I-5)

continued on next page

Specifications (refer to standard application circuit, Ta= 25°C)

Positive to Negative Converter

Selection Guide (Positive to Negative)

Part Number	Input Voltage Range [VDC]	Output Voltage [VDC]	Vout Adjust Range ⁽¹⁾ [VDC]	Output Current [A]	Efficiency		Max. Capacitive Load ⁽⁷⁾	
					@ min Vin [%]	@ max. Vin [%]	C1	C2
R-621.8	9 - 28	-1.8	-1.5~ -3.6	-1	72	65	10µF/50V	100µF/6.3V
R-622.5	9 - 28	-2.5	-1.5~ -4.5	-1	76	72	10µF/50V	100µF/6.3V
R-623.3	9 - 28	-3.3	-1.8~ -6	-1	79	76	10µF/50V	100µF/10V
R-625.0	9 - 28	-5	-1.8~ -9	-1	81	80	10µF/50V	100µF/10V
R-629.0	11 - 26	-9	-3.3~ -15	-0.8	84	85	10µF/50V	100µF/25V
R-6212	11 - 26	-12	-3.3~ -15	-0.6	86	88	10µF/50V	100µF/25V

Notes:

Note7: Maximum capacitive load including C2 is 220µF

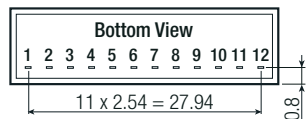
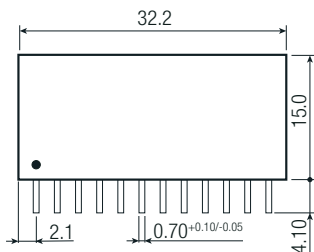
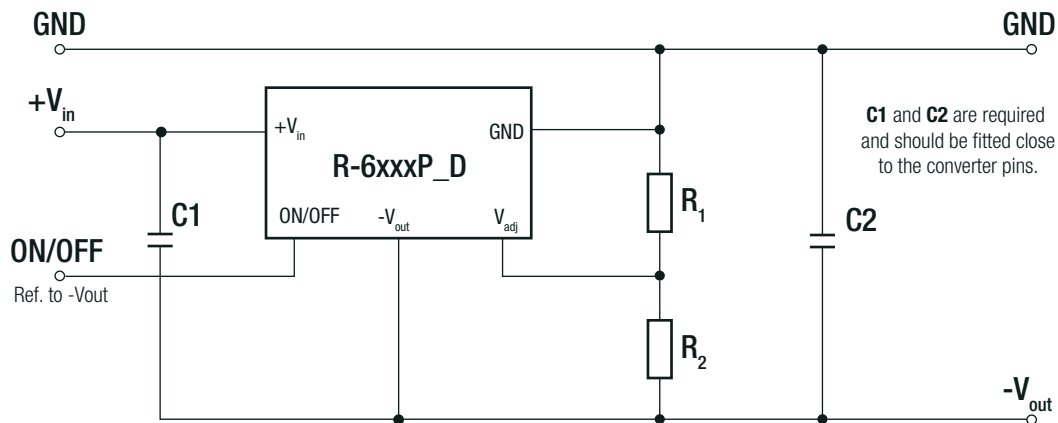

Pin Connections

Pin #	Negative Out	Positive Out
1	ON/OFF	ON/OFF
2,3,4	+Vin	+Vin
5, 6, 7, 8	-Vout	GND
9, 10, 11	GND	+Vout
12	-Vadj	+Vadj

PACKAGING INFORMATION

Parameter	Type	Value
Packaging Dimensions (LxWxH)	R-6xxxD	520.0 x 20.0 x 19.0mm
	R-6xxxP	530.0 x 23.0 x 19.0mm
Packaging Quantity	tube	15pcs
Storage Temperature Range		-40°C to +125°C

The product information and specifications may be subject to changes even without prior written notice. The product has been designed for various applications; its suitability lies in the responsibility of each customer. The products are not authorized for use in safety-critical applications without RECOM's explicit written consent. A safety-critical application is an application where a failure may reasonably be expected to endanger or cause loss of life, inflict bodily harm or damage property. The applicant shall indemnify and hold harmless RECOM, its affiliated companies and its representatives against any damage claims in connection with the unauthorized use of RECOM products in such safety-critical applications.

Mouser Electronics

Authorized Distributor

Click to View Pricing, Inventory, Delivery & Lifecycle Information:

RECOM:

[R-611.8D](#) [R-611.8P](#) [R-6112D](#) [R-6112P](#) [R-612.5D](#) [R-612.5P](#) [R-613.3D](#) [R-613.3P](#) [R-615.0D](#) [R-615.0P](#) [R-619.0D](#)
[R-619.0P](#) [R-621.8D](#) [R-621.8P](#) [R-6212D](#) [R-6212P](#) [R-622.5D](#) [R-622.5P](#) [R-623.3D](#) [R-623.3P](#) [R-625.0D](#) [R-625.0P](#)
[R-629.0D](#) [R-629.0P](#)