

ST repetitive voltage suppressor

Datasheet - production data

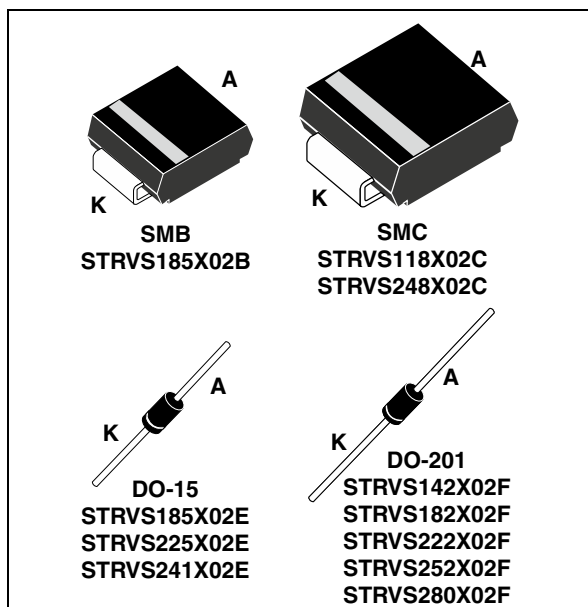

Applications

- MOSFET protection
- IGBT protection
- Auxiliary power supply

Description

The STRVSX series is a TVS family created to provide simple and effective solutions for designers working on circuits that require protection from repetitive overvoltage.

The STRVSX series is highly reliable and suits applications where the surge frequency makes the protected device temperature increase, for example, MOSFET protection in fly back configuration.

Additional support for designers using these devices is available in the STMicroelectronics application note AN4209: "Design methodology for repetitive voltage suppressors (RVS) in repetitive mode: STRVS".

Features

- Clamping voltage characteristics defined at 25 °C, 85 °C and 125 °C
- Stand-off voltage range: from 85 V to 188 V
- Low leakage current: 0.2 μ A at 25 °C
- Maximum operating junction temperatures:
 - SMB and SMC: 150 °C
 - DO-15 and DO-201: 175 °C

Complies with the following standards:

- IEC 61000-4-2 level 4
 - \pm 15 kV (air discharge)
 - \pm 8 kV (contact discharge)
- MIL-STD-883, method 3015, class 3B:
 - 25 kV HBM (human body model)
- MIL-STD-750, method 2026 solderability
- EIA STD RS-481 and IEC 60286-3 packing (surface mount packages)

Table 1. Device summary

| Order codes | Clamping voltage $I_{PP} = 2 \text{ A}$ (125 °C) | Package |
|--------------|---|---------|
| STRVS118X02C | 118 V | SMC |
| STRVS142X02F | 142 V | DO-201 |
| STRVS182X02F | 182 V | DO-201 |
| STRVS185X02B | 185 V | SMB |
| STRVS185X02E | 185 V | DO-15 |
| STRVS222X02F | 222 V | DO-201 |
| STRVS225X02E | 225 V | DO-15 |
| STRVS241X02E | 241 V | DO-15 |
| STRVS248X02C | 248 V | SMC |
| STRVS252X02F | 252 V | DO-201 |
| STRVS280X02F | 280 V | DO-201 |

1 Characteristics

Table 2. Absolute maximum ratings ($T_{amb} = 25\text{ }^{\circ}\text{C}$)

| Symbol | Parameter | Value | Unit |
|-----------|---|------------|--------------------|
| T_j | Operating junction temperature range (SMB and SMC) | -55 to 150 | $^{\circ}\text{C}$ |
| | Operating junction temperature range (DO-15 and DO-201) | -55 to 175 | $^{\circ}\text{C}$ |
| T_{stg} | Storage temperature range (SMB and SMC) | -65 to 150 | $^{\circ}\text{C}$ |
| | Storage temperature range (DO-15 and DO-201) | -65 to 175 | $^{\circ}\text{C}$ |
| T_L | Maximum lead temperature for soldering during 10 s (SMB and SMC) | 260 | $^{\circ}\text{C}$ |
| | Maximum lead temperature for soldering during 10 s at 5 mm from case (DO-15 and DO-201) | 260 | $^{\circ}\text{C}$ |

Table 3. Thermal resistances

| Symbol | Parameter | Value | Unit | |
|---------------|---------------------|--------------------|------|----------------------|
| $R_{th(j-l)}$ | Junction to leads | SMB | 13 | $^{\circ}\text{C/W}$ |
| | | SMC | 12 | |
| | | DO-15 | 35 | |
| | | DO-201 | 23 | |
| $R_{th(j-a)}$ | Junction to ambient | SMB ⁽¹⁾ | 185 | |
| | | SMC ⁽¹⁾ | 150 | |
| | | DO-15 | 105 | |
| | | DO-201 | 100 | |

1. On printed circuit with recommended pad layout

Figure 1. Electrical characteristics - definitions

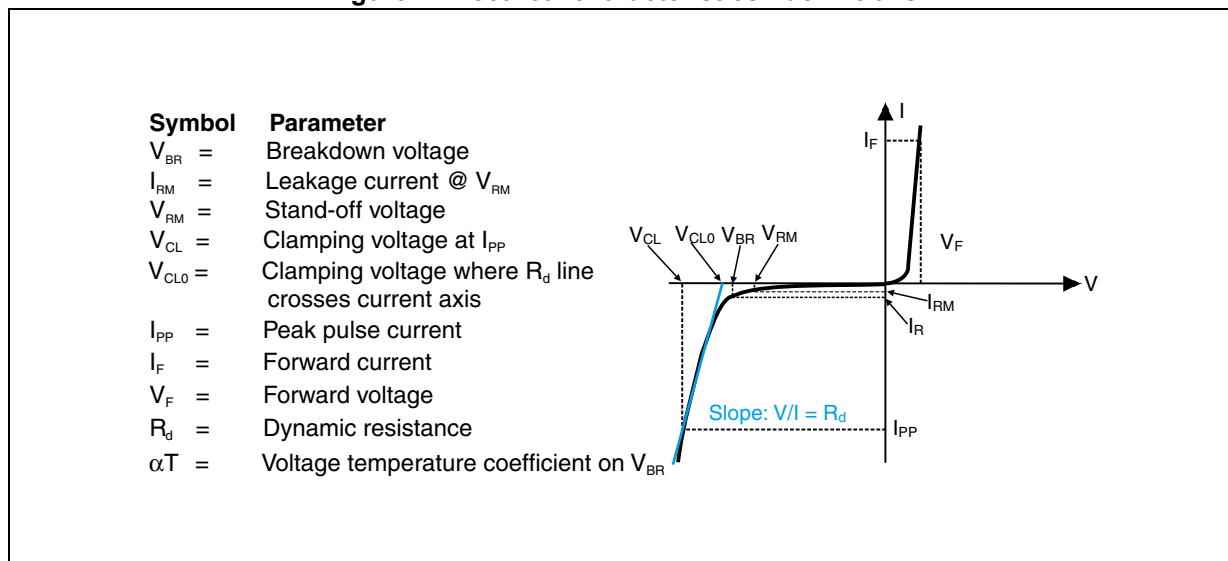

Table 4. Electrical characteristics - values

| Order code | I _{RM} max @ V _{RM} (25 °C) | | V _{BR} @ I _R ⁽¹⁾ (25 °C) | | Values @ 125 °C (typ.) | | | | αT | |
|----------------|--|-----|---|------|------------------------|-----------------------------------|------------------|-------------------------------|------|----------------------|
| | | | Min. | Max. | I _{PP} | V _{CL} @ I _{PP} | V _{CL0} | R _d ⁽²⁾ | Max. | |
| | μA | V | V | | mA | A | V | V | Ω | 10 ⁻⁴ /°C |
| STRVS118X02C | 0.2 | 85 | 95 | 105 | 1 | 2 | 118 | 116 | 1.0 | 10.6 |
| STRVS142X02F | 1 | 102 | 114 | 126 | 1 | 2 | 142 | 140 | 1.0 | 10.7 |
| STRVS182X02F | 1 | 128 | 143 | 158 | 1 | 2 | 182 | 177 | 2.5 | 10.8 |
| STRVS185X02B/E | 0.2 | 128 | 143 | 158 | 1 | 2 | 185 | 178 | 2.5 | 10.8 |
| STRVS222X02F | 1 | 154 | 171 | 189 | 1 | 2 | 222 | 213 | 4.5 | 10.8 |
| STRVS225X02E | 0.5 | 154 | 171 | 189 | 1 | 2 | 225 | 214 | 5.5 | 10.8 |
| STRVS241X02E | 0.5 | 171 | 190 | 210 | 1 | 2 | 241 | 234 | 3.5 | 10.8 |
| STRVS248X02C | 0.5 | 171 | 190 | 210 | 1 | 2 | 248 | 238 | 5.0 | 10.8 |
| STRVS252X02F | 1 | 171 | 190 | 210 | 1 | 2 | 252 | 239 | 6.5 | 10.8 |
| STRVS280X02F | 1 | 188 | 209 | 231 | 1 | 2 | 280 | 263 | 8.5 | 10.8 |

1. To calculate V_{BR} at a given junction temperature, use the following formula:

$$V_{BR} @ T_j = V_{BR} @ 25\text{ °C} \times (1 + \alpha T \times (T_j - 25))$$

$$2. R_d = (V_{CL} - V_{CL0}) / I_{PP}$$

Figure 2. Clamping voltage versus peak pulse current - STRVS118X02C (typical values)

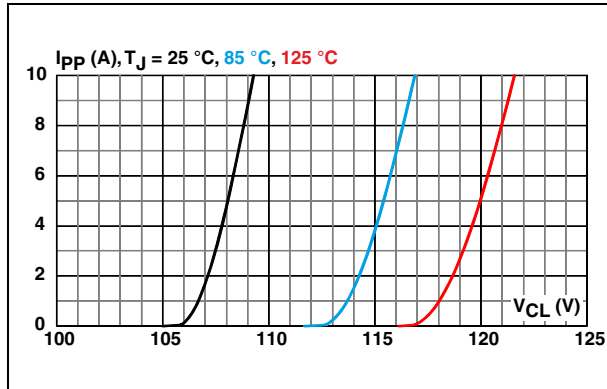

Figure 3. Clamping voltage versus peak pulse current - STRVS142X02F (typical values)

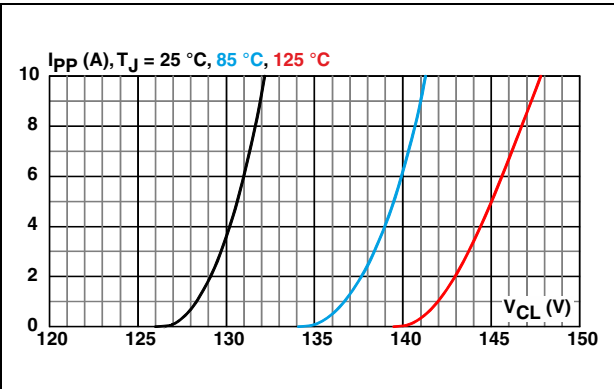

Figure 4. Clamping voltage versus peak pulse current - STRVS182X02F (typical values)

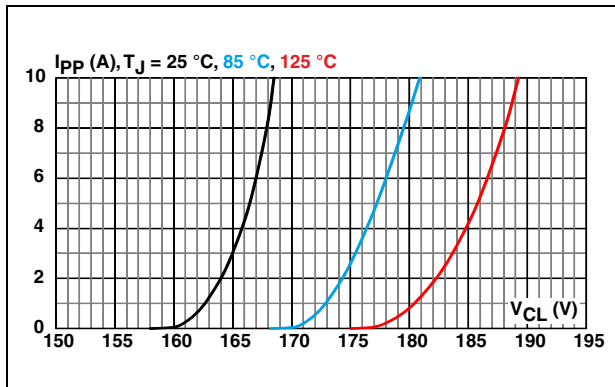

Figure 5. Clamping voltage versus peak pulse current - STRVS185X02B/E (typical values)

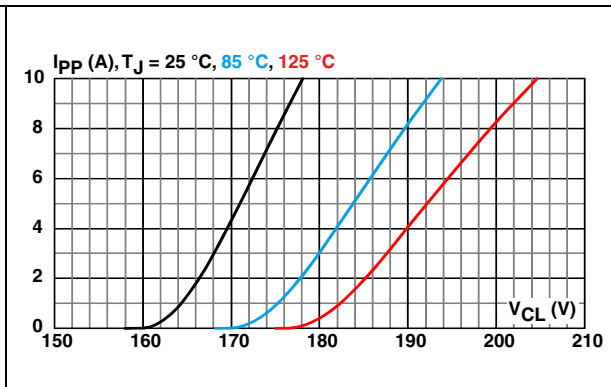

Figure 6. Clamping voltage versus peak pulse current - STRVS222X02F (typical values)

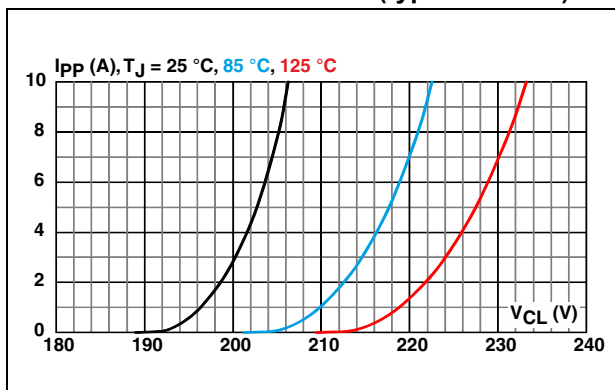

Figure 7. Clamping voltage versus peak pulse current - STRVS225X02E (typical values)

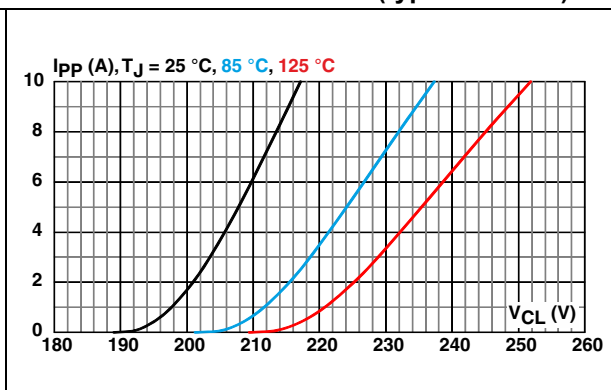

Figure 8. Clamping voltage versus peak pulse current - STRVS241X02E (typical values)

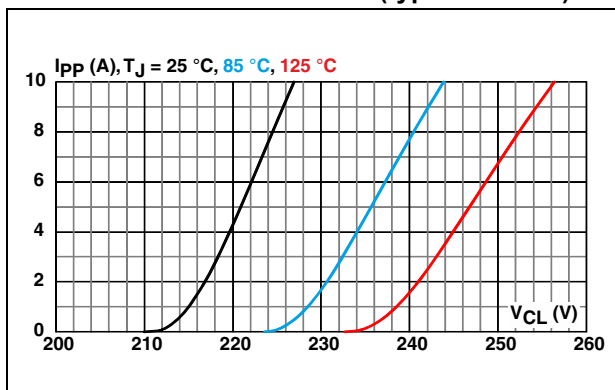

Figure 9. Clamping voltage versus peak pulse current - STRVS248X02C (typical values)

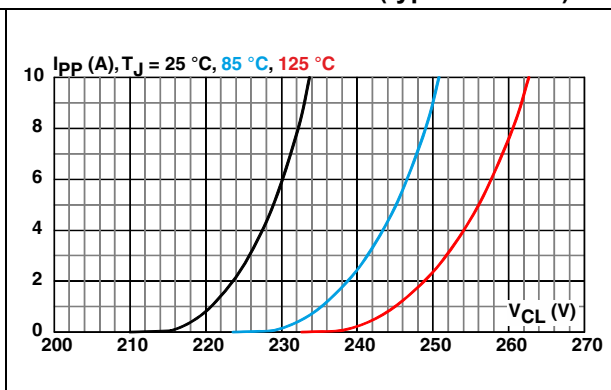

Figure 10. Clamping voltage versus peak pulse current - STRVS252X02F

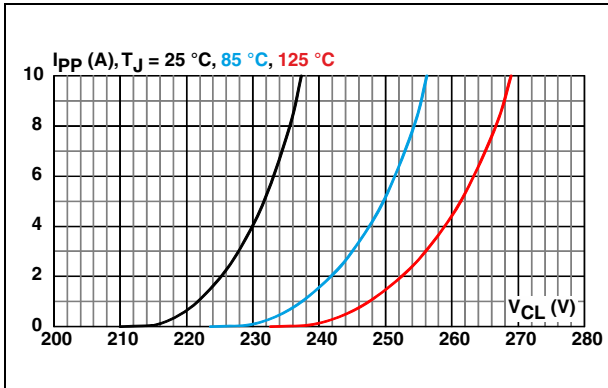

Figure 11. Clamping voltage versus peak pulse current - STRVS280X02F

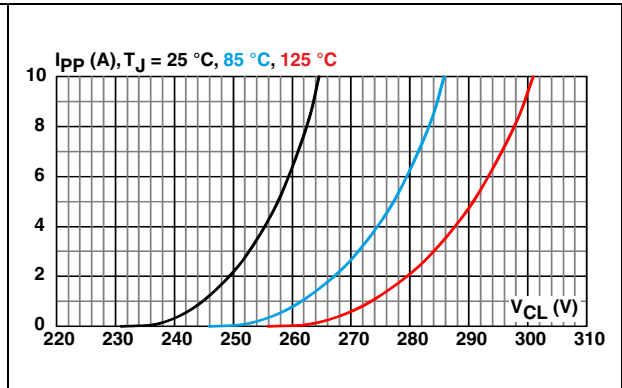

Figure 12. Leakage current versus junction temperature (typical values) STRVSxxxC

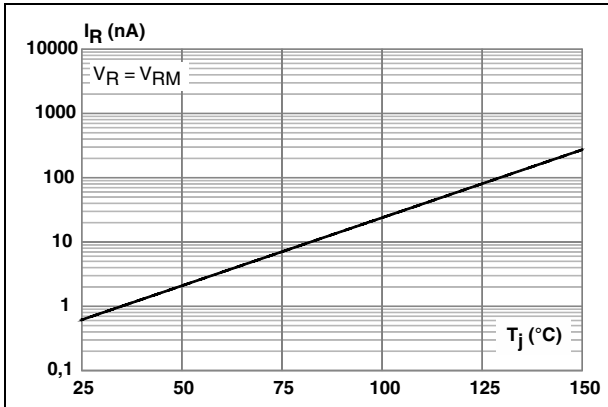

Figure 13. Leakage current versus junction temperature (typical values) STRVSxxxF

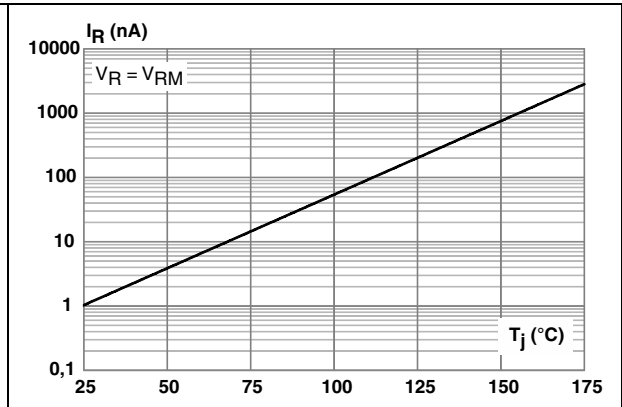

Figure 14. Leakage current versus junction temperature (typical values) STRVSxxxB

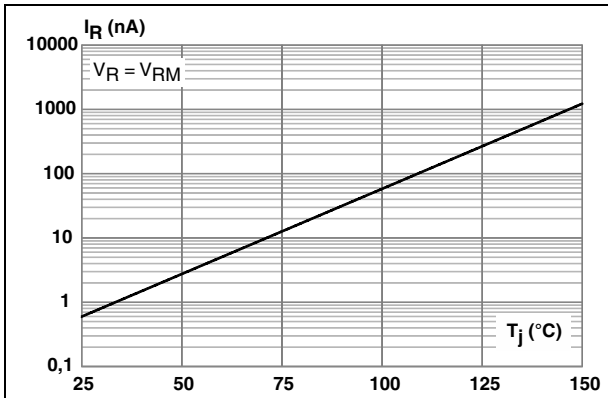

Figure 15. Leakage current versus junction temperature (typical values) STRVSxxxE

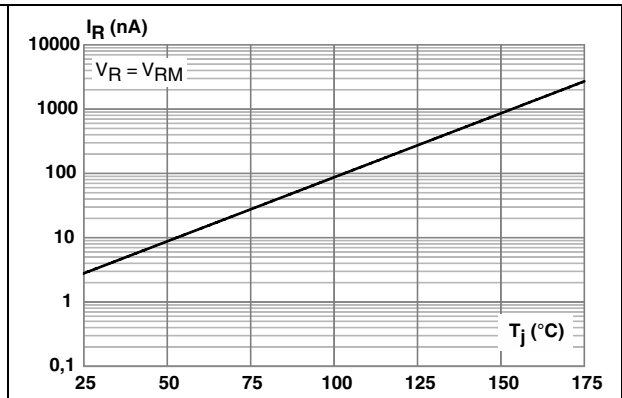

Figure 16. Thermal resistance junction to ambient versus copper surface of connections - SMB

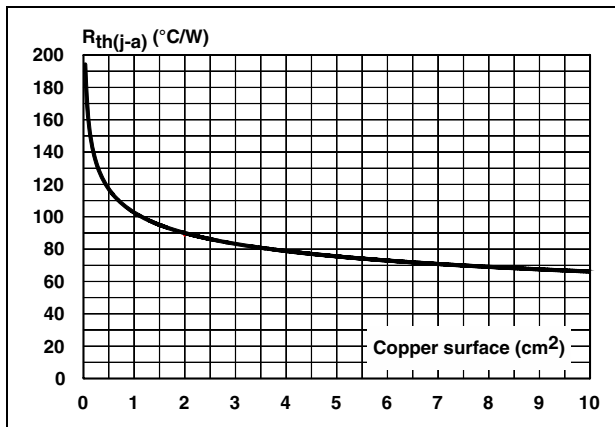

Figure 17. Thermal resistance junction to ambient versus copper surface of connections - SMC

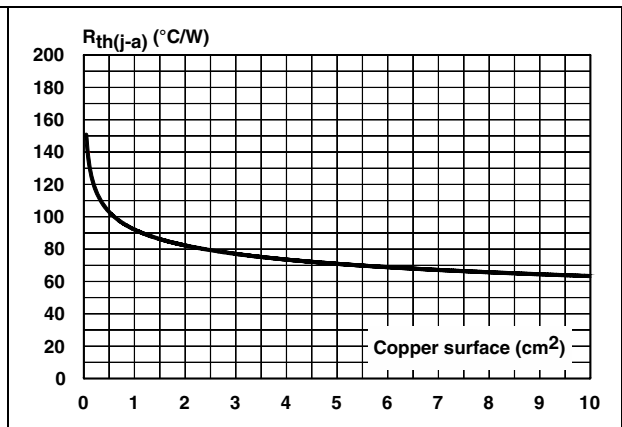

Figure 18. Thermal resistance junction to ambient versus copper surface of connections - DO-15

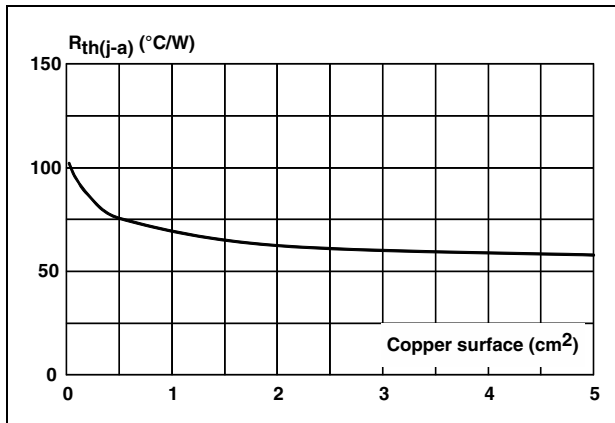
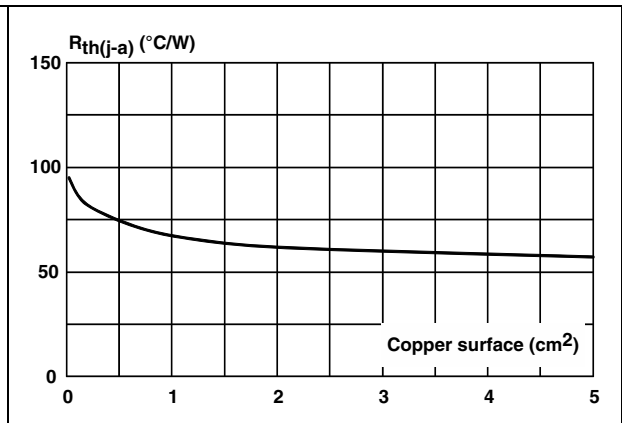

Figure 19. Thermal resistance junction to ambient versus copper surface of connections - DO-201



2 Package information

- Epoxy meets UL94, V0
- Lead-free package
- Polarity: band indicates cathode
- Terminals: solder plated, solderable as per MIL-STD-750, method 2026

In order to meet environmental requirements, ST offers these devices in different grades of ECOPACK® packages, depending on their level of environmental compliance. ECOPACK® specifications, grade definitions and product status are available at: www.st.com. ECOPACK® is an ST trademark.

2.1 SMB package information

Figure 20. SMB dimension definitions

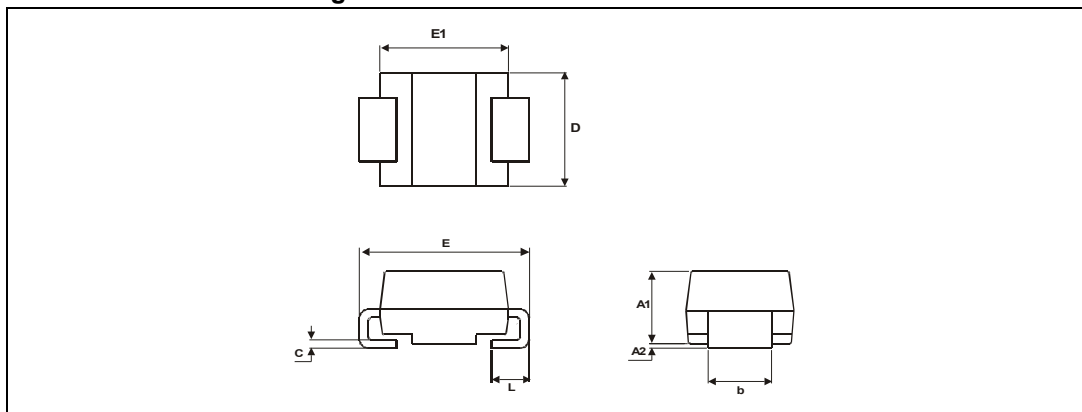

Table 5. SMB dimension values

| Ref. | Dimensions | | | |
|------|-------------|------|--------|-------|
| | Millimeters | | Inches | |
| | Min. | Max. | Min. | Max. |
| A1 | 1.90 | 2.45 | 0.075 | 0.096 |
| A2 | 0.05 | 0.20 | 0.002 | 0.008 |
| b | 1.95 | 2.20 | 0.077 | 0.087 |
| c | 0.15 | 0.40 | 0.006 | 0.016 |
| D | 3.30 | 3.95 | 0.130 | 0.156 |
| E | 5.10 | 5.60 | 0.201 | 0.220 |
| E1 | 4.05 | 4.60 | 0.159 | 0.181 |
| L | 0.75 | 1.50 | 0.030 | 0.059 |

Figure 21. SMB Footprint, dimensions in mm (inches)

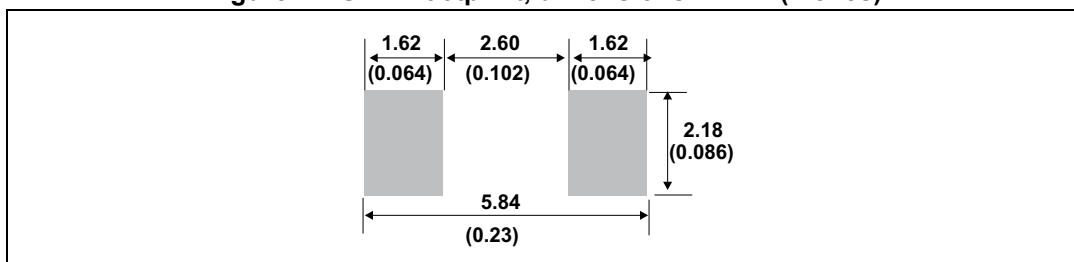
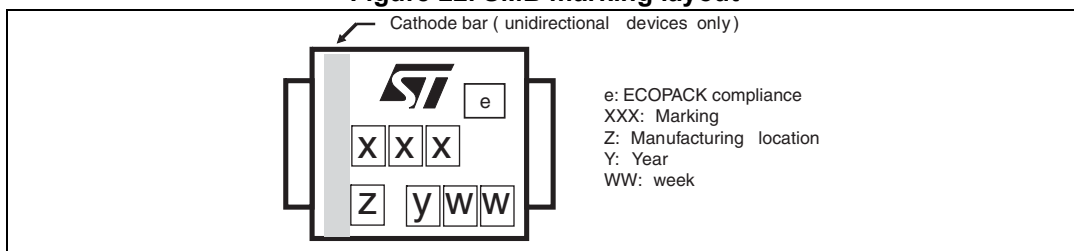

Figure 22. SMB marking layout



2.2 SMC package information

Figure 23. SMC dimension definitions

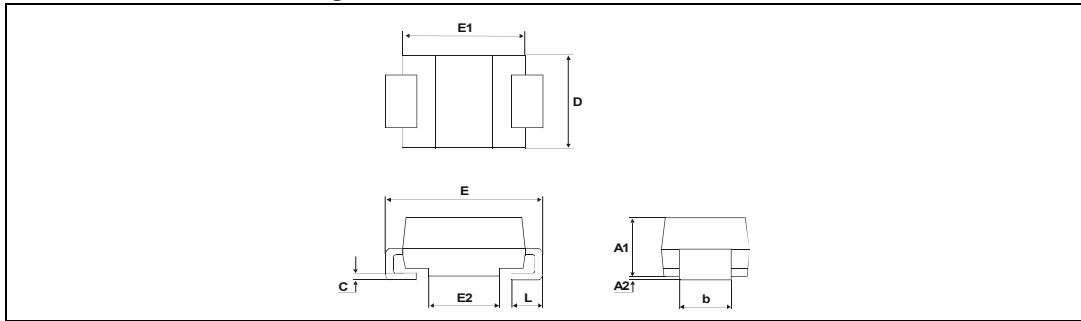

Table 6. SMC dimension values

| Ref. | Dimensions | | | |
|------|-------------|------|--------|-------|
| | Millimeters | | Inches | |
| | Min. | Max. | Min. | Max. |
| A1 | 1.90 | 2.45 | 0.075 | 0.096 |
| A2 | 0.05 | 0.20 | 0.002 | 0.008 |
| b | 2.90 | 3.20 | 0.114 | 0.126 |
| c | 0.15 | 0.40 | 0.006 | 0.016 |
| D | 5.55 | 6.25 | 0.218 | 0.246 |
| E | 7.75 | 8.15 | 0.305 | 0.321 |
| E1 | 6.60 | 7.15 | 0.260 | 0.281 |
| E2 | 4.40 | 4.70 | 0.173 | 0.185 |
| L | 0.75 | 1.50 | 0.030 | 0.059 |

Figure 24. SMC footprint, dimensions in mm (inches)

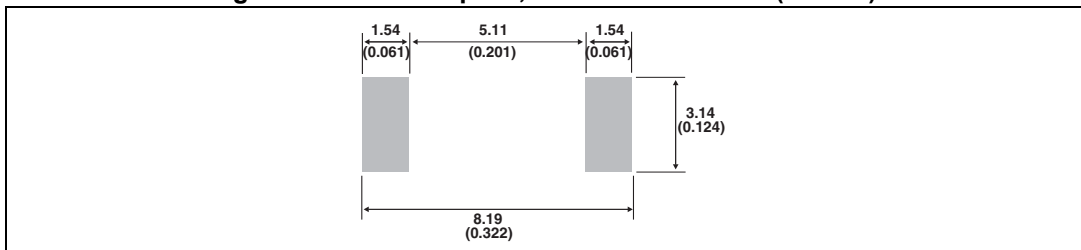
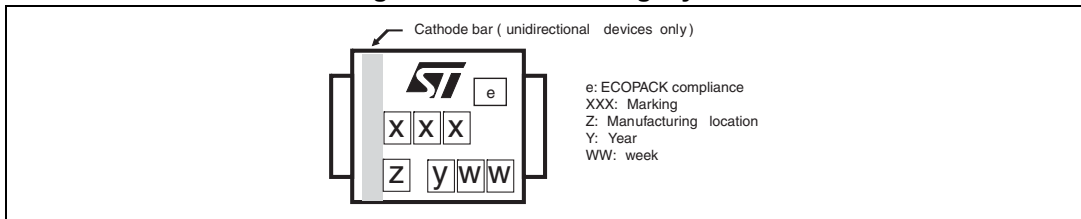

Figure 25. SMC marking layout



2.3 DO-15 package information

Figure 26. DO-15 dimension definitions

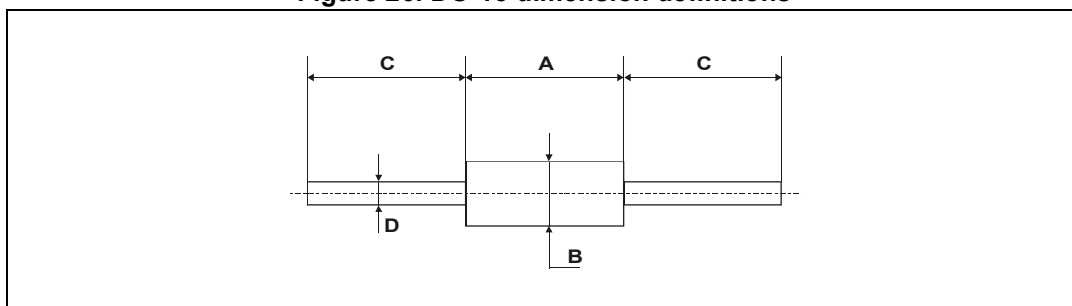

Table 7. DO-15 dimension values

| Ref. | Dimensions | | | |
|------|-------------|------|--------|-------|
| | Millimeters | | Inches | |
| | Min. | Max. | Min. | Max. |
| A | 6.05 | 6.75 | 0.238 | 0.266 |
| B | 2.95 | 3.53 | 0.116 | 0.139 |
| C | 26 | 31 | 1.024 | 1.220 |
| D | 0.71 | 0.88 | 0.028 | 0.035 |

2.4 DO-201 package information

Figure 27. DO-201 dimension definitions

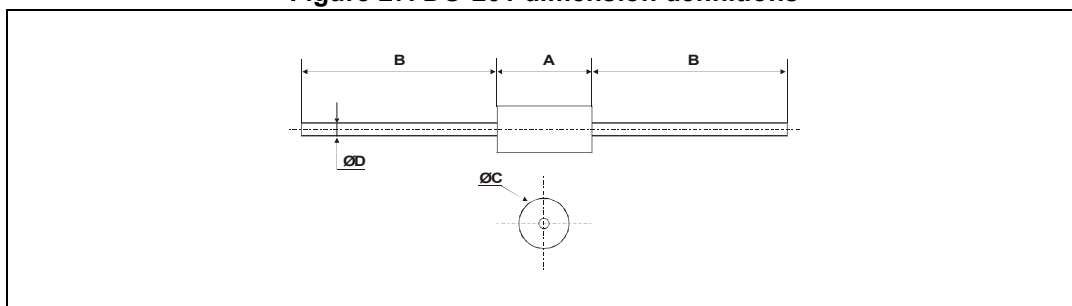

Table 8. DO-201 dimension values

| Ref. | Dimensions | | | |
|------|-------------|------|--------|-------|
| | Millimeters | | Inches | |
| | Min. | Max. | Min. | Max. |
| A | 8.5 | 9.5 | 0.335 | 0.374 |
| B | 25.4 | | 1 | |
| Ø C | 4.8 | 5.3 | 0.189 | 0.209 |
| Ø D | 0.96 | 1.06 | 0.038 | 0.042 |

3 Ordering information

Figure 28. Ordering information scheme

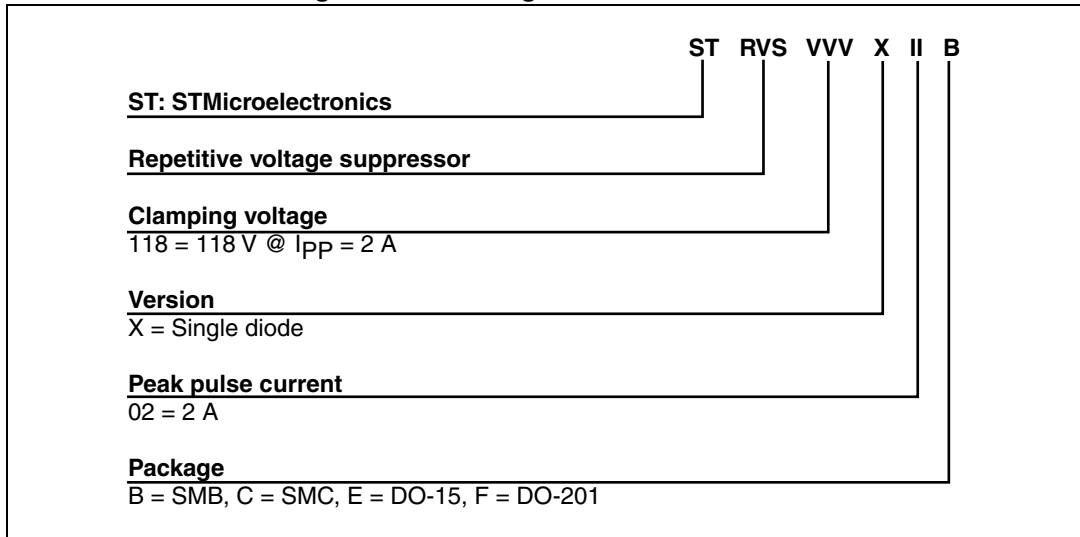

Table 9. Ordering information

| Order code | Marking | Package | Weight | Base qty. | Delivery mode |
|--------------|---------|---------|--------|-----------|---------------|
| STRVS118X02C | R118C | SMC | 0.25 g | 2500 | Tape and reel |
| STRVS142X02F | R142F | DO-201 | 0.90 g | 600 | Ammopack |
| STRVS182X02F | R182F | DO-201 | 0.90 g | 600 | Ammopack |
| STRVS185X02B | R185B | SMB | 0.12 g | 2500 | Tape and reel |
| STRVS185X02E | R185E | DO-15 | 0.40 g | 1000 | Ammopack |
| STRVS222X02F | R222F | DO-201 | 0.90 g | 600 | Ammopack |
| STRVS225X02E | R225E | DO-15 | 0.40 g | 1000 | Ammopack |
| STRVS241X02E | R241E | DO-15 | 0.40 g | 1000 | Ammopack |
| STRVS248X02C | R4248C | SMC | 0.25 g | 2500 | Tape and reel |
| STRVS252X02F | R252F | DO-201 | 0.90 g | 600 | Ammopack |
| STRVS280X02F | R280F | DO-201 | 0.90 g | 600 | Ammopack |

4 Revision history

Table 10. Document revision history

| Date | Revision | Changes |
|-------------|----------|--|
| 05-Mar-2013 | 1 | Initial release. |
| 18-Apr-2013 | 2 | Insertion of Table 1 . |
| 15-Oct-2013 | 3 | Updated Table 1 . |
| 14-Sep-2015 | 4 | Updated features on cover page and Figure 21 . Updated Table 3 , Table 4 , Table 6 and Table 9 . Minor text changes. |

IMPORTANT NOTICE – PLEASE READ CAREFULLY

STMicroelectronics NV and its subsidiaries ("ST") reserve the right to make changes, corrections, enhancements, modifications, and improvements to ST products and/or to this document at any time without notice. Purchasers should obtain the latest relevant information on ST products before placing orders. ST products are sold pursuant to ST's terms and conditions of sale in place at the time of order acknowledgement.

Purchasers are solely responsible for the choice, selection, and use of ST products and ST assumes no liability for application assistance or the design of Purchasers' products.

No license, express or implied, to any intellectual property right is granted by ST herein.

Resale of ST products with provisions different from the information set forth herein shall void any warranty granted by ST for such product.

ST and the ST logo are trademarks of ST. All other product or service names are the property of their respective owners.

Information in this document supersedes and replaces information previously supplied in any prior versions of this document.

© 2015 STMicroelectronics – All rights reserved

Mouser Electronics

Authorized Distributor

Click to View Pricing, Inventory, Delivery & Lifecycle Information:

STMicroelectronics:

[STRVS142X02F](#) [STRVS182X02F](#) [STRVS185X02E](#) [STRVS222X02F](#) [STRVS225X02E](#) [STRVS241X02E](#)
[STRVS252X02F](#) [STRVS280X02F](#) [STRVS118X02C](#) [STRVS185X02B](#) [STRVS248X02C](#)