

Features

- Formerly **FulTec** brand
- Extremely high speed performance
- Low impedance
- Two TBU® protectors in one small package
- Very high bandwidth, GHz compatible
- Simple, superior circuit protection
- RoHS compliant*, UL Recognized

Applications

- xDSL (ADSL, VDSL, VDSL2)
- High Data Rate Interface IC protection (LVDS, HDMI, etc.)
- Industrial sensors and controls
- General electronics

P40-G Series TBU® High-Speed Protectors

Transient Blocking Units - TBU® Devices

Bourns® Model P40-G products are high-speed bidirectional protection components, constructed using MOSFET semiconductor technology, designed to protect against faults caused by short circuits, AC power cross, induction and lightning surges.

The TBU® high-speed protector, triggering as a function of the MOSFET, blocks surges and provides an effective barrier behind which sensitive electronics are not exposed to large voltages or currents during surge events. The TBU® device is provided in a surface mount DFN package and meets industry standard requirements such as RoHS and Pb Free solder reflow profiles.

Agency Approval

UL recognized component File # E315805.

Industry Standards

Description		Model
Telcordia	GR-1089	P40-G
ITU-T	K.20, K.20E, K.21, K.21E, K.45	

Absolute Maximum Ratings (T_{amb} = 25 °C)

Symbol	Parameter	Value	Unit
V _{imp}	Maximum protection voltage for impulse faults with rise time ≥ 1 μsec	40	V
V _{rms}	Maximum protection voltage for continuous V _{rms} faults	28	V
T _{op}	Operating temperature range	-55 to +125	°C
T _{stg}	Storage temperature range	-65 to +150	°C
T _{jmax}	Maximum Junction Temperature	+125	°C

Electrical Characteristics (T_{amb} = 25 °C)

Symbol	Parameter	Min.	Typ.	Max.	Unit
I _{op}	Maximum current through the device that will not cause current blocking			240	mA
I _{trigger}	Typical current for the device to go from normal operating state to protected state		350		mA
I _{out}	Maximum current through the device			480	mA
R _{device}	Series resistance of the TBU® device		3.6	4.2	Ω
R _{bal}	Line-to line series resistance difference between two TBU® devices			5	%
t _{block}	Maximum time for the device to go from normal operating state to protected state			0.2	μs
I _{quiescent}	Current through the triggered TBU® device with 40 Vdc circuit voltage		0.7		mA
V _{reset}	Voltage below which the triggered TBU® device will transition to normal operating state		7		V
R _{θJA}	Junction to air thermal resistance, FR4 PCB. 0.035 sq. in. of copper in addition to solder pads		130		°C/W

The P40-G Series TBU® high-speed protector is bidirectional; specifications are valid in both directions.

Environmental Characteristics

Parameter	Value
Moisture Sensitivity Level	1
ESD Classification (HBM)	1C



WARNING Cancer and Reproductive Harm
www.P65Warnings.ca.gov

*RoHS Directive 2002/95/EC Jan. 27, 2003 including annex and RoHS Recast 2011/65/EU June 8, 2011. Specifications are subject to change without notice. Users should verify actual device performance in their specific applications. The products described herein and this document are subject to specific legal disclaimers as set forth on the last page of this document, and at www.bourns.com/docs/legal/disclaimer.pdf.

Typical Performance Characteristics

V-I Characteristics

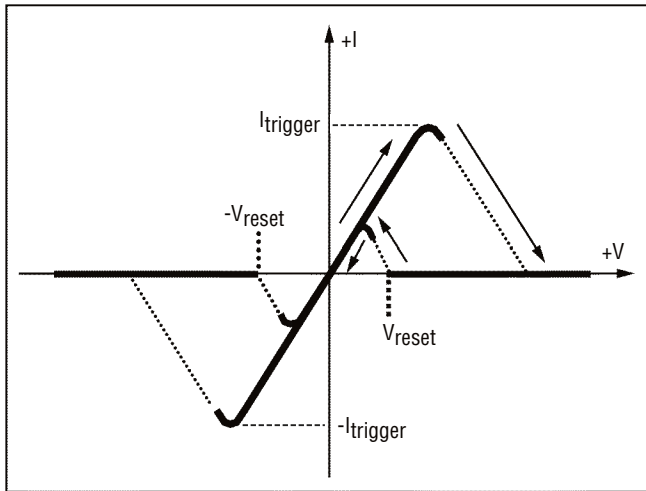

Time to Block vs. Fault Current

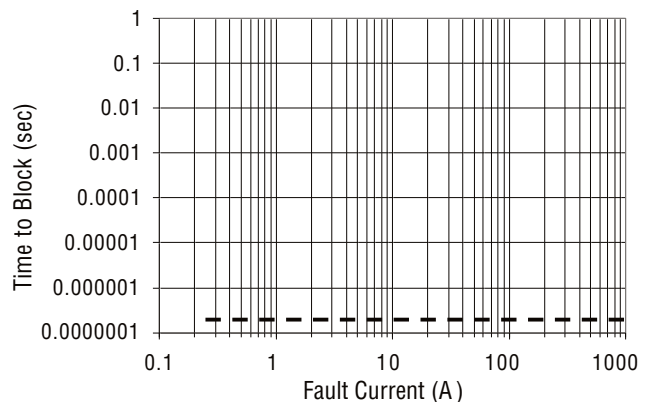

Trigger Current vs. Temperature

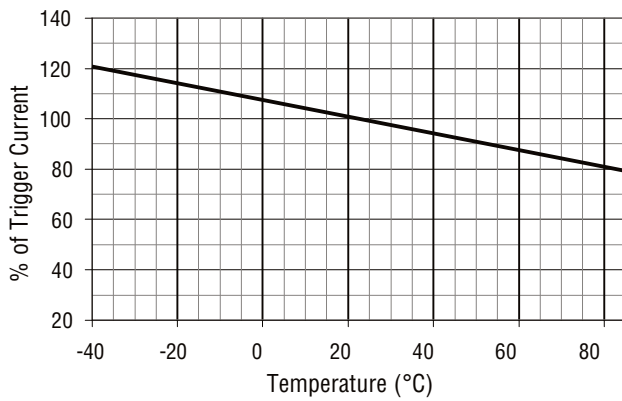

P40-G Series TBU® High-Speed Protectors

BOURNS®

Operational Characteristics

The graph below demonstrates the operational characteristics of the TBU® device. In the graph below the fault voltage, protected side voltage, and current is presented.

TEST CONFIGURATION DIAGRAM

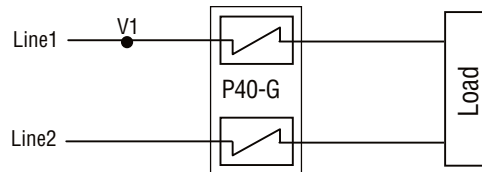

P40-G Lightning Protection 40 V

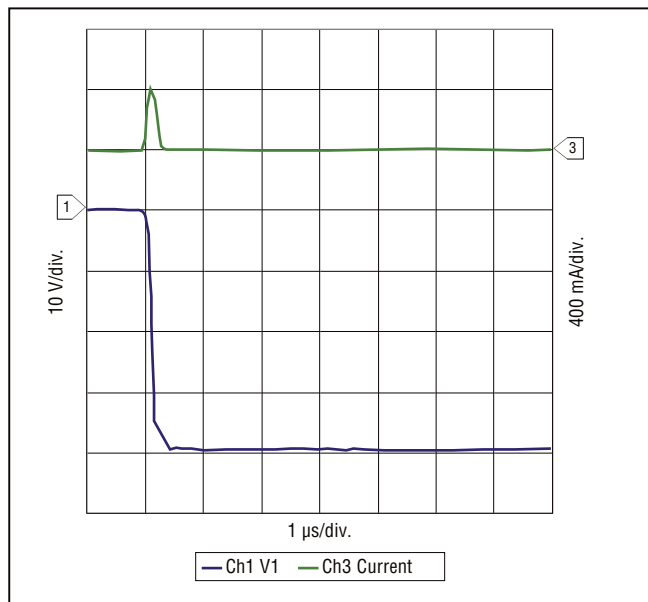

Specifications are subject to change without notice.

Users should verify actual device performance in their specific applications.

The products described herein and this document are subject to specific legal disclaimers as set forth on the last page of this document, and at www.bourns.com/docs/legal/disclaimer.pdf.

P40-G Series TBU® High-Speed Protectors

BOURNS®

Product Dimensions

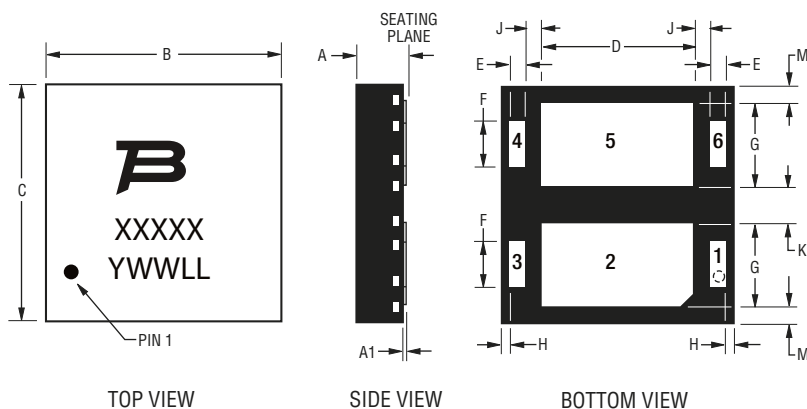

Dim.	Min.	Typ.	Max.
A	0.80 (.031)	0.90 (.035)	1.00 (.039)
A1	0.00 (.000)	0.025 (.001)	0.05 (.002)
B	3.90 (.154)	4.00 (.157)	4.10 (.161)
C	3.90 (.154)	4.00 (.157)	4.10 (.161)
D	2.55 (.100)	2.60 (.102)	2.65 (.104)
E	0.20 (.008)	0.25 (.010)	0.30 (.012)
F	0.75 (.030)	0.80 (.031)	0.85 (.033)
G	1.40 (.055)	1.45 (.057)	1.50 (.059)
H	0.10 (.004)	0.15 (.006)	0.20 (.008)
J	0.25 (.010)	0.30 (.012)	0.35 (.014)
K	0.55 (.022)	0.60 (.024)	0.65 (.026)
M	0.20 (.008)	0.25 (.010)	0.30 (.012)

Recommended Pad Layout

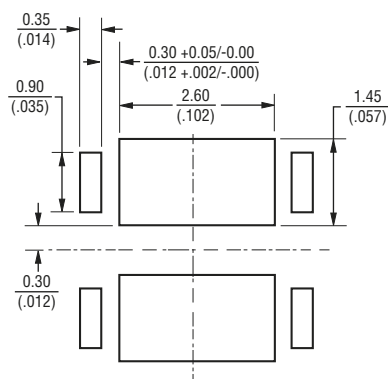

Pad Designation

Pad #	Apply
1	In1
2	NC
3	Out1
4	Out2
5	NC
6	In2

NC = Solder to PCB; do not make electrical connection, do not connect to ground.

TBU® devices have matte-tin termination finish. Suggested layout should use non-solder mask define (NSMD). Recommended stencil thickness is 0.10-0.12 mm (.004-.005 in.) with stencil opening size 0.025 mm (.0010 in.) less than the device pad size. As when heat sinking any power device, it is recommended that, wherever possible, extra PCB copper area is allowed. For minimum parasitic capacitance, do not allow any signal, ground or power signals beneath any of the pads of the device.

DIMENSIONS: $\frac{\text{MM}}{\text{(INCHES)}}$

Block Diagram

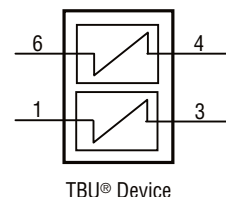

Thermal Resistances

Thermal resistance using minimal pad size, where the power is the total power dissipated in the package. Additional copper pad area to be used for additional heatsinking is also recommended.

Symbol	Parameter	Value	Unit
R _{th(j-a)}	Junction to Package Pads (1 TBU of Pair)	250	°C/W
R _{th(j-a)}	Junction to Package Pads (2 TBUs of Equal Power)	180	°C/W

Specifications are subject to change without notice.

Users should verify actual device performance in their specific applications.

The products described herein and this document are subject to specific legal disclaimers as set forth on the last page of this document, and at www.bourns.com/docs/legal/disclaimer.pdf.

P40-G Series TBU® High-Speed Protectors

BOURNS®

Reflow Profile

Profile Feature	Pb-Free Assembly
Average Ramp-Up Rate (T _{Smax} to T _P)	3 °C/sec. max.
Preheat <ul style="list-style-type: none"> - Temperature Min. (T_{Smin}) - Temperature Max. (T_{Smax}) - Time (t_{Smin} to t_{Smax}) 	150 °C 200 °C 60-180 sec.
Time maintained above: <ul style="list-style-type: none"> - Temperature (T_L) - Time (t_L) 	217 °C 60-150 sec.
Peak/Classification Temperature (T _P)	260 °C
Time within 5 °C of Actual Peak Temp. (t _P)	20-40 sec.
Ramp-Down Rate	6 °C/sec. max.
Time 25 °C to Peak Temperature	8 min. max.

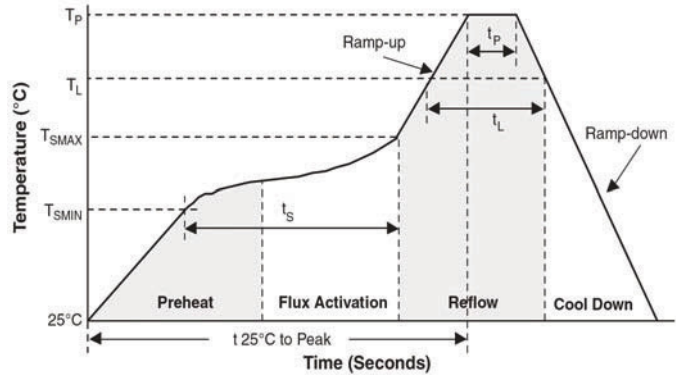

How to Order

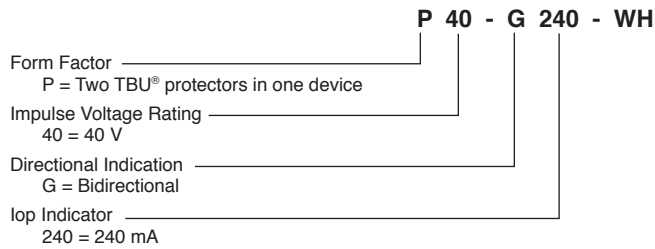

Typical Part Marking

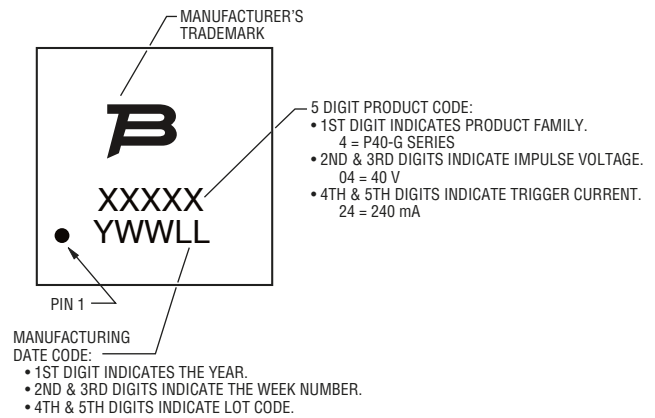

Specifications are subject to change without notice.

Users should verify actual device performance in their specific applications.

The products described herein and this document are subject to specific legal disclaimers as set forth on the last page of this document, and at www.bourns.com/docs/legal/disclaimer.pdf.

P40-G Series TBU® High-Speed Protectors

BOURNS®

Packaging Specifications (per EIA468-B)

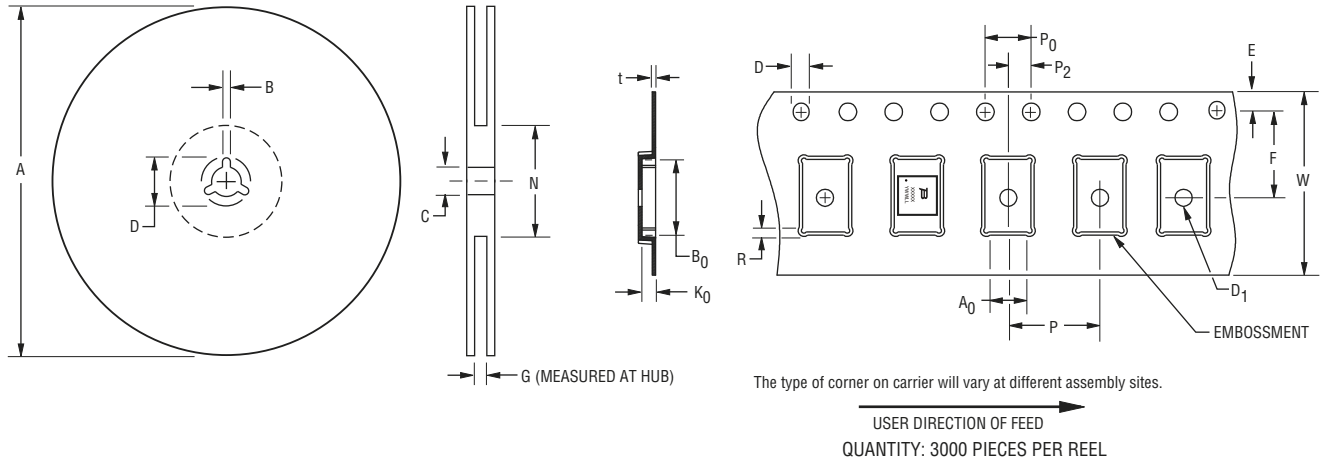

Device	A		B		C		D		G	N
	Min.	Max.	Min.	Max.	Min.	Max.	Min.	Max.	Ref.	Ref.
P40-G240	$\frac{326}{(12.835)}$	$\frac{330.25}{(13.002)}$	$\frac{1.5}{(.059)}$	$\frac{2.5}{(.098)}$	$\frac{12.8}{(.504)}$	$\frac{13.5}{(.531)}$	$\frac{20.2}{(.795)}$	-	$\frac{12.4}{(.488)}$	$\frac{102}{(4.016)}$

A ₀		B ₀		D		D ₁		E		F	
Min.	Max.	Min.	Max.	Min.	Max.	Min.	Max.	Min.	Max.	Min.	max.
$\frac{4.2}{(.165)}$	$\frac{4.4}{(.173)}$	$\frac{4.2}{(.165)}$	$\frac{4.4}{(.173)}$	$\frac{1.5}{(.059)}$	$\frac{1.6}{(.063)}$	$\frac{1.5}{(.059)}$	-	$\frac{1.65}{(.065)}$	$\frac{1.85}{(.073)}$	$\frac{5.45}{(.216)}$	$\frac{5.55}{(.219)}$

K ₀		P		P ₀		P ₂		R		t	
Min.	Max.	Min.	Max.	Min.	Max.	Min.	Max.	Min.	Max.	Min.	Max.
$\frac{1.05}{(.041)}$	$\frac{1.25}{(.049)}$	$\frac{7.9}{(.311)}$	$\frac{8.1}{(.319)}$	$\frac{3.9}{(.159)}$	$\frac{4.1}{(.161)}$	$\frac{1.9}{(.075)}$	$\frac{2.1}{(.083)}$	$\frac{0}{(0)}$	$\frac{0.5}{(.020)}$	$\frac{0.25}{(.010)}$	$\frac{0.35}{(.014)}$

W	
Min.	Max.
$\frac{11.7}{(.461)}$	$\frac{12.3}{(.484)}$

DIMENSIONS: $\frac{\text{MM}}{\text{(INCHES)}}$

Specifications are subject to change without notice.

Users should verify actual device performance in their specific applications.

The products described herein and this document are subject to specific legal disclaimers as set forth on the last page of this document, and at www.bourns.com/docs/legal/disclaimer.pdf.

P40-G Series TBU® High-Speed Protectors

BOURNS®

Reference Application

A cost-effective protection solution combines the Bourns® TBU® protection device with a diode bridge on the driver side of the transformer and GDTs on the line side. The GDT should have a minimum DCBD of 900 V and a maximum sparkover voltage of 1600 V. The diagram below illustrates a common configuration of these components. The graph demonstrates the operational characteristics of the circuit.

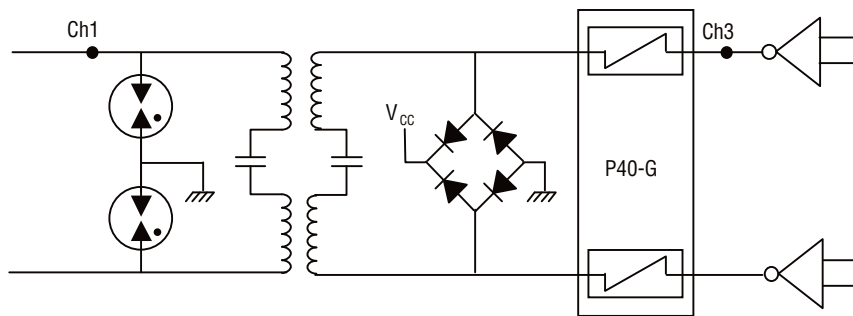

Common Configuration Diagram - xDSL Protection

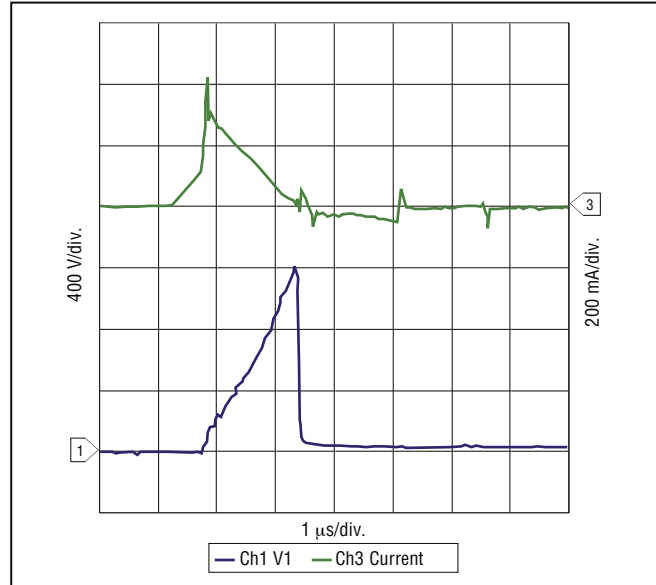

5000 V Lightning 2/10 μsec, 500 A

REV. 04/18

"TBU" is a registered trademark of Bourns, Inc. in the United States and other countries.

Specifications are subject to change without notice.

Users should verify actual device performance in their specific applications.

The products described herein and this document are subject to specific legal disclaimers as set forth on the last page of this document, and at www.bourns.com/docs/legal/disclaimer.pdf.

This legal disclaimer applies to purchasers and users of Bourns® products manufactured by or on behalf of Bourns, Inc. and its affiliates (collectively, “Bourns”).

Unless otherwise expressly indicated in writing, Bourns® products and data sheets relating thereto are subject to change without notice. Users should check for and obtain the latest relevant information and verify that such information is current and complete before placing orders for Bourns® products.

The characteristics and parameters of a Bourns® product set forth in its data sheet are based on laboratory conditions, and statements regarding the suitability of products for certain types of applications are based on Bourns’ knowledge of typical requirements in generic applications. The characteristics and parameters of a Bourns® product in a user application may vary from the data sheet characteristics and parameters due to (i) the combination of the Bourns® product with other components in the user’s application, or (ii) the environment of the user application itself. The characteristics and parameters of a Bourns® product also can and do vary in different applications and actual performance may vary over time. Users should always verify the actual performance of the Bourns® product in their specific devices and applications, and make their own independent judgments regarding the amount of additional test margin to design into their device or application to compensate for differences between laboratory and real world conditions.

Unless Bourns has explicitly designated an individual Bourns® product as meeting the requirements of a particular industry standard (e.g., ISO/TS 16949) or a particular qualification (e.g., UL listed or recognized), Bourns is not responsible for any failure of an individual Bourns® product to meet the requirements of such industry standard or particular qualification. Users of Bourns® products are responsible for ensuring compliance with safety-related requirements and standards applicable to their devices or applications.

Bourns® products are not recommended, authorized or intended for use in nuclear, lifesaving, life-critical or life-sustaining applications, nor in any other applications where failure or malfunction may result in personal injury, death, or severe property or environmental damage. Unless expressly and specifically approved in writing by two authorized Bourns representatives on a case-by-case basis, use of any Bourns® products in such unauthorized applications might not be safe and thus is at the user’s sole risk. Life-critical applications include devices identified by the U.S. Food and Drug Administration as Class III devices and generally equivalent classifications outside of the United States.

Bourns expressly identifies those Bourns® standard products that are suitable for use in automotive applications on such products’ data sheets in the section entitled “Applications.” Unless expressly and specifically approved in writing by two authorized Bourns representatives on a case-by-case basis, use of any other Bourns® standard products in an automotive application might not be safe and thus is not recommended, authorized or intended and is at the user’s sole risk. If Bourns expressly identifies a sub-category of automotive application in the data sheet for its standard products (such as infotainment or lighting), such identification means that Bourns has reviewed its standard product and has determined that if such Bourns® standard product is considered for potential use in automotive applications, it should only be used in such sub-category of automotive applications. Any reference to Bourns® standard product in the data sheet as compliant with the AEC-Q standard or “automotive grade” does not by itself mean that Bourns has approved such product for use in an automotive application.

Bourns® standard products are not tested to comply with United States Federal Aviation Administration standards generally or any other generally equivalent governmental organization standard applicable to products designed or manufactured for use in aircraft or space applications. Bourns expressly identifies Bourns® standard products that are suitable for use in aircraft or space applications on such products’ data sheets in the section entitled “Applications.” Unless expressly and specifically approved in writing by two authorized Bourns representatives on a case-by-case basis, use of any other Bourns® standard product in an aircraft or space application might not be safe and thus is not recommended, authorized or intended and is at the user’s sole risk.

The use and level of testing applicable to Bourns® custom products shall be negotiated on a case-by-case basis by Bourns and the user for which such Bourns® custom products are specially designed. Absent a written agreement between Bourns and the user regarding the use and level of such testing, the above provisions applicable to Bourns® standard products shall also apply to such Bourns® custom products.

Users shall not sell, transfer, export or re-export any Bourns® products or technology for use in activities which involve the design, development, production, use or stockpiling of nuclear, chemical or biological weapons or missiles, nor shall they use Bourns® products or technology in any facility which engages in activities relating to such devices. The foregoing restrictions apply to all uses and applications that violate national or international prohibitions, including embargos or international regulations. Further, Bourns® products and Bourns technology and technical data may not under any circumstance be exported or re-exported to countries subject to international sanctions or embargoes. Bourns® products may not, without prior authorization from Bourns and/or the U.S. Government, be resold, transferred, or re-exported to any party not eligible to receive U.S. commodities, software, and technical data.

To the maximum extent permitted by applicable law, Bourns disclaims (i) any and all liability for special, punitive, consequential, incidental or indirect damages or lost revenues or lost profits, and (ii) any and all implied warranties, including implied warranties of fitness for particular purpose, non-infringement and merchantability.

For your convenience, copies of this Legal Disclaimer Notice with German, Spanish, Japanese, Traditional Chinese and Simplified Chinese bilingual versions are available at:

Web Page: <http://www.bourns.com/legal/disclaimers-terms-and-policies>

PDF: <http://www.bourns.com/docs/Legal/disclaimer.pdf>