



FEATURES

- RoHS compliant
- 1.27µH to 17.6µH
- Up to 15.4A I_{DC}
- Toroidal construction minimizes EMI
- Compact size
- Surface mount
- UL94 V-0 package materials
- Pick & place compatible
- J-STD-020C reflow
- Backward compatible with Sn/Pb soldering systems

DESCRIPTION

The 4200 series is a range of surface mount toroidal inductors designed for use in switching power supplies and DC/DC converters. The parts are ideal for applications requiring low profile compact components in a surface mount package.

SELECTION GUIDE

Order Code	Inductance (100kHz, 0.1V _{AC}) ±15% µH	DC Current ¹ Max. A	DC Resistance Max. mΩ	SRF Min. MHz	Package Dimensions (Max.)			Pad Dimensions			Carrier Tape Dimensions			Package Weight Typ. g	Reel (Box) Quantity ³
					A mm	B mm	C mm	D mm	E mm	F mm	G mm	H mm			
Discontinued															
42132C	1.27	14.3	2.5	244	15.70	9.4	15.37	12.70	11.18	20	24	9.5	3.5	300	
42212C	2.10	11.5	3.8	162	15.70	9.4	15.37	12.70	11.18	20	24	9.5	3.4	(60)	
42282C	2.84	13.9	3.5	116	17.00	9.9	17.00	14.48	12.45	24	32	10.5	5.0		
42422C	4.23	11.4	5.2	90	17.00	9.9	17.00	14.48	12.45	24	32	10.5	4.8	250	
42652C	6.5	12.4	6.0	57	18.80	9.9	18.80	16.26	14.20	24	32	10.7	6.8	(60)	
42842C	8.45	10.4	8.0	50	18.80	9.9	18.80	16.26	14.20	24	32	10.7	6.4		
42103C	10.2	15.4	6.0	38	23.88	9.9	23.88	21.08	17.78	32	44	10.8	12.3	180	
42183C	17.6	10.9	11.6	24	23.88	9.9	23.88	21.08	17.78	32	44	10.8	12.5	(35)	

ABSOLUTE MAXIMUM RATINGS

Operating temperature range	-40°C to +125°C
Storage temperature range	-40°C to +130°C

SOLDERING INFORMATION²

Peak reflow temperature	245°C
Pin finish	Pure tin dip
Moisture sensitivity level	1

All specifications typical at T_A=25°C

- 1 Maximum DC current occurs when the temperature rise reaches 55°C.
- 2 For further information, please visit www.murata-ps.com/rohs
- 3 If components are required in tape & reel format, suffix order code with '-R', e.g. 42132C-R



For full details go to
www.murata-ps.com/rohs

INDUCTANCE Vs CURRENT

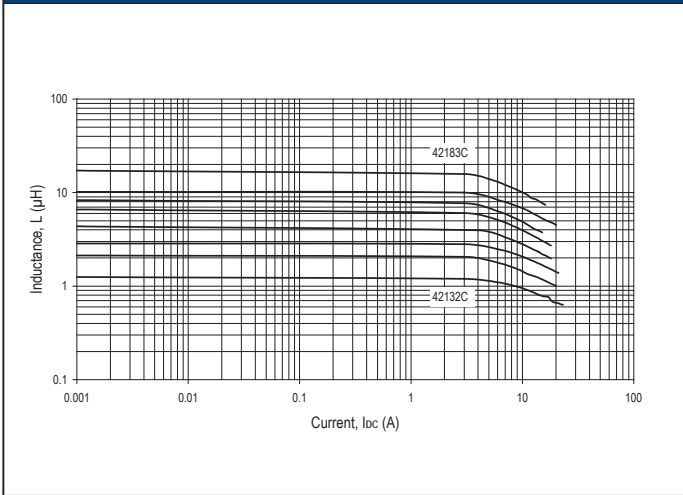

INDUCTANCE Vs FREQUENCY

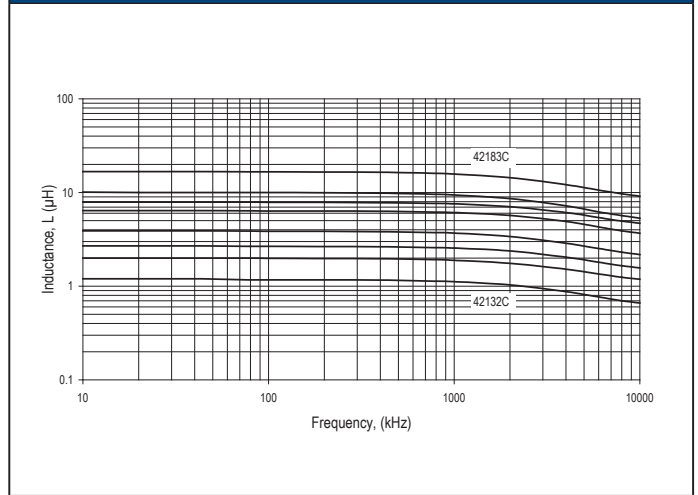

TEMPERATURE Vs CURRENT

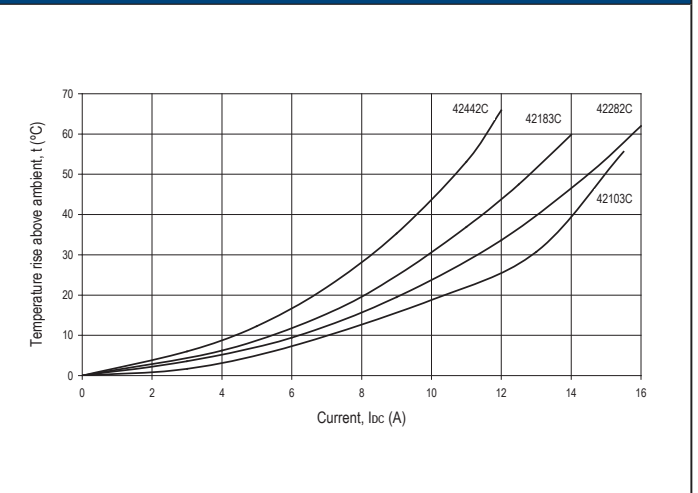
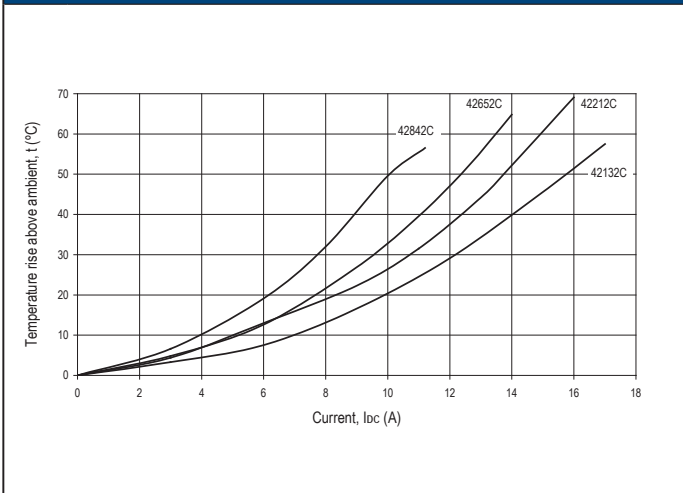

PACKAGE SPECIFICATIONS

MECHANICAL DIMENSIONS

See Selection Guide for dimensions.

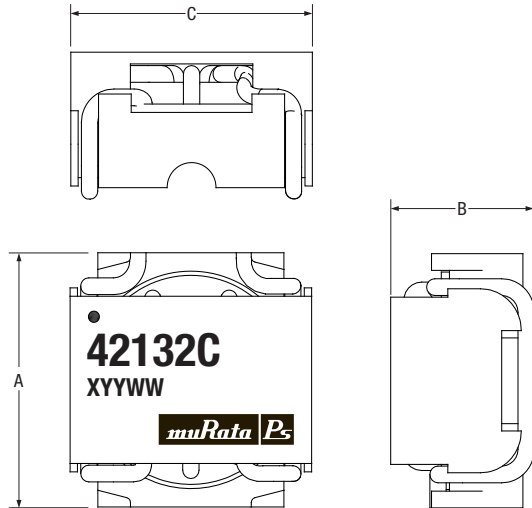

Package weight: See Selection Guide.

RECOMMENDED FOOTPRINT DETAILS

See Selection Guide for dimensions.

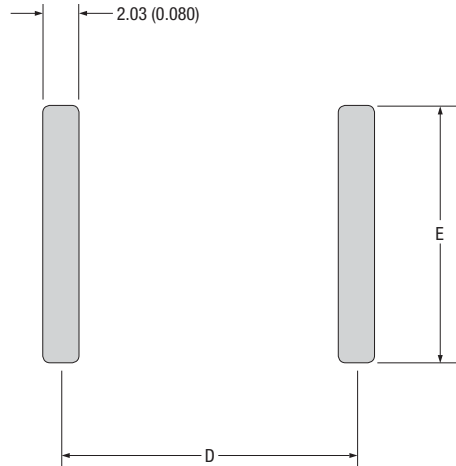

All dimensions in mm (inches).

TAPE & REEL SPECIFICATIONS

TAPE OUTLINE DIMENSIONS

See Selection Guide for dimensions.

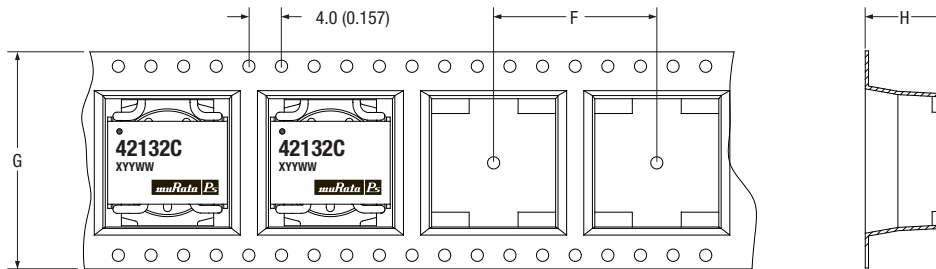

All dimensions in mm (inches).
See Selection Guide for package quantities.

Murata Power Solutions, Inc.
11 Cabot Boulevard, Mansfield, MA 02048-1151 U.S.A.
ISO 9001 and 14001 REGISTERED

Murata Power Solutions, Inc. makes no representation that the use of its products in the circuits described herein, or the use of other technical information contained herein, will not infringe upon existing or future patent rights. The descriptions contained herein do not imply the granting of licenses to make, use, or sell equipment constructed in accordance therewith. Specifications are subject to change without notice.
© 2018 Murata Power Solutions, Inc.

Mouser Electronics

Authorized Distributor

Click to View Pricing, Inventory, Delivery & Lifecycle Information:

[Murata:](#)

[42842C-R](#) [42183C](#) [42422C](#) [42103C-R](#) [42132C-R](#) [42282C](#) [42212C](#) [42842C](#) [42183C-R](#) [42132C](#) [42282C-R](#)
[42103C](#) [42652C-R](#) [42212C-R](#) [42652C](#) [42422C-R](#)