



SERIES RR 3130 SWITCHES

ROCKER SWITCHES



SPECIFICATIONS

Contact Rating: 10A @ 125VAC
6A @ 250VAC

Life Expectancy (Mechanical): 20,000 cycles

Life Expectancy (Electrical): 6,000 cycles

Contact Resistance: 50 mΩ (Initial Max.)

Insulation Resistance: 100M Ω @ 500V DC

Dielectric Strength: 1,500V Minimum (1 minute)

Operating Temp: 0°C to 65°C

MATERIALS

Material: UL94-V2

Termination: Solder lug, silver-plated

Panel Requirement: 6mm max. thickness, cut out per drawing

FEATURES & BENEFITS

- ▶ Ergonomic Euro design
- ▶ Panel mount
- ▶ Round design fits easily into your application

APPLICATIONS/MARKETS

- ▶ Industrial
- ▶ Lighting ballast
- ▶ Audio/visual
- ▶ Medical equipment
- ▶ Computer/servers/peripherals

HOW TO ORDER

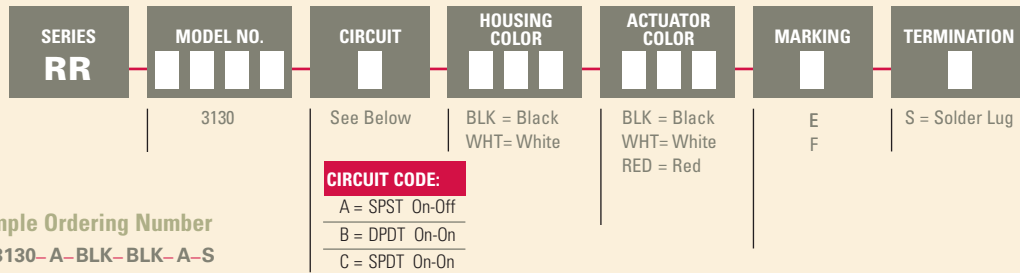

Example Ordering Number
RR-3130-A-BLK-BLK-A-S

Specifications subject to change without notice. 8.15.2018

RR 3130

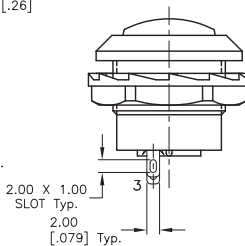
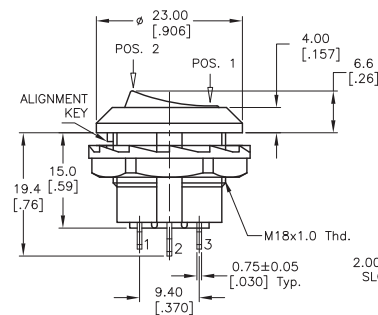
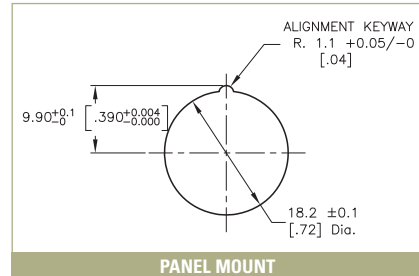
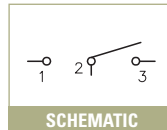
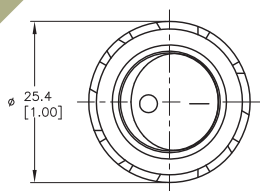

MARKING OPTIONS

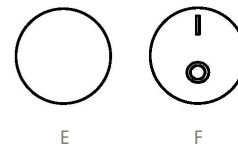

Mouser Electronics

Authorized Distributor

Click to View Pricing, Inventory, Delivery & Lifecycle Information:

[E-Switch:](#)

[RR3130CBLKBLKFS](#) [RR3130ABLKBLKFS](#) [RR3130CBLKBLKES](#) [RR3130ABLKREDFS](#)