

4

3

2

1

THIS DRAWING IS UNPUBLISHED. RELEASED FOR PUBLICATION
 © COPYRIGHT - By - ALL RIGHTS RESERVED.

LOC	DIST	REVISIONS			
P	LTR	DESCRIPTION	DATE	DWN	APVD
HB	-				
	H1	ADD NEW PN	ECO-18-004592	27-MAR-18	XR.L K.T

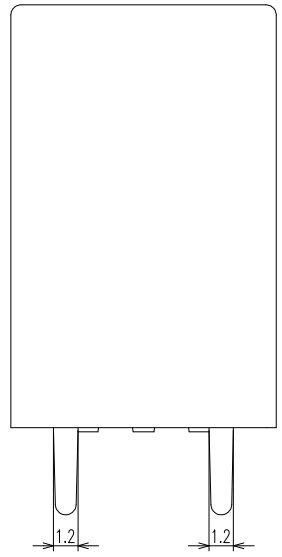
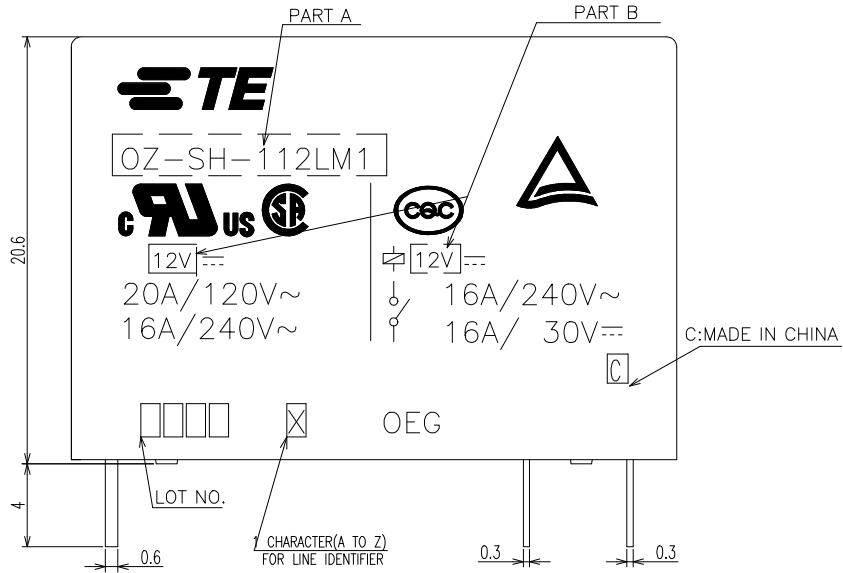
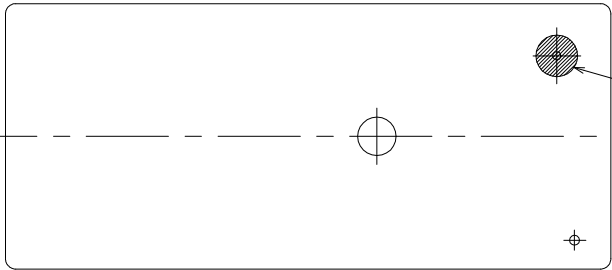

NOTES:
 1.TERMINAL DIMENSION IS NOT INCLUDING SOLDER TIP.
 2.LOT NO. SYSTEM AS FOLLOING:

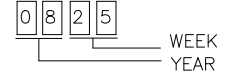

3.GENERAL TOLERANCE AS FOLLOING:

TOLERANCE	
0~0.99mm	±0.1
1mm~2.99mm	±0.2
3mm MIN.	±0.3

4.FOR THE TIN-PLATING OF THE PINS:
 +0.1mm FOR WIDTH,THICKNESS AND DIAMETER.
 +0.5mm FOR LENGTH.

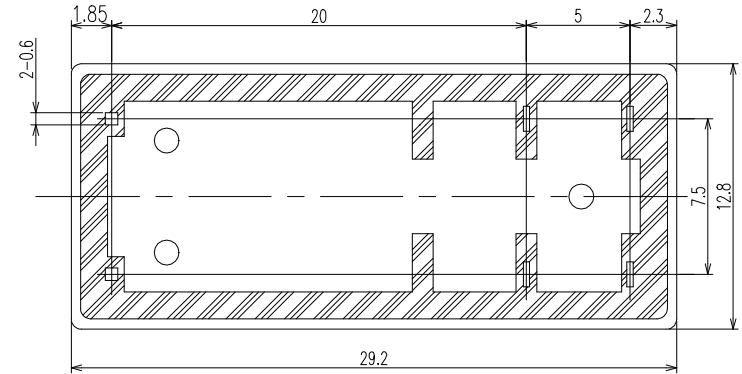

THIS DRAWING IS A CONTROLLED DOCUMENT.		DWN SHIMING.CHEN	TE TE Connectivity	
		CHK WAYNE.PENG		
DIMENSIONS: mm		APVD FUNAYAMA.NAOYA	NAME OZ-1M CUSTOMER DRAWING	
TOLERANCES UNLESS OTHERWISE SPECIFIED:		PRODUCT SPEC -	SIZE A3	
0 PLC ±-		APPLICATION SPEC -	CAGE CODE 00779	DRAWING NO C=1440002-5
1 PLC ±-		WEIGHT -	RESTRICTED TO -	
2 PLC ±-		CUSTOMER DRAWING		
3 PLC ±-		SCALE 4:1		
4 PLC ±-		SHEET 1 OF 2		
ANGLES ±-		REV H1		
FINISH -				

THIS DRAWING IS UNPUBLISHED.

RELEASED FOR PUBLICATION

© COPYRIGHT - By -

ALL RIGHTS RESERVED.

LOC

DIST

REVISIONS

HB

P	LTR	DESCRIPTION	DATE	DWN	APVD

(H)	PART NO	DESCRIPTION	PART B	PART A	ITEM
	2-1461250-0	OZ-SH-112LM1	12V	OZ-SH-112LM1	z
	1-1461250-4	OZ-SH-112DM1	12V	OZ-SH-112DM1	y
	1-1461250-9	OZ-SH-148LM1	48V	OZ-SH-148LM1	x
	1-1461250-7	OZ-SH-148DM1	48V	OZ-SH-148DM1	w
	1-1461250-5	OZ-SH-124LM1	24V	OZ-SH-124LM1	v
	1-1461250-3	OZ-SH-109LM1	9V	OZ-SH-109LM1	u
	1-1461250-1	OZ-SH-109DM1	9V	OZ-SH-109DM1	t
	0-1461250-9	OZ-SH-106LM1	6V	OZ-SH-106LM1	s
	0-1461250-7	OZ-SH-106DM1	6V	OZ-SH-106DM1	r
	0-1461250-4	OZ-SH-105DM1	5V	OZ-SH-105DM1	q
	0-1-1440002-0	OZ-SH-124DM1	24V	OZ-SH-124DM1	p
	0-1440002-8	OZ-SH-112LM1	12V	OZ-SH-112LM1	o
	0-1440002-5	OZ-SH-105LM1	5V	OZ-SH-105LM1	n
	7-1440009-5	OZ-SS-103LM1	3V	OZ-SS-103LM1	m
	0-1461355-1	OZ-SS-118DM1	18V	OZ-SS-118DM1	l
	0-1461251-5	OZ-SS-105DM1	5V	OZ-SS-105DM1	k
	0-1461251-4	OZ-SS-109DM1	9V	OZ-SS-109DM1	j
	0-1461251-3	OZ-SS-105LM1	5V	OZ-SS-105LM1	i
	3-1440002-0	OZ-SS-148DM1	48V	OZ-SS-148DM1	h
	2-1440002-9	OZ-SS-124LM1	24V	OZ-SS-124LM1	g
	2-1440002-6	OZ-SS-124DM1	24V	OZ-SS-124DM1	f
	2-1440002-4	OZ-SS-112LM1	12V	OZ-SS-112LM1	e
	2-1440002-2	OZ-SS-112DM1	12V	OZ-SS-112DM1	d
	2-1440002-0	OZ-SS-109LM1	9V	OZ-SS-109LM1	c
	1-1440002-7	OZ-SS-106LM1	6V	OZ-SS-106LM1	b
	1-1440002-5	OZ-SS-106DM1	6V	OZ-SS-106DM1	a

RELAY TYPE

DRILLING DIAGRAM (BOTTOM VIEW)

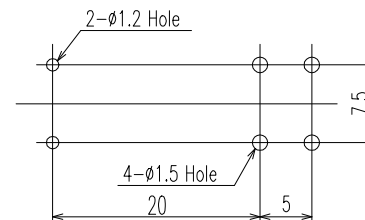

CIRCUIT DIAGRAM(2/1) (BOTTOM VIEW)

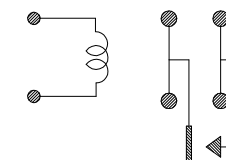

INCOMBUSTIBILITY	TREATMENT	MATERIAL	DESCRIPTION	ITEM
		UV RESIN	UV SEAL	16
		EPOXY RESIN	SEAL	15
		Cu ALLOY	HINGE SPRING	14
		PBT/PA66	CASE	13
		MW79	MAGNETIC WIRE	12
UL94V-0		PET	BASE	11
UL94HB		PBT	BOBBIN	10
	SOLDER DIP	Cu ALLOY	COIL TERMINAL	9
UL94V-0		PPS	CARD	8
		Ag ALLOY	MOVABLE CONTACT	7
		Ag ALLOY	STATIONARY CONTACT	6
	SOLDER DIP	Cu ALLOY	MOVABLE SPRING	5
	SOLDER DIP	Cu ALLOY	NO-TERMINAL	4
		Ni PLATED STEEL	CORE	3
		Ni PLATED STEEL	ARMATURE	2
		Ni PLATED STEEL	YOKE	1

THIS DRAWING IS A CONTROLLED DOCUMENT.

DWN: -
CHK: -
APVD: -
PRODUCT SPEC: -
APPLICATION SPEC: -
WEIGHT: -

DIMENSIONS: mm
TOLERANCES UNLESS OTHERWISE SPECIFIED:
0 PLC ±-
1 PLC ±-
2 PLC ±-
3 PLC ±-
4 PLC ±-
ANGLES ±-

MATERIAL: -
FINISH: -

STE TE Connectivity

NAME: OZ-1M CUSTOMER DRAWING

SIZE: A3
CAGE CODE: 00779
DRAWING NO: 1440002-5
RESTRICTED TO: -

CUSTOMER DRAWING SCALE: 4:1 SHEET: 2 OF 2 REV: H1