

AYZ Series Miniature Slide Switches



Features/Benefits

- Low profile
- Single & double pole models
- Double & triple throw models
- RoHS compatible

Typical Applications

- Computer peripherals & network products
- Telecommunication products
- Test & measurement equipment

Specifications

MAX. SWITCHING POWER: 1.2 VA
 MAX. SWITCHING VOLTAGE: 12 VDC
 MAX. SWITCHING CURRENT: 100 mA
 MECHANICAL LIFE: 10,000 operations.
 CONTACT RESISTANCE: <math><80\text{m}\Omega</math>
 INSULATION RESISTANCE: >10 Ω
 DIELECTRIC STRENGTH: 0.1 kV at 50 Hz/1 min.
 OPERATING TEMPERATURE: -10°C to +60°C
 PACKAGING: Tape & reel, see page I-47.

Materials

HOUSING: Glass filled nylon 4/6 (UL 94V-0).
 ACTUATOR: Glass filled nylon 6/6 (UL 94V-0), except options ending in C which are glass filled nylon 4/6 (UL94V-0).
 COVER: Nickel silver.
 MOVABLE CONTACT: Copper alloy, silver plated.
 FIXED CONTACT: Brass, silver plated.
 CONTACT SPRING: Contact bronze.

NOTE: Specifications and materials listed above are for switches with standard options. For information on specific and custom switches, consult Customer Service Center.

How To Order

Complete part numbers for AYZ Series Miniature Slide Switches are shown on pages I-46 through I-48.

PC MOUNTING

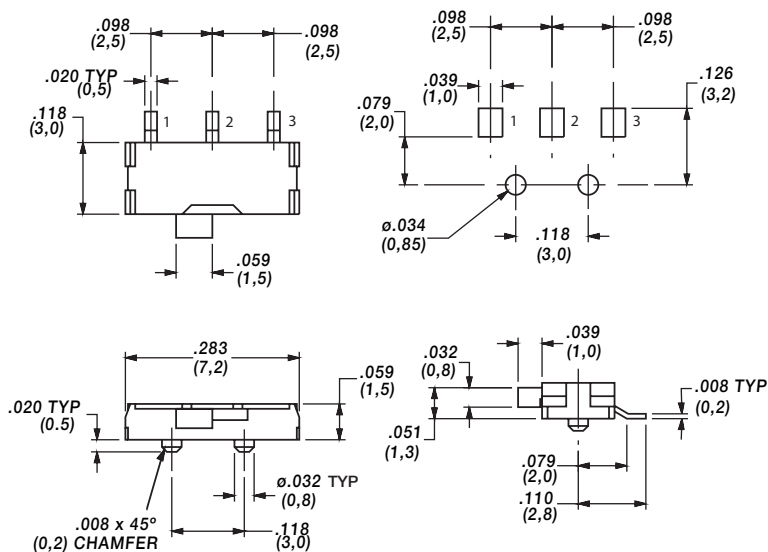

SWITCH SHOWN IN POSITION 1

PART NUMBER	RoHS		SWITCH FUNCTION	
	Compliant	Compatible	POS.1	POS.2
AYZ0102AGRLC	YES	YES		
CONN. TERMINALS			1-2	2-3
SCHEMATIC				
SPDT				



Dimensions are shown: Inch (mm)
 Specifications and dimensions subject to change



Slide

AYZ Series Miniature Slide Switches

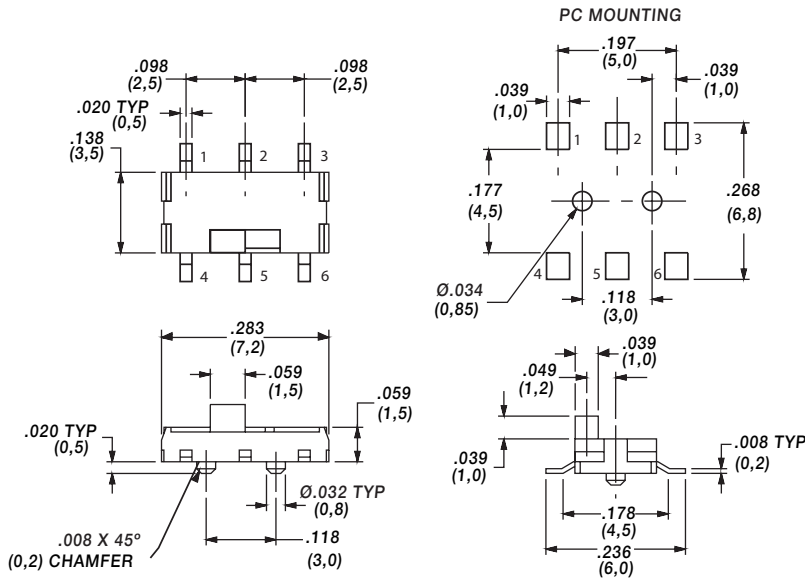

SWITCH SHOWN IN POSITION 1

PART NUMBER	SWITCH FUNCTION	
	POS.1	POS.2
AYZ0202AGRLC	ON	ON
CONN. TERMINALS	1-2,4-5	2-3,5-6
SCHEMATIC		
DPDT		

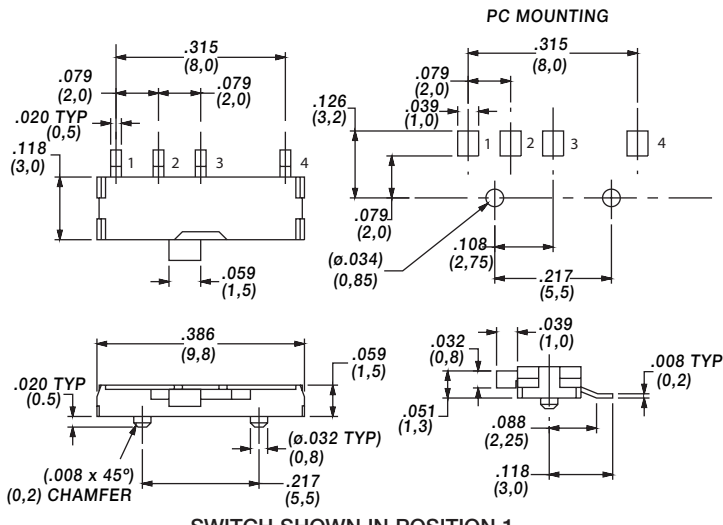

SWITCH SHOWN IN POSITION 1

PART NUMBER	SWITCH FUNCTION		
	POS.1	POS.2	POS.3
AYZ0103AGRLC	ON	ON	ON
CONN. TERMINALS	1-3	2-C	3-4
SCHEMATIC			
SP3T			

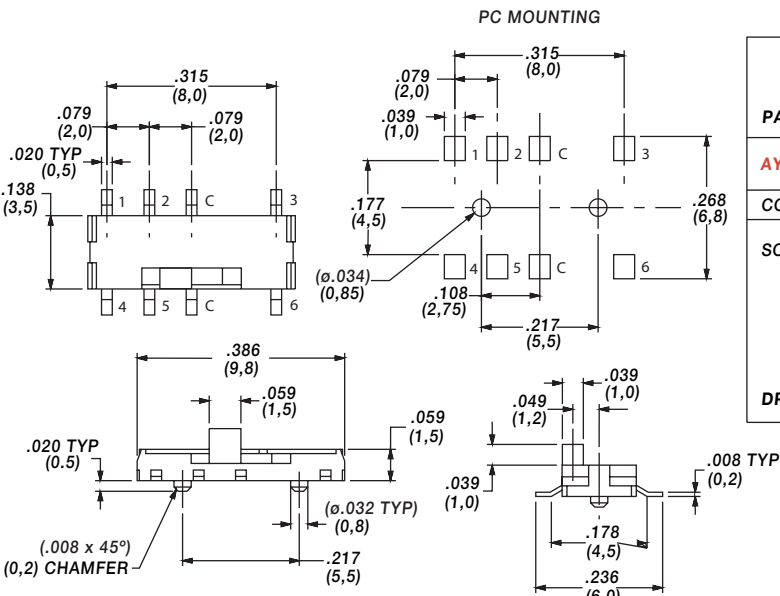

SWITCH SHOWN IN POSITION 1

PART NUMBER	SWITCH FUNCTION		
	POS.1	POS.2	POS.3
AYZ0203AGRLC	ON	ON	ON
CONN. TERMINALS	1-C,4-C	2-C,5-C	3-C,6-C
SCHEMATIC			
DP3T			



Dimensions are shown: Inches (mm)
Specifications and dimensions subject to change



AYZ Series Miniature Slide Switches

TAPE & REEL

For part number AYZ0102AGRLC

Quantity per reel 4000

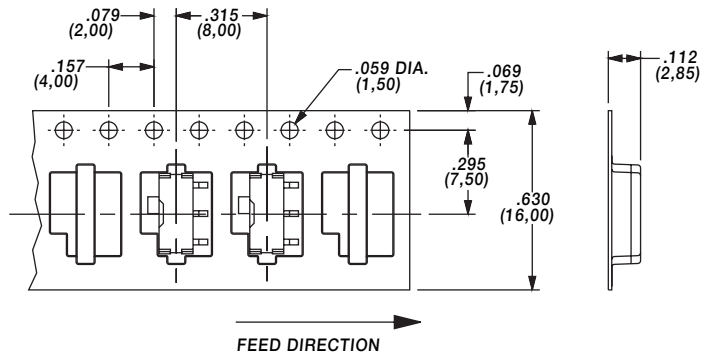

For part number AYZ0103AGRLC

Quantity per reel 4000

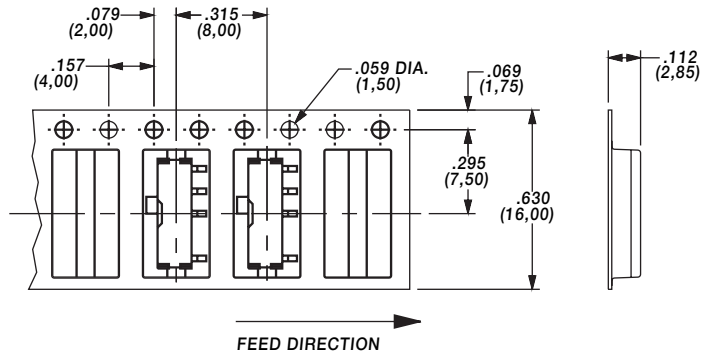

For part number AYZ0202AGRLC

Quantity per reel 3000

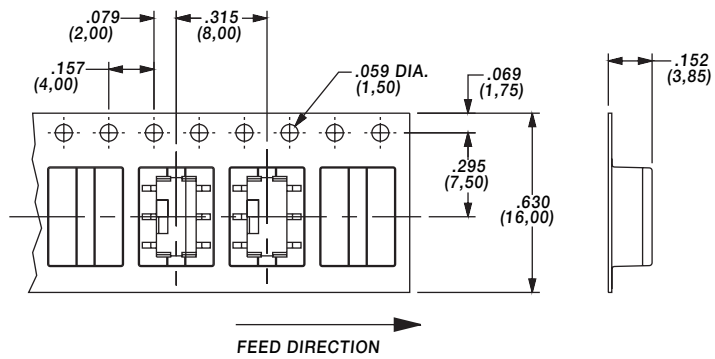

For part number AYZ0203AGRLC

Quantity per reel 3000

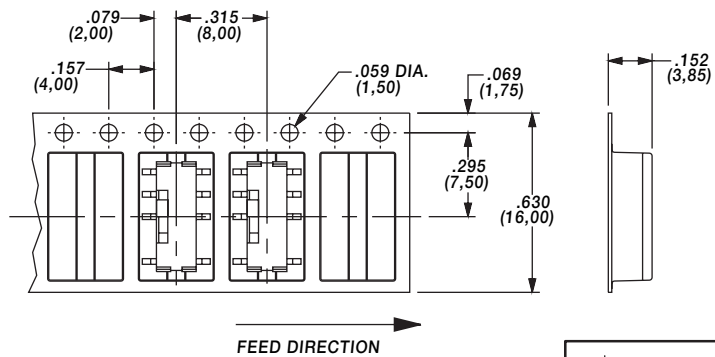

Dimensions are shown: Inch (mm)
Specifications and dimensions subject to change



Mouser Electronics

Authorized Distributor

Click to View Pricing, Inventory, Delivery & Lifecycle Information:

C&K Switches:

[AYZ0202AGRLC](#) [AYZ0103AGRLC](#) [AYZ0203AGRLC](#) [AYZ0102AGRLC](#)