

PRODUCT NUMBER
SEE TABLE

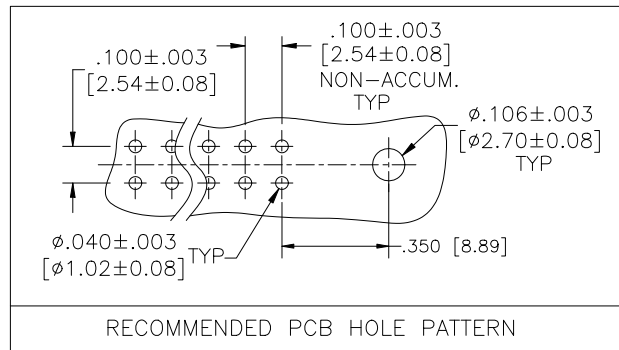
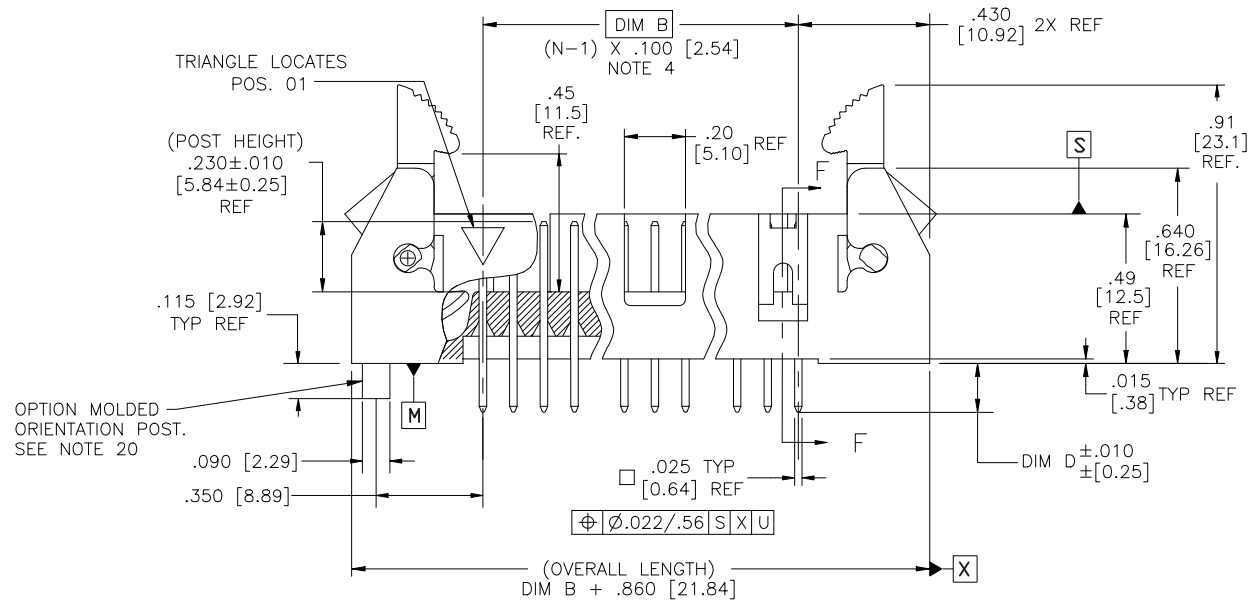
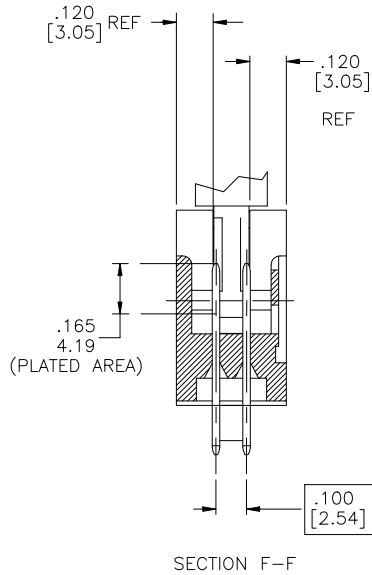
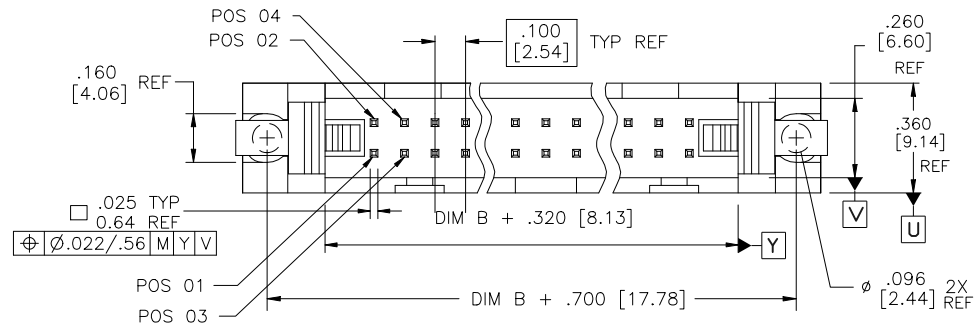

mat'l. code		surface ISO 1302 ✓		tolerance ISO 406 ISO 1101		projection MM		product family QUICKIE	
ltr		ecn no		dr		date		title	
BA		N08-0073		Bobby S		4/28/08		HEADER, QUICKIE	
BB		N09-0007		R.B		2009/01/12		SEA-HORSE, VERTICAL	
BC		ELX-N-012097		J.Z		2012-07-04		scale 1:1	
BD		ELX-N-13354		DCS		2012-11-02		dr M. CORNMAN 8/21/90	
BE		ELX-N-17979		TIM		2014-06-17		engr M. SMYK 8/21/90	
BF		ELX-N-24312		MZ		2016-06-17		chr M. SMYK 8/21/90	
BG		ELX-N-25774		MZ		2016-12-28		appd M. SMYK 8/21/90	
sheet		revision		BG		BG		BG	
index		sheet		1		2		3	
				4		5		6	
				7		8		9	
				10		11		12	
				13		14		15	
				16		17		18	
				19		20		21	
				22		23		24	

Amphenol FCI

© 2016 AFCI

PRODUCT NO NOTE 12,13	SIZE	LATCH NOTE 8	DIM B	DIM D	TERMINAL PLATING	STYLE
65863-001	2x5	NO	.400/10,160	.105/ 2,67	30u"/0.76u MIN (NOTE 17) OVER 50u"/1.27u Ni	A
-002				.105/ 2,67	120u"~200u"/3.04um~5.08umTIN/LEAD	
-003				.150/ 3,81	30u"/0.76u MIN (NOTE 17) OVER 50u"/1.27u Ni	
-004				.150/ 3,81	120u"~200u"/3.04um~5.08umTIN/LEAD	
-005				.675/17,15	30u"/0.76u MIN (NOTE 17) OVER 50u"/1.27u Ni	
-006	2x5		.400/10,160	.675/17,15	120u"~200u"/3.04um~5.08umTIN/LEAD	A
-007	2x7		.600/15,240	.105/ 2,67	30u"/0.76u MIN (NOTE 17) OVER 50u"/1.27u Ni	C
-008				.105/ 2,67	120u"~200u"/3.04um~5.08umTIN/LEAD	
-009				.150/ 3,81	30u"/0.76u MIN (NOTE 17) OVER 50u"/1.27u Ni	
-010				.150/ 3,81	120u"~200u"/3.04um~5.08umTIN/LEAD	
-011				.675/17,15	30u"/0.76u MIN (NOTE 17) OVER 50u"/1.27u Ni	
-012	2x7		.600/15,240	.675/17,15	120u"~200u"/3.04um~5.08umTIN/LEAD	C
-013	2x8		.700/17,780	.105/ 2,67	30u"/0.76u MIN (NOTE 17) OVER 50u"/1.27u Ni	D
-014				.105/ 2,67	120u"~200u"/3.04um~5.08umTIN/LEAD	
-015				.150/ 3,81	30u"/0.76u MIN (NOTE 17) OVER 50u"/1.27u Ni	
-016				.150/ 3,81	120u"~200u"/3.04um~5.08umTIN/LEAD	
-017				.675/17,15	30u"/0.76u MIN (NOTE 17) OVER 50u"/1.27u Ni	
-018	2x8		.700/17,780	.675/17,15	120u"~200u"/3.04um~5.08umTIN/LEAD	
-019	2x10		.900/22,860	.105/ 2,67	30u"/0.76u MIN (NOTE 17) OVER 50u"/1.27u Ni	
-020				.105/ 2,67	120u"~200u"/3.04um~5.08umTIN/LEAD	
-021				.150/ 3,81	30u"/0.76u MIN (NOTE 17) OVER 50u"/1.27u Ni	
-022				.150/ 3,81	120u"~200u"/3.04um~5.08umTIN/LEAD	
-023				.675/17,15	30u"/0.76u MIN (NOTE 17) OVER 50u"/1.27u Ni	
-024	2x10		.900/22,860	.675/17,15	120u"~200u"/3.04um~5.08umTIN/LEAD	
-025	2x13		1.200/30,480	.105/ 2,67	30u"/0.76u MIN (NOTE 17) OVER 50u"/1.27u Ni	
-026				.105/ 2,67	120u"~200u"/3.04um~5.08umTIN/LEAD	
-027				.150/ 3,81	30u"/0.76u MIN (NOTE 17) OVER 50u"/1.27u Ni	
-028				.150/ 3,81	120u"~200u"/3.04um~5.08umTIN/LEAD	
-029				.675/17,15	30u"/0.76u MIN (NOTE 17) OVER 50u"/1.27u Ni	
-030	2x13		1.200/30,480	.675/17,15	120u"~200u"/3.04um~5.08umTIN/LEAD	
-031	2x17		1.600/40,640	.105/ 2,67	30u"/0.76u MIN (NOTE 17) OVER 50u"/1.27u Ni	
-032				.105/ 2,67	120u"~200u"/3.04um~5.08umTIN/LEAD	
-033				.150/ 3,81	30u"/0.76u MIN (NOTE 17) OVER 50u"/1.27u Ni	
-034				.150/ 3,81	120u"~200u"/3.04um~5.08umTIN/LEAD	
-035				.675/17,15	30u"/0.76u MIN (NOTE 17) OVER 50u"/1.27u Ni	
65863-036	2x17	NO	1.600/40,640	.675/17,15	120u"~200u"/3.04um~5.08umTIN/LEAD	D

mat'l. code		surface ISO 1302 ✓		tolerance ISO 406 ISO 1101		projection 		product family QUICKIE	
ltr ecn no dr date		tolerances unless otherwise specified		angles linear				title HEADER, QUICKIE SEA-HORSE, VERTICAL	
BG				.xxx±.01/.xx±0.3		scale 1:1		dwg no sheet 3 of 23 size	
				.xxx±.005/.xxx±0.13		Amphenol FCI		65863 A3	
				.xxx±.0020 .xxx±0.051				type Product Customer Drawing	
		dr M. CORNMAN 8/21/90							
		enr M. SMYK 8/21/90							
		chr M. SMYK 8/21/90							
		appd M. SMYK 8/21/90							
sheet index		revision sheet							

Amphenol FCI

© 2016 AFCI

PRODUCT NO NOTE 12,13	SIZE	LA ICH NOTE 8	DIM B	DIM D	TERMINAL PLATING	STYLE
65863-037	2x20	NO	1.900/48,260	.105/ 2,67	30u"/0.76u MIN (NOTE 17) OVER 50u"/1.27u Ni	D
-038				.105/ 2,67	120u"~200u"/3.04um~5.08umTIN/LEAD	NOTE 16,19
-039				.150/ 3,81	30u"/0.76u MIN (NOTE 17) OVER 50u"/1.27u Ni	
-040				.150/ 3,81	120u"~200u"/3.04um~5.08umTIN/LEAD	NOTE 16,19
-041				.675/17,15	30u"/0.76u MIN (NOTE 17) OVER 50u"/1.27u Ni	
-042	2x20		1.900/48,260	.675/17,15	120u"~200u"/3.04um~5.08umTIN/LEAD	NOTE 16,19
-043	2x25		2.400/60,960	.105/ 2,67	30u"/0.76u MIN (NOTE 17) OVER 50u"/1.27u Ni	
-044				.105/ 2,67	120u"~200u"/3.04um~5.08umTIN/LEAD	NOTE 16,19
-045				.150/ 3,81	30u"/0.76u MIN (NOTE 17) OVER 50u"/1.27u Ni	
-046				.150/ 3,81	120u"~200u"/3.04um~5.08umTIN/LEAD	NOTE 16,19
-047				.675/17,15	30u"/0.76u MIN (NOTE 17) OVER 50u"/1.27u Ni	
-048	2x25	NO	2.400/60,960	.675/17,15	120u"~200u"/3.04um~5.08umTIN/LEAD	D
-049	2x5	STD	.400/10,160	.105/ 2,67	30u"/0.76u MIN (NOTE 17) OVER 50u"/1.27u Ni	A
-050				.105/ 2,67	120u"~200u"/3.04um~5.08umTIN/LEAD	NOTE 16,19
-051				.150/ 3,81	30u"/0.76u MIN (NOTE 17) OVER 50u"/1.27u Ni	
-052				.150/ 3,81	120u"~200u"/3.04um~5.08umTIN/LEAD	NOTE 16,19
-053				.675/17,15	30u"/0.76u MIN (NOTE 17) OVER 50u"/1.27u Ni	
-054	2x5		.400/10,160	.675/17,15	120u"~200u"/3.04um~5.08umTIN/LEAD	A
-055	2x7		.600/15,240	.105/ 2,67	30u"/0.76u MIN (NOTE 17) OVER 50u"/1.27u Ni	C
-056				.105/ 2,67	120u"~200u"/3.04um~5.08umTIN/LEAD	NOTE 16,19
-057				.150/ 3,81	30u"/0.76u MIN (NOTE 17) OVER 50u"/1.27u Ni	
-058				.150/ 3,81	120u"~200u"/3.04um~5.08umTIN/LEAD	NOTE 16,19
-059				.675/17,15	30u"/0.76u MIN (NOTE 17) OVER 50u"/1.27u Ni	
-060	2x7		.600/15,240	.675/17,15	120u"~200u"/3.04um~5.08umTIN/LEAD	C
-061	2x8		.700/17,780	.105/ 2,67	30u"/0.76u MIN (NOTE 17) OVER 50u"/1.27u Ni	D
-062				.105/ 2,67	120u"~200u"/3.04um~5.08umTIN/LEAD	NOTE 16,19
-063				.150/ 3,81	30u"/0.76u MIN (NOTE 17) OVER 50u"/1.27u Ni	
-064				.150/ 3,81	120u"~200u"/3.04um~5.08umTIN/LEAD	NOTE 16,19
-065				.675/17,15	30u"/0.76u MIN (NOTE 17) OVER 50u"/1.27u Ni	
-066	2x8		.700/17,780	.675/17,15	120u"~200u"/3.04um~5.08umTIN/LEAD	NOTE 16,19
-067/-067PC	2x10		.900/22,860	.105/ 2,67	30u"/0.76u MIN (NOTE 17) OVER 50u"/1.27u Ni	NOTE 22
-068				.105/ 2,67	120u"~200u"/3.04um~5.08umTIN/LEAD	NOTE 16,19
-069				.150/ 3,81	30u"/0.76u MIN (NOTE 17) OVER 50u"/1.27u Ni	
-070				.150/ 3,81	120u"~200u"/3.04um~5.08umTIN/LEAD	NOTE 16,19
-071				.675/17,15	30u"/0.76u MIN (NOTE 17) OVER 50u"/1.27u Ni	
65863-072	2x10	STD	.900/22,860	.675/17,15	120u"~200u"/3.04um~5.08umTIN/LEAD	D

mat'l. code		surface	tolerance	projection	product family
ISO 1302		ISO 406	ISO 1101		QUICKIE
ltr		tolerances unless otherwise specified		title	
ecn no	dr	.XX±.01/.X±0.3		HEADER, QUICKIE	
dr	date	.XXX±.005/.XXX±0.13		SEA-HORSE, VERTICAL	
dr	date	.XXX±.0020/.XXX±0.051		dwg no	
enr	date	linear		sheet 4 of 23 size	
chr	date	0±2°		65863	
appd	date	MM		A3	
sheet		scale 1:1		type Product Customer Drawing	
index	revision	Amphenol FCI			
sheet	sheet				

Amphenol FCI

© 2016 AFCI

PRODUCT NO NOTES 12,13	SIZE	LA ICH NOTE 8	DIM B	DIM D	TERMINAL PLATING	STYLE
65863-073/-073PC	2x13	STD	1.200/30,480	.105/ 2,67	30u"/0.76u MIN (NOTE 17) OVER 50u"/1.27u Ni	D
-074				.105/ 2,67	120u"~200u"/3.04um~5.08umTIN/LEAD	
-075				.150/ 3,81	30u"/0.76u MIN (NOTE 17) OVER 50u"/1.27u Ni	
-076				.150/ 3,81	120u"~200u"/3.04um~5.08umTIN/LEAD	
-077				.675/17,15	30u"/0.76u MIN (NOTE 17) OVER 50u"/1.27u Ni	
-078	2x13		1.200/30,480	.675/17,15	120u"~200u"/3.04um~5.08umTIN/LEAD	
-079/-079PC	2x17		1.600/40,640	.105/ 2,67	30u"/0.76u MIN (NOTE 17) OVER 50u"/1.27u Ni	
-080				.105/ 2,67	120u"~200u"/3.04um~5.08umTIN/LEAD	
-081				.150/ 3,81	30u"/0.76u MIN (NOTE 17) OVER 50u"/1.27u Ni	
-082				.150/ 3,81	120u"~200u"/3.04um~5.08umTIN/LEAD	
-083				.675/17,15	30u"/0.76u MIN (NOTE 17) OVER 50u"/1.27u Ni	
-084	2x17		1.600/40,640	.675/17,15	120u"~200u"/3.04um~5.08umTIN/LEAD	
-085/-085PC	2x20		1.900/48,260	.105/ 2,67	30u"/0.76u MIN (NOTE 17) OVER 50u"/1.27u Ni	
-086				.105/ 2,67	120u"~200u"/3.04um~5.08umTIN/LEAD	
-087				.150/ 3,81	30u"/0.76u MIN (NOTE 17) OVER 50u"/1.27u Ni	
-088				.150/ 3,81	120u"~200u"/3.04um~5.08umTIN/LEAD	
-089				.675/17,15	30u"/0.76u MIN (NOTE 17) OVER 50u"/1.27u Ni	
-090	2x20		1.900/48,260	.675/17,15	120u"~200u"/3.04um~5.08umTIN/LEAD	
-091	2x25		2.400/60,960	.105/ 2,67	30u"/0.76u MIN (NOTE 17) OVER 50u"/1.27u Ni	
-092				.105/ 2,67	120u"~200u"/3.04um~5.08umTIN/LEAD	
-093				.150/ 3,81	30u"/0.76u MIN (NOTE 17) OVER 50u"/1.27u Ni	
-094				.150/ 3,81	120u"~200u"/3.04um~5.08umTIN/LEAD	
-095				.675/17,15	30u"/0.76u MIN (NOTE 17) OVER 50u"/1.27u Ni	
-096	2x25	STD	2.400/60,960	.675/17,15	120u"~200u"/3.04um~5.08umTIN/LEAD	
-097	2x30	NO	2.900/73,660	.105/ 2,67	30u"/0.76u MIN (NOTE 17) OVER 50u"/1.27u Ni	
-098				.105/ 2,67	120u"~200u"/3.04um~5.08umTIN/LEAD	
-099				.150/ 3,81	30u"/0.76u MIN (NOTE 17) OVER 50u"/1.27u Ni	
-100				.150/ 3,81	120u"~200u"/3.04um~5.08umTIN/LEAD	
-101				.675/17,15	30u"/0.76u MIN (NOTE 17) OVER 50u"/1.27u Ni	
-102		NO		.675/17,15	120u"~200u"/3.04um~5.08umTIN/LEAD	
-103		STD		.105/ 2,67	30u"/0.76u MIN (NOTE 17) OVER 50u"/1.27u Ni	
-104				.105/ 2,67	120u"~200u"/3.04um~5.08umTIN/LEAD	
-105				.150/ 3,81	30u"/0.76u MIN (NOTE 17) OVER 50u"/1.27u Ni	
-106				.150/ 3,81	120u"~200u"/3.04um~5.08umTIN/LEAD	
-107				.675/17,15	30u"/0.76u MIN (NOTE 17) OVER 50u"/1.27u Ni	
65863-108	2x30	STD	2.900/73,660	.675/17,15	120u"~200u"/3.04um~5.08umTIN/LEAD	D

mat'l. code		surface	tolerance	projection	product family
ISO 1302		ISO 1302	ISO 1101		QUICKIE
ltr		ecn no	dr	title	
BG				HEADER, QUICKIE SEA-HORSE, VERTICAL	
angles		linear		MM	
0±2°		.XX±.01/XX±0.3 .XXX±.005/XXX±0.13 .XXX±.0020 .XXX±0.051		scale 1:1	
dr		M. CORNMAN		8/21/90	
enr		M. SMYK		8/21/90	
chr		M. SMYK		8/21/90	
appd		M. SMYK		8/21/90	
sheet		revision		type Product Customer Drawing	
index		sheet			

Amphenol FCI

© 2016 AFCI

PRODUCT NO NOTE 12,13	SIZE	LATCH NOTE 8	DIM B	DIM D	TERMINAL PLATING	STYLE
5863-109	2x5	NO	.400/10,160	.105/ 2,67	30u"/0.76u MIN (NOTE 17) OVER 50u"/1.27u Ni	A
-110	2x7		.600/15,240			C
-111	2x8		.700/17,780			D
-112	2x10		.900/22,860			
-113	2x13		1.200/30,480			
-114	2x17		1.600/40,640			
-115	2x20		1.900/48,260			
-116	2x25		2.400/60,960			
-117	2x30	NO	2.900/73,660			D
-118	2x5	STD	.400/10,160			A
-119	2x7		.600/15,240			C
-120	2x8		.700/17,780			D
-121	2x10		.900/22,860			
-122	2x13		1.200/30,480			
-123	2x17		1.600/40,640			
-124	2x20		1.900/48,260			
-125	2x25		2.400/60,960			
-126	2x30	STD	2.900/73,660	.105/ 2,67		
-127	2x20	NO	1.900/48,260	.150/ 3,81		
-128	2x20	STD	1.900/48,260			D
-129	2x5	NO	.400/10,160			A
-130	2x7		.600/15,240			C
-131	2x8		.700/17,780			D
-132	2x10		.900/22,860			
-133	2x13		1.200/30,480			
-134	2x17		1.600/40,640			
-135	2x20		1.900/48,260			
-136	2x25		2.400/60,960			
-137	2x30	NO	2.900/73,660			D
-138	2x5	STD	.400/10,160			A
-139	2x7		.600/15,240			C
-140	2x8		.700/17,780			D
-141	2x10		.900/22,860			
-142	2x13		1.200/30,480			
-143	2x17		1.600/40,640			
5863-144	2x20	STD	1.900/48,260	.150/ 3,81	30u"/0.76u MIN (NOTE 17) OVER 50u"/1.27u Ni	D

Amphenol FCI

© 2016 AFCI

©

©

D

mat'l. code		surface <input checked="" type="checkbox"/> ISO 1302	tolerance <input checked="" type="checkbox"/> ISO 406	projection	product family QUICKIE
ltr		tolerances unless otherwise specified		MM	title HEADER, QUICKIE SEA-HORSE, VERTICAL
ecn no	dr	angles	linear		
BG				scale 1:1	
					dwg no
		dr	M. CORNMAN	8/21/90	sheet 6 of 23
		enr	M. SMYK	8/21/90	size
		chr	M. SMYK	8/21/90	65863
		appd	M. SMYK	8/21/90	A3
sheet index		revision sheet		type Product Customer Drawing	

PRODUCT NO NOTE 12,13	SIZE	LA ICH NOTE 8	DIM B	DIM D	TERMINAL PLATING	STYLE
65863-145	2x25	STD	2.400/60,960	.150/ 3,81	30u"/0.76u MIN (NOTE 17) OVER 50u"/1.27u Ni	D
-146	2x30	STD	2.900/73,660	.150/ 3,81	30u"/0.76u MIN (NOTE 17) OVER 50u"/1.27u Ni	D
-147	2x5	NO	.400/10,160	.675/17,15	15u"/0.38u MIN (NOTE 17) OVER 50u"/1.27u Ni	A
-148	2x7		.600/15,240			C
-149	2x8		.700/17,780			D
-150	2x10		.900/22,860			
-151	2x13		1.200/30,480			
-152	2x17		1.600/40,640			
-153	2x20		1.900/48,260			
-154	2x25		2.400/60,960			
-155	2x30	NO	2.900/73,660			D
-156	2x5	STD	.400/10,160			A
-157	2x7		.600/15,240			C
-158	2x8		.700/17,780			D
-159	2x10		.900/22,860			
-160	2x13		1.200/30,480			
-161	2x17		1.600/40,640			
-162	2x20		1.900/48,260			
-163	2x25		2.400/60,960			
-164	2x30	STD	2.900/73,660	.675/17,15	15u"/0.38u MIN (NOTE 17) OVER 50u"/1.27u Ni	D
-165	2x5	LP	.400/10,160	.105/ 2,67	30u"/0.76u MIN (NOTE 17) OVER 50u"/1.27u Ni	A
-166				.105/ 2,67	120u"~200u"/3.04um~5.08umTIN/LEAD	NOTE 16,19
-167				.150/ 3,81	30u"/0.76u MIN (NOTE 17) OVER 50u"/1.27u Ni	NOTE 16,19
-168				.150/ 3,81	120u"~200u"/3.04um~5.08umTIN/LEAD	NOTE 16,19
-169				.675/17,15	30u"/0.76u MIN (NOTE 17) OVER 50u"/1.27u Ni	NOTE 16,19
-170	2x5		.400/10,160	.675/17,15	120u"~200u"/3.04um~5.08umTIN/LEAD	NOTE 16,19
-171	2x7		.600/15,240	.105/ 2,67	30u"/0.76u MIN (NOTE 17) OVER 50u"/1.27u Ni	C
-172				.105/ 2,67	120u"~200u"/3.04um~5.08umTIN/LEAD	NOTE 16,19
-173				.150/ 3,81	30u"/0.76u MIN (NOTE 17) OVER 50u"/1.27u Ni	NOTE 16,19
-174				.150/ 3,81	120u"~200u"/3.04um~5.08umTIN/LEAD	NOTE 16,19
-175				.675/17,15	30u"/0.76u MIN (NOTE 17) OVER 50u"/1.27u Ni	NOTE 16,19
-176	2x7		.600/15,240	.675/17,15	120u"~200u"/3.04um~5.08umTIN/LEAD	C
-177	2x8		.700/17,780	.105/ 2,67	30u"/0.76u MIN (NOTE 17) OVER 50u"/1.27u Ni	D
-178	2x8		.700/17,780	.105/ 2,67	120u"~200u"/3.04um~5.08umTIN/LEAD	NOTE 16,19
-179	2x8		.700/17,780	.150/ 3,81	30u"/0.76u MIN (NOTE 17) OVER 50u"/1.27u Ni	D
65863-180	2x8	LP	.700/17,780	.150/ 3,81	120u"~200u"/3.04um~5.08umTIN/LEAD	NOTE 16,19

mat'l. code		surface	tolerance	projection	product family
ISO 1302		ISO 406	ISO 1101		QUICKIE
ltr		ecn no		title	
dr		date		HEADER, QUICKIE	
BG				SEA-HORSE, VERTICAL	
		angles	linear	MM	
		0±2°	linear	scale 1:1	
		dr	M. CORNMAN	8/21/90	dwg no
		enr	M. SMYK	8/21/90	sheet 7 of 23
		chr	M. SMYK	8/21/90	size
		appd	M. SMYK	8/21/90	65863
				type Product Customer Drawing	
sheet	revision				
index	sheet				

Amphenol FCI

© 2016 AFCI

PRODUCT NO NOTE 12,13	SIZE	LATCH NOTE 8	DIM B	DIM D	TERMINAL PLATING	STYLE
65863-181	2x8	LP	.700/17,780	.675/17,15	30u"/0.76u MIN (NOTE 17) OVER 50u"/1.27u Ni	D
-182	2x8		.700/17,780	.675/17,15	120u"~200u"/3.04um~5.08umTIN/LEAD	NOTE 16,19
-183	2x10		.900/22,860	.105/ 2,67	30u"/0.76u MIN (NOTE 17) OVER 50u"/1.27u Ni	
-184				.105/ 2,67	120u"~200u"/3.04um~5.08umTIN/LEAD	NOTE 16,19
-185				.150/ 3,81	30u"/0.76u MIN (NOTE 17) OVER 50u"/1.27u Ni	
-186				.150/ 3,81	120u"~200u"/3.04um~5.08umTIN/LEAD	NOTE 16,19
-187				.675/17,15	30u"/0.76u MIN (NOTE 17) OVER 50u"/1.27u Ni	
-188	2x10		.900/22,860	.675/17,15	120u"~200u"/3.04um~5.08umTIN/LEAD	NOTE 16,19
-189	2x13		1.200/30,480	.105/ 2,67	30u"/0.76u MIN (NOTE 17) OVER 50u"/1.27u Ni	
-190				.105/ 2,67	120u"~200u"/3.04um~5.08umTIN/LEAD	NOTE 16,19
-191				.150/ 3,81	30u"/0.76u MIN (NOTE 17) OVER 50u"/1.27u Ni	
-192				.150/ 3,81	120u"~200u"/3.04um~5.08umTIN/LEAD	NOTE 16,19
-193				.675/17,15	30u"/0.76u MIN (NOTE 17) OVER 50u"/1.27u Ni	
-194	2x13		1.200/30,480	.675/17,15	120u"~200u"/3.04um~5.08umTIN/LEAD	NOTE 16,19
-195	2x17		1.600/40,640	.105/ 2,67	30u"/0.76u MIN (NOTE 17) OVER 50u"/1.27u Ni	
-196				.105/ 2,67	120u"~200u"/3.04um~5.08umTIN/LEAD	NOTE 16,19
-197				.150/ 3,81	30u"/0.76u MIN (NOTE 17) OVER 50u"/1.27u Ni	
-198				.150/ 3,81	120u"~200u"/3.04um~5.08umTIN/LEAD	NOTE 16,19
-199				.675/17,15	30u"/0.76u MIN (NOTE 17) OVER 50u"/1.27u Ni	
-200	2x17		1.600/40,640	.675/17,15	120u"~200u"/3.04um~5.08umTIN/LEAD	NOTE 16,19
-201	2x20		1.900/48,260	.105/ 2,67	30u"/0.76u MIN (NOTE 17) OVER 50u"/1.27u Ni	
-202				.105/ 2,67	120u"~200u"/3.04um~5.08umTIN/LEAD	NOTE 16,19
-203				.150/ 3,81	30u"/0.76u MIN (NOTE 17) OVER 50u"/1.27u Ni	
-204				.150/ 3,81	120u"~200u"/3.04um~5.08umTIN/LEAD	NOTE 16,19
-205				.675/17,15	30u"/0.76u MIN (NOTE 17) OVER 50u"/1.27u Ni	
-206	2x20		1.900/48,260	.675/17,15	120u"~200u"/3.04um~5.08umTIN/LEAD	NOTE 16,19
-207	2x25		2.400/60,960	.105/ 2,67	30u"/0.76u MIN (NOTE 17) OVER 50u"/1.27u Ni	
-208				.105/ 2,67	120u"~200u"/3.04um~5.08umTIN/LEAD	NOTE 16,19
-209				.150/ 3,81	30u"/0.76u MIN (NOTE 17) OVER 50u"/1.27u Ni	
-210				.150/ 3,81	120u"~200u"/3.04um~5.08umTIN/LEAD	NOTE 16,19
-211				.675/17,15	30u"/0.76u MIN (NOTE 17) OVER 50u"/1.27u Ni	
-212	2x25		2.400/60,960	.675/17,15	120u"~200u"/3.04um~5.08umTIN/LEAD	NOTE 16,19
-213	2x30		2.900/73,660	.105/ 2,67	30u"/0.76u MIN (NOTE 17) OVER 50u"/1.27u Ni	
-214	2x30		2.900/73,660	.105/ 2,67	120u"~200u"/3.04um~5.08umTIN/LEAD	NOTE 16,19
-215	2x30		2.900/73,660	.150/ 3,81	30u"/0.76u MIN (NOTE 17) OVER 50u"/1.27u Ni	
65863-216	2x30	LP	2.900/73,660	.150/ 3,81	120u"~200u"/3.04um~5.08umTIN/LEAD	D

mat'l. code		surface	tolerance	projection	product family
ISO 1302		ISO 406	ISO 1101		QUICKIE
ltr		ecn no		title	
BG				HEADER, QUICKIE SEA-HORSE, VERTICAL	
date		angles		MM	
		linear		scale 1:1	
		0±2°		Amphenol FCI	
dr		M. CORNMAN		dwg no	
		8/21/90		sheet 8 of 23 size	
enr		M. SMYK		65863	
		8/21/90		A3	
chr		M. SMYK		type Product Customer Drawing	
		8/21/90			
appd		M. SMYK			
		8/21/90			
sheet	revision				
index	sheet				

Amphenol FCI

© 2016 AFCI

PRODUCT NO NOTES 12,13	SIZE	LATCH NOTE 8	DIM B	DIM D	TERMINAL PLATING	STYLE
65863-217	2x30	LP	2.900/73,660	.675/17,15	30u"/0.76u MIN (NOTE 17) OVER 50u"/1.27u Ni	D
-218	2x30		2.900/73,660	.675/17,15	120u"~200u"/3.04um~5.08umTIN/LEAD	D
-219	2x5		.400/10,160	.105/ 2,67	30u"/0.76u MIN (NOTE 17) OVER 50u"/1.27u Ni	A
-220	2x7		.600/15,240			C
-221	2x8		.700/17,780			D
-222	2x10		.900/22,860			
-223	2x13		1.200/30,480			
-224	2x17		1.600/40,640			
-225	2x20		1.900/48,260			
-226	2x25		2.400/60,960			
-227	2x30		2.900/73,660	.105/ 2,67		
-228	2x20		1.900/48,260	.150/ 3,81		D
-229	2x5		.400/10,160			A
-230	2x7		.600/15,240			C
-231	2x8		.700/17,780			D
-232	2x10		.900/22,860			
-233	2x13		1.200/30,480			
-234	2x17		1.600/40,640			
-235	2x20		1.900/48,260			
-236	2x25		2.400/60,960			
-237	2x30		2.900/73,660	.150/ 3,81	30u"/0.76u MIN (NOTE 17) OVER 50u"/1.27u Ni	D
-238	2x5		.400/10,160	.675/17,15	15u"/0.38u MIN (NOTE 17) OVER 50u"/1.27u Ni	A
-239	2x7		.600/15,240			C
-240	2x8		.700/17,780			D
-241	2x10		.900/22,860			
-242	2x13		1.200/30,480			
-243	2x17		1.600/40,640			
-244	2x20		1.900/48,260			
-245	2x25		2.400/60,960			
-246	2x30	LP	2.900/73,660	.675/17,15	15u"/0.38u MIN (NOTE 17) OVER 50u"/1.27u Ni	D
-247	2x5	NO	.400/10,160	.105/ 2,67	30u"/0.76u MIN (NOTE 17) OVER 50u"/1.27u Ni	A
-248	2x7		.600/15,240			C
-249	2x8		.700/17,780			D
-250	2x10		.900/22,860			D
-251	2x13		1.200/30,480			D
65863-252	2x17	NO	1.600/40,640	.105/ 2,67	30u"/0.76u MIN (NOTE 17) OVER 50u"/1.27u Ni	D

NOTE 16,19

Amphenol
FCI

© 2016 AFCI

mat'l. code		surface	tolerance	projection	product family	
ISO 1302		ISO 406	ISO 1101		QUICKIE	
tolerances unless otherwise specified				MM	title	
angles		.XX±.01/.X±0.3		scale 1:1	HEADER, QUICKIE	
linear		.XXX±.005/.XX±0.13			SEA-HORSE, VERTICAL	
0±2°		.XXX±.0020 .XXX±0.051			dwg no	
dr		M. CORNMAN	8/21/90	Amphenol FCI	sheet 9 of 23 size	
enr		M. SMYK	8/21/90		65863	A3
chr		M. SMYK	8/21/90		type Product Customer Drawing	
appd		M. SMYK	8/21/90			
sheet index	revision sheet					

PRODUCT NO NOTE 12,13	SIZE	LATCH NOTE 8	DIM B	DIM D	TERMINAL PLATING	STYLE
65863-253	2x20	NO	1.900/48,260	.105/ 2,67	30u"/0.76u MIN (NOTE 17) OVER 50u"/1.27u Ni	D
-254	2x25		2.400/60,960	.105/ 2,67		D
-255	2x30		2.900/73,660	.105/ 2,67		D
-256	2x5		.400/10,160	.675/17,15		A
-257	2x7		.600/15,240			C
-258	2x8		.700/17,780			D
-259	2x10		.900/22,860			
-260	2x13		1.200/30,480			
-261	2x17		1.600/40,640			
-262	2x20		1.900/48,260			
-263	2x25		2.400/60,960			
-264	2x30	NO	2.900/73,660	.675/17,15		D
-265	2x5	STD	.400/10,160	.105/ 2,67		A
-266	2x7		.600/15,240			C
-267	2x8		.700/17,780			D
-268	2x10		.900/22,860			
-269	2x13		1.200/30,480			
-270	2x17		1.600/40,640			
-271	2x20		1.900/48,260			
-272	2x25		2.400/60,960			
-273	2x30		2.900/73,660	.105/ 2,67		D
-274	2x5		.400/10,160	.675/17,15		A
-275	2x7		.600/15,240			C
-276	2x8		.700/17,780			D
-277	2x10		.900/22,860			
-278	2x13		1.200/30,480			
-279	2x17		1.600/40,640			
-280	2x20		1.900/48,260			
-281	2x25		2.400/60,960			
-282	2x30	STD	2.900/73,660	.675/17,15		D
-283	2x5	LP	.400/10,160	.105/ 2,67		A
-284	2x7		.600/15,240			C
-285	2x8		.700/17,780			D
-286	2x10		.900/22,860			D
-287	2x13		1.200/30,480			D
65863-288	2x17	LP	1.600/40,640	.105/ 2,67	30u"/0.76u MIN (NOTE 17) OVER 50u"/1.27u Ni	D

Amphenol
FCI

© 2016 AFCI

mat'l. code		surface <input checked="" type="checkbox"/> ISO 1302		tolerance <input checked="" type="checkbox"/> ASH 406		projection		product family QUICKIE	
ltr		ecn no		date		tolerances unless otherwise specified		title	
BG						.XX±.01/.X±0.3 .XXX±.005/.XXX±0.13 .XXXX±.0020 .XXX±0.051		HEADER, QUICKIE SEA-HORSE, VERTICAL	
						linear 0±2°		MM scale 1:1	
				dr M. CORNMAN 8/21/90				dwg no 65863 sheet 10 of 23 size A3	
				enr M. SMYK 8/21/90				type Product Customer Drawing	
				chr M. SMYK 8/21/90					
				appd M. SMYK 8/21/90					
sheet index		revision sheet							

PRODUCT NO NOTE 12,13	SIZE	LATCH NOTE 8	DIM B	DIM D	TERMINAL PLATING	STYLE
65863-289	2x20	LP	1.900/48,260	.105/ 2,67	30u"/0.76u MIN (NOTE 17) OVER 50u"/1.27u Ni	D
-290	2x25		2.400/60,960	.105/ 2,67		D
-291	2x30		2.900/73,660	.105/ 2,67		D
-292	2x5		.400/10,160	.675/17,15		A
-293	2x7		.600/15,240			C
-294	2x8		.700/17,780			D
-295	2x10		.900/22,860			
-296	2x13		1.200/30,480			
-297	2x17		1.600/40,640			
-298	2x20		1.900/48,260			
-299	2x25		2.400/60,960			
-300	2x30	LP	2.900/73,660	.675/17,15	30u"/0.76u MIN (NOTE 17) OVER 50u"/1.27u Ni	D
-301	2x5	NO	.400/10,160	.105/ 2,67	15u"/0.38u MIN (NOTE 17) OVER 50u"/1.27u Ni	A
-302	2x7		.600/15,240			C
-303	2x8		.700/17,780			D
-304	2x10		.900/22,860			
-305	2x13		1.200/30,480			
-306	2x17		1.600/40,640			
-307	2x20		1.900/48,260			
-308	2x25		2.400/60,960			
-309	2x30		2.900/73,660	.105/ 2,67		D
-310	2x5		.400/10,160	.150/ 3,81		A
-311	2x7		.600/15,240			C
-312	2x8		.700/17,780			D
-313	2x10		.900/22,860			
-314	2x13		1.200/30,480			
-315	2x17		1.600/40,640			
-316	2x20		1.900/48,260			
-317	2x25		2.400/60,960			
-318	2x30	NO	2.900/73,660	.150/ 3,81		D
-319	2x5	STD	.400/10,160	.105/ 2,67		A
-320	2x7		.600/15,240			C
-321	2x8		.700/17,780			D
-322	2x10		.900/22,860			D
-323	2x13		1.200/30,480			D
65863-324	2x17	STD	1.600/40,640	.105/ 2,67	15u"/0.38u MIN (NOTE 17) OVER 50u"/1.27u Ni	D

Amphenol
FCI

© 2016 AFCI

©

©

D

mat'l. code		surface <input checked="" type="checkbox"/> ISO 1302 <input checked="" type="checkbox"/> tolerance <input checked="" type="checkbox"/> ISO 406 <input checked="" type="checkbox"/> ISO 1101		projection 		product family QUICKIE	
ltr		ecn no		dr		date	
BG							
angles		linear		MM		title	
				scale 1:1		HEADER, QUICKIE SEA-HORSE, VERTICAL	
dr		enr		chr		appd	
M. CORNMAN		M. SMYK		M. SMYK		M. SMYK	
8/21/90		8/21/90		8/21/90		8/21/90	
sheet index		revision sheet				dwg no 65863 sheet 11 of 23 size A3	
						type Product Customer Drawing	

PRODUCT NO NOTE 12,13	SIZE	LA ICF NOTE 8	DIM B	DIM D	TERMINAL PLATING	STYLE
65863-325	2x20	STD	1.900/48,260	.105/ 2,67	15u"/0.38u MIN (NOTE 17) OVER 50u"/1.27u Ni	D
-326	2x25		2.400/60,960	.105/ 2,67		D
-327	2x30		2.900/73,660	.105/ 2,67		D
-328	2x5		.400/10,160	.150/ 3,81		A
-329	2x7		.600/15,240			C
-330	2x8		.700/17,780			D
-331	2x10		.900/22,860			
-332	2x13		1.200/30,480			
-333	2x17		1.600/40,640			
-334	2x20		1.900/48,260			
-335	2x25		2.400/60,960			
-336	2x30	STD	2.900/73,660	.150/ 3,81		D
-337	2x5	LP	.400/10,160	.105/ 2,67		A
-338	2x7		.600/15,240			C
-339	2x8		.700/17,780			D
-340	2x10		.900/22,860			
-341	2x13		1.200/30,480			
-342	2x17		1.600/40,640			
-343	2x20		1.900/48,260			
-344	2x25		2.400/60,960			
-345	2x30		2.900/73,660	.105/ 2,67		D
-346	2x5		.400/10,160	.150/ 3,81		A
-347	2x7		.600/15,240			C
-348	2x8		.700/17,780			D
-349	2x10		.900/22,860			
-350	2x13		1.200/30,480			
-351	2x17		1.600/40,640			
-352	2x20		1.900/48,260			
-353	2x25		2.400/60,960			
-354	2x30	LP	2.900/73,660	.150/ 3,81	15u"/0.38u MIN (NOTE 17) OVER 50u"/1.27u Ni	D
-355	2x5	NO	.400/10,160	.105/ 2,67	30u"/0.76u MIN (NOTE 17) OVER 50u"/1.27u Ni	B
-356		NO			15u"/0.38u MIN (NOTE 17) OVER 50u"/1.27u Ni	
-357		NO			30u"/0.76u MIN (NOTE 17) OVER 50u"/1.27u Ni	
-358		NO			120u"~200u"/3.04um~5.08umTIN/LEAD	NOTE 16,19
-359		STD			30u"/0.76u MIN (NOTE 17) OVER 50u"/1.27u Ni	
65863-360	2x5	STD	.400/10,160	.105/ 2,67	15u"/0.38u MIN (NOTE 17) OVER 50u"/1.27u Ni	B

Amphenol FCI

© 2016 AFCI

NOTE 16,19

mat'l. code		surface <input checked="" type="checkbox"/> ISO 1302		tolerance <input checked="" type="checkbox"/> ISO 406		projection 		product family QUICKIE	
ltr		ecn no		dr		date		title	
BG								HEADER, QUICKIE SEA-HORSE, VERTICAL	
								dwg no	
								65863	
								sheet 12 of 23 size	
								A3	
								type Product Customer Drawing	
sheet index		revision sheet							

PRODUCT NO NOTE 12,13	SIZE	LATCH NOTE 8	DIM B	DIM D	TERMINAL PLATING	STYLE
65863-361	2x5	STD	.400/10,160	.105/ 2,67	30u"/0.76u MIN (NOTE 17) OVER 50u"/1.27u Ni	B
-362		STD			120u-200u"/3.04u-5.08u TIN/LEAD	NOTE 16,19
-363		LP			30u"/0.76u MIN (NOTE 17) OVER 50u"/1.27u Ni	
-364		LP			15u"/0.38u MIN (NOTE 17) OVER 50u"/1.27u Ni	
-365		LP			30u"/0.76u MIN (NOTE 17) OVER 50u"/1.27u Ni	
-366		LP		.105/ 2,67	120u-200u"/3.04u-5.08u TIN/LEAD	NOTE 16,19
-367		NO		.150/ 3,81	30u"/0.76u MIN (NOTE 17) OVER 50u"/1.27u Ni	
-368		NO			15u"/0.38u MIN (NOTE 17) OVER 50u"/1.27u Ni	
-369		NO			30u"/0.76u MIN (NOTE 17) OVER 50u"/1.27u Ni	
-370		NO			120u-200u"/3.04u-5.08u TIN/LEAD	NOTE 16,19
-371		STD			30u"/0.76u MIN (NOTE 17) OVER 50u"/1.27u Ni	
-372		STD			15u"/0.38u MIN (NOTE 17) OVER 50u"/1.27u Ni	
-373		STD			30u"/0.76u MIN (NOTE 17) OVER 50u"/1.27u Ni	
-374		STD			120u-200u"/3.04u-5.08u TIN/LEAD	NOTE 16,19
-375		LP			30u"/0.76u MIN (NOTE 17) OVER 50u"/1.27u Ni	
-376		LP			15u"/0.38u MIN (NOTE 17) OVER 50u"/1.27u Ni	
-377		LP			30u"/0.76u MIN (NOTE 17) OVER 50u"/1.27u Ni	
-378		LP		.150/ 3,81	120u-200u"/3.04u-5.08u TIN/LEAD	NOTE 16,19
-379		NO		.675/17,15	30u"/0.76u MIN (NOTE 17) OVER 50u"/1.27u Ni	
-380		NO			15u"/0.38u MIN (NOTE 17) OVER 50u"/1.27u Ni	
-381		NO			30u"/0.76u MIN (NOTE 17) OVER 50u"/1.27u Ni	
-382		NO			120u-200u"/3.04u-5.08u TIN/LEAD	NOTE 16,19
-383		STD			30u"/0.76u MIN (NOTE 17) OVER 50u"/1.27u Ni	
-384		STD			15u"/0.38u MIN (NOTE 17) OVER 50u"/1.27u Ni	
-385		STD			30u"/0.76u MIN (NOTE 17) OVER 50u"/1.27u Ni	
-386		STD			120u-200u"/3.04u-5.08u TIN/LEAD	NOTE 16,19
-387		LP			30u"/0.76u MIN (NOTE 17) OVER 50u"/1.27u Ni	
-388		LP			15u"/0.38u MIN (NOTE 17) OVER 50u"/1.27u Ni	
-389		LP			30u"/0.76u MIN (NOTE 17) OVER 50u"/1.27u Ni	
-390	2x5	LP	.400/10,160	.675/17,15	120u-200u"/3.04u-5.08u TIN/LEAD	B NOTE 16,19
-391	2x9	STD	.800/20,320	.105/ 2,67	30u"/0.76u MIN (NOTE 17) OVER 50u"/1.27u Ni	D
-392	2x9	NO	.800/20,320	.105/ 2,67	30u"/0.76u MIN (NOTE 17) OVER 50u"/1.27u Ni	D
-393	2x9	LP	.800/20,320	.105/ 2,67	30u"/0.76u MIN (NOTE 17) OVER 50u"/1.27u Ni	D
-394	2x5	NO	.400/10,160	.105/ 2,67	15u"/0.38u MIN (NOTE 17) OVER 50u"/1.27u Ni	A
65863-395	2x5	STD	.400/10,160	.105/ 2,67	15u"/0.38u MIN (NOTE 17) OVER 50u"/1.27u Ni	A

Amphenol FCI

© 2016 AFCI

mat'l. code		surface	tolerance	projection	product family
ISO 1302		ISO 406	ISO 1101		QUICKIE
ltr		ecn no		title	
dr		date		HEADER, QUICKIE	
BG				SEA-HORSE, VERTICAL	
		angles	linear	MM	
		0±2°	.XX±.01/XX±0.3	scale 1:1	
		dr	M. CORNMAN	8/21/90	dwg no
		enr	M. SMYK	8/21/90	sheet 13 of 23 size
		chr	M. SMYK	8/21/90	65863 A3
		appd	M. SMYK	8/21/90	type Product Customer Drawing
sheet	revision				
index	sheet				

PRODUCT NO NOTES 12,13	SIZE	LATCH NOTE 8	DIM B	DIM D	TERMINAL PLATING	PIN STYLE	MISSING
65863-431	2x17	STD	1.600/40.640	.105/ 2,67	15u"/0.38u MIN (NOTE 17) OVER 50u"/1.27u Ni	D	NONE
-432		LP		.105/ 2,67			
-433		NO		.150/ 3,81			
-434		STD		.150/ 3,81			
-435	2x17	LP	1.600/40.640	.150/ 3,81			
-436	2x20	NO	1.900/48.260	.105/ 2,67			
-437		STD		.105/ 2,67			
-438		LP		.105/ 2,67			
-439		NO		.150/ 3,81			
-440		STD		.150/ 3,81			
-441	2x20	LP	1.900/48.260	.150/ 3,81			
-442	2x25	NO	2.400/60.960	.105/ 2,67			
-443		STD		.105/ 2,67			
-444		LP		.105/ 2,67			
-445		NO		.150/ 3,81			
-446		STD		.150/ 3,81			
-447	2x25	LP	2.400/60.960	.150/ 3,81			
-448	2x30	NO	2.900/73.660	.105/ 2,67			
-449		STD		.105/ 2,67			
-450		LP		.105/ 2,67			
-451		NO		.150/ 3,81			
-452		STD		.150/ 3,81			
-453	2x30	LP	2.900/73.660	.150/ 3,81			
-454	2x12	NO	1.100/27.940	.105/ 2,67			
-455	2x12	STD					
-456	2x12	LP					
-456S	2x12	LP			15u"/0.38u MIN (NOTE 17) OVER 50u"/1.27u Ni		
-457	2x12	NO			30u"/0.76u MIN (NOTE 17) OVER 50u"/1.27u Ni		
-458		STD			30u"/0.76u MIN (NOTE 17) OVER 50u"/1.27u Ni		
-459		LP			30u"/0.76u MIN (NOTE 17) OVER 50u"/1.27u Ni		
-460		NO			30u"/0.76u MIN (NOTE 17) OVER 50u"/1.27u Ni		
-461		STD			30u"/0.76u MIN (NOTE 17) OVER 50u"/1.27u Ni		
-462		LP			30u"/0.76u MIN (NOTE 17) OVER 50u"/1.27u Ni		
-463		NO			120u"-200u"/3.04u-5.08uTIN/LEAD		
-464		STD			120u"-200u"/3.04u-5.08uTIN/LEAD		
65863-465	2x12	LP	1.100/27.940	.105/ 2,67	120u"-200u"/3.04u-5.08uTIN/LEAD	D	NONE

NOTE 18

NOTE 16,19

NOTE 16,19

NOTE 16,19

Amphenol
FCI

© 2016 AFCI

©

©

mat'l. code		surface	tolerance	projection	product family
ISO 1302		ISO 406	ISO 1101		QUICKIE
ltr		tolerances unless otherwise specified		MM	title
ecn no	dr	angles	linear		
BG			.XX±.01/XX±0.3	scale 1:1	SEA-HORSE, VERTICAL
			.XXX±.005/XXX±0.13		
			.XXX±.0020 .XXX±0.051		
		dr	M. CORNMAN	8/21/90	dwg no
		enr	M. SMYK	8/21/90	sheet 15 of 23 size
		chr	M. SMYK	8/21/90	65863
		appd	M. SMYK	8/21/90	A3
sheet	revision				type Product Customer Drawing
index	sheet				

PRODUCT NO NOTE 12,13	SIZE	LA ICI NOTE 8	DIM B	DIM D	TERMINAL PLATING	STYLE
65863-466	2x12	NO	1.100/27.940	.150/3.81	15u"/0.38u MIN (NOTE 17) OVER 50u"/1.27u Ni	D
-467		STD			15u"/0.38u MIN (NOTE 17) OVER 50u"/1.27u Ni	
-468		LP			15u"/0.38u MIN (NOTE 17) OVER 50u"/1.27u Ni	
-469		NO			30u"/0.76u MIN (NOTE 17) OVER 50u"/1.27u Ni	
-470		STD			30u"/0.76u MIN (NOTE 17) OVER 50u"/1.27u Ni	
-471		LP			30u"/0.76u MIN (NOTE 17) OVER 50u"/1.27u Ni	
-472		NO			30u"/0.76u MIN (NOTE 17) OVER 50u"/1.27u Ni	
-473		STD			30u"/0.76u MIN (NOTE 17) OVER 50u"/1.27u Ni	
-474		LP			30u"/0.76u MIN (NOTE 17) OVER 50u"/1.27u Ni	
-475		NO			120u-200u"/3.04u-5.08u TIN/LEAD	NOTE 16,19
-476		STD			120u-200u"/3.04u-5.08u TIN/LEAD	NOTE 16,19
-477		LP		.150/3.81	120u-200u"/3.04u-5.08u TIN/LEAD	NOTE 16,19
-478		NO		.105/2.67	15u"/0.38u MIN (NOTE 17) OVER 50u"/1.27u Ni	
-479		STD			15u"/0.38u MIN (NOTE 17) OVER 50u"/1.27u Ni	
-480		LP			15u"/0.38u MIN (NOTE 17) OVER 50u"/1.27u Ni	
-481		NO			30u"/0.76u MIN (NOTE 17) OVER 50u"/1.27u Ni	
-482		STD			30u"/0.76u MIN (NOTE 17) OVER 50u"/1.27u Ni	
-483		LP		.105/2.67	30u"/0.76u MIN (NOTE 17) OVER 50u"/1.27u Ni	
-484		NO		.150/3.81	15u"/0.38u MIN (NOTE 17) OVER 50u"/1.27u Ni	
-485		STD		.150/3.81	15u"/0.38u MIN (NOTE 17) OVER 50u"/1.27u Ni	
-486		LP		.150/3.81	15u"/0.38u MIN (NOTE 17) OVER 50u"/1.27u Ni	
-487		NO		.675/17.15	15u"/0.38u MIN (NOTE 17) OVER 50u"/1.27u Ni	
-488		STD			15u"/0.38u MIN (NOTE 17) OVER 50u"/1.27u Ni	
-489		LP			15u"/0.38u MIN (NOTE 17) OVER 50u"/1.27u Ni	
-490		NO			30u"/0.76u MIN (NOTE 17) OVER 50u"/1.27u Ni	
-491		STD			30u"/0.76u MIN (NOTE 17) OVER 50u"/1.27u Ni	
-492		LP			30u"/0.76u MIN (NOTE 17) OVER 50u"/1.27u Ni	
-493		NO			30u"/0.76u MIN (NOTE 17) OVER 50u"/1.27u Ni	
-494		STD			30u"/0.76u MIN (NOTE 17) OVER 50u"/1.27u Ni	
-495		LP			30u"/0.76u MIN (NOTE 17) OVER 50u"/1.27u Ni	
-496		NO			120u-200u"/3.04u-5.08u TIN/LEAD	NOTE 16,19
-497		STD			120u-200u"/3.04u-5.08u TIN/LEAD	NOTE 16,19
-498	2x12	LP	1.100/27.940	.675/17.15	120u-200u"/3.04u-5.08u TIN/LEAD	NOTE 16,19
-499	2x15	NO	1.400/35.560	.105/2.67	15u"/0.38u MIN (NOTE 17) OVER 50u"/1.27u Ni	
65863-500	2x15	STD	1.400/35.560	.105/2.67	15u"/0.38u MIN (NOTE 17) OVER 50u"/1.27u Ni	D

Amphenol FCI

© 2016 AFCI

mat'l. code		surface <input checked="" type="checkbox"/> ISO 1302 <input type="checkbox"/> tolerance <input checked="" type="checkbox"/> ISO 406 <input type="checkbox"/> ISO 1101		projection 		product family QUICKIE	
ltr		ecn no		date		title	
BG						HEADER, QUICKIE SEA-HORSE, VERTICAL	
		angles		linear		MM	
		0±2°		.XX±.01/.X±0.3 .XXX±.005/.XX±0.13 .XXX±.0020 .XXX±0.051		scale 1:1	
		dr		M. CORNMAN		8/21/90	
		enr		M. SMYK		8/21/90	
		chr		M. SMYK		8/21/90	
		appd		M. SMYK		8/21/90	
sheet		revision				dwg no	
index		sheet				65863	
						sheet 16 of 23 size	
						A3	
						type Product Customer Drawing	

PRODUCT NO NOTE 12,13	SIZE	LATCH NOTE 8	DIM B	DIM D	TERMINAL PLATING	STYLE
65863-571	2x22	NO	2.100/53.340	.105/2.67	30u"/0.76u MIN (NOTE 17) OVER 50u"/1.27u Ni	D
-572		STD		.105/2.67	30u"/0.76u MIN (NOTE 17) OVER 50u"/1.27u Ni	
-573		LP		.105/2.67	30u"/0.76u MIN (NOTE 17) OVER 50u"/1.27u Ni	
-574		NO		.150/3.81	15u"/0.38u MIN (NOTE 17) OVER 50u"/1.27u Ni	
-575		STD		.150/3.81	15u"/0.38u MIN (NOTE 17) OVER 50u"/1.27u Ni	
-576		LP		.150/3.81	15u"/0.38u MIN (NOTE 17) OVER 50u"/1.27u Ni	
-577		NO		.675/17.15	15u"/0.38u MIN (NOTE 17) OVER 50u"/1.27u Ni	
-578		STD			15u"/0.38u MIN (NOTE 17) OVER 50u"/1.27u Ni	
-579		LP			15u"/0.38u MIN (NOTE 17) OVER 50u"/1.27u Ni	
-580		NO			30u"/0.76u MIN (NOTE 17) OVER 50u"/1.27u Ni	
-581		STD			30u"/0.76u MIN (NOTE 17) OVER 50u"/1.27u Ni	
-582		LP			30u"/0.76u MIN (NOTE 17) OVER 50u"/1.27u Ni	
-583		NO			30u"/0.76u MIN (NOTE 17) OVER 50u"/1.27u Ni	
-584		STD			30u"/0.76u MIN (NOTE 17) OVER 50u"/1.27u Ni	
-585		LP			30u"/0.76u MIN (NOTE 17) OVER 50u"/1.27u Ni	
-586		NO			120u-200u"/3.04u-5.08u TIN/LEAD	
-587		STD			120u-200u"/3.04u-5.08u TIN/LEAD	
-588	2x22	LP	2.100/53.340	.675/17.15	120u-200u"/3.04u-5.08u TIN/LEAD	
-589	2x25	STD	2.400/60.960	.150/3.81	30u"/0.76u MIN (NOTE 17) OVER 50u"/1.27u Ni	
-590		66258		.105/2.67		
-591		66258		.150/3.81		
-592	2x25	NO	2.400/60.960		30u"/0.76u MIN (NOTE 17) OVER 50u"/1.27u Ni	
-593	2x13	LP	1.200/30.480		50u"/1.27u MIN (NOTE 17) OVER 50u"/1.27u Ni	
-594	2x13	NO	1.200/30.480	.150/3.81		
-595	2x10	NO	.900/22.860	.150/3.81		
-596	2x10	STD	.900/22.860	.150/3.81		D
-597	2x5	LP	.400/10.160	.150/3.81		A
-598	2x5	NO	.400/10.160	.150/3.81		A
-599	2x5	LP	.400/10.160	.675/17.15		A
-600	2x5	NO	.400/10.160	.675/17.15	50u"/1.27u MIN (NOTE 17) OVER 50u"/1.27u Ni	A
-601	2X32	NO	3.100/78.740	.105/2.67	15u"/0.38u MIN (NOTE 17) OVER 50u"/1.27u Ni	D
-602	2X32	STD	3.100/78.740	.105/2.67	15u"/0.38u MIN (NOTE 17) OVER 50u"/1.27u Ni	D
-603	2X32	LP	3.100/78.740	.105/2.67	15u"/0.38u MIN (NOTE 17) OVER 50u"/1.27u Ni	D
65863-604	2X32	NO	3.100/78.740	.105/2.67	30u"/0.76u MIN (NOTE 17) OVER 50u"/1.27u Ni	D

NOTE 16,19
NOTE 16,19
NOTE 16,19

Amphenol
FCI

© 2016 AFCI

mat'l. code		surface	tolerance	projection	product family
ISO 1302		ISO 406	ISO 1101		QUICKIE
ltr ecn no dr date		tolerances unless otherwise specified		MM	title HEADER, QUICKIE SEA-HORSE, VERTICAL
BG		angles	.XX±.01/.X±0.3		
		linear	.XXX±.005/.XXX±0.13	scale 1:1	dwg no 65863
		0±2°	.XXX±.0020 .XXX±0.051		
		dr	M. CORNMAN	8/21/90	sheet 19 of 23 size
		enr	M. SMYK	8/21/90	A3
		chr	M. SMYK	8/21/90	type Product Customer Drawing
		appd	M. SMYK	8/21/90	
sheet index	revision sheet				

PRODUCT NO NOTE 12,13	SIZE	LATCH NOTE 8	DIM B	DIM D	TERMINAL PLATING	STYLE	PIN MISSING
65863-640	2x12	NO	1.100/ 27.94	.150/3,81	30u"/0.76u MIN (NOTE 17) OVER 50u"/1.27u Ni	D	NONE
-641	2x12	STD	1.100/ 27.94				
-642	2x15	NO	1.400/ 35.56				
-643	2x15	STD	1.400/ 35.56				
-644	2x30	NO	2.900/ 73.66				
-645	2x30	STD	2.900/ 73.66				
-646	2x25	STD	2.400/ 60.96			D	
-647	2x5	STD	.400/ 10.16			A	
-648	2x7	STD	.600/ 15.24			C	
-649	2x13	STD	1.120/ 30.48			D	
-650	2x17	STD	1.600/ 40.64			D	
-651	2x5	NO	.400/ 10.16			A	
-652	2x7	NO	.600/ 15.24			C	
-653	2x13	NO	1.120/ 30.48			D	
-654	2x17	NO	1.600/ 40.64	.150/3,81		D	
-655	2x5	STD	.400/ 10.16	.175/4.45		A	
-656	2x7		.600/ 15.24			C	
-657	2x13		1.120/ 30.48			D	
-658	2x17	STD	1.600/ 40.64	.175/4.45		D	
-659	2x5	NO	.400/ 10.16	.250/6.35		A	
-660	2x7	LP	.600/ 15.24	.236/5.99	30u"/0.76u MIN (NOTE 17) OVER 50u"/1.27u Ni	C	NONE
-715	2x8	LP	.700/ 17.78	.150/3.81	30u"/0.76u MIN (NOTE 17) OVER 50u"/1.27u Ni	D	3
-716	2x8	LP	.700/ 17.78	.150/3.81	30u"/0.76u MIN (NOTE 17) OVER 50u"/1.27u Ni	D	14
-717	2X20	LP	1.900/48.26	.150/3.81	30u"/0.76u MIN (NOTE 17) OVER 50u"/1.27u Ni	D	20
-717S	2X20	LP	1.900/48.26	.150/3.81	30u"/0.76u MIN (NOTE 17) OVER 50u"/1.27u Ni	D	20
-733	2x17	LP	1.600/ 40.14	.105/2.67	50u"/1.27u MIN (NOTE 17) OVER 50u"/1.27u Ni	D	5
-734	2x17	STD	1.600/ 40.64	.105/2.67	50u"/1.27u MIN (NOTE 17) OVER 50u"/1.27u Ni	D	5
-735	2x10	LP	.900/ 22.86	.150/3.81	30u"/0.76u MIN (NOTE 17) OVER 50u"/1.27u Ni	D	16
-736	2x10	LP	.900/ 22.86		30u"/0.76u MIN (NOTE 17) OVER 50u"/1.27u Ni	D	19
-737	2x5	LP	.400/ 10.16		30u"/0.76u MIN (NOTE 17) OVER 50u"/1.27u Ni	A	10
-738	2X20	LP	1.900/48.26		30u"/0.76u MIN (NOTE 17) OVER 50u"/1.27u Ni	D	8
-739	2X25	LP	2.400/60.96			D	25
-740	2X12	LP	1.100/ 27.94			D	20
-741	2X17	LP	1.600/ 40.64			D	5
-741S	2X17	LP	1.600/ 40.64			D	5
-742	2X5	LP	.400/ 10.16			A	2
65863-743	2X17	LP	1.600/ 40.64	.150/3.81	30u"/0.76u MIN (NOTE 17) OVER 50u"/1.27u Ni	D	3

NOTE 18

NOTE 18

Amphenol FCI

© 2016 AFCI

mat'l. code		surface	tolerance	projection	product family		
ISO 1302		ISO 406	ISO 1101		QUICKIE		
ltr		tolerances unless otherwise specified		MM	title		
ecn no	dr	angles	linear			HEADER, QUICKIE	
BG		0±2°	.XX±.01/XX±0.3	scale 1:1	SEA-HORSE, VERTICAL		
			.XXX±.005/XXX±0.13				
			.XXX±.0020 .XXX±0.051	Amphenol FCI	dwg no		
		dr	M. CORNMAN			8/21/90	sheet 21 of 23 size
		enr	M. SMYK			8/21/90	65863
		chr	M. SMYK			8/21/90	A3
		appd	M. SMYK	8/21/90	type Product Customer Drawing		
sheet index	revision sheet						

PRODUCT NO NOTE 12,13	SIZE	LAICH NOTE 8	DIM B	DIM D	TERMINAL PLATING	STYLE	MISSING PIN
65863-744	2x17	LP	1.600/ 40.64	.150/3.81	30u"/0.76u MIN (NOTE 17) OVER 50u"/1.27u Ni	D	3, 5
65863-744S	2x17	LP	1.600/ 40.64	.150/3.81	30u"/0.76u MIN (NOTE 17) OVER 50u"/1.27u Ni	D	3, 5
65863-843	2x5	N/A	.400/ 10.16	.120/3.05	15u"/0.38u MIN (NOTE 17) OVER 50u"/1.27u Ni	A	
-844	2x7		.600/ 15.24			C	
-845	2x10		.900/ 22.86			D	
-846	2x15		1.400/ 35.56				
-847	2x17		1.600/ 40.64				
-848	2X20		1.900/ 48.26				
-849	2X25		2.400/ 60.96				
-850	2x30	N/A	2.900/ 73.66			D	
-851	2x5	STD	.400/ 10.16			A	
-852	2x7		.600/ 15.24			C	N/A
-853	2x10		.900/ 22.86			D	
-854	2x15		1.400/ 35.56				
-855	2x17		1.600/ 40.64				
-856	2X20		1.900/ 48.26				
-857	2X25		2.400/ 60.96				
-858	2x30	STD	2.900/ 73.66			D	
-859	2x5	L/P	.400/ 10.16			A	
-860	2x7		.600/ 15.24			C	
-861	2x10		.900/ 22.86			D	
-861S	2x10		.900/ 22.86			D	
-862	2x15		1.400/ 35.56				
-863	2x17		1.600/ 40.64				
-864	2X20		1.900/ 48.26				
-865	2X25		2.400/ 60.96				
65863-866	2x30	L/P	2.900/ 73.66	.120/3.05		D	
65863-867S	2x12	L/P	1.100/ 27.94	.105/2.67	15u"/0.38u MIN (NOTE 17) OVER 50u"/1.27u Ni	D	24
65863-868S	2x12	L/P	1.100/ 27.94	.105/2.67	30u"/0.76u MIN (NOTE 17) OVER 50u"/1.27u Ni	D	24

NOTE 18

NOTE 18

NOTE 18

NOTE 18

Amphenol FCI
© 2016 AFCI

mat'l. code		surface <input checked="" type="checkbox"/> ISO 1302 <input checked="" type="checkbox"/> tolerance <input checked="" type="checkbox"/> ASH 406 <input checked="" type="checkbox"/> ISO 1101		projection 		product family QUICKIE	
ltr		ecn no		dr		date	
BG							
angles		linear		MM		title HEADER, QUICKIE SEA-HORSE, VERTICAL	
				scale 1:1		dwg no 65863	
				Amphenol FCI		sheet 22 of 23 size A3	
						type Product Customer Drawing	
sheet index		revision sheet					

PRODUCT NO NOTE 12,13	SIZE	LAICH NOTE 8	DIM B	DIM D	TERMINAL PLATING	STYLE
65863-049P	2x5	STD	.400/10,160	.105/ 2,67	30u"/0.76u MIN (NOTE 17) OVER 50u"/1.27u Ni	A
65863-055P	2x7	STD	.600/15,240	.105/ 2,67	30u"/0.76u MIN (NOTE 17) OVER 50u"/1.27u Ni	C
65863-061P	2x8	STD	.700/17,780	.105/ 2,67	30u"/0.76u MIN (NOTE 17) OVER 50u"/1.27u Ni	D
65863-067P	2x10	STD	.900/22,860	.105/ 2,67	30u"/0.76u MIN (NOTE 17) OVER 50u"/1.27u Ni	D
65863-073P	2x13	STD	1.200/30,480	.105/ 2,67	30u"/0.76u MIN (NOTE 17) OVER 50u"/1.27u Ni	D
65863-079P	2x17	STD	1.600/40,640	.105/ 2,67	30u"/0.76u MIN (NOTE 17) OVER 50u"/1.27u Ni	D
65863-085P	2x20	STD	1.900/48,260	.105/ 2,67	30u"/0.76u MIN (NOTE 17) OVER 50u"/1.27u Ni	D
65863-091P	2x25	STD	2.400/60,960	.105/ 2,67	30u"/0.76u MIN (NOTE 17) OVER 50u"/1.27u Ni	D
65863-203P	2x20	LP	1.900/48,260	.105/ 2,67	30u"/0.76u MIN (NOTE 17) OVER 50u"/1.27u Ni	D
65863-079F	2x17	STD	1.600/40,640	.105/ 2,67	30u"/0.76u MIN (NOTE 17) OVER 50u"/1.27u Ni	D
65863-081F	2x17	STD	1.600/40,640	.150/ 3.81	30u"/0.76u MIN (NOTE 17) OVER 50u"/1.27u Ni	D

Amphenol
FCI

© 2016 AFCI

mat'l. code		surface ISO 1302	tolerance ISO 406 ISO 1101	projection 	product family QUICKIE
ltr	ecn no	dr	date	title HEADER, QUICKIE SEA-HORSE, VERTICAL	
BG				angles linear	scale 1:1
				dr	M. CORNMAN 8/21/90
				enr	M. SMYK 8/21/90
				chr	M. SMYK 8/21/90
				appd	M. SMYK 8/21/90
sheet index	revision sheet				dwg no 65863
					sheet 23 of 23 size A3
					type Product Customer Drawing

Mouser Electronics

Authorized Distributor

Click to View Pricing, Inventory, Delivery & Lifecycle Information:

[FCI / Amphenol:](#)

[65863-183](#) [65863-195](#) [65863-503](#) [65863-185](#) [65863-189](#) [65863-197](#) [65863-213](#) [65863-266](#) [65863-270](#) [65863-371](#) [65863-458](#) [65863-470](#) [65863-620](#) [65863-207](#) [65863-272](#) [65863-073LF](#) [65863-075LF](#) [65863-142LF](#) [65863-079LF](#) [65863-268LF](#) [65863-081LF](#) [65863-085LF](#) [65863-093LF](#) [65863-091LF](#) [65863-103LF](#) [65863-087LF](#) [65863-095LF](#) [65863-265LF](#) [65863-267LF](#) [65863-271](#) [65863-091](#) [65863-081](#) [65863-093](#) [65863-049](#) [65863-061](#) [65863-079](#) [65863-069](#) [65863-055](#) [65863-067](#) [65863-025](#) [65863-165](#) [65863-009LF](#) [65863-041LF](#) [65863-047LF](#) [65863-183LF](#) [65863-185LF](#) [65863-189LF](#) [65863-195LF](#) [65863-197LF](#) [65863-207LF](#) [65863-213LF](#) [65863-266LF](#) [65863-270LF](#) [65863-272LF](#) [65863-359LF](#) [65863-458LF](#) [65863-470LF](#) [65863-506LF](#) [65863-620LF](#) [65863-003LF](#) [65863-005LF](#) [65863-007LF](#) [65863-011LF](#) [65863-013LF](#) [65863-027LF](#) [65863-029LF](#) [65863-033LF](#) [65863-037LF](#) [65863-039LF](#) [65863-043LF](#) [65863-059LF](#) [65863-065LF](#) [65863-068LF](#) [65863-077LF](#) [65863-083LF](#) [65863-089LF](#) [65863-099LF](#) [65863-105LF](#) [65863-121LF](#) [65863-122LF](#) [65863-124LF](#) [65863-125LF](#) [65863-126LF](#) [65863-128LF](#) [65863-135LF](#) [65863-140LF](#) [65863-141LF](#) [65863-144LF](#) [65863-169LF](#) [65863-171LF](#) [65863-173LF](#) [65863-175LF](#) [65863-193LF](#) [65863-201LF](#) [65863-203LF](#) [65863-205LF](#) [65863-229LF](#) [65863-231LF](#) [65863-236LF](#) [65863-247LF](#)