

# Film Capacitors

## Metallized Polypropylene Film Capacitors (MKP)

**Series/Type:** B32774 ... B32778

**Date:** June 2018

© EPCOS AG 2018. Reproduction, publication and dissemination of this publication, enclosures hereto and the information contained therein without EPCOS' prior express consent is prohibited.

EPCOS AG is a TDK Group Company.

### Typical applications

- Frequency converters
- Industrial and high-end power supplies
- Solar inverters

### Climatic

- Max. operating temperature: 105 °C (case)
- Climatic category (IEC 60068-1:2013):  
40/105/56

### Construction

- Dielectric: Polypropylene (MKP)
- Plastic case (UL 94 V-0)
- Epoxy resin sealing (UL 94 V-0)

### Features

- Capacitance values up to 480  $\mu\text{F}$
- High CV product, compact
- Good self-healing properties
- Over-voltage capability
- Low losses with high current capability
- High reliability
- Long useful life
- RoHS-compatible

### Terminals

- Parallel wire leads, lead-free tinned
- 2-pin, 4-pin and 12-pin versions
- Standard lead lengths: 6 – 1 mm

### Marking

Manufacturer's logo and lot number, date code, rated capacitance (coded), capacitance tolerance (code letter) and rated DC voltage

### Delivery mode

Bulk (untaped)

**Dimensional drawings**

Number of wires	Lead spacing $e \pm 0.4$	Lead diameter $d_1 \pm 0.05$	Type
2-pin	27.5	0.8	B32774D
2-pin	37.5	1.0	B32776E
2-pin	37.5	1.0	B32776T
4-pin	37.5	1.2	B32776G
4-pin	37.5	1.2	B32776T
4-pin	52.5	1.2	B32778T
4-pin	52.5	1.2	B32778G
12-pin	52.5	1.2	B32778J

Dimensions in mm

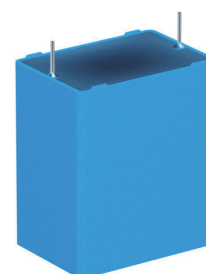
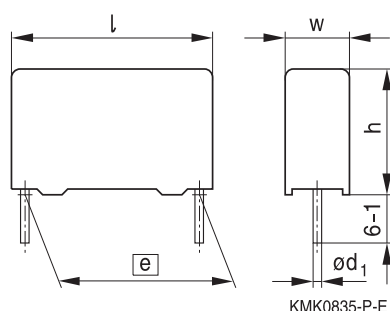
**Dimensional drawings 2-pin versions**
**B32774D, B32776E**

	B32774D	B32776E
Lead spacing $e \pm 0.4$ :	27.5	37.5
Lead diameter $d_1$ :	0.8	1.0

Dimensions in mm

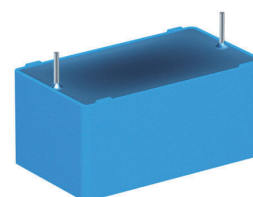
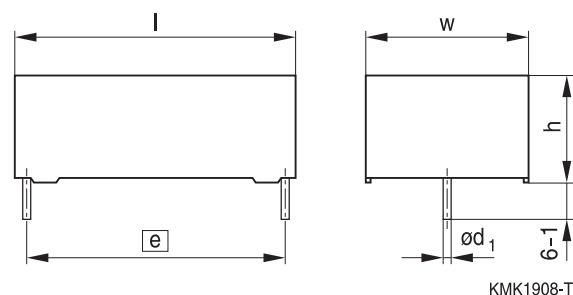
**B32776T (low profile)**

Lead spacing $e \pm 0.4$ :	37.5
Lead diameter $d_1$ :	1.0

Dimensions in mm



**B32774 ... B32778**

**MKP DC link – high density series up to 480  $\mu$ F**

**Dimensional drawings 4-pin versions**

**B32776G, B32778G**

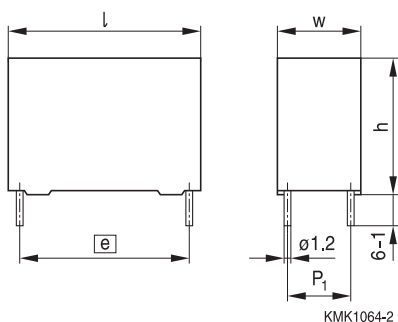

KMK1064-2

	B32776G	B32778G
Lead spacing $e \pm 0.4$ :	37.5	52.5
Lead diameter $d_1$ :	1.2	1.2

Dimensions in mm

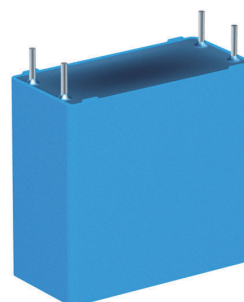

**B32776T, B32778T (low profile)**

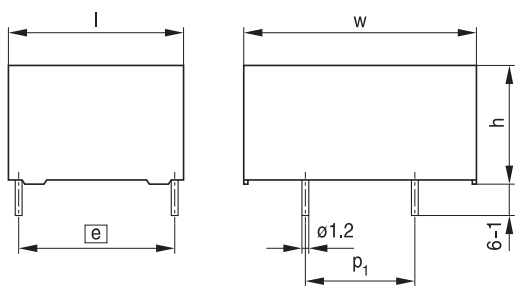

KMK1907-S

	B32776T	B32778T
Lead spacing $e \pm 0.4$ :	37.5	52.5
Lead diameter $d_1$ :	1.2	1.2

Dimensions in mm

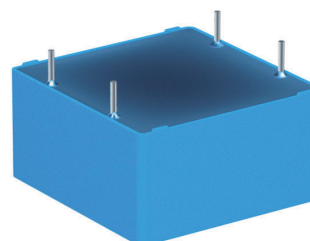

**Dimensional drawing 12-pin version**

**B32778J**

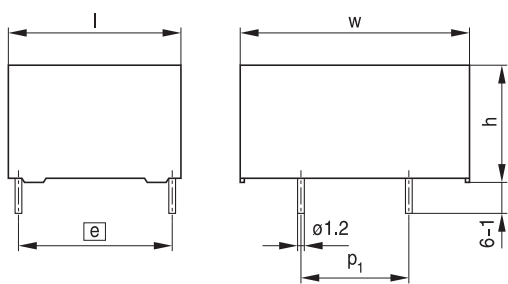

KMK1907-S

Lead spacing $e \pm 0.4$ :	52.5
Lead diameter $d_1$ :	1.2

Dimensions in mm

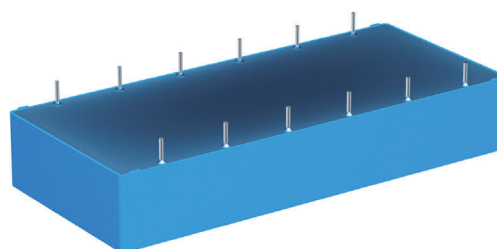



MKP DC link – high density series up to 480  $\mu\text{F}$

Overview of available types

Lead spacing	27.5 mm				37.5 mm					
Type	B32774				B32776					
Page	7				8					
$V_R$ (V DC)	450	800	1100	1300	450	575	800	900	1100	1300
$C_R$ ( $\mu\text{F}$ )										
1.5										
2.0										
2.7										
3.0										
3.3										
3.5										
3.9										
5.0										
6.8										
7.0										
7.5										
8.0										
8.5										
9.0										
10										
12										
13										
14										
15										
16										
20										
22										
25										
27										
30										
35										
40										
45										
50										
60										
65										

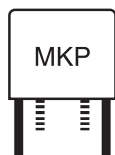

**B32774 ... B32778**

**MKP DC link – high density series up to 480  $\mu$ F**

### Overview of available types

Lead spacing	52.5 mm					
Type	B32778					
Page	11					
$V_R$ (V DC)	450	575	800	900	1100	1300
$C_R$ ( $\mu$ F)						
14						
20						
25						
27						
30						
35						
38						
40						
42						
45						
50						
55						
58						
60						
70						
75						
80						
90						
100						
110						
120						
130						
150						
170						
180						
200						
210						
270						
360						
480						

**Ordering codes and packing units (lead spacing 27.5 mm)**

$C_R$ <sup>1)</sup> $\mu\text{F}$	Max. dimensions $w \times h \times l$ mm	Ordering code (composition see below)	$I_{\text{RMS,max}}$ <sup>2)</sup> 70 °C 10 kHz A	$\text{ESR}_{\text{typ}}$ 70 °C 10 kHz m $\Omega$	$\text{ESL}_{\text{typ}}$ <sup>3)</sup> 70 °C 10 kHz nH	$\tan \delta$ 1 kHz $10^{-3}$	$\tan \delta$ 10 kHz $10^{-3}$	Un- taped pcs./ MOQ
<b><math>V_{\text{R},70\text{ °C}} = 450\text{ V DC}, V_{\text{op},85\text{ °C}} = 450\text{ V DC}</math></b>								
5.0	11.0 × 21.0 × 31.5	B32774D4505+000	5.0	21.1	19.0	1.2	10.7	2352
10.0	15.0 × 24.5 × 31.5	B32774D4106+000	8.0	10.9	24.0	1.2	11.0	1680
22.0	22.0 × 36.5 × 31.5	B32774D4226+000	14.5	5.4	30.0	1.3	12.1	784
<b><math>V_{\text{R},70\text{ °C}} = 800\text{ V DC}, V_{\text{op},85\text{ °C}} = 700\text{ V DC}</math></b>								
3.0	11.0 × 21.0 × 31.5	B32774D8305+000	4.5	24.8	19.0	0.9	7.6	2352
5.0	14.0 × 24.5 × 31.5	B32774D8505+000	6.5	15.3	23.0	0.9	7.7	1848
12.0	22.0 × 36.5 × 31.5	B32774D8126+000	13.0	6.8	34.0	1.0	8.3	784
<b><math>V_{\text{R},70\text{ °C}} = 1100\text{ V DC}, V_{\text{op},85\text{ °C}} = 920\text{ V DC}</math></b>								
2.0	12.5 × 21.5 × 31.5	B32774D0205+000	4.5	26.3	19.0	0.7	5.3	2100
3.3	18.0 × 27.5 × 31.5	B32774D0335+000	7.0	16.2	22.0	0.7	5.4	1428
5.0	19.0 × 30.0 × 31.5	B32774D0505+000	9.0	10.9	27.0	0.7	5.5	896
7.0	22.0 × 36.5 × 31.5	B32774D0705+000	12.0	8.1	30.0	0.7	5.8	784
<b><math>V_{\text{R},70\text{ °C}} = 1300\text{ V DC}, V_{\text{op},85\text{ °C}} = 1100\text{ V DC}</math></b>								
1.5	12.5 × 21.5 × 31.5	B32774D1155K000	4.4	31.3	20.0	0.6	4.8	2100
3.0	18.0 × 27.5 × 31.5	B32774D1305K000	7.0	16.0	24.0	0.6	4.9	1428
5.0	22.0 × 36.5 × 31.5	B32774D1505K000	10.5	9.8	33.0	0.7	5.1	784

MOQ = Minimum Order Quantity, consisting of 4 packing units.

Intermediate capacitance values are available on request.

**Composition of ordering code**

+ = Capacitance tolerance code:

J =  $\pm 5\%$

K =  $\pm 10\%$

Packing code:

000 = untaped (lead length 6 – 1 mm)

1) Capacitance value measured at 1 kHz

2) Max ripple current  $I_{\text{RMS}}$  at 70 °C, 10 kHz for  $\Delta T \leq 20\text{ °C}$  at  $\Delta \text{ESR}_{\text{typ}} \leq \pm 5\%$

3) Typical ESL value measured at resonance frequency (see specific graphs of Z versus frequency)

**B32776**
**MKP DC link – high density series – up to 480  $\mu$ F**
**Ordering codes and packing units (lead spacing 37.5 mm)**

$C_R^{1)}$ $\mu$ F	Max. dimensions $w \times h \times l$ mm	$P_1$ mm	Ordering code (composition see below)	$I_{RMS,max}^{2)}$ 70 °C 10 kHz A	$ESR_{typ}$ 70 °C 10 kHz m $\Omega$	$ESL_{typ}^{3)}$ 70 °C 10 kHz nH	$\tan \delta$ 1 kHz $10^{-3}$	$\tan \delta$ 10 kHz $10^{-3}$	Un- taped pcs./ MOQ
<b><math>V_{R,70\text{ °C}} = 450\text{ V DC}, V_{op,85\text{ °C}} = 450\text{ V DC}</math></b>									
12	24.0 × 15.0 × 41.5	–	B32776T4126K000	7.0	17.1	19.0	2.2	21.0	1040
16	24.0 × 19.0 × 41.5	–	B32776T4166K000	8.0	13.0	18.0	2.3	21.2	780
30	20.0 × 39.5 × 41.5	10.2	B32776G4306+000	14.0	7.0	11.0	2.3	21.3	640
30	20.0 × 39.5 × 41.5	–	B32776E4306+000	14.0	7.3	28.0	2.4	22.3	640
35	28.0 × 37.0 × 42.0	10.2	B32776G4356+000	16.5	6.0	10.0	2.3	21.4	440
35	28.0 × 37.0 × 42.0	–	B32776E4356+000	16.0	6.4	24.0	2.4	22.6	440
40	28.0 × 37.0 × 42.0	10.2	B32776G4406+000	17.5	5.3	11.0	2.3	21.4	440
40	28.0 × 37.0 × 42.0	–	B32776E4406+000	17.0	5.6	26.0	2.4	22.7	440
40	43.0 × 22.0 × 41.5	20.3	B32776T4406K000	17.0	5.2	13.0	2.3	21.2	280
50	28.0 × 42.5 × 41.5	10.2	B32776G4506+000	20.0	4.3	12.0	2.3	21.7	440
50	28.0 × 42.5 × 41.5	–	B32776E4506+000	19.0	4.7	30.0	2.5	23.8	440
60	30.0 × 45.0 × 42.0	20.3	B32776G4606+000	23.5	3.6	14.0	2.4	22.3	400
60	30.0 × 45.0 × 42.0	–	B32776E4606+000	22.0	4.0	32.0	2.5	24.2	400
65	33.0 × 48.0 × 42.0	20.3	B32776G4656+000	25.5	3.3	14.0	2.3	22.2	180
<b><math>V_{R,70\text{ °C}} = 575\text{ V DC}, V_{op,85\text{ °C}} = 500\text{ V DC}</math></b>									
8.5	24.0 × 15.0 × 41.5	–	B32776T5855+000	6.5	19.9	19.0	1.9	17.2	1040
12	24.0 × 19.0 × 41.5	–	B32776T5126K000	8.0	14.4	18.0	1.9	17.4	780
25	20.0 × 39.5 × 41.5	10.2	B32776G5256K000	14.0	7.0	12.0	1.9	17.5	640
25	20.0 × 39.5 × 41.5	–	B32776E5256K000	13.5	7.4	28.0	2.0	18.3	640
27	43.0 × 22.0 × 41.5	20.3	B32776T5276K000	15.5	6.4	14.0	1.9	17.5	280
30	28.0 × 37.0 × 42.0	10.2	B32776G5306K000	16.5	5.8	11.0	1.9	17.6	440
30	28.0 × 37.0 × 42.0	–	B32776E5306K000	16.5	6.1	26.0	2.0	18.5	440
35	28.0 × 42.5 × 41.5	10.2	B32776G5356+000	19.0	5.0	12.0	1.9	17.8	440
35	28.0 × 42.5 × 41.5	–	B32776E5356+000	18.0	5.3	29.0	2.0	19.0	440
45	30.0 × 45.0 × 42.0	20.3	B32776G5456K000	22.0	4.0	13.0	1.9	17.9	400
45	30.0 × 45.0 × 42.0	–	B32776E5456K000	21.0	4.4	32.0	2.1	19.7	400
50	33.0 × 48.0 × 42.0	20.3	B32776G5506K000	25.0	3.5	14.0	2.0	18.1	180

MOQ = Minimum Order Quantity, consisting of 4 packing units.

Intermediate capacitance values are available on request.

**Composition of ordering code**

+ = Capacitance tolerance code:

 J =  $\pm 5\%$ 

 K =  $\pm 10\%$ 

Packing code:

000 = untaped (lead length 6 – 1 mm)

1) Capacitance value measured at 1 kHz

 2) Max ripple current  $I_{RMS}$  at 70 °C, 10 kHz for  $\Delta T \leq 20\text{ °C}$  at  $\Delta ESR_{typ} \leq \pm 5\%$ 

3) Typical ESL value measured at resonance frequency (see specific graphs of Z versus frequency)



**Ordering codes and packing units (lead spacing 37.5 mm)**

$C_R^{1)}$ $\mu$ F	Max. dimensions $w \times h \times l$ mm	$P_1$ mm	Ordering code (composition see below)	$I_{RMS,max}^{2)}$ 70 °C 10 kHz A	$ESR_{typ}$ 70 °C 10 kHz m $\Omega$	$ESL_{typ}^{3)}$ 70 °C 10 kHz nH	$\tan \delta$ 1 kHz $10^{-3}$	$\tan \delta$ 10 kHz $10^{-3}$	Un- taped pcs./ MOQ
<b><math>V_{R,70\text{ °C}} = 800\text{ V DC}, V_{op,85\text{ °C}} = 700\text{ V DC}</math></b>									
6.8	24.0 × 15.0 × 41.5	–	B32776T8685+000	6.0	22.1	18.0	1.7	15.1	1040
8.5	24.0 × 19.0 × 41.5	–	B32776T8855+000	7.5	17.8	18.0	1.7	15.1	780
14	18.0 × 32.5 × 41.5	–	B32776E8146+000	10.0	11.5	23.0	1.8	16.3	720
15	20.0 × 39.5 × 41.5	10.2	B32776G8156+000	12.0	9.6	10.0	1.7	15.2	640
15	20.0 × 39.5 × 41.5	–	B32776E8156+000	11.5	10.3	24.0	1.7	15.7	640
20	28.0 × 37.0 × 42.0	10.2	B32776G8206+000	14.5	7.5	10.0	1.7	15.3	440
20	28.0 × 37.0 × 42.0	–	B32776E8206+000	14.5	7.8	24.0	1.7	15.9	440
20	43.0 × 22.0 × 41.5	20.3	B32776T8206K000	14.5	7.2	14.0	1.7	15.1	280
22	28.0 × 37.0 × 42.0	10.2	B32776G8226+000	15.5	6.8	11.0	1.7	15.3	440
22	28.0 × 37.0 × 42.0	–	B32776E8226+000	15.0	7.1	25.0	1.7	16.0	440
25	28.0 × 42.5 × 41.5	10.2	B32776G8256+000	17.0	6.1	11.0	1.7	15.4	440
25	28.0 × 42.5 × 41.5	–	B32776E8256+000	16.5	6.4	28.0	1.8	16.3	440
30	30.0 × 45.0 × 42.0	20.3	B32776G8306+000	19.5	5.1	12.0	1.7	15.6	400
30	30.0 × 45.0 × 42.0	–	B32776E8306+000	19.0	5.5	30.0	1.8	16.7	400
35	33.0 × 48.0 × 42.0	20.3	B32776G8356+000	22.0	4.3	14.0	1.7	15.7	180
<b><math>V_{R,70\text{ °C}} = 900\text{ V DC}, V_{op,85\text{ °C}} = 800\text{ V DC}</math></b>									
5	24.0 × 15.0 × 41.5	–	B32776T9505+000	5.5	26.1	19.0	1.5	13.4	1040
7.5	24.0 × 19.0 × 41.5	–	B32776T9755K000	7.5	17.8	18.0	1.5	13.5	780
15	20.0 × 39.5 × 41.5	10.2	B32776G9156K000	12.5	9.1	12.0	1.5	13.6	640
15	20.0 × 39.5 × 41.5	–	B32776E9156K000	12.0	9.4	28.0	1.5	14.1	640
16	43.0 × 22.0 × 41.5	20.3	B32776T9166K000	14.0	8.1	14.0	1.5	13.5	280
20	28.0 × 37.0 × 42.0	10.2	B32776G9206K000	15.0	7.0	11.0	1.5	13.6	440
20	28.0 × 37.0 × 42.0	–	B32776E9206K000	15.0	7.3	26.0	1.6	14.2	440
22	28.0 × 42.5 × 41.5	10.2	B32776G9226K000	17.0	6.3	12.0	1.5	13.7	440
22	28.0 × 42.5 × 41.5	–	B32776E9226K000	16.5	6.6	29.0	1.6	14.5	440
25	30.0 × 45.0 × 42.0	20.3	B32776G9256+000	19.0	5.5	13.0	1.5	13.8	400
25	30.0 × 45.0 × 42.0	–	B32776E9256+000	18.5	5.9	32.0	1.6	14.7	400
30	33.0 × 48.0 × 42.0	20.3	B32776G9306+000	21.5	4.7	14.0	1.5	13.9	180

MOQ = Minimum Order Quantity, consisting of 4 packing units.

Intermediate capacitance values are available on request.

**Composition of ordering code**

+ = Capacitance tolerance code:

J =  $\pm 5\%$

K =  $\pm 10\%$

Packing code:

000 = untaped (lead length 6 – 1 mm)

1) Capacitance value measured at 1 kHz

2) Max ripple current  $I_{RMS}$  at 70 °C, 10 kHz for  $\Delta T \leq 20\text{ °C}$  at  $\Delta ESR_{typ} \leq \pm 5\%$

3) Typical ESL value measured at resonance frequency (see specific graphs of Z versus frequency)



## B32776

MKP DC link – high density series – up to 480  $\mu\text{F}$

### Ordering codes and packing units (lead spacing 37.5 mm)

$C_R^{1)}$ $\mu\text{F}$	Max. dimensions $w \times h \times l$ mm	$P_1$ mm	Ordering code (composition see below)	$I_{\text{RMS,max}}^{2)}$ 70 °C 10 kHz A	$\text{ESR}_{\text{typ}}$ 70 °C 10 kHz m $\Omega$	$\text{ESL}_{\text{typ}}^{3)}$ 70 °C 10 kHz nH	$\tan \delta$ 1 kHz $10^{-3}$	$\tan \delta$ 10 kHz $10^{-3}$	Un- taped pcs./ MOQ
$V_{\text{R},70\text{ °C}} = 1100\text{ V DC}$ , $V_{\text{op},85\text{ °C}} = 920\text{ V DC}$									
3.9	24.0 × 15.0 × 41.5	–	B32776T0395+000	5.0	30.5	18.0	1.4	12.1	1040
5	24.0 × 19.0 × 41.5	–	B32776T0505+000	6.5	23.6	18.0	1.4	12.1	780
12	20.0 × 39.5 × 41.5	10.2	B32776G0126+000	12.0	10.2	12.0	1.4	12.2	640
12	20.0 × 39.5 × 41.5	–	B32776E0126+000	11.5	10.5	28.0	1.4	12.6	640
13	43.0 × 22.0 × 41.5	20.3	B32776T0136K000	13.0	8.9	14.0	1.4	12.1	280
14	28.0 × 37.0 × 42.0	10.2	B32776G0146+000	13.5	8.7	21.0	1.4	12.2	440
14	28.0 × 37.0 × 42.0	–	B32776E0146+000	13.5	9.0	25.0	1.4	12.6	440
16	28.0 × 42.5 × 41.5	10.2	B32776G0166+000	15.5	7.4	12.0	1.4	12.3	440
16	28.0 × 42.5 × 41.5	–	B32776E0166+000	15.0	7.8	30.0	1.4	12.9	440
20	30.0 × 45.0 × 42.0	20.3	B32776G0206+000	18.0	6.0	14.0	1.4	12.4	400
20	30.0 × 45.0 × 42.0	–	B32776E0206+000	17.5	6.5	32.0	1.4	13.1	400
22	33.0 × 48.0 × 42.0	20.3	B32776G0226+000	21.0	4.9	15.0	1.3	11.4	180
$V_{\text{R},70\text{ °C}} = 1300\text{ V DC}$ , $V_{\text{op},85\text{ °C}} = 1100\text{ V DC}$									
2.7	24.0 × 15.0 × 41.5	–	B32776T1275+000	5.0	34.7	19.0	1.1	9.6	1040
3.5	24.0 × 19.0 × 41.5	–	B32776T1355+000	6.0	27.4	18.0	1.1	9.7	780
8.0	20.0 × 39.5 × 41.5	10.2	B32776G1805+000	11.0	12.1	12.0	1.1	9.7	640
8.0	20.0 × 39.5 × 41.5	–	B32776E1805+000	10.5	12.4	24.0	1.2	10.0	640
9.0	43.0 × 22.0 × 41.5	20.3	B32776T1905K000	12.0	10.7	13.0	1.1	9.7	280
10	28.0 × 37.0 × 42.0	10.2	B32776G1106+000	13.0	9.6	11.0	1.1	9.7	440
10	28.0 × 37.0 × 42.0	–	B32776E1106+000	12.5	9.9	26.0	1.2	10.0	440
12	28.0 × 42.5 × 41.5	10.2	B32776G1126+000	14.5	8.1	12.0	1.1	9.8	440
12	28.0 × 42.5 × 41.5	–	B32776E1126+000	14.0	8.5	28.0	1.2	10.1	440
14	30.0 × 45.0 × 42.0	20.3	B32776G1146+000	17.0	6.8	14.0	1.1	10.1	400
14	30.0 × 45.0 × 42.0	–	B32776E1146+000	16.5	7.3	32.0	1.2	10.4	400
16	33.0 × 48.0 × 42.0	20.3	B32776G1166+000	19.0	6.0	15.0	1.1	9.9	180

MOQ = Minimum Order Quantity, consisting of 4 packing units.

Intermediate capacitance values are available on request.

#### Composition of ordering code

+ = Capacitance tolerance code:

J =  $\pm 5\%$

K =  $\pm 10\%$

Packing code:

000 = untaped (lead length 6 – 1 mm)

1) Capacitance value measured at 1 kHz

2) Max ripple current  $I_{\text{RMS}}$  at 70 °C, 10 kHz for  $\Delta T \leq 20\text{ °C}$  at  $\Delta \text{ESR}_{\text{typ}} \leq \pm 5\%$

3) Typical ESL value measured at resonance frequency (see specific graphs of Z versus frequency)

**Ordering codes and packing units (lead spacing 52.5 mm,  $P_1 = 20.3$  mm)**

$C_R^{1)}$	Max. dimensions $w \times h \times l$	Ordering code (composition see below)	$I_{RMS,max}^{2)}$ 70 °C 10 kHz A	$ESR_{typ}$ 70 °C 10 kHz m $\Omega$	$ESL_{typ}^{3)}$ 70 °C 10 kHz nH	$\tan \delta$ 1 kHz $10^{-3}$	$\tan \delta$ 10 kHz $10^{-3}$	Un- taped pcs./ MOQ
<b><math>V_{R,70\text{ °C}} = 450</math> V DC, <math>V_{op,85\text{ °C}} = 450</math> V DC</b>								
55	43.0 × 24.0 × 57.5	B32778T4556K000	16.5	7.2	13.0	4.3	41.7	560
75	30.0 × 45.0 × 57.5	B32778G4756+000	21.0	5.6	12.0	4.4	42.6	280
80	30.0 × 45.0 × 57.5	B32778G4806+000	21.5	5.3	13.0	4.4	42.7	280
100	35.0 × 50.0 × 57.5	B32778G4107+000	26.0	4.3	14.0	4.5	43.3	108
110	35.0 × 50.0 × 57.5	B32778G4117K000	27.0	3.9	15.0	4.5	43.6	108
150	130.0 × 24.0 × 57.5	B32778J4157K000	43.5	2.7	4.0	4.4	42.1	80
170	45.0 × 57.0 × 57.5	B32778G4177+000	36.5	2.6	17.0	4.6	45.7	140
180	60.0 × 45.0 × 57.5	B32778G4187+000	39.0	2.5	19.0	4.6	44.6	200
480	130.0 × 58.0 × 57.5	B32778J4487K000	79.5	0.9	6.0	4.8	45.4	40
<b><math>V_{R,70\text{ °C}} = 575</math> V DC, <math>V_{op,85\text{ °C}} = 500</math> V DC</b>								
40	43.0 × 24.0 × 57.5	B32778T5406K000	15.5	8.5	13.0	3.6	34.5	560
60	30.0 × 45.0 × 57.5	B32778G5606+000	20.5	5.8	13.0	3.7	35.3	280
80	35.0 × 50.0 × 57.5	B32778G5806+000	25.5	4.4	15.0	3.7	36.0	108
110	130.0 × 24.0 × 57.5	B32778J5117K000	40.5	3.0	5.0	3.6	34.5	80
120	45.0 × 57.0 × 57.5	B32778G5127+000	34.5	3.1	17.0	3.8	37.2	140
130	60.0 × 45.0 × 57.5	B32778G5137+000	36.5	2.8	19.0	3.8	36.7	200
360	130.0 × 58.0 × 57.5	B32778J5367K000	75.0	1.0	6.0	4.0	37.3	40
<b><math>V_{R,70\text{ °C}} = 800</math> V DC, <math>V_{op,85\text{ °C}} = 700</math> V DC</b>								
30	43.0 × 24.0 × 57.5	B32778T8306K000	14.5	9.8	14.0	3.2	30.2	560
45	30.0 × 45.0 × 57.5	B32778G8456+000	19.5	6.6	14.0	3.2	30.9	280
50	30.0 × 45.0 × 57.5	B32778G8506+000	20.0	6.3	13.0	3.2	30.9	280
55	35.0 × 50.0 × 57.5	B32778G8556+000	23.0	5.6	14.0	3.2	31.1	108
60	35.0 × 50.0 × 57.5	B32778G8606+000	23.5	5.1	15.0	3.3	31.2	108
80	130.0 × 24.0 × 57.5	B32778J8806K000	37.5	3.6	4.0	3.2	30.2	80
90	45.0 × 57.0 × 57.5	B32778G8906+000	32.5	3.5	17.0	3.3	32.2	140
100	60.0 × 45.0 × 57.5	B32778G8107+000	34.5	3.2	19.0	3.3	31.9	200
270	130.0 × 58.0 × 57.5	B32778J8277K000	70.5	1.2	6.0	3.5	32.4	40

MOQ = Minimum Order Quantity, consisting of 4 packing units.

Intermediate capacitance values are available on request.

**Composition of ordering code**

+ = Capacitance tolerance code:

J =  $\pm 5\%$

K =  $\pm 10\%$

Packing code:

000 = untaped (lead length 6 – 1 mm)

1) Capacitance value measured at 1 kHz

2) Max ripple current  $I_{RMS}$  at 70 °C, 10 kHz for  $\Delta T \leq 20$  °C at  $\Delta ESR_{typ} \leq \pm 5\%$

3) Typical ESL value measured at resonance frequency (see specific graphs of Z versus frequency)

**B32778**
**MKP DC link – high density series – up to 480  $\mu$ F**
**Ordering codes and packing units (lead spacing 52.5 mm,  $P_1 = 20.3$  mm)**

$C_R^{1)}$ $\mu$ F	Max. dimensions w × h × l mm	Ordering code (composition see below)	$I_{RMS,max}^{2)}$ 70 °C 10 kHz A	$ESR_{typ}$ 70 °C 10 kHz m $\Omega$	$ESL_{typ}^{3)}$ 70 °C 10 kHz nH	$\tan \delta$ 1 kHz 10 <sup>-3</sup>	$\tan \delta$ 10 kHz 10 <sup>-3</sup>	Un- taped pcs./ MOQ
<b><math>V_{R,70\text{ °C}} = 900</math> V DC, <math>V_{op,85\text{ °C}} = 800</math> V DC</b>								
25	43.0 × 24.0 × 57.5	B32778T9256K000	13.5	10.7	13.0	2.8	26.8	560
35	30.0 × 45.0 × 57.5	B32778G9356+000	18.0	7.7	13.0	2.9	27.3	280
50	35.0 × 50.0 × 57.5	B32778G9506K000	22.5	5.6	15.0	2.9	27.7	108
70	45.0 × 57.0 × 57.5	B32778G9706+000	31.0	3.8	18.0	3.0	28.5	140
70	130.0 × 24.0 × 57.5	B32778J9706K000	36.0	3.8	4.0	2.9	27.2	80
75	60.0 × 45.0 × 57.5	B32778G9756+000	32.5	3.6	20.0	2.9	28.2	200
210	130.0 × 58.0 × 57.5	B32778J9217K000	66.0	1.3	6.0	3.1	28.6	40
<b><math>V_{R,70\text{ °C}} = 1100</math> V DC, <math>V_{op,85\text{ °C}} = 920</math> V DC</b>								
20	43.0 × 24.0 × 57.5	B32778T0206K000	13.0	11.9	13.0	2.6	24.1	560
30	30.0 × 45.0 × 57.5	B32778G0306+000	17.5	8.2	13.0	2.6	24.5	280
40	35.0 × 50.0 × 57.5	B32778G0406+000	21.5	6.2	15.0	2.7	25.9	108
58	45.0 × 57.0 × 57.5	B32778G0586+000	29.0	4.3	17.0	2.7	25.4	140
60	60.0 × 45.0 × 57.5	B32778G0606+000	30.5	4.0	19.0	2.7	25.2	200
60	130.0 × 24.0 × 57.5	B32778J0606K000	34.5	4.1	4.0	2.7	25.1	80
200	130.0 × 58.0 × 57.5	B32778J0207K000	66.0	1.4	6.0	3.0	26.8	40
<b><math>V_{R,70\text{ °C}} = 1300</math> V DC, <math>V_{op,85\text{ °C}} = 1100</math> V DC</b>								
14	43.0 × 24.0 × 57.5	B32778T1146K000	12.0	13.8	13.0	2.1	19.5	560
20	30.0 × 45.0 × 57.5	B32778G1206+000	16.0	9.7	13.0	2.1	19.8	280
25	35.0 × 50.0 × 57.5	B32778G1256+000	19.0	7.8	15.0	2.1	19.9	108
27	35.0 × 50.0 × 57.5	B32778G1276+000	19.5	7.3	15.0	2.1	20.0	108
38	130.0 × 24.0 × 57.5	B32778J1386K000	31.5	5.1	4.0	2.1	19.5	80
40	45.0 × 57.0 × 57.5	B32778G1406+000	26.5	5.0	17.0	2.2	20.3	140
42	60.0 × 45.0 × 57.5	B32778G1426+000	28.0	4.7	19.0	2.2	20.2	200
120	130.0 × 58.0 × 57.5	B32778J1127K000	58.5	1.7	6.0	2.3	20.5	40

MOQ = Minimum Order Quantity, consisting of 4 packing units.

Intermediate capacitance values are available on request.

**Composition of ordering code**

+ = Capacitance tolerance code:

J =  $\pm 5\%$

K =  $\pm 10\%$

Packing code:

000 = untaped (lead length 6 – 1 mm)

1) Capacitance value measured at 1 kHz

2) Max ripple current  $I_{RMS}$  at 70 °C, 10 kHz for  $\Delta T \leq 20$  °C at  $\Delta ESR_{typ} \leq \pm 5\%$

3) Typical ESL value measured at resonance frequency (see specific graphs of Z versus frequency)



### Technical data

Reference standard: IEC 61071:2007. All data given at  $T = 20\text{ }^{\circ}\text{C}$ , unless otherwise specified.

Operating temperature range (case)	Max. operating temperature, $T_{\text{op,max}}$	+105 $^{\circ}\text{C}$				
	Upper category temperature $T_{\text{max}}$	+105 $^{\circ}\text{C}$				
	Lower category temperature $T_{\text{min}}$	-40 $^{\circ}\text{C}$				
Insulation resistance $R_{\text{ins}}$ given as time constant $\tau = C_{\text{R}} \cdot R_{\text{ins}}$ , rel. humidity $\leq 65\%$ (minimum as-delivered values)	$\tau > 10\,000\text{ s}$ (after 1 min.) For $V_{\text{R}} \geq 500\text{ V}$ measured at 500 V For $V_{\text{R}} < 500\text{ V}$ measured at $V_{\text{R}}$					
DC test voltage between terminals (10 s)	$1.5 \cdot V_{\text{R}}$					
Voltage test terminal to case (10 s)	2110 V AC, 50 Hz					
Pulse Handling Capability (V/ $\mu\text{s}$ )	$I_{\text{P}}$ (A) / C ( $\mu\text{F}$ )					
Reliability: Failure rate $\lambda$	10 fit ( $\leq 1 \cdot 10^{-9}/\text{h}$ ) at $0.5 \cdot V_{\text{R}}$ , 40 $^{\circ}\text{C}$ For conversion to other operating conditions and temperatures, refer to chapter "Quality, 2 Reliability".					
Service life $t_{\text{SL}}$	100 000 h at $V_{\text{R}}$ and 70 $^{\circ}\text{C}$					
$V_{\text{R}}$ (V DC)	450	575	800	900	1100	1300
Continuous operation voltage $V_{\text{op}}$ (V DC) at 70 $^{\circ}\text{C}$	450	575	800	900	1100	1300
Continuous operation voltage $V_{\text{op}}$ (V DC) at 85 $^{\circ}\text{C}$	450	500	700	800	920	1100
For temperatures between 85 $^{\circ}\text{C}$ and 105 $^{\circ}\text{C}$	1.33%/ $^{\circ}\text{C}$ of $V_{\text{op}}$ derating compared to $V_{\text{op}}$ at 85 $^{\circ}\text{C}$					

### Typical waveforms

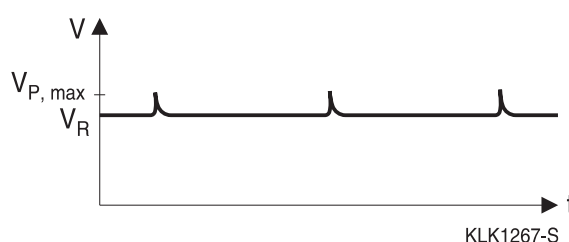
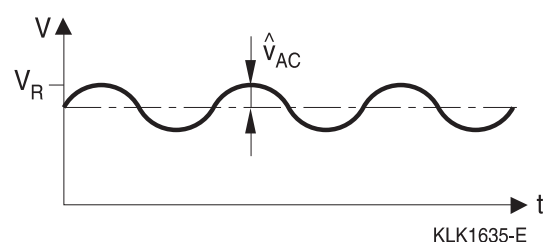

Restrictions:

$V_{\text{R}}$ : Maximum operating peak voltage of either polarity but of a non-reversing waveform, for which the capacitor has been designed for continuous operation.



**B32774 ... B32778**

**MKP DC link – high density series up to 480 μF**

$$\hat{V}_{AC} \leq 0.2 \cdot V_R$$

Overvoltage	Maximum duration within one day	Observation
1.1 · V <sub>R</sub>	30% of on-load duration	System regulation
1.15 · V <sub>R</sub>	30 min.	System regulation
1.2 · V <sub>R</sub>	5 min.	System regulation
1.3 · V <sub>R</sub>	1 min.	System regulation

NOTE 1 An overvoltage equal to 1.5 · V<sub>R</sub> for 30 ms is permitted 1000 times during the life of the capacitor.

The amplitudes of the overvoltages that may be tolerated without significant reduction in the life time of the capacitor depend on their duration, the number of application and the capacitor temperature.

In addition these values assume that the overvoltages may appear when the internal temperature of the capacitor is less than 0 °C but within the temperature category.

NOTE 2 The average applied voltage must not be higher than the specified voltage.

### Pulse handling capability

"dV/dt" represents the maximum permissible voltage change per unit of time for non-sinusoidal voltages, expressed in V/μs.

Note:

The values of dV/dt provided below must not be exceeded in order to avoid damaging the capacitor.

### dV/dt values

Lead spacing	27.5 mm				37.5 mm						52.5 mm					
Type	B32774				B32776						B32778					
V <sub>R</sub> (V DC)	450	800	1100	1300	450	575	800	900	1100	1300	450	575	800	900	1100	1300
dV/dt in V/μs	30	40	75	100	21	22	22	35	54	73	14	14	15	22	35	50

B32774

MKP DC link – high density series – up to 480  $\mu\text{F}$



### Characteristics curves

Additional technical information can be found under "Design support" on [www.epcos.com](http://www.epcos.com).

#### Impedance Z versus frequency f (typical values)

Lead spacing 27.5 mm

450 V DC

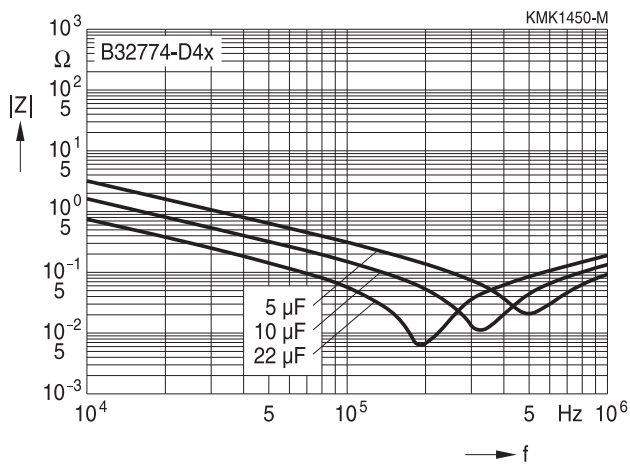

#### ESR versus frequency f (typical values)

Lead spacing 27.5 mm

450 V DC

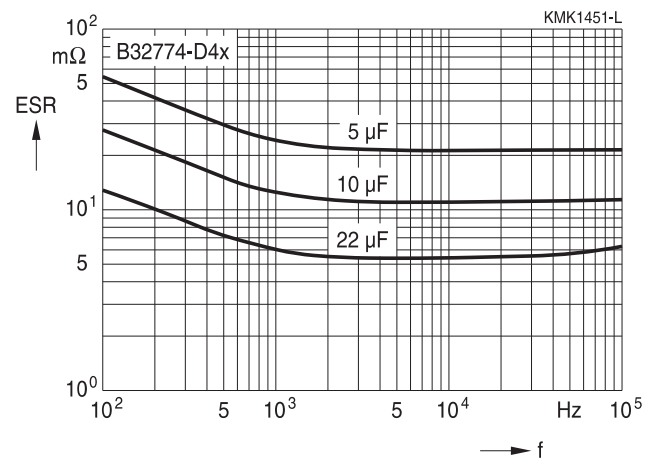

#### Impedance Z versus frequency f (typical values)

Lead spacing 27.5 mm

800 V DC

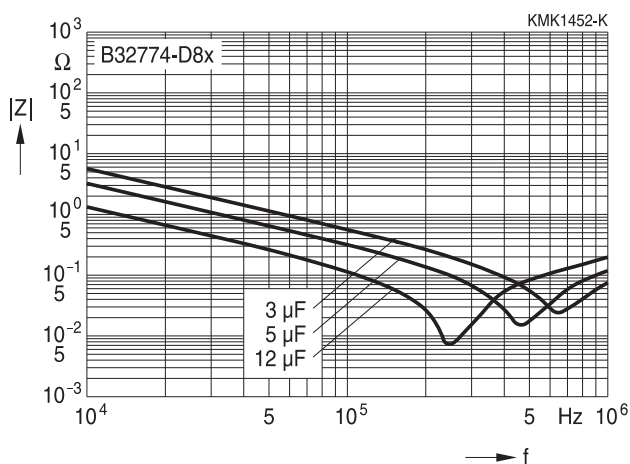

#### ESR versus frequency f (typical values)

Lead spacing 27.5 mm

800 V DC

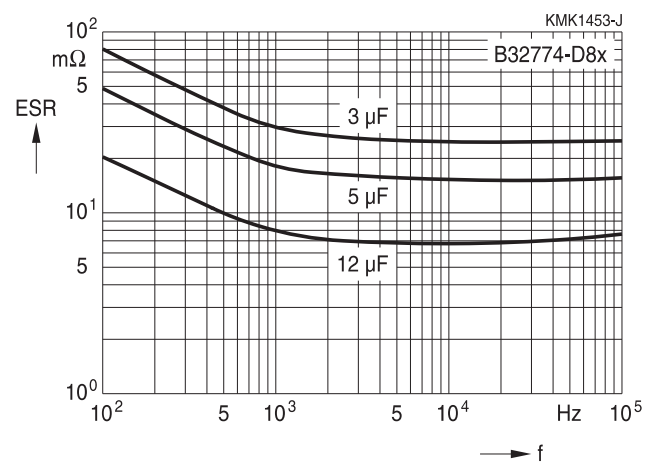



**B32774**

**MKP DC link – high density series – up to 480  $\mu\text{F}$**

**Characteristics curves**

Additional technical information can be found under "Design support" on [www.epcos.com](http://www.epcos.com).

**Impedance Z versus frequency f**  
(typical values)

**Lead spacing 27.5 mm**

1100 V DC

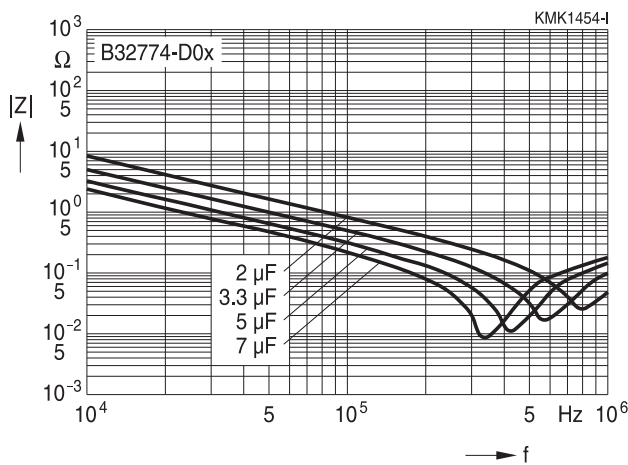

**ESR versus frequency f**  
(typical values)

**Lead spacing 27.5 mm**

1100 V DC

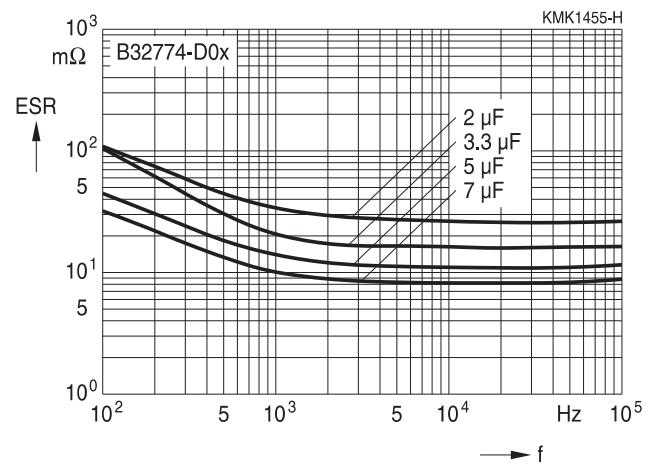

**Impedance Z versus frequency f**  
(typical values)

**Lead spacing 27.5 mm**

1300 V DC

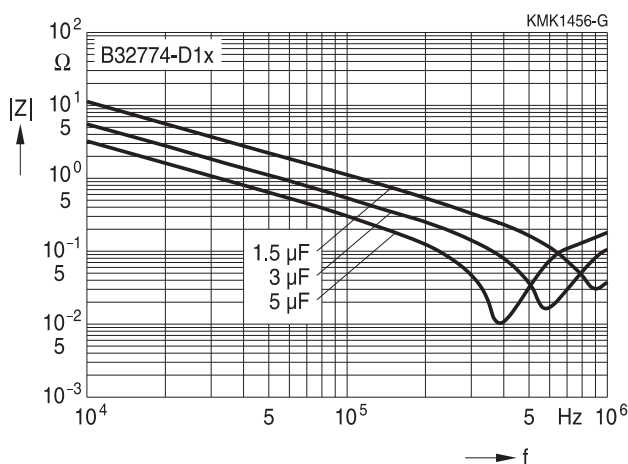

**ESR versus frequency f**  
(typical values)

**Lead spacing 27.5 mm**

1300 V DC

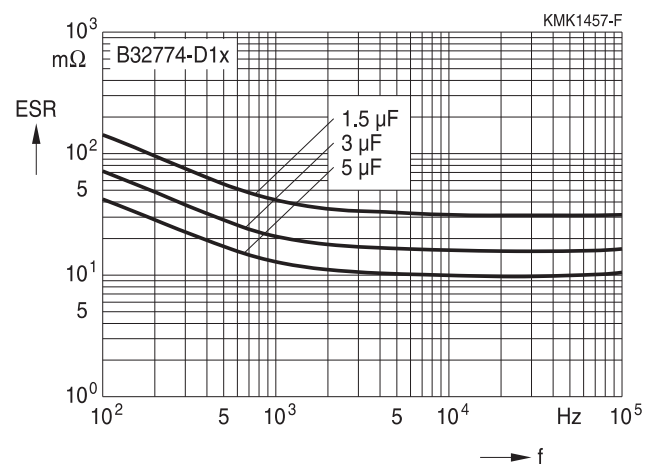



B32776

MKP DC link – high density series – up to 480  $\mu\text{F}$



### Characteristics curves

**Impedance  $Z$  versus frequency  $f$**   
(typical values)

**Lead spacing 37.5 mm**

450 V DC

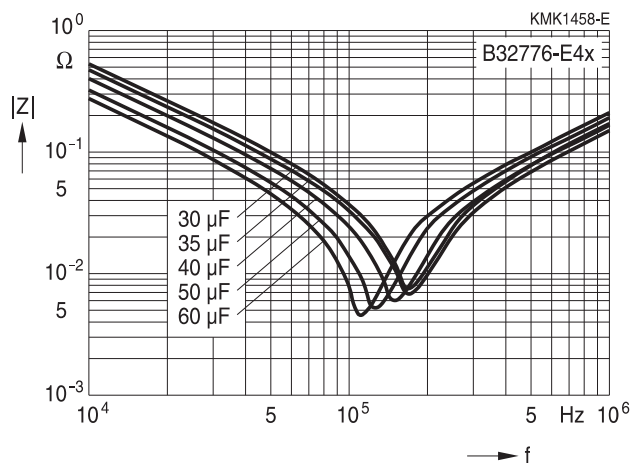

**ESR versus frequency  $f$**   
(typical values)

**Lead spacing 37.5 mm**

450 V DC

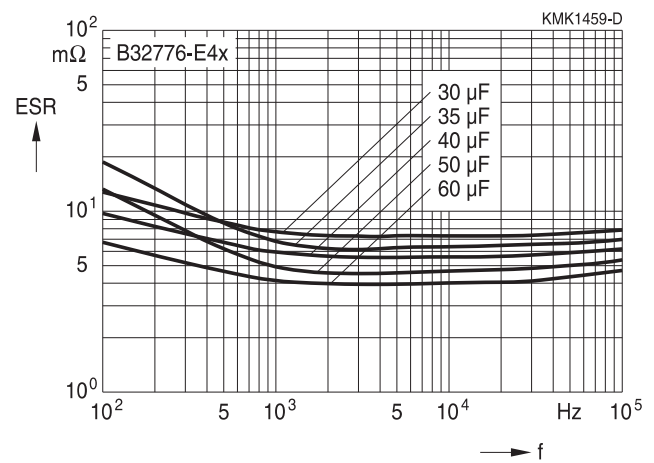

**Impedance  $Z$  versus frequency  $f$**   
(typical values)

**Lead spacing 37.5 mm**

450 V DC

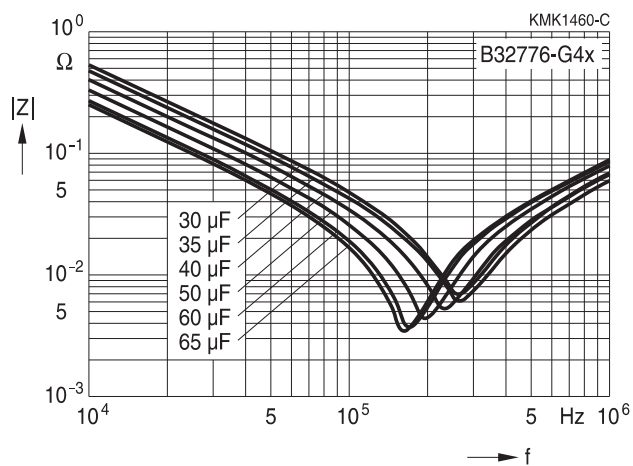

**ESR versus frequency  $f$**   
(typical values)

**Lead spacing 37.5 mm**

450 V DC

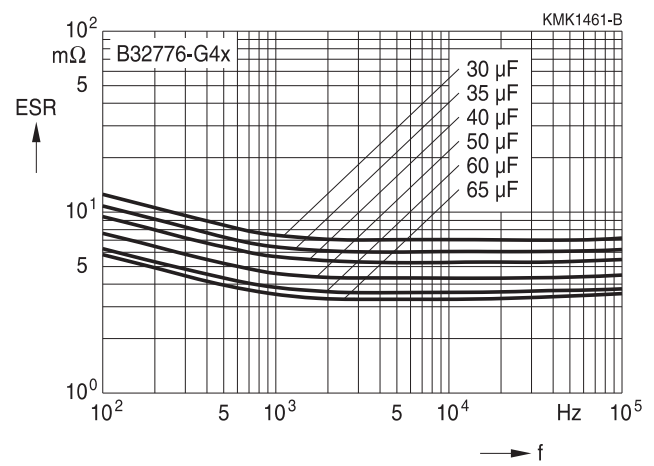



**B32776**

**MKP DC link – high density series – up to 480  $\mu\text{F}$**

**Characteristics curves**

**Impedance Z versus frequency f**  
(typical values)

**Lead spacing 37.5 mm**

**575 V DC**

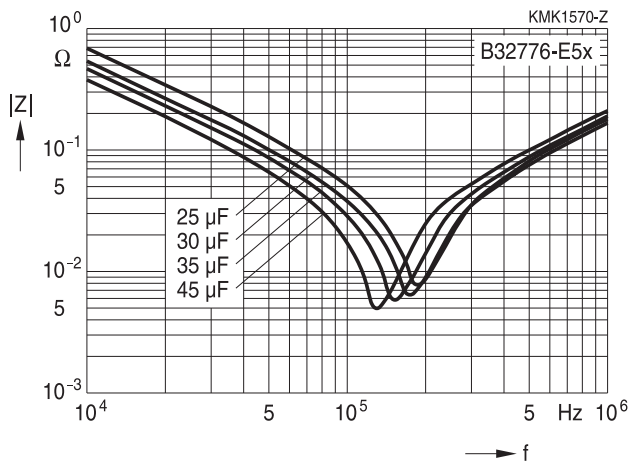

**ESR versus frequency f**  
(typical values)

**Lead spacing 37.5 mm**

**575 V DC**

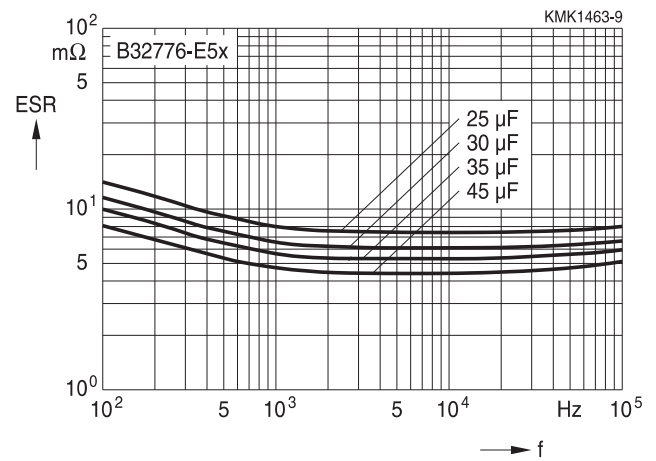

**Impedance Z versus frequency f**  
(typical values)

**Lead spacing 37.5 mm**

**575 V DC**

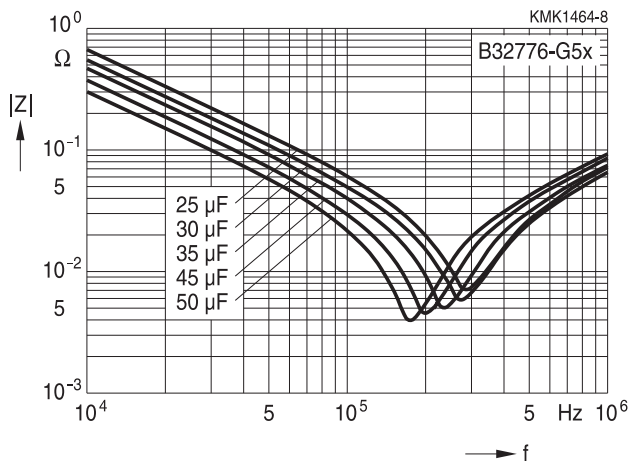

**ESR versus frequency f**  
(typical values)

**Lead spacing 37.5 mm**

**575 V DC**

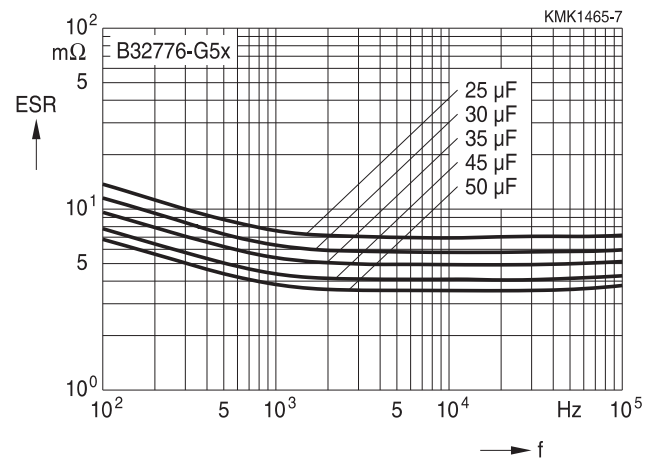

B32776

MKP DC link – high density series – up to 480  $\mu\text{F}$

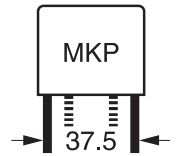

**Characteristics curves**

**Impedance Z versus frequency f**  
(typical values)

**Lead spacing 37.5 mm**

B32776E8\*/800 V DC

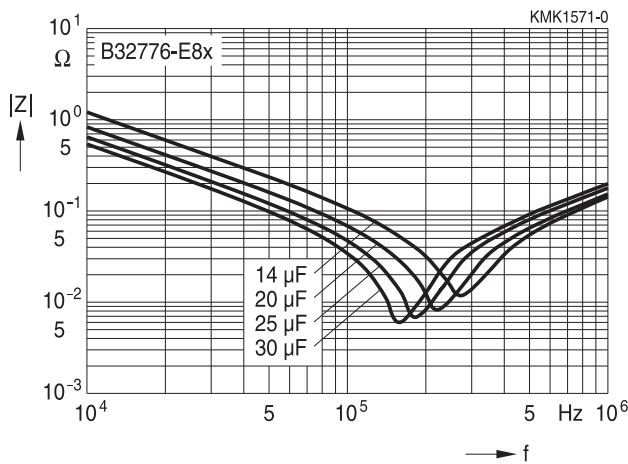

**ESR versus frequency f**  
(typical values)

**Lead spacing 37.5 mm**

B32776E8\*/800 V DC

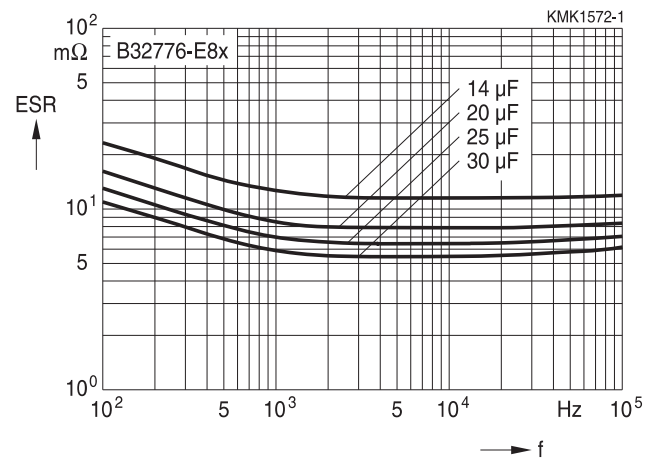

**Impedance Z versus frequency f**  
(typical values)

**Lead spacing 37.5 mm**

800 V DC

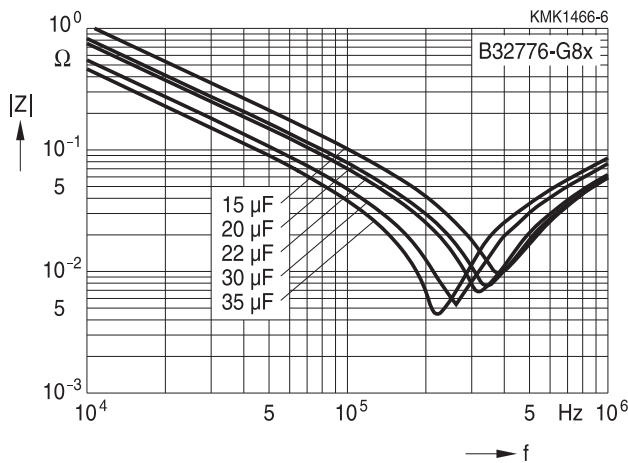

**ESR versus frequency f**  
(typical values)

**Lead spacing 37.5 mm**

800 V DC

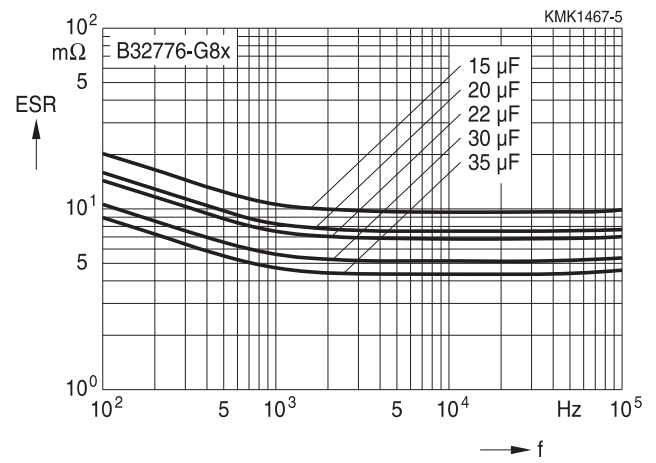



**B32776**

**MKP DC link – high density series – up to 480  $\mu\text{F}$**

**Characteristics curves**

**Impedance Z versus frequency f**  
(typical values)

**Lead spacing 37.5 mm**

**900 V DC**

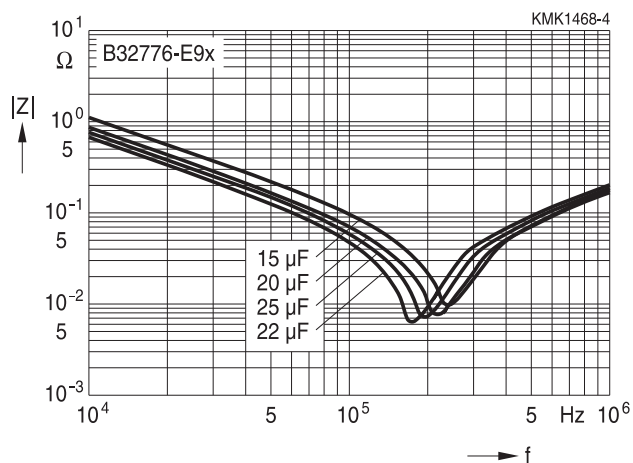

**ESR versus frequency f**  
(typical values)

**Lead spacing 37.5 mm**

**900 V DC**

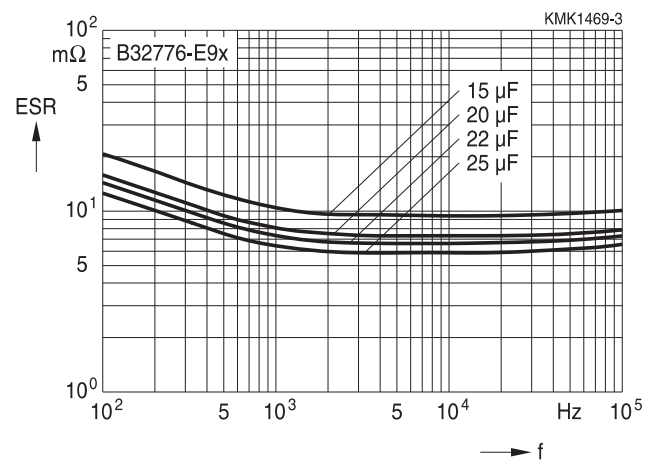

**Impedance Z versus frequency f**  
(typical values)

**Lead spacing 37.5 mm**

**900 V DC**

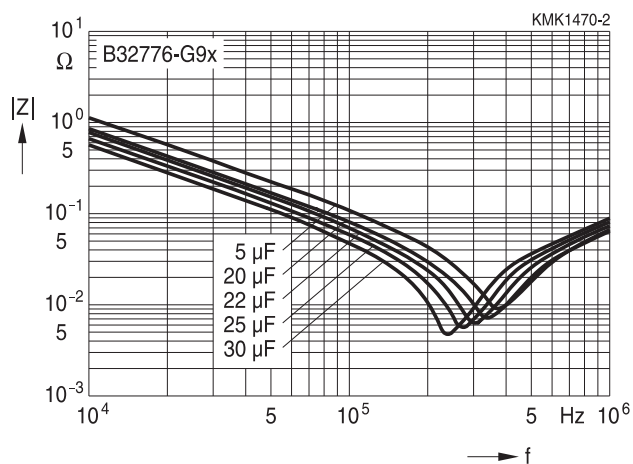

**ESR versus frequency f**  
(typical values)

**Lead spacing 37.5 mm**

**900 V DC**

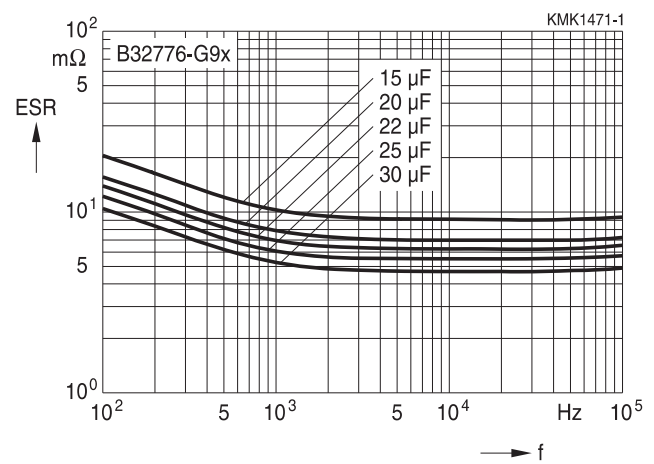

B32776

MKP DC link – high density series – up to 480  $\mu\text{F}$

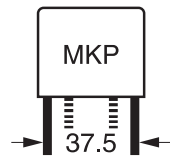

**Characteristics curves**

**Impedance Z versus frequency f**  
(typical values)

**Lead spacing 37.5 mm**

1100 V DC

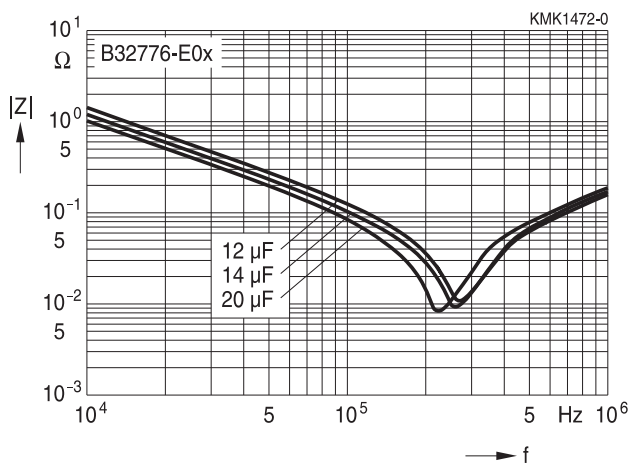

**ESR versus frequency f**  
(typical values)

**Lead spacing 37.5 mm**

1100 V DC

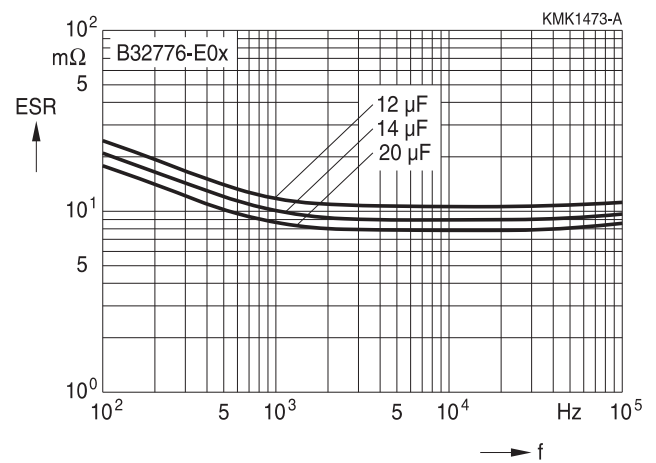

**Impedance Z versus frequency f**  
(typical values)

**Lead spacing 37.5 mm**

1100 V DC

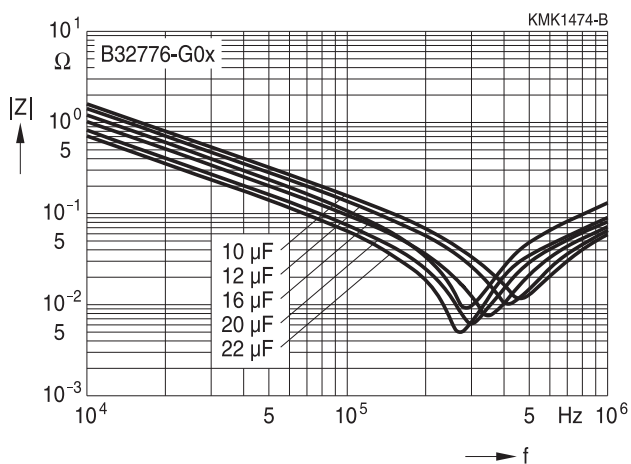

**ESR versus frequency f**  
(typical values)

**Lead spacing 37.5 mm**

1100 V DC

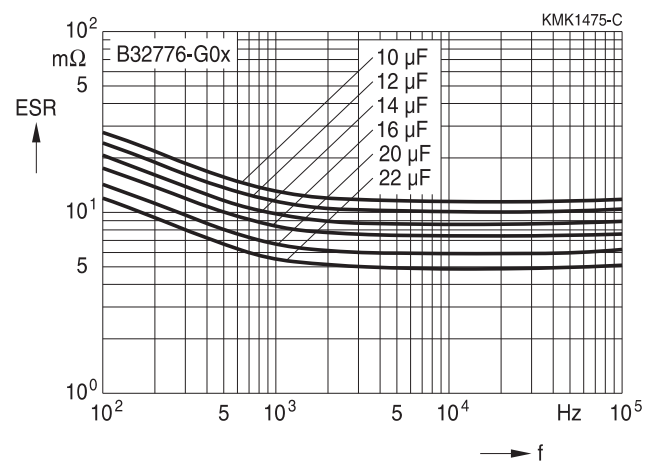



**B32776**

**MKP DC link – high density series – up to 480  $\mu\text{F}$**

**Characteristics curves**

**Impedance Z versus frequency f**  
(typical values)

**Lead spacing 37.5 mm**

1300 V DC

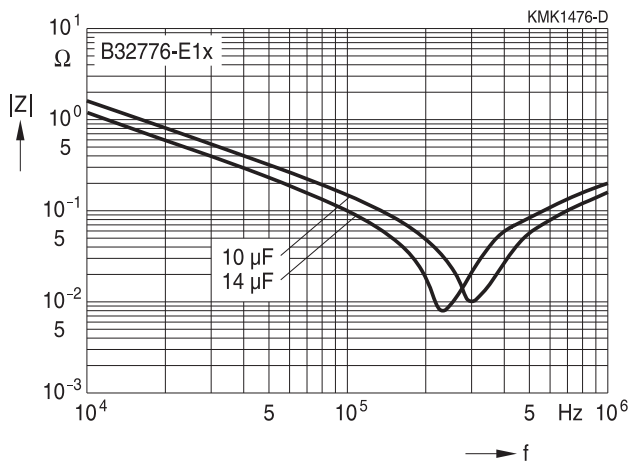

**ESR versus frequency f**  
(typical values)

**Lead spacing 37.5 mm**

1300 V DC

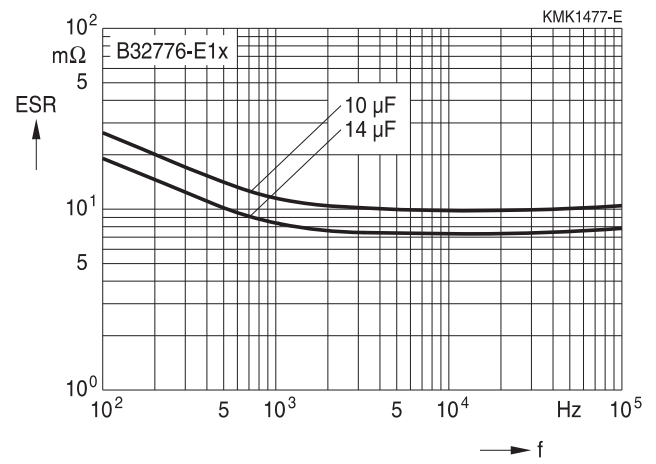

**Impedance Z versus frequency f**  
(typical values)

**Lead spacing 37.5 mm**

1300 V DC

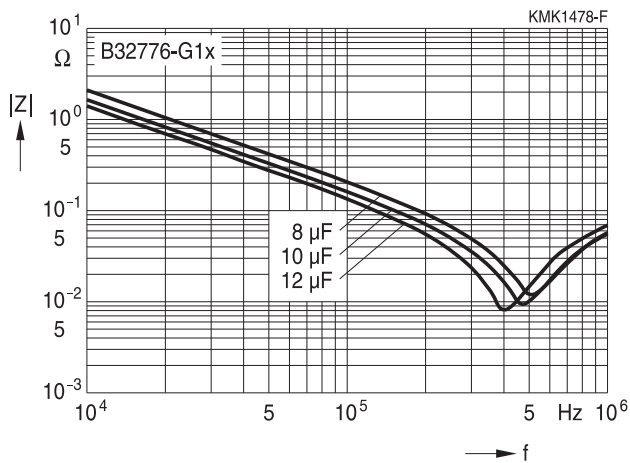

**ESR versus frequency f**  
(typical values)

**Lead spacing 37.5 mm**

1300 V DC

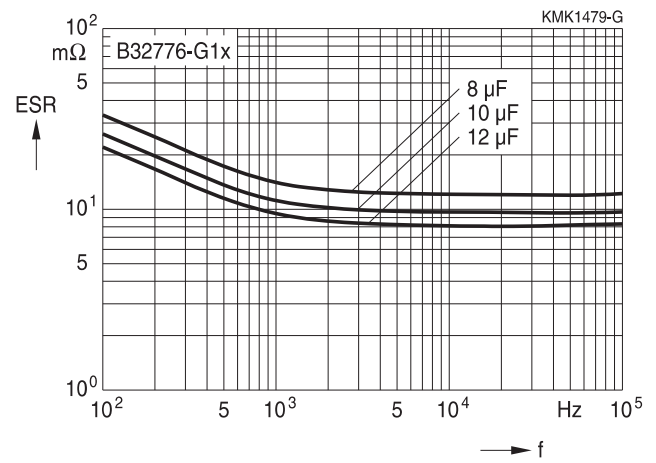

B32776

MKP DC link – high density series – up to 480  $\mu\text{F}$



**Characteristics curves**

**Impedance Z versus frequency f**  
(typical values)

**Lead spacing 37.5 mm (low profile, 2 pins)**

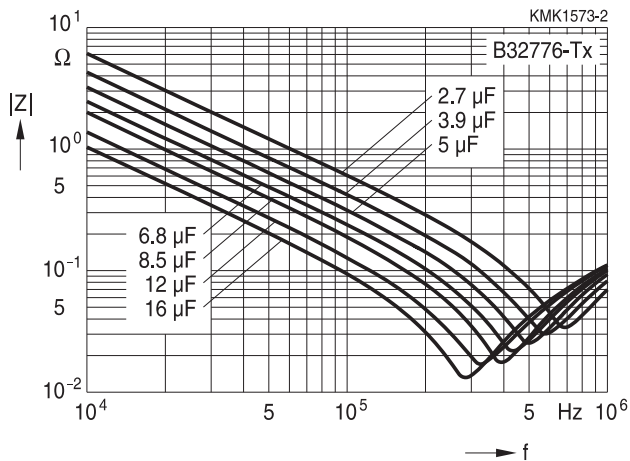

**ESR versus frequency f**  
(typical values)

**Lead spacing 37.5 mm (low profile, 2 pins)**

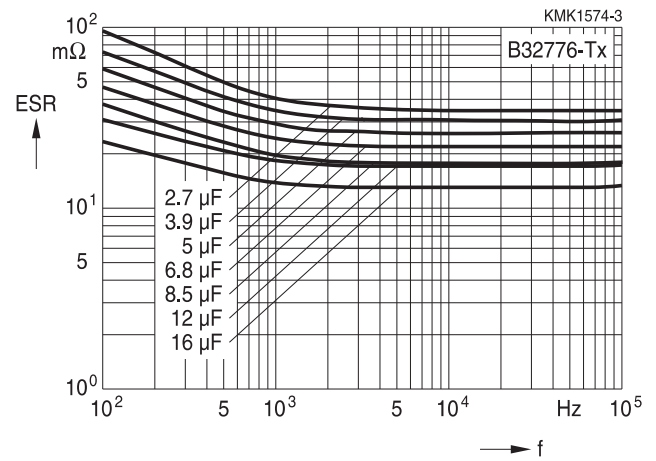

**Impedance Z versus frequency f**  
(typical values)

**Lead spacing 37.5 mm (low profile, 4 pins)**

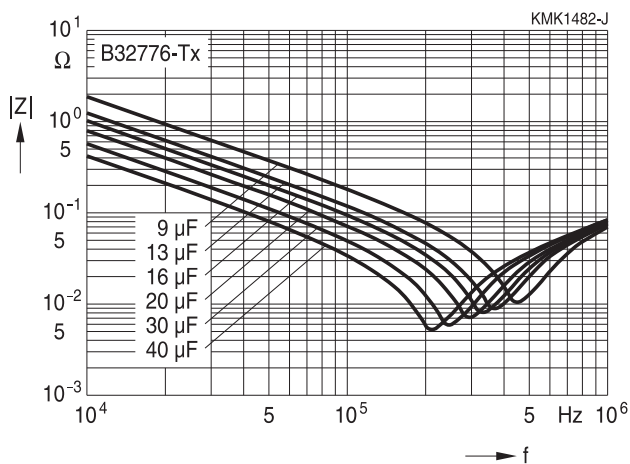

**ESR versus frequency f**  
(typical values)

**Lead spacing 37.5 mm (low profile, 4 pins)**

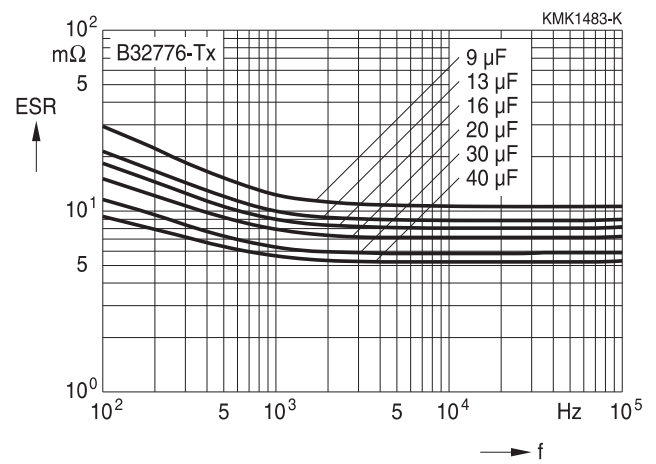



**B32778**

**MKP DC link – high density series – up to 480  $\mu\text{F}$**

**Characteristics curves**

**Impedance  $Z$  versus frequency  $f$**   
(typical values)

**Lead spacing 52.5 mm**

**450 V DC**

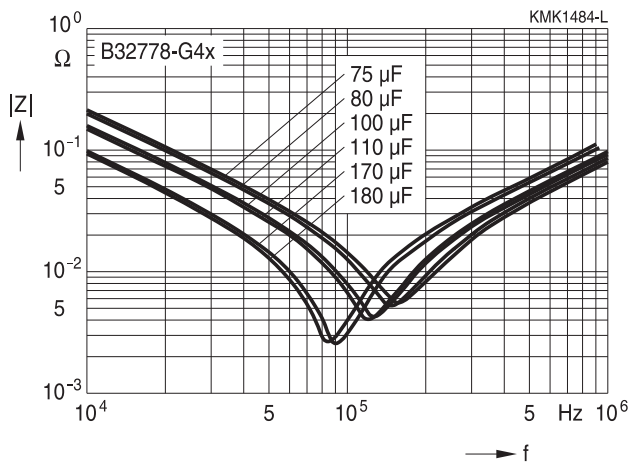

**ESR versus frequency  $f$**   
(typical values)

**Lead spacing 52.5 mm**

**450 V DC**

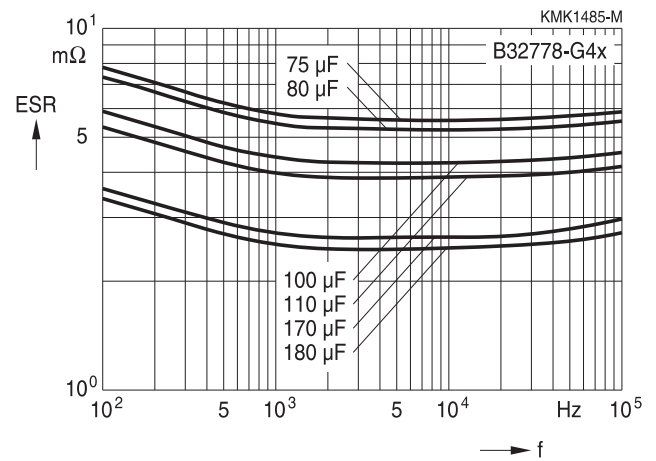

**Impedance  $Z$  versus frequency  $f$**   
(typical values)

**Lead spacing 52.5 mm**

**575 V DC**

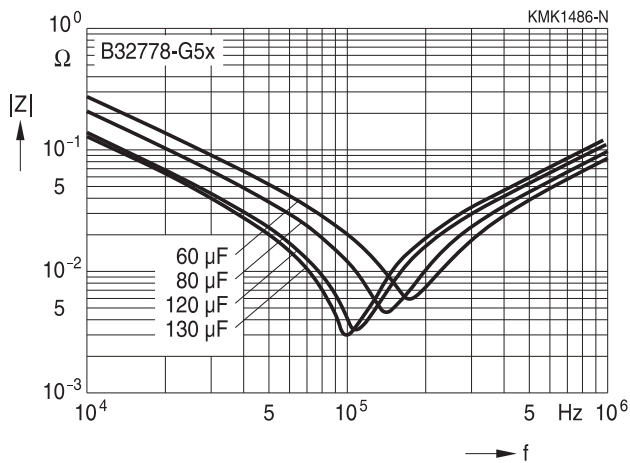

**ESR versus frequency  $f$**   
(typical values)

**Lead spacing 52.5 mm**

**575 V DC**

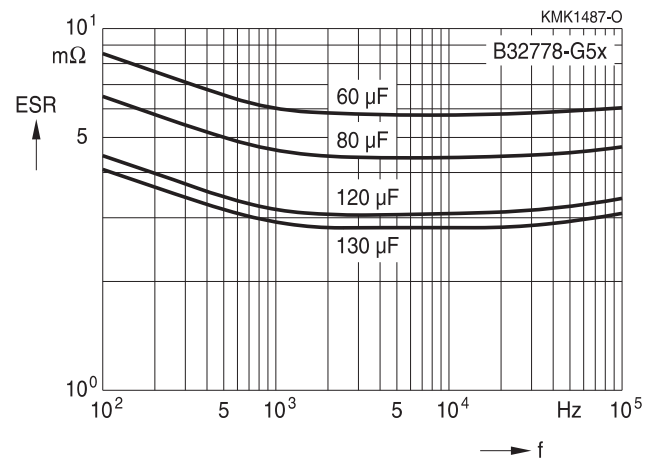



B32778

MKP DC link – high density series – up to 480  $\mu\text{F}$



**Characteristics curves**

**Impedance Z versus frequency f**  
(typical values)

**Lead spacing 52.5 mm**

800 V DC

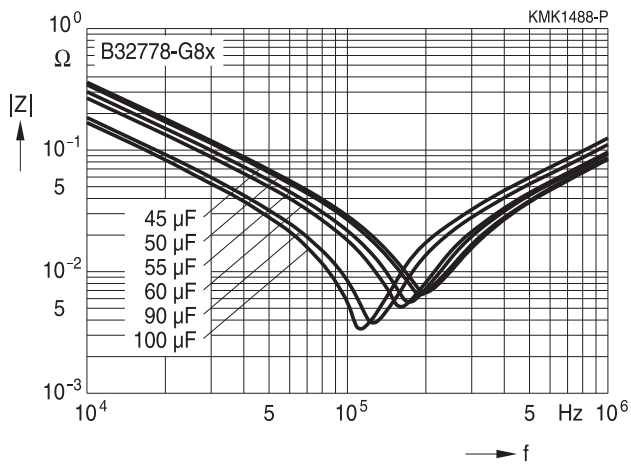

**ESR versus frequency f**  
(typical values)

**Lead spacing 52.5 mm**

800 V DC

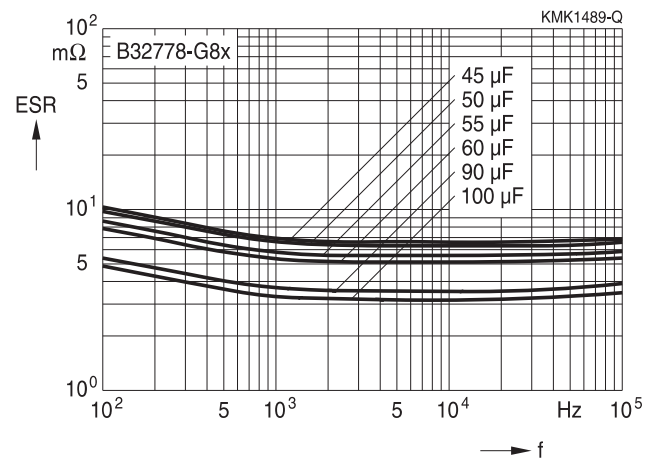

**Impedance Z versus frequency f**  
(typical values)

**Lead spacing 52.5 mm**

900 V DC

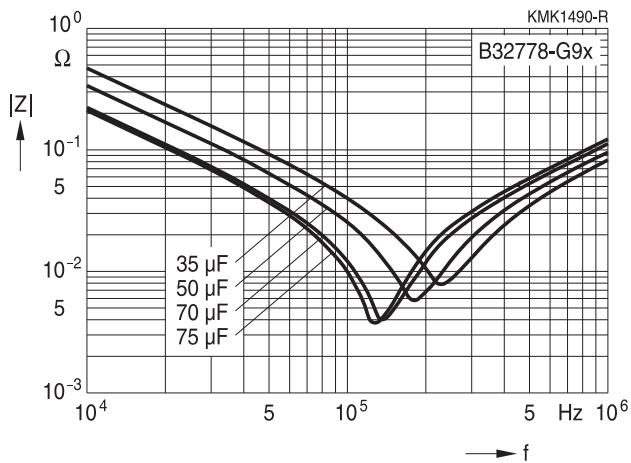

**ESR versus frequency f**  
(typical values)

**Lead spacing 52.5 mm**

900 V DC

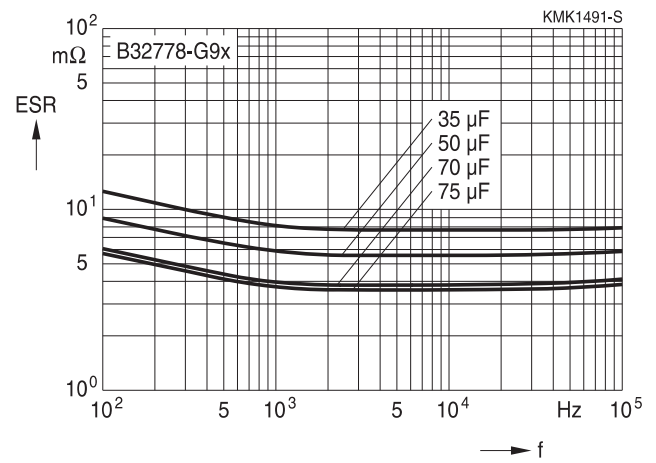

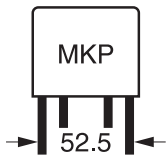

**B32778**

**MKP DC link – high density series – up to 480  $\mu\text{F}$**

**Characteristics curves**

**Impedance Z versus frequency f**  
(typical values)

**Lead spacing 52.5 mm**

**B32778G0\*/1100 V DC**

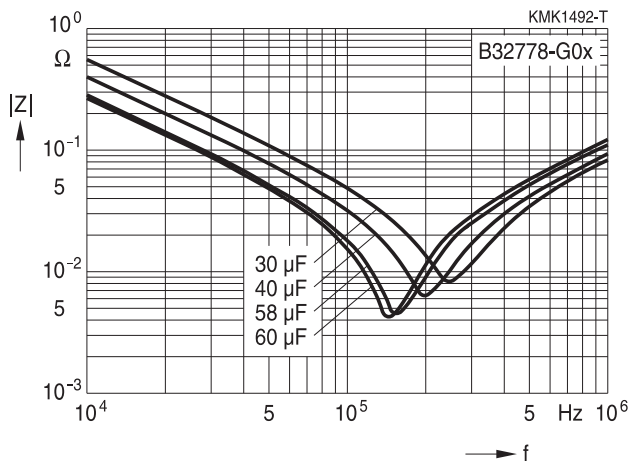

**ESR versus frequency f**  
(typical values)

**Lead spacing 52.5 mm**

**B32778G0\*/1100 V DC**

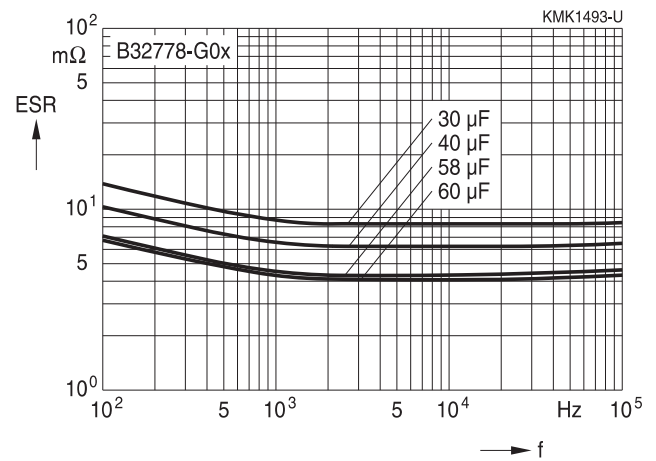

**Impedance Z versus frequency f**  
(typical values)

**Lead spacing 52.5 mm**

**1300 V DC**

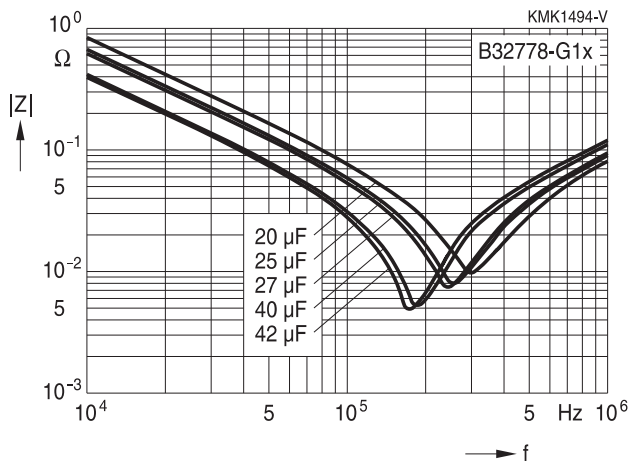

**ESR versus frequency f**  
(typical values)

**Lead spacing 52.5 mm**

**1300 V DC**

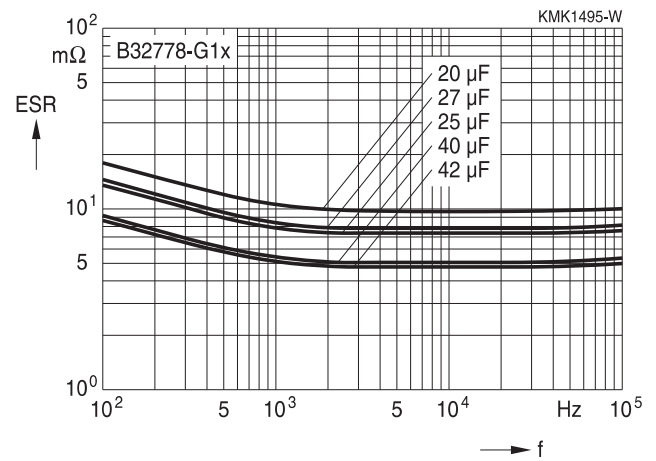

B32778

MKP DC link – high density series – up to 480  $\mu\text{F}$

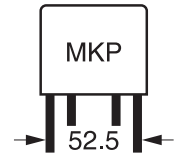

**Characteristics curves**

**Impedance Z versus frequency f**  
(typical values)

**Lead spacing 52.5 mm (low profile)**

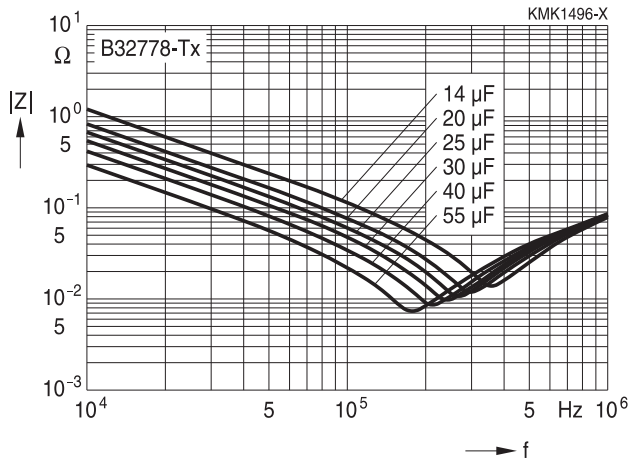

**ESR versus frequency f**  
(typical values)

**Lead spacing 52.5 mm (low profile)**

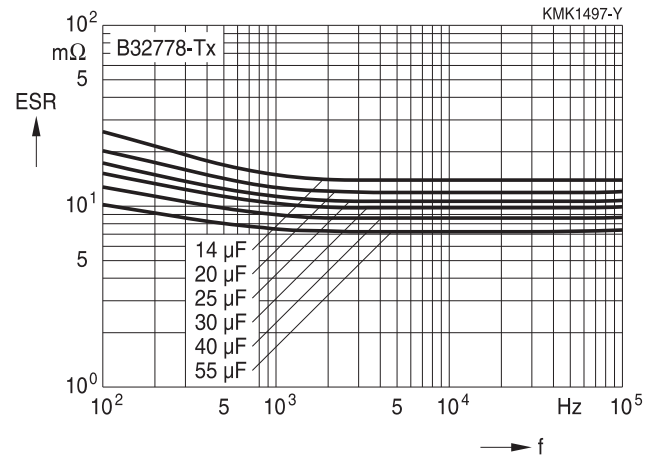

**Impedance Z versus frequency f**  
(typical values)

**Lead spacing 52.5 mm (12 pins)**

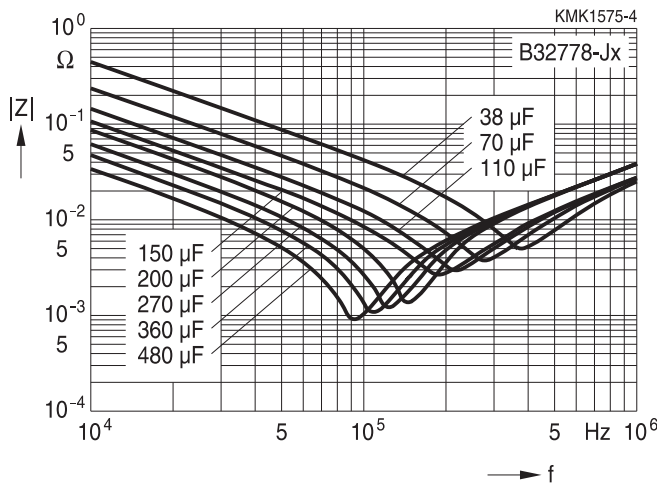

**ESR versus frequency f**  
(typical values)

**Lead spacing 52.5 mm (12 pins)**

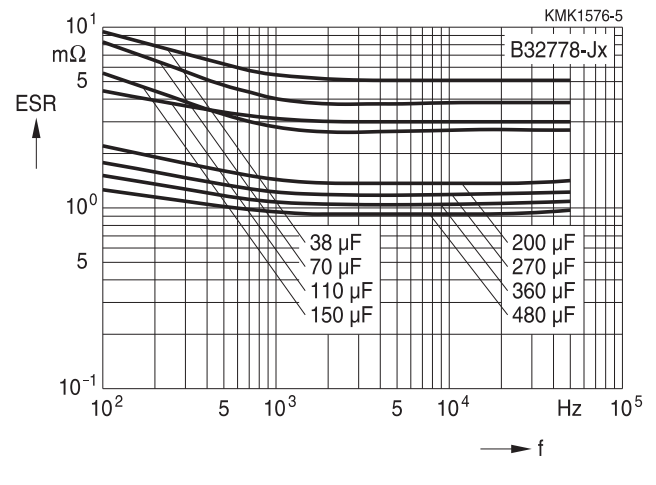

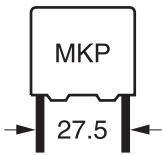

**B32774**

**MKP DC link – high density series – up to 480  $\mu$ F**

**Characteristics curves**

**Permissible current  $I_{RMS}$  versus frequency  $f$  at 70 °C**

**Lead spacing 27.5 mm**

**B32774D\***

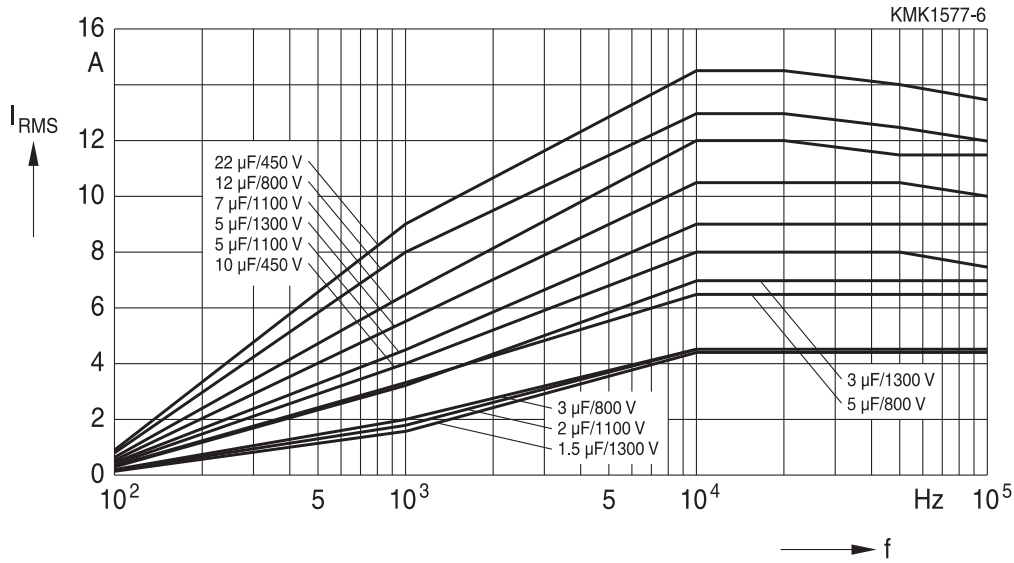

**B32776**

**MKP DC link – high density series – up to 480  $\mu$ F**



**Characteristics curves**

**Permissible current  $I_{RMS}$  versus frequency  $f$  at 70 °C**

**Lead spacing 37.5 mm**

**B32776E\***

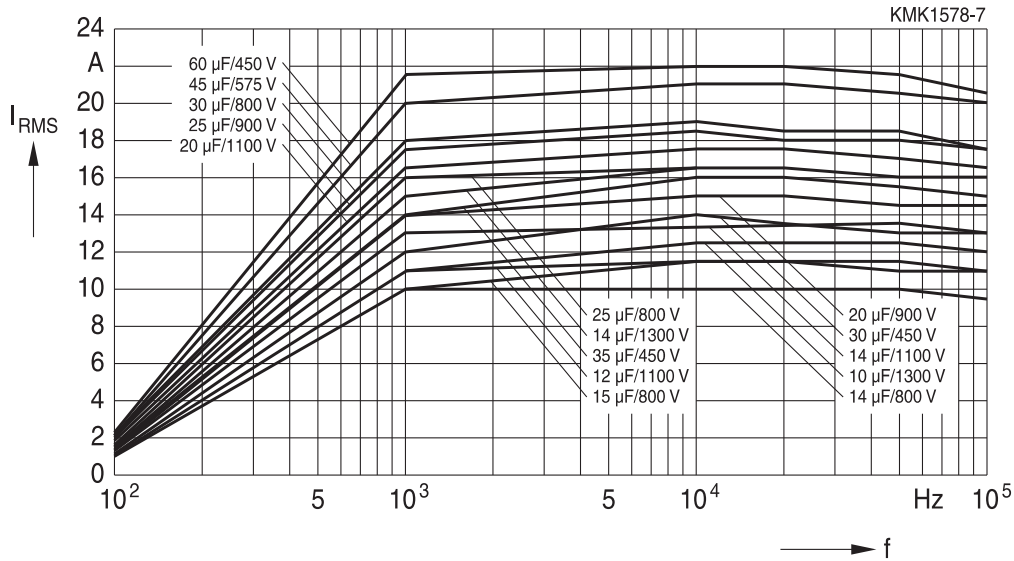

**B32776G\***

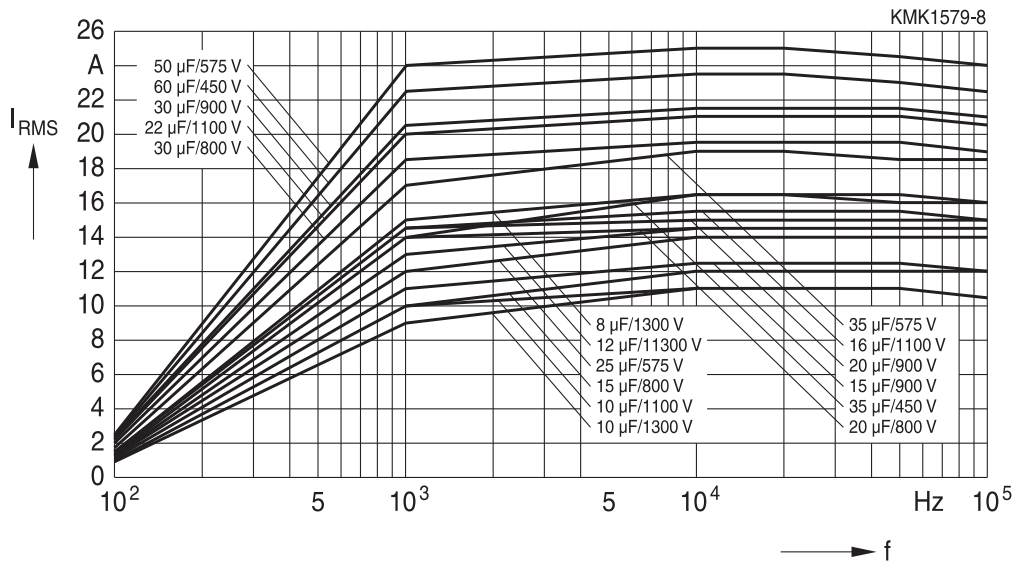



**B32776**

**MKP DC link – high density series – up to 480  $\mu$ F**

**Characteristics curves**

**Permissible current  $I_{RMS}$  versus frequency  $f$  at 70 °C**

**Lead spacing 37.5 mm**

**B32776T\***

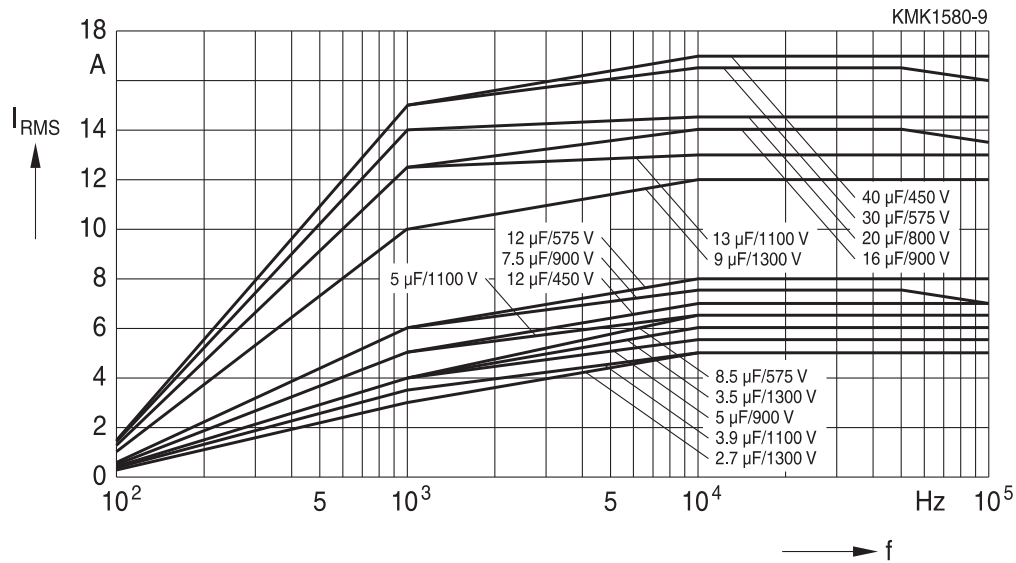

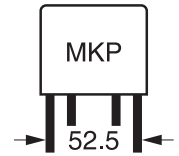

Characteristics curves

Permissible current  $I_{\text{RMS}}$  versus frequency  $f$  at 70 ° C

Lead spacing 52.5 mm

B32778G\* (4 pins)

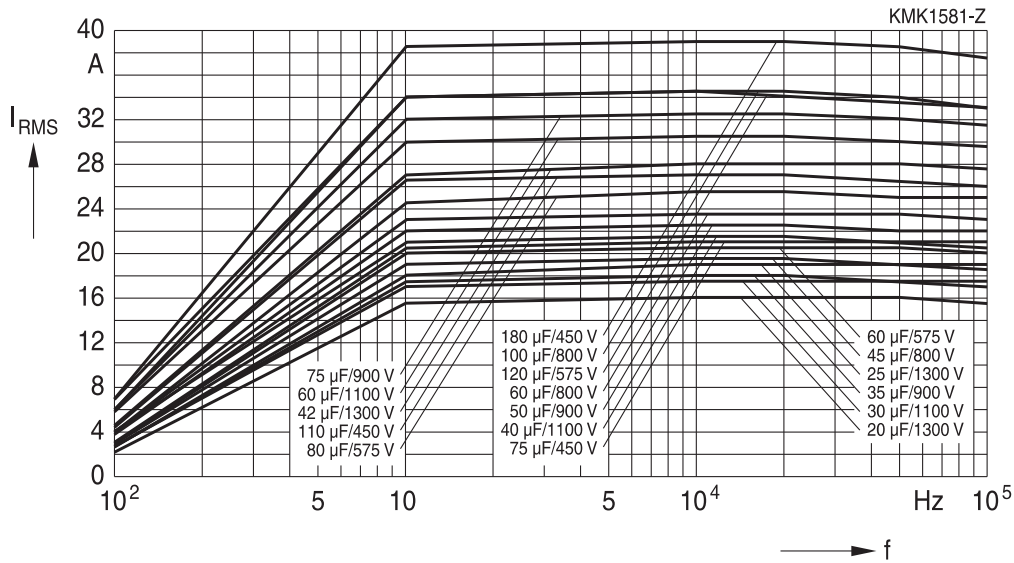

B32778T\* (4 pins)

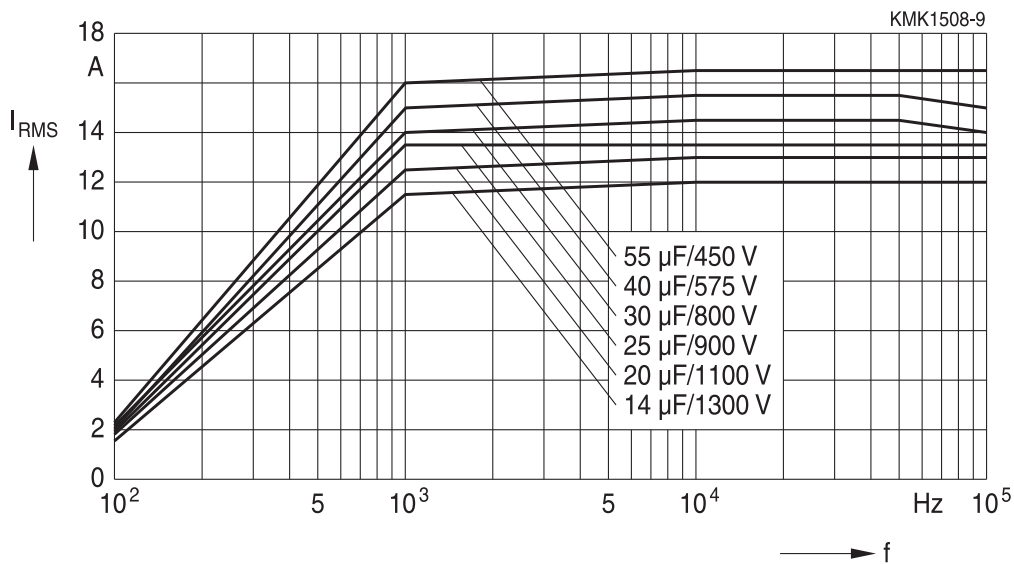



**B32778**

**MKP DC link – high density series – up to 480  $\mu\text{F}$**

**Characteristics curves**

**Permissible current  $I_{\text{RMS}}$  versus frequency  $f$  at 70 ° C**

**Lead spacing 52.5 mm**

**B32778J\* (12 pins)**

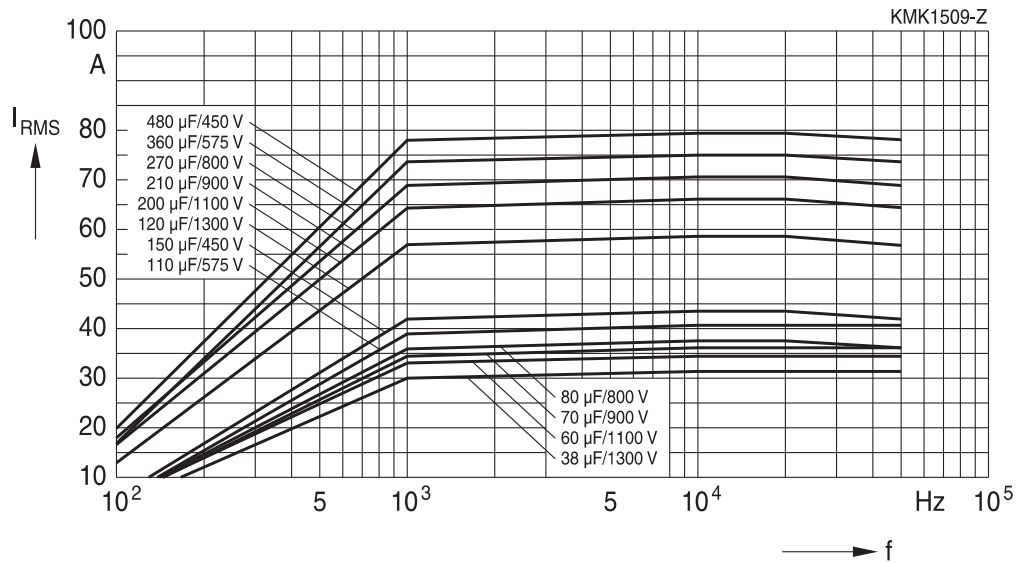



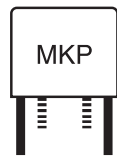

Curves characteristics ( $I_{\text{RMS}}$  derating versus temperature)

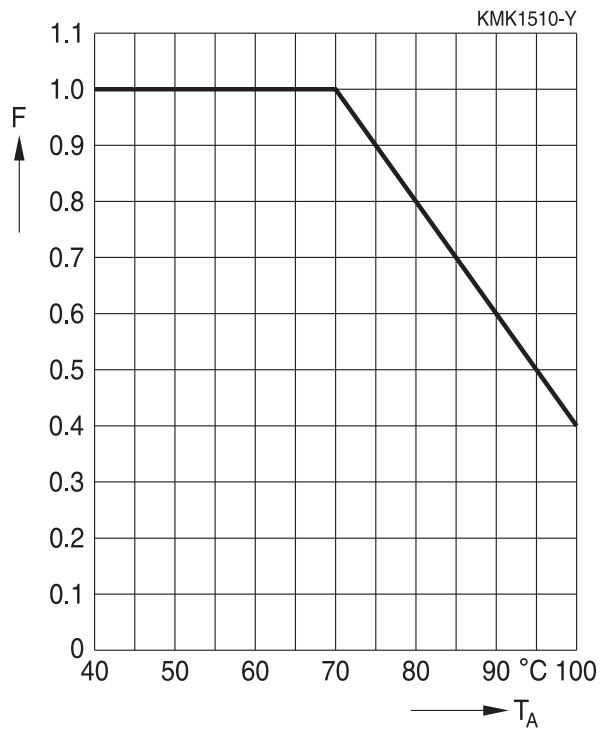

Maximum  $I_{\text{RMS}}$  current as function of the ambient temperature:  $I_{\text{RMS}}(T_A) = \text{Factor} \times I_{\text{RMS}}(70\text{ °C})$

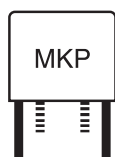

B32774 ... B32778

MKP DC link – high density series up to 480  $\mu\text{F}$

### Heat transference for self heating calculation



Figure 1

Box dimensions			Equivalent heat coefficient
w (mm)	h (mm)	l (mm)	G (mW/°C)
11.0	19.0	31.5	25
11.0	21.0	31.5	28
12.5	21.5	31.5	30
13.5	23.0	31.5	32
14.0	24.5	31.5	35
15.0	24.5	31.5	36
16.0	32.0	31.5	45
18.0	27.5	31.5	44
18.0	33.0	31.5	48
19.0	30.0	31.5	48
20.0	11.0	31.5	65
21.0	31.0	31.5	51
22.0	36.5	31.5	58
12.0	22.0	41.5	70
14.0	25.0	41.5	43
16.0	28.5	41.5	50
18.0	32.5	41.5	59
20.0	39.5	41.5	72
24.0	19.0	41.5	50
24.0	15.0	41.5	44
28.0	37.0	42.0	83
28.0	42.5	41.5	90
30.0	45.0	42.0	100
33.0	48.0	42.0	100
43.0	22.0	41.5	80
30.0	45.0	57.5	125
35.0	50.0	57.5	145
43.0	24.0	57.5	103
45.0	57.0	57.5	185
60.0	45.0	57.5	192
130.0	24.0	57.5	200
130.0	58.0	57.5	300

The equivalent heat coefficient "**G (mW/°C)**" is given for measuring the temperature on the lateral surface of the plastic box as figure1 shows. By using a thermocouple and avoiding effect of radiation and convection the temperature measured during operation conditions should be a result of the dissipated power divided by the equivalent heat coefficient.



### Self Heating by power dissipation & equivalent heat coefficient

The  $I_{RMS}$  and consequently the power dissipation must be limited during operation in order to not exceed the maximum limit of  $\Delta T$  allowed for this series.  $\Delta T_{max}$  given for this series is equal or lower than 20 °C at rated temperature (70 °C), for higher ambient temperatures  $\Delta T_{max}(T)$  will have the same derating factor than  $I_{RMS}$  versus temperature and then an equivalent derating as per: ambient temperatures  $\Delta T_{max}(T)$  will have the same derating factor than  $I_{RMS}$  versus temperature and then an equivalent derating as per:

$$\Delta T_{max}(T) = (\text{Factor})^2 \times \Delta T(70\text{ °C}).$$

For any particular  $I_{RMS}$  the  $\Delta T$  may be calculated by:

$$\Delta T(\text{°C}) = P_{dis}(\text{mW}) / G(\text{mW/°C}).$$

Where  $\Delta T(\text{°C})$  is the difference between the temperature measured on the box (see figure 1) and the ambient temperature when capacitor is working during normal operation;

$$\Delta T(\text{°C}) = T_{op}(\text{°C}) - T_A(\text{°C}).$$

It represents the increasing of temperature provoked by the  $I_{RMS}$  during operation.

$G(\text{mW/°C})$  is the equivalent heat coefficient described above and  $P_{dis}(\text{mW})$  is the dissipated power defined by:

$$P_{dis}(\text{mW}) = ESR_{typ}(\text{m}\Omega) \times I_{rms}^2(A_{RMS}).$$

### Example for thermal calculation:

We will take as reference B32778G0306K (30 μF/1100 V) type for thermal calculation.

Considering the following load and capacitor characteristics:

$I_{RMS} : 12 A_{RMS}$  at 20 kHz       $T_A : 85\text{ °C}$        $30 \times 45 \times 57.5$  box  
 $G(\text{mW/°C}) : 125$

Then we have to find the  $ESR_{typ}$  at 20 kHz what is approx . 8.2 mΩ.

So according to:

$$P_{dis}(\text{mW}) = ESR_{typ}(\text{m}\Omega) \times I_{rms}^2(A_{RMS})$$

we have the following:

$$P_{dis}(\text{mW}) = 8.2\text{ m}\Omega \times 12 A_{RMS}^2 = 1181\text{ mW}$$

and as per:

$$\Delta T(\text{°C}) = P_{dis}(\text{mW}) / G(\text{mW/°C})$$

we have the following:

$$\Delta T(\text{°C}) = 1181(\text{mW}) / 125(\text{mW/°C}) = 9.5\text{ °C}.$$

What is below of the

$$\Delta T_{max}(85\text{ °C}) = (\text{Factor})^2 \times \Delta T(70\text{ °C}) = (0.7)^2 \times 20\text{ °C} = 9.8\text{ °C}.$$

On the other hand we may confirm that max  $I_{RMS}$  at 20 kHz at 70 °C = 17.5  $A_{RMS}$

And then max  $I_{RMS}$  for 85 °C of ambient temperature is defined as follows:

$$I_{RMS}(85\text{ °C}) = \text{Factor} \times I_{RMS}(70\text{ °C}) = 0.7 \times 17.5 A_{RMS} = 12.25 A_{RMS}.$$

What confirms once again that  $I_{RMS}$  (12  $A_{RMS}$  at 20 kHz) is below the max specified for such frequency and ambient temperature.



**B32774 ... B32778**

**MKP DC link – high density series up to 480  $\mu\text{F}$**

**Life time expectancy - typical curves**

B3277x-4 (450 V DC)

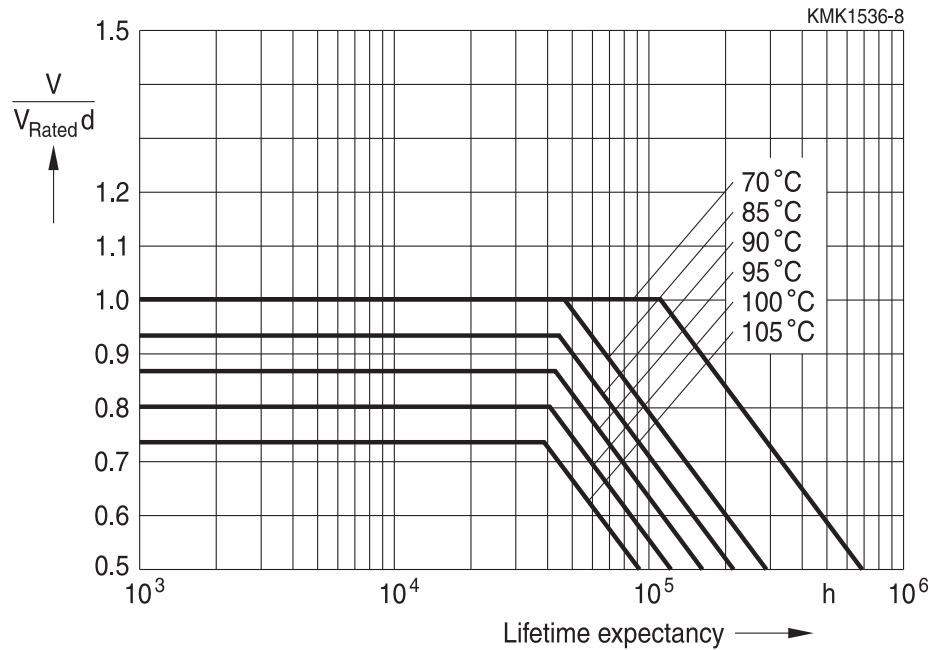

B3277x-5/8/9/0/1 (575 V DC / 800 V DC / 900 V DC / 1100 V DC / 1300 V DC)

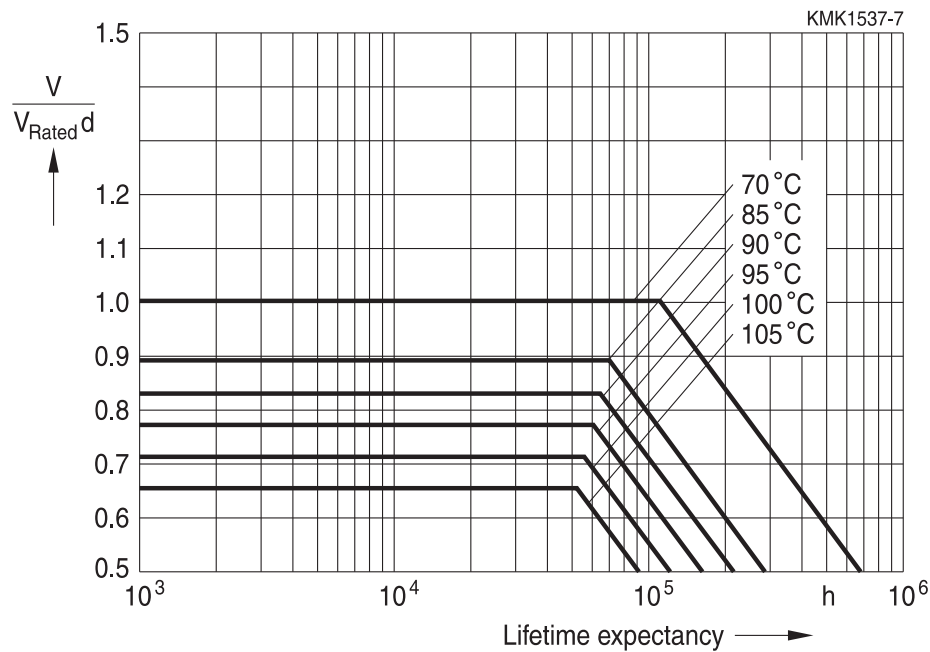

Note: Confidence level of 95%

**Testing and Standards**

Test	Reference	Conditions of test	Performance requirements
Electrical parameters (Routine test)	IEC61071:2007	Voltage between terminals, 1.5 $V_R$ , during 10 s Insulation resistance, $R_{ins}$ at $V_R$ if $V_R < 500$ V or 500 V if $V_R \geq 500$ V Capacitance, C at 1 kHz (room temperature) Dissipation factor, $\tan \delta$ at 1/10 kHz (room temperature)	Within specified limits
Robustness of terminations (Type test)	IEC 60068-2-21-2006	Tensile strength (test Ua1)	Capacitance and $\tan \delta$ within specified limits
		Wire diameter	
		0.5 < $d_1 \leq 0.8$ mm	10 N
		0.8 < $d_1 \leq 1.25$ mm	20 N
Resistance to soldering heat (Type test)	IEC 60068-2-20:2008, test Tb, method 1A	Solder bath temperature at 260 $\pm 5$ °C, immersion for 10 seconds	$\Delta C/C_0 \leq 2\%$ $ \Delta \tan \delta  \leq 0.002$
Rapid change of temperature (Type test)	IEC 60384-16:2005	$T_A$ = lower category temperature $T_B$ = upper category temperature Five cycles, duration $t = 30$ min.	$ \Delta C/C_0  \leq 2\%$ $ \Delta \tan \delta  \leq 0.002$ $R_{ins} \geq 50\%$ of initial limit
Vibration (Type test)	IEC 60384-16:2005	Test $F_C$ : vibration sinusoidal Displacement: 0.75 mm Acceleration: 98 $m/s^2$ Frequency: 10 Hz ... 500 Hz Test duration: 3 orthogonal axes, 2 hours each axe	No visible damage
Bump (Type test)	IEC 60384-16:2005	Test Eb: Total 4000 bumps with 390 $m/s^2$ mounted on PCB 6 ms duration	No visible damage $ \Delta C/C_0  \leq 2\%$ $ \Delta \tan \delta  \leq 0.002$ $R_{ins} \geq 50\%$ of initial limit
Climatic sequence (Type test)	IEC 60384-16:2005	Dry heat Tb / 16 h Damp heat cyclic, 1 <sup>st</sup> cycle +55 °C / 24 h / 95% ... 100% RH Cold Ta / 2 h Damp heat cyclic, 5 cycles +55 °C / 24 h / 95% ... 100% RH	No visible damage $ \Delta C/C_0  \leq 3\%$ $ \Delta \tan \delta  \leq 0.001$ $R_{ins} \geq 50\%$ of initial limit



**B32774 ... B32778**

**MKP DC link – high density series up to 480  $\mu$ F**

Test	Reference	Conditions of test	Performance requirements
Damp heat, steady state (Type test)	IEC 60384-16:2005	Test Ca 40 °C / 93% RH / 56 days	No visible damage $ \Delta C/C_0  \leq 5\%$ $ \Delta \tan \delta  \leq 0.005$ $R_{ins} \geq 50\%$ of initial limit
Endurance (Type test)	IEC 60384-16:2005	70 °C / 1.25 $V_R$ / 1000 hours or 85 °C / 1.25 $V_{op}$ / 1000 hours or 100 °C / 1.25 $V_{op}$ / 1000 hours	No visible damage $ \Delta C/C_0  \leq 5\%$ at 1 kHz $ \Delta \tan \delta  \leq 0.005$ $R_{ins} \geq 50\%$ of initial limit

## Mounting guidelines

### 1 Soldering

#### 1.1 Solderability of leads

The solderability of terminal leads is tested to IEC 60068-2-20, test Ta, method 1.

Before a solderability test is carried out, terminals are subjected to accelerated ageing (to IEC 60068-2-2, test Ba: 4 h exposure to dry heat at 155 °C). Since the ageing temperature is far higher than the upper category temperature of the capacitors, the terminal wires should be cut off from the capacitor before the ageing procedure to prevent the solderability being impaired by the products of any capacitor decomposition that might occur.

Solder bath temperature	235 $\pm$ 5 °C
Soldering time	2.0 $\pm$ 0.5 s
Immersion depth	2.0 +0/–0.5 mm from capacitor body or seating plane
Evaluation criteria:	
Visual inspection	Wetting of wire surface by new solder $\geq$ 90%, free-flowing solder

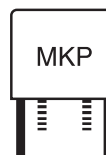

**MKP DC link – high density series up to 480  $\mu$ F**

**1.2 Resistance to soldering heat**

Resistance to soldering heat is tested to IEC 60068-2-20, test Tb, method 1.

Conditions:

Series	Solder bath temperature	Soldering time
MKT boxed (except 2.5 × 6.5 × 7.2 mm) coated uncoated (lead spacing >10 mm)	260 ±5 °C	10 ±1 s
MFP		
MKP (lead spacing >7.5 mm)		
MKT boxed (case 2.5 × 6.5 × 7.2 mm)	260 ±5 °C	5 ±1 s
MKP (lead spacing ≤7.5 mm)		<4 s
MKT uncoated (lead spacing ≤10 mm) insulated (B32559)		recommended soldering profile for MKT uncoated (lead spacing ≤ 10 mm) and insulated (B32559)

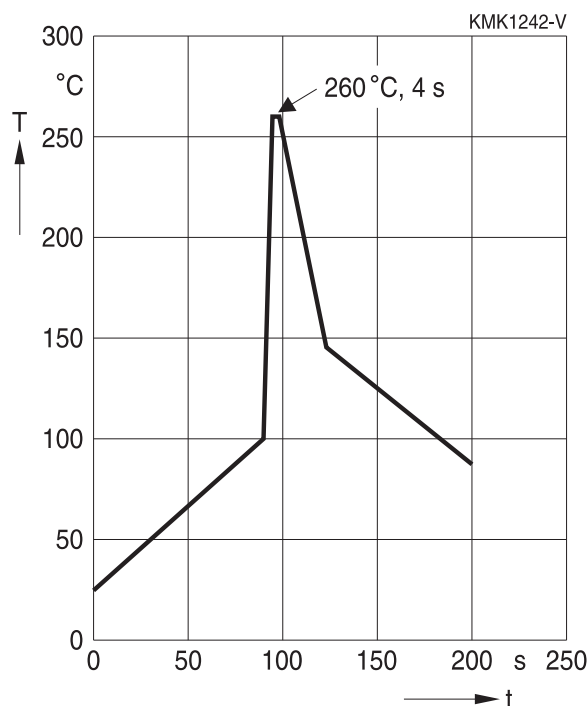

Immersion depth	2.0 +0/−0.5 mm from capacitor body or seating plane
Shield	Heat-absorbing board, (1.5 ±0.5) mm thick, between capacitor body and liquid solder
Evaluation criteria:	
Visual inspection	No visible damage
$\Delta C/C_0$	2% for MKT/MKP/MFP 5% for EMI suppression capacitors
$\tan \delta$	As specified in sectional specification



B32774 ... B32778

MKP DC link – high density series up to 480  $\mu\text{F}$

### 1.3 General notes on soldering

Permissible heat exposure loads on film capacitors are primarily characterized by the upper category temperature  $T_{\text{max}}$ . Long exposure to temperatures above this type-related temperature limit can lead to changes in the plastic dielectric and thus change irreversibly a capacitor's electrical characteristics. For short exposures (as in practical soldering processes) the heat load (and thus the possible effects on a capacitor) will also depend on other factors like:

- Pre-heating temperature and time
- Forced cooling immediately after soldering
- Terminal characteristics:  
diameter, length, thermal resistance, special configurations (e.g. crimping)
- Height of capacitor above solder bath
- Shadowing by neighboring components
- Additional heating due to heat dissipation by neighboring components
- Use of solder-resist coatings

The overheating associated with some of these factors can usually be reduced by suitable countermeasures. For example, if a pre-heating step cannot be avoided, an additional or reinforced cooling process may possibly have to be included.

#### EPCOS recommendations

As a reference, the recommended wave soldering profile for our film capacitors is as follows:



$T_s$ : Capacitor body maximum temperature at wave soldering

$T_p$ : Capacitor body maximum temperature at pre-heating

KMK1745-A-E



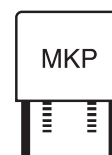

Body temperature should follow the description below:

- MKP capacitor
  - During pre-heating:  $T_p \leq 110 \text{ }^\circ\text{C}$
  - During soldering:  $T_s \leq 120 \text{ }^\circ\text{C}$ ,  $t_s \leq 45 \text{ s}$
- MKT capacitor
  - During pre-heating:  $T_p \leq 125 \text{ }^\circ\text{C}$
  - During soldering:  $T_s \leq 160 \text{ }^\circ\text{C}$ ,  $t_s \leq 45 \text{ s}$

When SMD components are used together with leaded ones, the film capacitors should not pass into the SMD adhesive curing oven. The leaded components should be assembled after the SMD curing step.

Leaded film capacitors are not suitable for reflow soldering.

In order to ensure proper conditions for manual or selective soldering, the body temperature of the capacitor ( $T_s$ ) must be  $\leq 120 \text{ }^\circ\text{C}$ .

One recommended condition for manual soldering is that the tip of the soldering iron should be  $< 360 \text{ }^\circ\text{C}$  and the soldering contact time should be no longer than 3 seconds.

For uncoated MKT capacitors with lead spacings  $\leq 10 \text{ mm}$  (B32560/B32561) the following measures are recommended:

- pre-heating to not more than  $110 \text{ }^\circ\text{C}$  in the preheater phase
- rapid cooling after soldering

Please refer to EPCOS Film Capacitor Data Book in case more details are needed.



**B32774 ... B32778**

**MKP DC link – high density series up to 480  $\mu$ F**

### Cautions and warnings

- Do not exceed the upper category temperature (UCT).
- Do not apply any mechanical stress to the capacitor terminals.
- Avoid any compressive, tensile or flexural stress.
- Do not move the capacitor after it has been soldered to the PC board.
- Do not pick up the PC board by the soldered capacitor.
- Do not place the capacitor on a PC board whose PTH hole spacing differs from the specified lead spacing.
- Do not exceed the specified time or temperature limits during soldering.
- Avoid external energy inputs, such as fire or electricity.
- Avoid overload of the capacitors.
- Consult us if application is with severe temperature and humidity condition.
- There are no serviceable or repairable parts inside the capacitor. Opening the capacitor or any attempts to open or repair the capacitor will void the warranty and liability of EPCOS.
- Please note that the standards referred to in this publication may have been revised in the meantime.

The table below summarizes the safety instructions that must always be observed. A detailed description can be found in the relevant sections of the chapters "General technical information" and "Mounting guidelines".

Topic	Safety information	Reference chapter "General technical information"
Storage conditions	Make sure that capacitors are stored within the specified range of time, temperature and humidity conditions.	4.5 "Storage conditions"
Flammability	Avoid external energy, such as fire or electricity (passive flammability), avoid overload of the capacitors (active flammability) and consider the flammability of materials.	5.3 "Flammability"
Resistance to vibration	Do not exceed the tested ability to withstand vibration. The capacitors are tested to IEC 60068-2-6:2007. EPCOS offers film capacitors specially designed for operation under more severe vibration regimes such as those found in automotive applications. Consult our catalog "Film Capacitors for Automotive Electronics".	5.2 "Resistance to vibration"

Topic	Safety information	Reference chapter "Mounting guidelines"
Soldering	Do not exceed the specified time or temperature limits during soldering.	1 "Soldering"
Cleaning	Use only suitable solvents for cleaning capacitors.	2 "Cleaning"

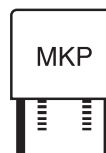

Topic	Safety information	Reference chapter "Mounting guidelines"
Embedding of capacitors in finished assemblies	When embedding finished circuit assemblies in plastic resins, chemical and thermal influences must be taken into account. Caution: Consult us first, if you also wish to embed other uncoated component types!	3 "Embedding of capacitors in finished assemblies"

### Display of ordering codes for EPCOS products

The ordering code for one and the same product can be represented differently in data sheets, data books, other publications and the website of EPCOS, or in order-related documents such as shipping notes, order confirmations and product labels. **The varying representations of the ordering codes are due to different processes employed and do not affect the specifications of the respective products.** Detailed information can be found on the Internet under [www.epcos.com/orderingcodes](http://www.epcos.com/orderingcodes).

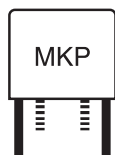

B32774 ... B32778

MKP DC link – high density series up to 480  $\mu\text{F}$

## Symbols and terms

Symbol	English	German
$\alpha$	Heat transfer coefficient	Wärmeübergangszahl
$\alpha_C$	Temperature coefficient of capacitance	Temperaturkoeffizient der Kapazität
A	Capacitor surface area	Kondensatoroberfläche
$\beta_C$	Humidity coefficient of capacitance	Feuchtekoeffizient der Kapazität
C	Capacitance	Kapazität
$C_R$	Rated capacitance	Nennkapazität
$\Delta C$	Absolute capacitance change	Absolute Kapazitätsänderung
$\Delta C/C$	Relative capacitance change (relative deviation of actual value)	Relative Kapazitätsänderung (relative Abweichung vom Ist-Wert)
$\Delta C/C_R$	Capacitance tolerance (relative deviation from rated capacitance)	Kapazitätstoleranz (relative Abweichung vom Nennwert)
dt	Time differential	Differentielle Zeit
$\Delta t$	Time interval	Zeitintervall
$\Delta T$	Absolute temperature change (self-heating)	Absolute Temperaturänderung (Selbsterwärmung)
$\Delta \tan \delta$	Absolute change of dissipation factor	Absolute Änderung des Verlustfaktors
$\Delta V$	Absolute voltage change	Absolute Spannungsänderung
dV/dt	Time differential of voltage function (rate of voltage rise)	Differentielle Spannungsänderung (Spannungsflankensteilheit)
$\Delta V/\Delta t$	Voltage change per time interval	Spannungsänderung pro Zeitintervall
E	Activation energy for diffusion	Aktivierungsenergie zur Diffusion
ESL	Self-inductance	Eigeninduktivität
ESR	Equivalent series resistance	Ersatz-Serienwiderstand
f	Frequency	Frequenz
$f_1$	Frequency limit for reducing permissible AC voltage due to thermal limits	Grenzfrequenz für thermisch bedingte Reduzierung der zulässigen Wechselspannung
$f_2$	Frequency limit for reducing permissible AC voltage due to current limit	Grenzfrequenz für strombedingte Reduzierung der zulässigen Wechselspannung
$f_r$	Resonant frequency	Resonanzfrequenz
$F_D$	Thermal acceleration factor for diffusion	Therm. Beschleunigungsfaktor zur Diffusion
$F_T$	Derating factor	Deratingfaktor
i	Current (peak)	Stromspitze
$I_C$	Category current (max. continuous current)	Kategoriestrom (max. Dauerstrom)

Symbol	English	German
$I_{\text{RMS}}$	(Sinusoidal) alternating current, root-mean-square value	(Sinusförmiger) Wechselstrom
$i_z$	Capacitance drift	Inkonstanz der Kapazität
$k_0$	Pulse characteristic	Impuls Kennwert
$L_s$	Series inductance	Serieninduktivität
$\lambda$	Failure rate	Ausfallrate
$\lambda_0$	Constant failure rate during useful service life	Konstante Ausfallrate in der Nutzungsphase
$\lambda_{\text{test}}$	Failure rate, determined by tests	Experimentell ermittelte Ausfallrate
$P_{\text{diss}}$	Dissipated power	Abgegebene Verlustleistung
$P_{\text{gen}}$	Generated power	Erzeugte Verlustleistung
$Q$	Heat energy	Wärmeenergie
$\rho$	Density of water vapor in air	Dichte von Wasserdampf in Luft
$R$	Universal molar constant for gases	Allg. Molarkonstante für Gas
$R$	Ohmic resistance of discharge circuit	Ohmscher Widerstand des Entladekreises
$R_i$	Internal resistance	Innenwiderstand
$R_{\text{ins}}$	Insulation resistance	Isolationswiderstand
$R_p$	Parallel resistance	Parallelwiderstand
$R_s$	Series resistance	Serienwiderstand
$S$	severity (humidity test)	Schärfegrad (Feuchtetest)
$t$	Time	Zeit
$T$	Temperature	Temperatur
$\tau$	Time constant	Zeitkonstante
$\tan \delta$	Dissipation factor	Verlustfaktor
$\tan \delta_D$	Dielectric component of dissipation factor	Dielektrischer Anteil des Verlustfaktors
$\tan \delta_p$	Parallel component of dissipation factor	Parallelanteil des Verlustfaktors
$\tan \delta_s$	Series component of dissipation factor	Serienanteil des Verlustfaktors
$T_A$	Temperature of the air surrounding the component	Temperatur der Luft, die das Bauteil umgibt
$T_{\text{max}}$	Upper category temperature	Obere Kategorietemperatur
$T_{\text{min}}$	Lower category temperature	Untere Kategorietemperatur
$t_{\text{OL}}$	Operating life at operating temperature and voltage	Betriebszeit bei Betriebstemperatur und -spannung
$T_{\text{op}}$	Operating temperature, $T_A + \Delta T$	Betriebstemperatur, $T_A + \Delta T$
$T_R$	Rated temperature	Nenntemperatur
$T_{\text{ref}}$	Reference temperature	Referenztemperatur
$t_{\text{SL}}$	Reference service life	Referenz-Lebensdauer



**B32774 ... B32778**

**MKP DC link – high density series up to 480  $\mu$ F**

Symbol	English	German
$V_{AC}$	AC voltage	Wechselspannung
$V_C$	Category voltage	Kategorie <span>spannung</span>
$V_{C,RMS}$	Category AC voltage	(Sinusförmige) Kategorie-Wechselspannung
$V_{CD}$	Corona-discharge onset voltage	Teilentlade-Einsatzspannung
$V_{ch}$	Charging voltage	Ladespannung
$V_{DC}$	DC voltage	Gleichspannung
$V_{FB}$	Fly-back capacitor voltage	Spannung (Flyback)
$V_i$	Input voltage	Eingangsspannung
$V_o$	Output voltage	Ausgangsspannung
$V_{op}$	Operating voltage	Betriebsspannung
$V_p$	Peak pulse voltage	Impuls-Spitzen <span>spannung</span>
$V_{pp}$	Peak-to-peak voltage Impedance	Spannungshub
$V_R$	Rated voltage	Nennspannung
$\hat{V}_R$	Amplitude of rated AC voltage	Amplitude der Nenn-Wechselspannung
$V_{RMS}$	(Sinusoidal) alternating voltage, root-mean-square value	(Sinusförmige) Wechselspannung
$V_{SC}$	S-correction voltage	Spannung bei Anwendung "S-correction"
$V_{sn}$	Snubber capacitor voltage	Spannung bei Anwendung "Beschaltung"
$Z$	Impedance	Scheinwiderstand
$e$	Lead spacing	Rastermaß

## Important notes

The following applies to all products named in this publication:

1. Some parts of this publication contain **statements about the suitability of our products for certain areas of application**. These statements are based on our knowledge of typical requirements that are often placed on our products in the areas of application concerned. We nevertheless expressly point out **that such statements cannot be regarded as binding statements about the suitability of our products for a particular customer application**. As a rule, EPCOS is either unfamiliar with individual customer applications or less familiar with them than the customers themselves. For these reasons, it is always ultimately incumbent on the customer to check and decide whether an EPCOS product with the properties described in the product specification is suitable for use in a particular customer application.
2. We also point out that **in individual cases, a malfunction of electronic components or failure before the end of their usual service life cannot be completely ruled out in the current state of the art, even if they are operated as specified**. In customer applications requiring a very high level of operational safety and especially in customer applications in which the malfunction or failure of an electronic component could endanger human life or health (e.g. in accident prevention or lifesaving systems), it must therefore be ensured by means of suitable design of the customer application or other action taken by the customer (e.g. installation of protective circuitry or redundancy) that no injury or damage is sustained by third parties in the event of malfunction or failure of an electronic component.
3. **The warnings, cautions and product-specific notes must be observed.**
4. In order to satisfy certain technical requirements, **some of the products described in this publication may contain substances subject to restrictions in certain jurisdictions (e.g. because they are classed as hazardous)**. Useful information on this will be found in our Material Data Sheets on the Internet ([www.epcos.com/material](http://www.epcos.com/material)). Should you have any more detailed questions, please contact our sales offices.
5. We constantly strive to improve our products. Consequently, **the products described in this publication may change from time to time**. The same is true of the corresponding product specifications. Please check therefore to what extent product descriptions and specifications contained in this publication are still applicable before or when you place an order. We also **reserve the right to discontinue production and delivery of products**. Consequently, we cannot guarantee that all products named in this publication will always be available. The aforementioned does not apply in the case of individual agreements deviating from the foregoing for customer-specific products.
6. Unless otherwise agreed in individual contracts, **all orders are subject to the current version of the "General Terms of Delivery for Products and Services in the Electrical Industry" published by the German Electrical and Electronics Industry Association (ZVEI)**.

## Important notes

7. **Our manufacturing sites serving the automotive business apply the IATF 16949 standard.** The IATF certifications confirm our compliance with requirements regarding the quality management system in the automotive industry. Referring to customer requirements and customer specific requirements (“CSR”) TDK always has and will continue to have the policy of respecting individual agreements. Even if IATF 16949 may appear to support the acceptance of unilateral requirements, we hereby like to emphasize that **only requirements mutually agreed upon can and will be implemented in our Quality Management System.** For clarification purposes we like to point out that obligations from IATF 16949 shall only become legally binding if individually agreed upon.
8. The trade names EPCOS, CeraCharge, CeraDiode, CeraLink, CeraPad, CeraPlas, CSMP, CTVS, DeltaCap, DigiSiMic, ExoCore, FilterCap, FormFit, LeaXield, MiniBlue, MiniCell, MKD, MKK, MotorCap, PCC, PhaseCap, PhaseCube, PhaseMod, PhiCap, PowerHap, PQSine, PQvar, SIFERRIT, SIFI, SIKOREL, SilverCap, SIMDAD, SiMic, SIMID, SineFormer, SIOV, ThermoFuse, WindCap are **trademarks registered or pending** in Europe and in other countries. Further information will be found on the Internet at [www.epcos.com/trademarks](http://www.epcos.com/trademarks).

Release 2018-06



# Mouser Electronics

Authorized Distributor

Click to View Pricing, Inventory, Delivery & Lifecycle Information:

## EPCOS / TDK:

[B32774D4106J000](#) [B32774D4106K000](#) [B32774D4505K000](#) [B32774D8126J000](#) [B32774D8126K000](#)  
[B32774D8305J000](#) [B32774D8305K000](#) [B32774D8505J000](#) [B32776E4306K000](#) [B32776E4356K000](#)  
[B32776E4406K000](#) [B32776E4506K000](#) [B32776E4606K000](#) [B32776E8146K000](#) [B32776E8206J000](#)  
[B32776E8206K000](#) [B32776E8256J000](#) [B32776E8256K000](#) [B32776E8306J000](#) [B32776E8306K000](#)  
[B32776G4306K000](#) [B32776G4356K000](#) [B32776G8156J000](#) [B32776G8206J000](#) [B32776G8206K000](#)  
[B32776G8226J000](#) [B32776G8226K000](#) [B32776G8306J000](#) [B32778G4107K000](#) [B32778G8456J000](#)  
[B32778G8456K000](#) [B32778G8556J000](#) [B32778G8556K000](#) [B32778G8606J000](#) [B32776G1126K000](#)  
[B32776G0206K000](#) [B32774D0505J000](#) [B32778G0406K000](#) [B32774D1305K000](#) [B32776E1106K000](#)  
[B32774D1155K000](#) [B32776E0146K000](#) [B32776G1106K000](#) [B32774D0705K000](#) [B32778G0306K000](#)  
[B32776E1146K000](#) [B32776G0126K000](#) [B32778G1256K000](#) [B32776E0166K000](#) [B32776E0126K000](#)  
[B32776E0206K000](#) [B32774D0705J000](#) [B32776G0166K000](#) [B32778G1206K000](#) [B32776G0146K000](#)  
[B32774D0505K000](#) [B32774D0205J000](#) [B32774D1505K](#) [B32774D4226K](#) [B32774D8505K](#) [B32776G1805K](#)  
[B32776G4406K](#) [B32776G4506K](#) [B32776G8156K](#) [B32776G8306K](#) [B32778G1276K](#) [B32778G4117K](#) [B32778G8606K](#)  
[B32776T0395K](#) [B32776T0505K](#) [B32776T1275K](#) [B32776T1355K](#) [B32776T4126K](#) [B32776T4166K](#) [B32776T5126K](#)  
[B32776T5855K](#) [B32776T8685K](#) [B32776T8855K](#) [B32778G4756K](#) [B32776G106K](#) [B32776G1805J](#) [B32774D205K](#)  
[B32774D4685K000](#) [B32776G1106J](#) [B32778G4806K](#) [B32778G406J](#) [B32776E1146J](#) [B32778G1276J](#) [B32774D1305J](#)  
[B32778G8506K](#) [B32778G306J](#) [B32776G4606K](#) [B32776G126J](#) [B32776G146J](#) [B32778G1406K](#) [B32774D1505J](#)  
[B32778G4756K000](#) [B32776G1805K000](#) [B32778G1276K000](#) [B32778G8606K000](#)