



## Technical Data Sheet

### 5mm Infrared LED, T-1 3/4

#### **HIR323C**

#### Features

- High reliability
- High radiant intensity
- Peak wavelength  $\lambda_p=850\text{nm}$
- 2.54mm Lead spacing
- Low forward voltage
- Pb free

#### Descriptions

- EVERLIGHT'S Infrared Emitting Diode(HIR323C) is a high intensity diode , molded in a water clear plastic package.
- The device is spectrally matched with phototransistor , photodiode and infrared receiver module.



#### Applications

- Free air transmission system
- Optoelectronic switch
- Floppy disk drive
- Infrared applied system
- Smoke detector

#### Device Selection Guide

LED Part No.	Chip	Lens Color
	Material	
HIR	GaAlAs	Water clear

**Package Dimensions**

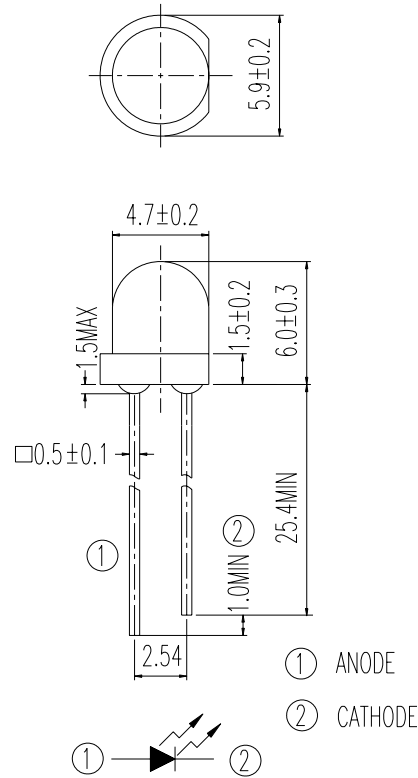

- Notes:** 1.All dimensions are in millimeters  
 2.Tolerances unless dimensions  $\pm 0.25$ mm

**Absolute Maximum Ratings (Ta=25°C)**

Parameter	Symbol	Rating	Units
Continuous Forward Current	$I_F$	100	mA
Peak Forward Current *1	$I_{FP}$	1.0	A
Reverse Voltage	$V_R$	5	V
Operating Temperature	$T_{opr}$	-40 ~ +85	°C
Storage Temperature	$T_{stg}$	-40 ~ +85	°C
Soldering Temperature *2	$T_{sol}$	260	°C
Power Dissipation at(or below) 25°C Free Air Temperature	$P_d$	150	mW

**Notes:** \*1: $I_{FP}$  Conditions--Pulse Width  $\leq 100 \mu s$  and Duty  $\leq 1\%$ .

\*2:Soldering time  $\leq 5$  seconds.

**Electro-Optical Characteristics (Ta=25°C)**

Parameter	Symbol	Condition	Min.	Typ.	Max.	Units
Radiant Intensity	Ee	I <sub>F</sub> =20mA	15	30	--	mW/sr
		I <sub>F</sub> =100mA Pulse Width ≤ 100 μs ,Duty ≤ 1%	--	130	--	
		I <sub>F</sub> =1A Pulse Width ≤ 100 μs ,Duty ≤ 1%.	--	1000	--	
Peak Wavelength	λ <sub>p</sub>	I <sub>F</sub> =20mA	--	850	--	nm
Spectral Bandwidth	Δλ	I <sub>F</sub> =20mA	--	45	--	nm
Forward Voltage	V <sub>F</sub>	I <sub>F</sub> =20mA	--	1.45	1.65	V
		I <sub>F</sub> =100mA Pulse Width ≤ 100 μs ,Duty ≤ 1%	--	1.80	2.40	
		I <sub>F</sub> =1A Pulse Width ≤ 100 μs ,Duty ≤ 1%.	--	4.10	5.25	
Reverse Current	I <sub>R</sub>	V <sub>R</sub> =5V	--	--	10	μA
View Angle	2θ 1/2	I <sub>F</sub> =20mA	--	25	--	deg

**Rank**

 Condition: I<sub>F</sub>=20mA

Unit: mW/sr

Bin number	P	Q	R
Min	15	21	30
Max	24	34	48

**Typical Electro-Optical Characteristics Curves**

Fig.1 Forward Current vs. Ambient Temperature

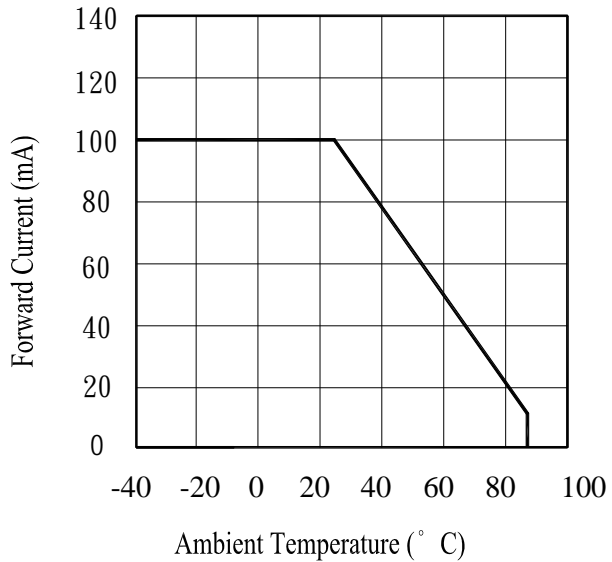

Fig.2 Spectral Distribution

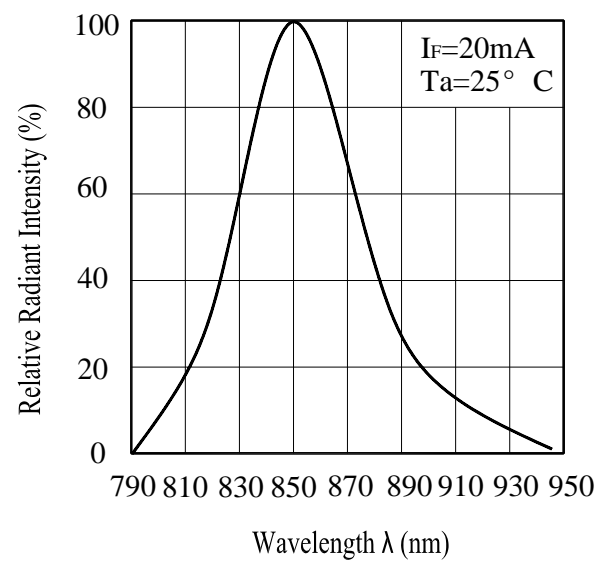

Fig.3 Peak Emission Wavelength vs. Ambient Temperature

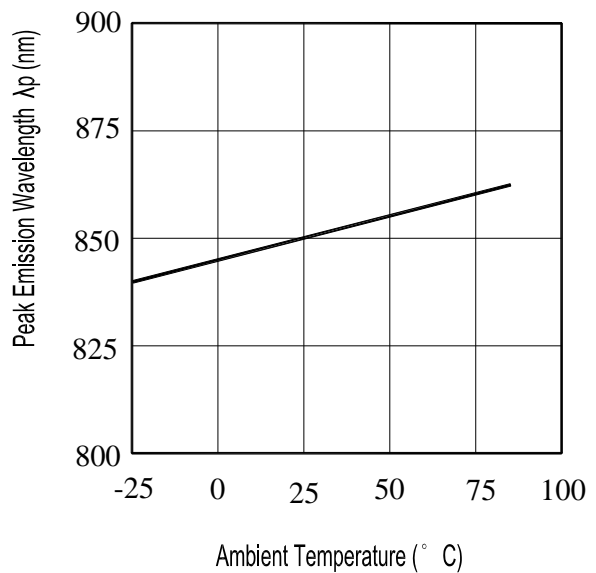
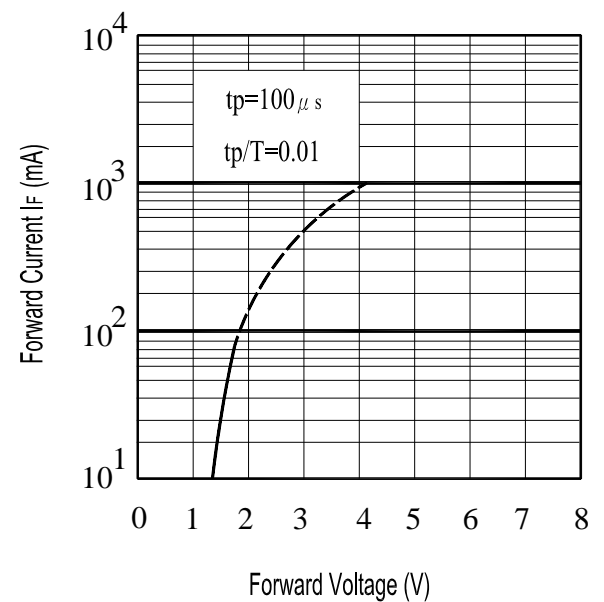

Fig.4 Forward Current vs. Forward Voltage



**Typical Electro-Optical Characteristics Curves**

Fig.5 Relative Intensity vs. Forward Current

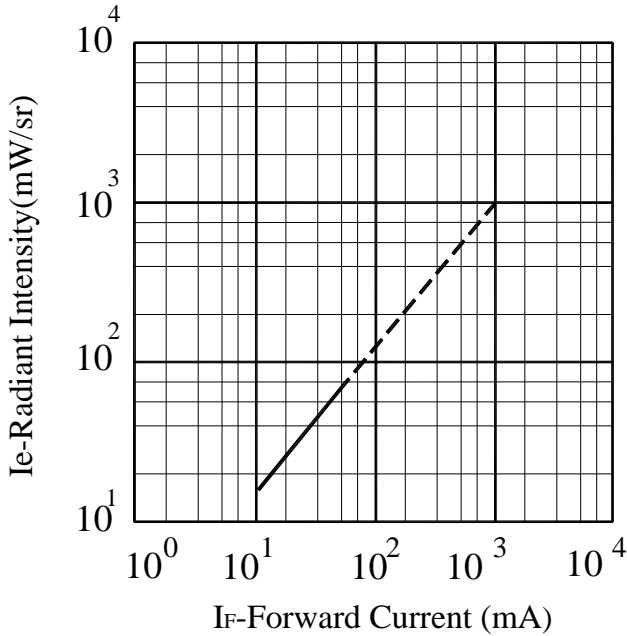

Fig.6 Relative Radiant Intensity vs. Angular Displacement

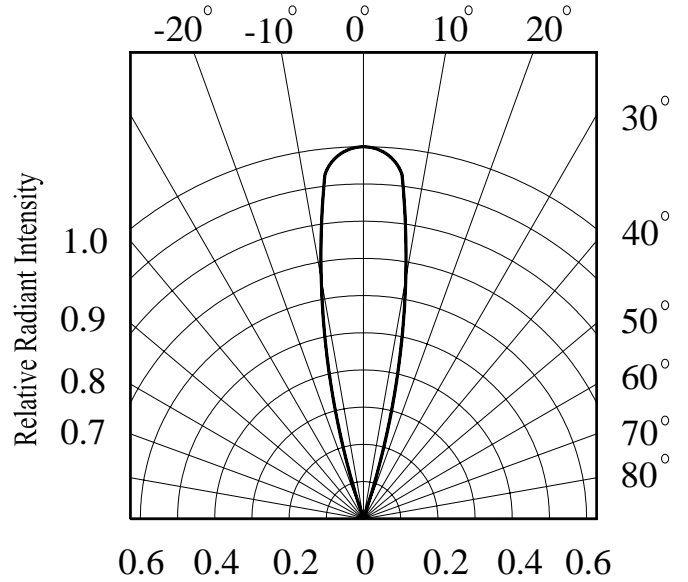

Fig.7 Relative Intensity vs. Ambient Temperature(°C)

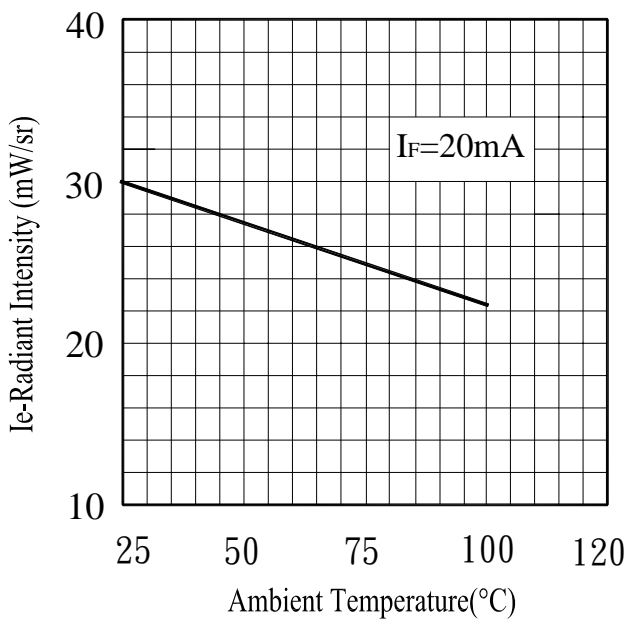
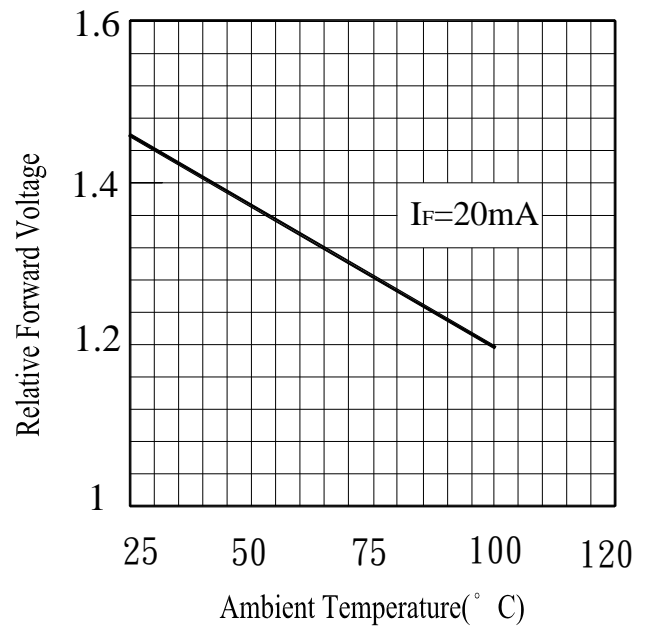

Fig.8 Forward Voltage vs. Ambient Temperature(°C)



**Reliability Test Item And Condition**

The reliability of products shall be satisfied with items listed below.

Confidence level : 90%

LTPD : 10%

NO.	Item	Test Conditions	Test Hours/ Cycles	Sample Sizes	Failure Judgement Criteria	Ac/Re
1	Solder Heat	TEMP. : 260°C±5°C	10secs	22pcs	$I_R \geq U \times 2$ $E_e \leq L \times 0.8$ $V_F \geq U \times 1.2$  U : Upper Specification  Limit L : Lower Specification Limit	0/1
2	Temperature Cycle	H : +100°C    15mins $\updownarrow$ 5mins L : -40°C    15mins	50Cycles	22pcs		0/1
3	Thermal Shock	H : +100°C    5mins $\updownarrow$ 10secs L : -10°C    5mins	50Cycles	22pcs		0/1
4	High Temperature Storage	TEMP. : +100°C	1000hrs	22pcs		0/1
5	Low Temperature Storage	TEMP. : -40°C	1000hrs	22pcs		0/1
6	DC Operating Life	$I_F=20mA$	1000hrs	22pcs		0/1
7	High Temperature/ High Humidity	85°C / 85% R.H	1000hrs	22pcs		0/1

### **Packing Quantity Specification**

- 1.500PCS/1Bag , 5Bags/1Box
- 2.10Boxes/1Carton

### **Label Form Specification**



- CPN: Customer's Production Number
- P/N : Production Number
- QTY: Packing Quantity
- CAT: Ranks
- HUE: Peak Wavelength
- REF: Reference
- LOT No: Lot Number
- MADE IN TAIWAN: Production Place

### **Notes**

1. Above specification may be changed without notice. EVERLIGHT will reserve authority on material change for above specification.
2. When using this product, please observe the absolute maximum ratings and the instructions for using outlined in these specification sheets. EVERLIGHT assumes no responsibility for any damage resulting from use of the product which does not comply with the absolute maximum ratings and the instructions included in these specification sheets.
3. These specification sheets include materials protected under copyright of EVERLIGHT corporation. Please don't reproduce or cause anyone to reproduce them without EVERLIGHT's consent.

<b>EVERLIGHT ELECTRONICS CO., LTD.</b> Office: No 25, Lane 76, Sec 3, Chung Yang Rd, Tucheng, Taipei 236, Taiwan, R.O.C	Tel: 886-2-2267-2000, 2267-9936 Fax: 886-2267-6244, 2267-6189, 2267-6306 <a href="http://www.everlight.com">http://www.everlight.com</a>
---	--

# Mouser Electronics

Authorized Distributor

Click to View Pricing, Inventory, Delivery & Lifecycle Information:

[Everlight:](#)

[HIR323C](#)