

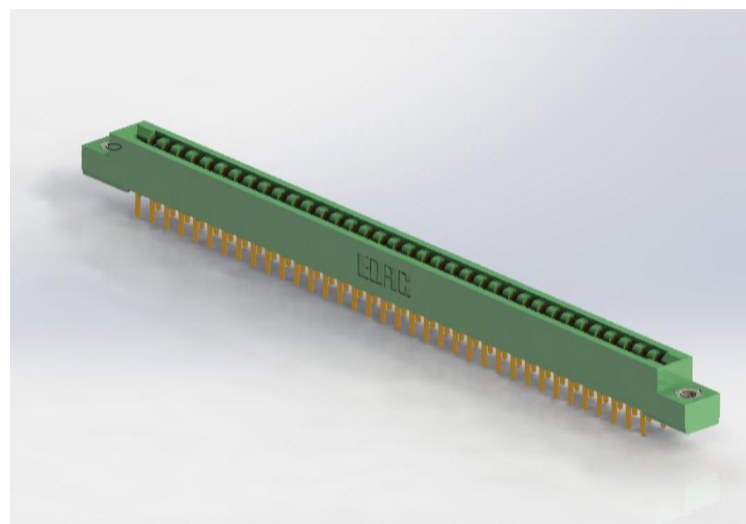

307/357 SERIES



Card Edge Connector 0.156" (3.96mm) Pitch



FEATURES

- 0.156" (3.96mm) Contact Spacing by 0.200" (5.08mm) Row Spacing
- Accepts .062" (1.57mm) Nominal Thickness P.C. Board
- Low Profile Insulator Body, 0.460" (11.68mm)
- Contact Termination Options include P.C. Tail, Wire Hole, Wire Wrap, 90° and Extender Board Bends
- Single or Dual Row Configurations
- Large Variety of Mounting Options
- Accepts between Contact and In-Contact Polarizing Keys
- Pre-assembled Card Guides are available
- RoHS Compliant UL Recognized

Specifications:

Insulator Material	UL 94V-0 Thermoplastic Polyester
Contact Material	Copper Alloy
Contact Plating	Gold Plating on mating area and Tin Plating on tails with Nickel underplating all over
Current Rating	5A Continuous
Contact Resistance	10 milliohms maximum
Withstand Voltage	1800VAC rms at sea level between adjacent contacts
Insulation Resistance	5000 Megohms minimum
Operating Temperature	Operating Temperature: -40°C to +105°C
Insertion Force	16oz (4.45N) maximum per contact pair when tested with .070" (1.78mm) thick gauge
Withdrawal Force	1oz (0.28N) minimum per contact pair when tested with .054" (1.37mm) thick gauge

Example Part Number **307-044-520-202**



Series:	Insulator Color
307	Thermoplastic Polyester, Green
357	Thermoplastic Polyester, Black

Total Number of Contacts:	Contact Rows
006, 007, 044	Single Row
012, 014, 088	Dual Row

Contact Rows:	Description
1	Single Row (Single Readout Flush Mounting Lugs)
2	Dual Row (Dual Readout Flush Mounting Lugs)

Mounting Options:	Description
01	No Mounting Lug
02	Ø.128" (Ø3.25mm) Mounting Holes
03	Ø.116" (Ø2.95mm) I.D. Floating Eyelets
04	Ø.156" (Ø3.96mm) Mounting Holes
07	M3-0.5 Metric Threaded Inserts
08	#4-40 Unified Threaded Inserts
12	Ø.128" (Ø3.25mm) Side Mounting Holes
58	.468" (11.89mm) Offset Card Guides
68	.344" (8.74mm) Offset Card Guides
78	In-Line Card Guides

Contact Code	Description & Tail Size	Tail Length "G"
<i>Single Row Contacts - Read One Side of Daughter Board</i>		
505	Wire Hole .087 x .013 (2.21 x 0.33)	.282 (7.16)
525	P.C. Tail .046 x .013 (1.17 x 0.33)	.213 (5.41)
527	P.C. Tail .046 x .013 (1.17 x 0.33)	.358 (9.09)
531	P.C. Tail .023 x .013 (0.58 x 0.33)	.213 (5.41)
545	Wire Wrap .046 x .013 (1.17 x 0.33)	.708 (17.98)
547	Wire Wrap .046 x .013 (1.17 x 0.33)	.520 (13.21)
558	90 DEGREE BEND (CODE 545 CONTACTS)	
559	90 DEGREE BEND (CODE 527 CONTACTS)	
<i>Single Row Contacts - Read Both Sides of Daughter Board</i>		
501	Wire Hole .089 x .014 (2.29 x 0.36)	.213 (5.41)
521	P.C. Tail .046 x .014 (1.17 x 0.36)	.213 (5.41)
541	Wire Wrap .046 x .014 (1.17 x 0.36)	.495 (12.57)
553	90 DEGREE BEND (CODE 521 CONTACTS)	
554	90 DEGREE BEND (CODE 501 CONTACTS)	
557	90 DEGREE BEND (CODE 541 CONTACTS)	
<i>Dual Row Contacts - Read Both Sides of Daughter Board</i>		
500	Wire Hole .087 x .013 (2.21 x 0.33)	.282 (7.16)
520	P.C. Tail .046 x .013 (1.17 x 0.33)	.213 (5.41)
522	P.C. Tail .046 x .013 (1.17 x 0.33)	.358 (9.09)
524	P.C. Tail .023 x .013 (0.58 x 0.33)	.213 (5.41)
540	Wire Wrap .046 x .013 (1.17 x 0.33)	.708 (17.98)
542	Wire Wrap .046 x .013 (1.17 x 0.33)	.520 (13.21)
555	.062 EXTENDER BOARD BEND (CODE 500 CONTACTS)	
556	.062 EXTENDER BOARD BEND (CODE 520 CONTACTS)	
558	90 DEGREE BEND (CODE 522 AND 540 CONTACTS)	
559	90 DEGREE BEND (CODE 522 AND 540 CONTACTS)	
560	.062 EXTENDER BOARD BEND (CODE 522 CONTACTS)	

Ordering Code Notes:

- 1) All connector sizes up to 44 contacts single row / 88 contacts dual row are available upon request.
- 2) For contacts with overall tin plating, change the first digit of the contact code from 5 to 4
- 3) For details of the extender board and 90 degree bends refer to next pages.
- 4) For details of the mounting options refer to next pages.

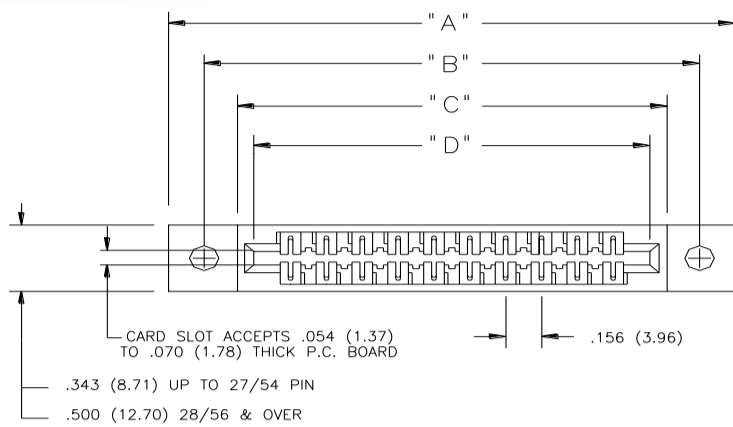

IN-CONTACT POLARIZING KEY
P/N 307-240-328



BETWEEN CONTACT POLARIZING KEY
P/N 306-240-318

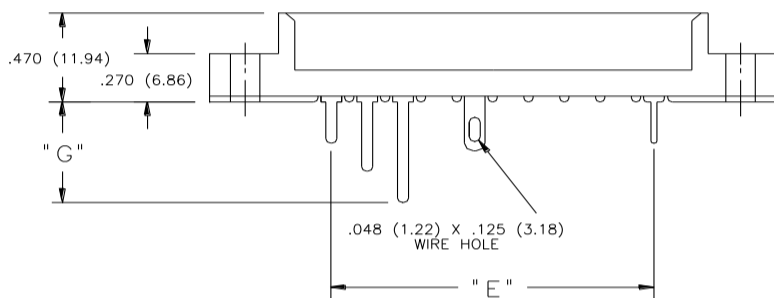
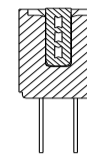

DUAL ROW CONTACTS

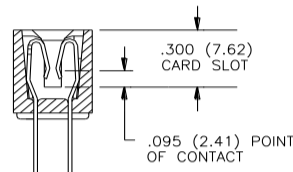

SINGLE ROW CONTACTS
READ ONE SIDE OF DAUGHTER BOARD

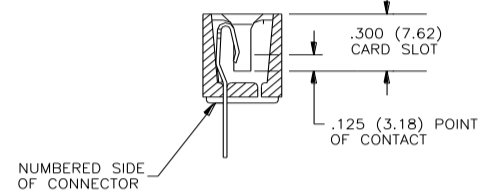

SINGLE ROW CONTACTS
READ BOTH SIDES OF DAUGHTER BOARD

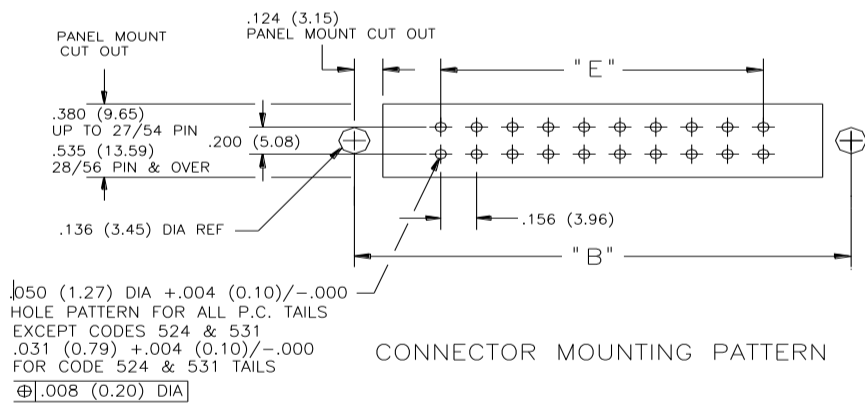
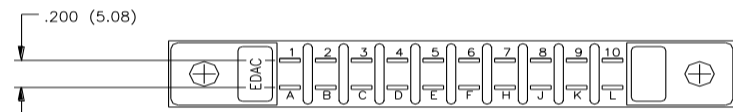
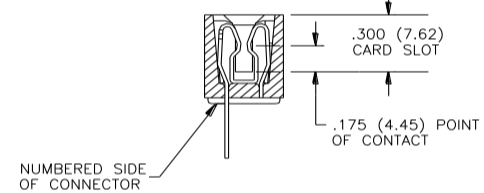

CONNECTOR MOUNTING PATTERN

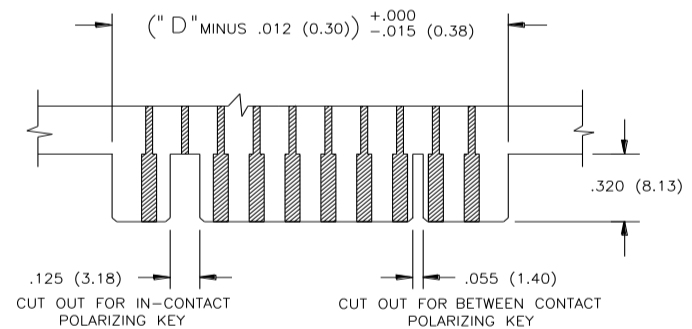

RECOMMENDED DAUGHTER BOARD

NUMBER OF CONTACTS		"A"		"B"		"C"		"D"		"E"	
Single	Double	Inch	mm	Inch	mm	Inch	mm	Inch	mm	Inch	mm
6	12	1.842	46.79	1.532	38.91	1.246	31.65	1.100	27.94	0.780	19.81
8	16	2.154	54.71	1.844	46.84	1.558	39.57	1.412	35.86	1.092	27.74
10	20	2.466	62.64	2.156	54.76	1.870	47.50	1.724	43.79	1.404	35.66
12	24	2.778	70.56	2.468	62.69	2.182	55.42	2.036	51.71	1.716	43.59
15	30	3.246	82.45	2.936	74.57	2.650	67.31	2.504	63.60	2.184	55.47
18	36	3.714	94.34	3.404	86.46	3.118	79.20	2.972	75.49	2.652	67.36
20	40	4.026	102.26	3.716	94.39	3.430	87.12	3.284	83.41	2.964	75.29
22	44	4.338	110.19	4.028	102.31	3.742	95.05	3.596	91.34	3.276	83.21
25	50	4.806	122.07	4.496	114.20	4.210	106.93	4.064	103.23	3.744	95.10
28	56	5.274	133.96	4.964	126.09	4.678	118.82	4.532	115.11	4.212	106.98
30	60	5.586	141.88	5.276	134.01	4.990	126.75	4.844	123.04	4.524	114.91
36	72	6.522	165.66	6.212	157.78	5.926	150.52	5.780	146.81	5.460	138.68
43	86	7.614	193.40	7.304	185.52	7.018	178.26	6.872	174.55	6.552	166.42
44	88	7.770	197.36	7.460	189.48	7.174	182.22	7.028	178.51	6.708	170.38

CONTACT
CODE 500

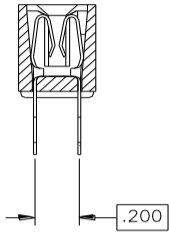

CONTACT
CODE 520

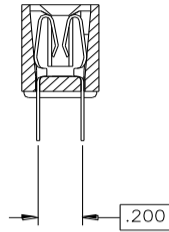

CONTACT
CODE 555

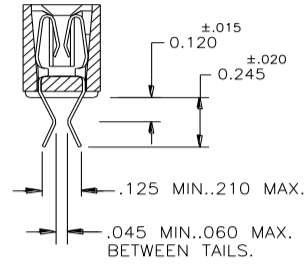

CONTACT
CODE 556

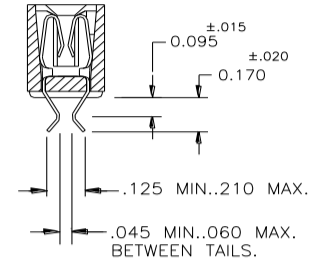

CONTACT
CODE 558

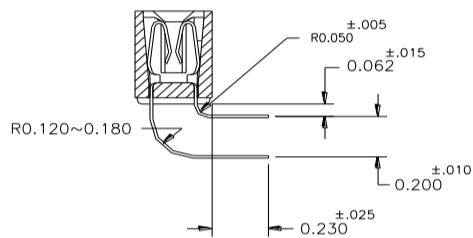

CONTACT
CODE 559

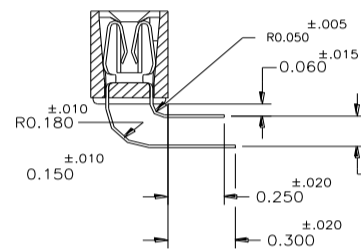

VARIATION 01
NO MOUNTING LUG

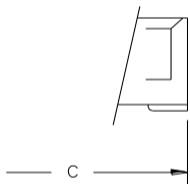

VARIATION 02
.128 ±.003 DIA. MOUNTING HOLE

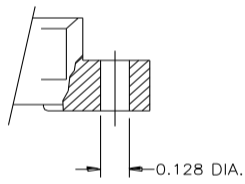

VARIATION 03
.116 ±.003 I.D. FLOATING EYELET

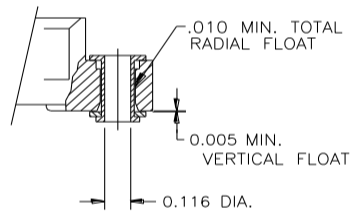

VARIATION 04
.156 ±.002 DIA. MOUNTING HOLE

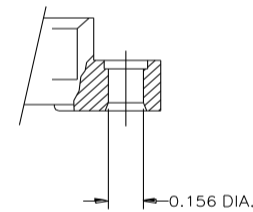

VARIATIONS 07 AND 08
THREADED INSERT

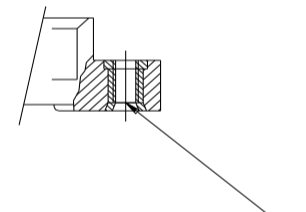

M3-0.5 THREADED INSERT OR
4-40 UNC THREADED INSERT

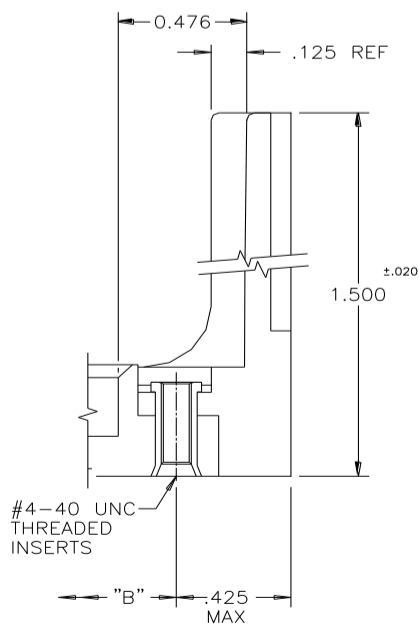

MOUNTING OPTION
CODE #58

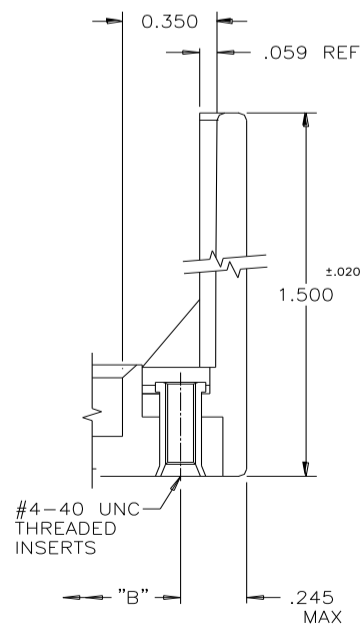

MOUNTING OPTION
CODE #68

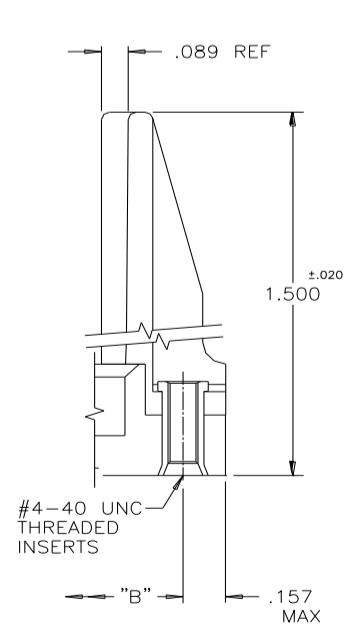

MOUNTING OPTION
CODE #78

Mouser Electronics

Authorized Distributor

Click to View Pricing, Inventory, Delivery & Lifecycle Information:

EDAC:

[307-022-505-101](#) [307-022-505-102](#) [307-022-505-104](#) [307-022-506-101](#) [307-022-506-102](#) [307-022-506-104](#) [307-022-521-101](#) [307-022-521-102](#) [307-022-521-104](#) [307-022-525-101](#) [307-022-525-102](#) [307-022-525-104](#) [307-022-531-101](#) [307-022-531-102](#) [307-022-531-104](#) [307-022-532-101](#) [307-022-532-102](#) [307-022-532-104](#) [307-022-541-101](#) [307-022-541-102](#) [307-022-541-104](#) [307-022-545-101](#) [307-022-545-102](#) [307-022-545-104](#) [307-024-500-201](#) [307-024-500-204](#) [307-024-502-201](#) [307-024-502-202](#) [307-024-502-204](#) [307-024-520-201](#) [307-024-520-202](#) [307-024-520-204](#) [307-024-522-201](#) [307-024-522-202](#) [307-024-522-204](#) [307-024-524-201](#) [307-024-524-202](#) [307-024-524-204](#) [307-024-526-201](#) [307-024-526-202](#) [307-024-526-204](#) [307-024-528-201](#) [307-024-528-202](#) [307-024-528-204](#) [307-024-533-201](#) [307-024-533-202](#) [307-024-533-204](#) [307-024-540-201](#) [307-024-540-202](#) [307-024-540-204](#) [307-024-542-201](#) [307-024-542-202](#) [307-024-542-204](#) [307-024-544-201](#) [307-024-544-202](#) [307-024-544-204](#) [307-025-501-101](#) [307-025-501-102](#) [307-025-501-104](#) [307-025-505-101](#) [307-025-505-102](#) [307-025-505-104](#) [307-025-506-101](#) [307-025-506-102](#) [307-025-506-104](#) [307-025-521-101](#) [307-025-521-102](#) [307-025-521-104](#) [307-025-525-101](#) [307-025-525-102](#) [307-025-525-104](#) [307-025-531-101](#) [307-025-531-102](#) [307-025-531-104](#) [307-025-532-101](#) [307-025-532-102](#) [307-025-532-104](#) [307-025-541-101](#) [307-025-541-102](#) [307-025-541-104](#) [307-025-545-101](#) [307-025-545-102](#) [307-025-545-104](#) [307-028-501-101](#) [307-028-501-102](#) [307-028-501-104](#) [307-028-505-101](#) [307-028-505-102](#) [307-028-505-104](#) [307-028-506-101](#) [307-028-506-102](#) [307-028-506-104](#) [307-028-521-101](#) [307-028-521-102](#) [307-028-521-104](#) [307-028-525-101](#) [307-028-525-102](#) [307-028-525-104](#) [307-028-531-101](#) [307-028-531-102](#)