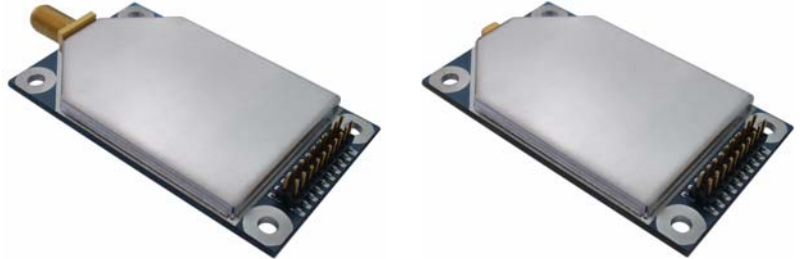


# 9XTend™ OEM RF Module

---

9XTend OEM RF Module  
RF Module Operation  
RF Module Configuration  
RF Communication Modes  
Appendices



## Product Manual [v2.x4x](#)

For OEM RF Module Part Numbers that begin with: XT09-R..., XT09-M...

**1 Watt Transmit Power, 256-bit AES Encryption**



**MaxStream®**

355 South 520 West, Suite 180

Lindon, UT 84042

Phone: (801) 765-9885

Fax: (801) 765-9895

[rf-xperts@maxstream.net](mailto:rf-xperts@maxstream.net)

[www.MaxStream.net](http://www.MaxStream.net) (live chat support)

M100115

2007.01.04

**© 2007 MaxStream, Inc. All rights reserved**

The contents of this manual may not be transmitted or reproduced in any form or by any means without the written permission of MaxStream, Inc.

XTend™ is a trademark of MaxStream, Inc.

**AES Encryption Source Code**

© 2007 Dr. Brian Gladman, Worcester, UK. All rights reserved.

Conditions:

- Distributions of AES source code include the above copyright notice, this list of conditions and disclaimer.
- Distributions in binary form include the above copyright notice, this list of conditions and disclaimer in the documentation and/or other associated materials.
- The copyright holder's name is not used to endorse products built using this software without specific written permission.

Alternatively, provided that this notice is retained in full, this product may be distributed under the terms of the GNU General Public License (GPL), in which case the provisions of the GPL apply INSTEAD OF those given above.

Disclaimer - This AES software is provided 'as is' with no explicit or implied warranties in respect of its properties, including, but not limited to, correctness and/or fitness for purpose.

**Technical Support:** Phone: (801) 765-9885  
E-mail: rf-xperts@maxstream.net  
Live Chat: www.maxstream.net

# Contents

<b>1. 9XTend OEM RF Module</b>	<b>4</b>	<b>Appendix A: Agency Certifications</b>	<b>54</b>
<b>1.1. Key Features</b>	<b>4</b>	<b>FCC (United States) Certification</b>	<b>54</b>
1.1.1. Worldwide Acceptance	4	OEM Labeling Requirements	54
<b>1.2. Specifications</b>	<b>5</b>	FCC Notices	54
<b>1.3. Pin Signals</b>	<b>6</b>	Limited Modular Approval	55
<b>1.4. Electrical Characteristic</b>	<b>7</b>	FCC-approved Antennas	55
1.4.1. Timing Specifications	7	<b>IC (Industry Canada) Certification</b>	<b>58</b>
<b>1.5. Mechanical Drawings</b>	<b>8</b>	Labeling Requirements	58
<b>2. RF Module Operation</b>	<b>9</b>	<b>C-TICK (Australia) Certification</b>	<b>58</b>
<b>2.1. Serial Communications</b>	<b>9</b>	Power Requirements	58
2.1.1. UART Data Flow	9	<b>Appendix B: Development Guide</b>	<b>59</b>
2.1.2. Flow Control	10	<b>Development Kit Contents</b>	<b>59</b>
2.1.3. Transparent Operation	11	Interfacing Hardware	59
2.1.4. API Operation	11	<b>XTIB-R RS-232/485 Interface Board</b>	<b>60</b>
<b>2.2. Modes of Operation</b>	<b>12</b>	Automatic DIP Switch Configurations	61
2.2.1. Idle Mode	12	Adapters	62
2.2.2. Transmit Mode	12	<b>Interfacing Protocols</b>	<b>64</b>
2.2.3. Receive Mode	14	RS-232 Operation	64
2.2.4. Shutdown Mode	14	RS-485 (2-wire) Operation	66
2.2.5. Sleep Mode	15	RS-485 (4-wire) & RS-422 Operation	67
2.2.6. Command Mode	17	<b>X-CTU Software</b>	<b>69</b>
<b>3. RF Module Configuration</b>	<b>19</b>	Installation	69
<b>3.1. Programming Examples</b>	<b>19</b>	Serial Communications Software	69
3.1.1. AT Commands	19	<b>Appendix C: Additional Information</b>	<b>70</b>
3.1.2. Binary Commands	19	<b>1-Year Warranty</b>	<b>70</b>
<b>3.2. Command Reference Table</b>	<b>20</b>	<b>Ordering Information</b>	<b>70</b>
<b>3.3. Command Descriptions</b>	<b>22</b>	<b>Contact MaxStream</b>	<b>71</b>
<b>3.4. API Operation</b>	<b>40</b>		
3.4.1. API Frame Specifications	40		
3.4.2. API Types	41		
<b>4. RF Communication Modes</b>	<b>43</b>		
<b>4.1. Addressing</b>	<b>44</b>		
4.1.1. Address Recognition	44		
<b>4.2. Basic Communications</b>	<b>45</b>		
4.2.1. Streaming Mode (Default)	45		
4.2.2. Multi-transmit Mode	46		
4.2.3. Repeater Mode	47		
4.2.4. Polling Mode (Basic)	50		
<b>4.3. Acknowledged Communications</b>	<b>51</b>		
4.3.1. Acknowledged Mode	51		
4.3.2. Polling Mode (Acknowledged)	53		

# 1. 9XTend OEM RF Module

The 9XTend OEM RF Module was engineered to provide OEMs an easy-to-use RF solution that provides reliable delivery of critical data between remote devices. The module transfers a standard asynchronous serial data stream, operates within the ISM 900 MHz frequency band and sustains up to 115.2 Kbps data throughput.



## 1.1. Key Features

### Long Range Data Integrity

- 1 Watt Power Output** (variable 1mW - 1W)  
Range (@9,600 bps throughput data rate):
- Indoor/Urban: **up to 3000'** (900 m)
  - Outdoor RF line-of-sight: **up to 14 miles** (22 km) w/dipole antenna
  - Outdoor RF line-of-sight: **up to 40 miles** (64 km) w/high-gain antenna
- Range (@115,200 bps throughput data rate):
- Indoor/Urban: **up to 1500'** (450 m)
  - Outdoor RF line-of-sight: **up to 7 miles** (11 km) w/dipole antenna
  - Outdoor RF line-of-sight: **up to 20 miles** (32 km) w/high-gain antenna
- Continuous RF data stream up to **115,200 bps**  
Receiver Sensitivity: **-110 dBm** (@ 9600 baud),  
**-100 dBm** (@ 115200 baud)

### Advanced Networking & Security

- True Peer-to-Peer (no Master device required),  
Point-to-Point, Point-to-Multipoint & Multidrop  
Retries and Acknowledgements  
FHSS (Frequency Hopping Spread Spectrum)  
10 hopping channels, each with over 65,000  
unique network addresses available  
**256-bit AES Encryption**  
(AES algorithm is FIPS-197 certified)

### Low Power

- 2.8 - 5.5 V Supply Voltage  
Pin, Serial Port and Cyclic  
software sleep modes supported  
Shutdown pin enables hardware sleep mode  
that draws only 5  $\mu$ A (typical)

### Easy-to-Use

- No configuration necessary for out-of box  
RF communications  
Free X-CTU Software  
(Testing and configuration software)  
RF Modules easily configured using  
standard AT & binary commands  
Transparent Operation  
(Wireless links replace serial wires)  
API Operation  
(Frame-based communications)  
Portable  
(small form-factor easily designed into  
a wide range of data systems)  
Software-selectable I/O interfacing rates  
Multiple data formats supported  
(parity, start and stop bits, etc.)  
XII™ Interference Immunity  
No Master/Slave setup dependencies  
**Free & Unlimited Technical Support**

### 1.1.1. Worldwide Acceptance

**FCC Approved** (USA) Refer to Appendix A [p54] for FCC Requirements.  
Systems that include XTend RF Modules inherit MaxStream's Certifications.

**ISM** (Industrial, Scientific & Medical) license-free 902-928 MHz frequency band

Manufactured under **ISO 9001:2000** registered standards

**ESD (Electrostatic Discharge) immunity** - ESD-hardened and IEC1000-4-2 (Level 4) tested  
9XTend OEM RF Modules are optimized for use in the **US, Canada, Australia and Israel**  
(contact MaxStream for complete list of agency approvals).



## 1.2. Specifications

**Table 1-01. 9XTend-PKG-R OEM RF Module**

<b>9XTend 900 MHz OEM RF Module Specifications</b>		
<b>Performance</b>	<b>@9600 bps Throughput Data Rate</b>	<b>@115200 bps Throughput Data Rate</b>
Transmit Power Output (software selectable using PL command)	1mW - 1 Watt	1mW - 1 Watt
Indoor/Urban Range	Up to 3000' (900 m)	Up to 1500' (450 m)
Outdoor RF line-of-sight Range	Up to 14 miles (22 km) w/ dipole antenna Up to 40 miles (64 km) w/ high-gain antenna	Up to 7 miles (11 km) w/ dipole antenna Up to 20 miles (32 km) w/ high-gain antenna
Interface Data Rate (software selectable using BD command)	1200 – 230400 bps	1200 – 230400 bps
Throughput Data Rate (software selectable using BR command)	9,600 bps	115,200 bps
RF Data Rate	10,000 bps	125,000 bps
Receiver Sensitivity	-110 dBm	-100 dBm
<b>Power Requirements</b>		
Receive Current	80 mA	
Shutdown Mode Power Down	5 µA typical	
Pin Sleep Power Down	147 µA	
Idle Currents	16 sec cyclic sleep (SM=8)	0.3 - 0.8 mA
	8 sec cyclic sleep (SM=7)	0.4 - 1.4 mA
	4 sec cyclic sleep (SM=6)	0.6 - 2.6 mA
	2 sec cyclic sleep (SM=5)	0.9 - 4.8 mA
	1 sec cyclic sleep (SM=4)	1.6 - 8.7 mA
<b>Networking &amp; Security</b>		
Frequency	902-928 MHz	
Spread Spectrum	FHSS (Frequency Hopping Spread Spectrum)	
Modulation	FSK (Frequency Shift Keying)	
Supported Network Topologies	Peer-to-Peer ("Master/Slave" relationship not required), Point-to-Point, Point-to-Multipoint	
Channel Capacity	10 hop sequences share 50 frequencies	
Encryption	256-bit AES Encryption – Refer to the KY Command [p29] to implement	
<b>Physical Properties</b>		
RF Module Board Size	1.44" x 2.38" x 0.20" (3.65 cm x 6.05 cm x 0.51 cm)	
Weight	0.64 oz. (18 g)	
Connector	20-pin	
Operating Temperature	-40 to 85° C (industrial)	
<b>Antenna</b>		
Connector Options	RPSMA (Reverse-polarity SMA) or MMCX	
Impedance	50 ohms unbalanced	
<b>Certifications (partial list)</b>		
FCC Part 15.247	OUR-9XTEND	
Industry Canada (IC)	4214A-9XTEND	

**Table 1-02. XTend OEM RF Module Specifications - Relative to user-selected TX Power Output**

<b>Power Requirements (Supply voltage and TX currents relative to each TX Power Output option)</b>					
<b>Transmit Power Output</b>	<b>1 mW</b>	<b>10 mW</b>	<b>100 mW</b>	<b>500 mW *</b>	<b>1 W *</b>
Supply Voltage	2.8 - 5.5 VDC			3.0 - 5.5 VDC	4.75 - 5.5 VDC
Transmit Current (5 V) typical	110 mA	140 mA	270 mA	500 mA	730 mA
Transmit Current (3.3 V) typical	90 mA	110 mA	260 mA	600 mA	**

\* If the supply voltage for a given power setting is lower than the minimum supply voltage requirement (as shown in Table 1-02), the TX Power Output will decrease to the highest power level setting given the current supply voltage.

\*\* 1W Power Output is not supported when using a 3.3 supply voltage.

## 1.3. Pin Signals

Figure 1-01. XTend OEM RF Module Pin Numbers

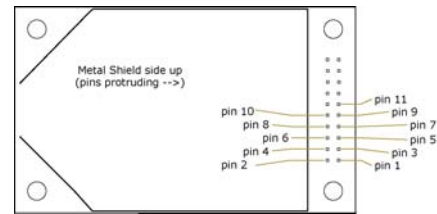


Table 1-03. Pin Signal Descriptions

(Low-asserted signals distinguished with a horizontal line over signal name.)

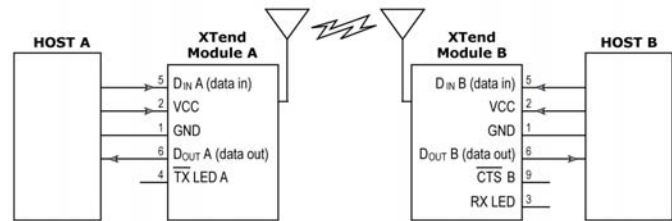
Pin Number	Mnemonic	I/O	High Impedance during Shutdown	Must Connect	Function
1	GND	-	-	yes	Ground
2	VCC	I	-	yes	Power: 2.8 - 5.5 VDC
3	GPO2 / RX LED	O	yes	-	<b>General Purpose Output 2:</b> <Default (CD=2)> Pin is driven low. Refer to the CD Command [p24] for other configuration options. <b>RX LED:</b> Pin is driven high during RF data reception; otherwise, the pin is driven low. Refer to the CD Command [p24] to enable.
4	$\overline{\text{TX\_PWR}}$	O	yes	-	<b>Transmit Power:</b> Pin pulses low during RF transmission; otherwise, the pin is driven high to indicate power is on and the module is not in Sleep or Shutdown Mode.
5	DI	I	yes	yes	<b>Data In:</b> Serial data entering the module (from the UART host). Refer to the Serial Communications [p9] section for more information.
6	DO	O	yes	-	<b>Data Out:</b> Serial Data exiting the module (to the UART host). Refer to the Serial Communications [p9] section for more information.
7	$\overline{\text{SHDN}}$	I	no	yes	<b>Shutdown:</b> Pin is driven high during operation and low during Shutdown. Shutdown enables the lowest power mode ( $-5 \mu\text{A}$ ) available to the module. Refer to the Shutdown Mode [p14] section for more information.
8	GPI2 / SLEEP	I	yes	-	<b>General Purpose Input 2:</b> reserved for future use <b>SLEEP:</b> By default, SLEEP is not used. To configure this pin to enable Sleep Modes, refer to the Sleep Mode [p15], SM Command [p37] & PW Command [p32] sections.
9	GPO1 / $\overline{\text{CTS}}$ / RS-485 TX_EN	O	yes	-	<b>General Purpose Output 1:</b> reserved for future use <b>CTS (Clear-to-Send):</b> <Default (CS=0)> When pin is driven low, the UART host is permitted to send serial data to the module. Refer to the Serial Communications [p9] & CS Command [p25] sections for more information. <b>RS-485 Transmit Enable:</b> To configure this pin to enable RS-485 half and full-duplex communications. Refer to the Serial Communications [p9] & CS Command [p25] sections.
10	GPI1 / $\overline{\text{RTS}}$ / CMD	I	yes	-	<b>General Purpose Input 1:</b> reserved for future use <b>RTS (Request-to-Send):</b> By default, is not used. To configure this pin to regulate the flow of serial data exiting the module, refer to the Serial Communications [p9] & RT Command [p36] sections. <b>CMD (Command):</b> By default, CMD is not used. To configure this pin to enable binary command programming, refer to the Binary Commands [p18] & RT Command [p36] sections.
11	$\overline{\text{CONFIG}}$ / RSSI	I* O*	no no	- -	<b>Configuration:</b> Pin can be used as a backup method for entering Command Mode during power-up. Refer to the Command Mode [p17] section for more information. <b>Receive Signal Strength Indicator:</b> By default, pin is used as an RSSI PWM output after at the conclusion of the power-up sequence. Refer to the RP Command [p35] for more information.
12-20					reserved / do not connect

\* RF module has 10K  $\Omega$  internal pull-up resistor

Note: When integrating the module with a Host PC board, all lines not used should be left disconnected (floating).

## 1.4. Electrical Characteristic

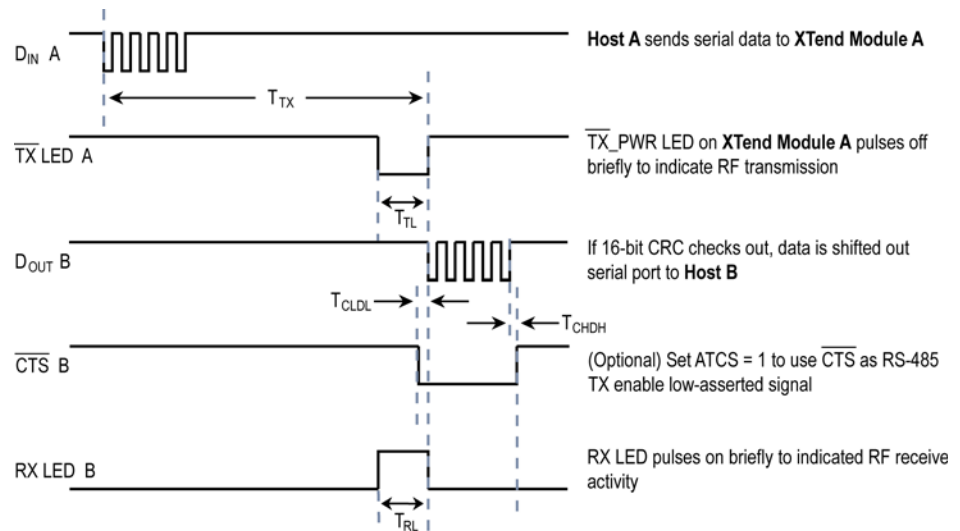
**Figure 1-02. System Block Diagram**  
Basic RF Link between Hosts



The data flow sequence is initiated when the first byte of data is received in the DI Buffer of the transmitting module (XTend RF Module A). As long as XTend RF Module A is not already receiving RF data, data in the DI Buffer is packetized then transmitted over-the-air to XTend RF Module B.

### 1.4.1. Timing Specifications

**Figure 1-03. Timing Specifications** ('A' and 'B' refer to Figure 1-02)



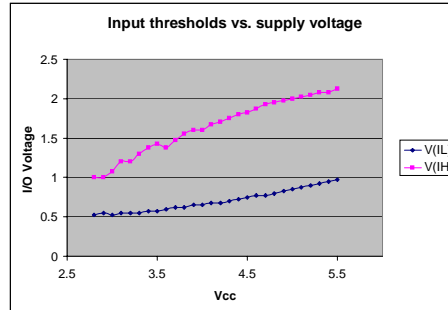
**Table 1-04. AC Characteristics** (Symbols correspond with Figure 1-02 and Figure 1-03, ATSY Parameter = 0)

Symbol	Description	Sleep Mode	115200 Baud Rate	9600 Baud Rate
T <sub>TX</sub>	Latency from the time data is transmitted until it is received.	SM = 0 (No sleep)	9.4 msec	94 msec
		SM = 8	16 sec	16 sec
		SM = 7	8 sec	8 sec
		SM = 6	4 sec	4 sec
		SM = 5	2 sec	2 sec
T <sub>TL</sub>	Time that TX_PWR pin (pin 4) is driven low	--	2.45 msec	29.6 msec
T <sub>RL</sub>	Time that RX LED (pin 3) is driven high	--	2.26 msec	27.2 msec
T <sub>CLDL</sub>	Time starting when CTS goes low until the first bit appears on DOUT	--	44 μsec	75 μsec
T <sub>CHDH</sub>	Time after last bit of data until CTS goes high	--	7 μsec	7 μsec

**Table 1-05. DC Characteristics (V<sub>CC</sub> = 2.8 - 5.5 VDC)**

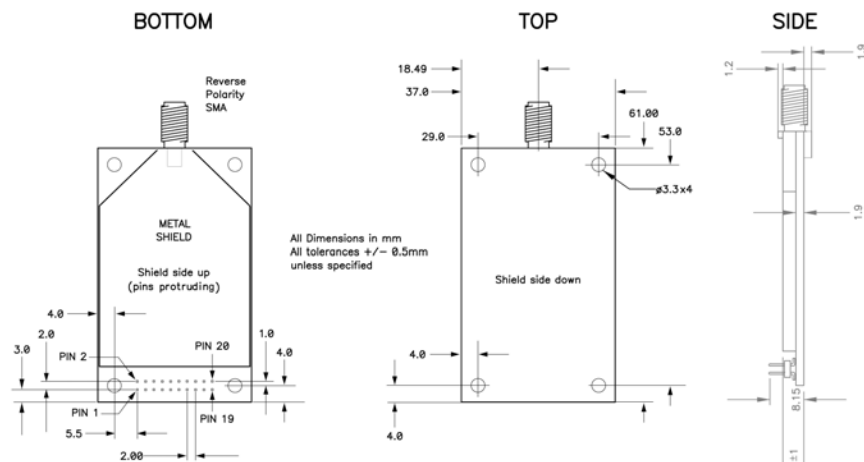
Symbol	Parameter	Condition
V <sub>OL</sub>	Output Low Voltage	V <sub>OL</sub> = 0.33V (I <sub>O</sub> = 6 mA)
V <sub>OH</sub>	Output High Voltage	V <sub>OH</sub> = V <sub>SUPPLY</sub> - 0.7V (-I <sub>O</sub> = 6 mA)

**Figure 1-04. Input Thresholds vs. Supply Voltage**

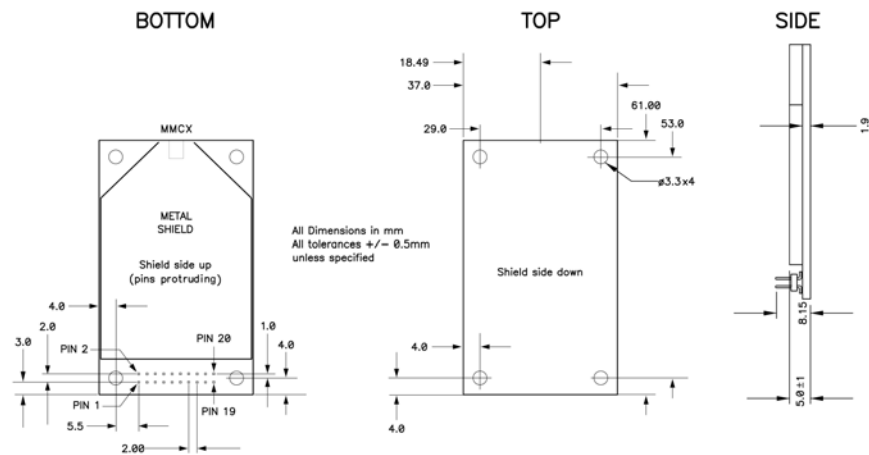


## 1.5. Mechanical Drawings

**Figure 1-05. Mechanical drawings of the XTend OEM RF Module (w/RPSMA Connector)**



**Figure 1-06. Mechanical drawings of the XTend OEM RF Module (w/MMCX Connector)**





# 2. RF Module Operation



**WARNING:** When operating at 1 Watt power output, observe a minimum separation distance of 2' (0.6m) between modules. Transmitting in close proximity of other modules can damage module front ends.

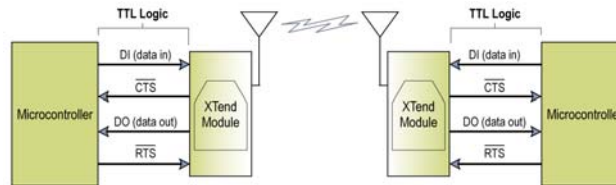
## 2.1. Serial Communications

The XTend OEM RF Modules interface to a host device through a TTL-level asynchronous serial port. Through its serial port, the module can communicate with any UART voltage compatible device or through a level translator to any serial device (For example: RS-232/485/422 or USB interface board).

### 2.1.1. UART Data Flow

Devices that have a UART interface can connect directly to the pins of the RF module as shown in the figure below.

**Figure 2-01. System Data Flow Diagram in a UART-interfaced environment**  
(Low-asserted signals distinguished with horizontal line over signal name.)

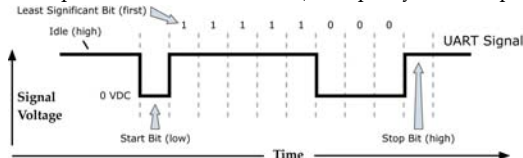


### Serial Data

Data enters the module UART through the pin 5 as an asynchronous serial signal. The signal should idle high when no data is being transmitted.

Each data byte consists of a start bit (low), 8 data bits (least significant bit first) and a stop bit (high). The following figure illustrates the serial bit pattern of data passing through the module.

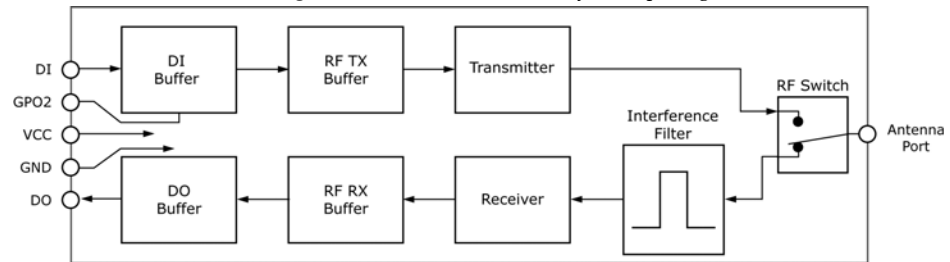
**Figure 2-02. UART data packet 0x1F (decimal number "31") as transmitted through the RF module**  
Example Data Format is 8-N-1 (bits - parity - # of stop bits)



The module UART performs tasks, such as timing and parity checking, that are needed for data communications. Serial communications depend on the two UARTs to be configured with compatible settings (baud rate, parity, start bits, stop bits, data bits).

## 2.1.2. Flow Control

**Figure 2-03. Internal Data Flow Diagram** (The five most commonly-used pin signals shown)



### DI (Data In) Buffer and Flow Control

When serial data enters the module through the DI pin (pin 5), the data is stored in the DI Buffer until it can be processed.

When the RB and RO parameter thresholds are satisfied (refer to 'Transmit Mode' section for more information), the module attempts to initialize an RF connection. If the module is already receiving RF data, the serial data is stored in the module's DI Buffer. The DI buffer stores at least 2.1 KB. If the DI buffer becomes full, hardware or software flow control must be implemented in order to prevent overflow (loss of data between the host and RF module).

#### How to eliminate the need for flow control:

1. Send messages that are smaller than the DI buffer size. The size of the DI buffer varies according to the packet size (PK parameter) and the parity setting (NB parameter) used.
2. Interface at a lower baud rate (BD parameter) than the RF data rate (BR parameter).

#### Two cases in which the DI Buffer may become full and possibly overflow:

1. If the serial interface data rate is set higher than the RF data rate of the module, the module will receive data from the host faster than it can transmit the data over-the-air.
2. If the module is receiving a continuous stream of RF data or if the module is monitoring data on a network, any serial data that arrives on the DI pin (pin 5) is placed in the DI Buffer. The data in the DI buffer will be transmitted over-the-air when the module no longer detects RF data in the network.

**Hardware Flow Control ( $\overline{\text{CTS}}$ ).** When the DI buffer is 17 bytes away from being full; by default, the module de-asserts  $\overline{\text{CTS}}$  (high) to signal to the host device to stop sending data [refer to FT (Flow Control Threshold) and CS (GPO1 Configuration) Commands].  $\overline{\text{CTS}}$  is re-asserted after the DI Buffer has 34 bytes of memory available.

**Software Flow Control (XON).** XON/XOFF software flow control can be enabled using the FL (Software Flow Control) Command. This option only works with ASCII data.

### DO (Data Out) Buffer

When RF data is received, the data enters the DO buffer and is sent out the serial port to a host device. Once the DO Buffer reaches capacity, any additional incoming RF data is lost. The DO buffer stores at least 2.1 KB.

#### Two cases in which the DO Buffer may become full and possibly overflow:

1. If the RF data rate is set higher than the interface data rate of the module, the module will receive data from the transmitting module faster than it can send the data to the host.
2. If the host does not allow the module to transmit data out from the DO buffer because of being held off by hardware or software flow control.

**Hardware Flow Control ( $\overline{\text{RTS}}$ ).** If  $\overline{\text{RTS}}$  is enabled for flow control (RT Parameter = 2), data will not be sent out the DO Buffer as long as  $\overline{\text{RTS}}$  (pin 10) is de-asserted.

**Software Flow Control (XOFF).** XON/XOFF software flow control can be enabled using the FL (Software Flow Control) Command. This option only works with ASCII data.

---

### 2.1.3. Transparent Operation

---

By default, XTend RF Modules operate in Transparent Mode. The modules act as a serial line replacement - all UART data received through the DI pin is queued up for RF transmission. When RF data is received, the data is sent out the DO pin.

When the RO (Packetization Timeout) parameter threshold is satisfied, the module attempts to initialize an RF transmission. If the module cannot immediately transmit (for instance, if it is already receiving RF data), the serial data continues to be stored in the DI Buffer. Data is packetized and sent at any RO timeout or when the maximum packet size is received.

The module operates as described above unless the Command Mode Sequence is detected. The Command Mode Sequence consists of three copies of the command sequence character [CC parameter] surrounded by the before and after guard times [BT & AT parameters].

If the DI buffer becomes full, hardware or software flow control must be implemented in order to prevent overflow (loss of data between the host and module).

---

### 2.1.4. API Operation

---

API (Application Programming Interface) Operation is an alternative to the default Transparent Operation. The API is frame-based and extends the level to which a host application can interact with the networking capabilities of the module. When in API mode, all data entering and leaving the RF module is contained in frames that define operations or events within the module.

Transmit Data Frames (received through the DI (Data In) pin) include:

- 16-bit address

Receive Data Frames (sent out the DO (Data Out) pin) include:

- Showing a received RF packet (16 bits only)
- Response to a TX (Transmit) packet
- Showing events such as hardware reset, watchdog reset, asynchronous events, etc.

The module will send data frames to the application containing status packets; as well as source, RSSI and payload information from received data packets.

API operation option facilitates many operations such as the examples cited below:

- |  |
|--|
| <ul style="list-style-type: none"><li>-&gt; Change destination addresses without having to enter command mode</li><li>-&gt; Receive success/failure status of each RF packet</li><li>-&gt; Identify the source address of each received packet</li></ul> |
|--|

---

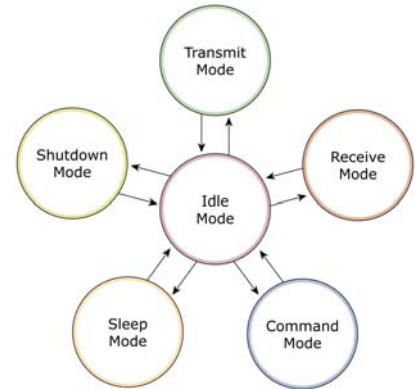
To implement API operations, refer to 'API Operation' sections [p40].

---

## 2.2. Modes of Operation

XTend RF Modules operate in six modes.

**Figure 2-04. XTend RF Module Modes of Operation**  
(RF modules can only be in one mode at a time)



### 2.2.1. Idle Mode

When not receiving or transmitting data, the RF module is in Idle Mode. The module shifts into the other modes of operation under the following conditions:

- Transmit Mode: Serial data is received in the DI Buffer
- Receive Mode: Valid RF data is received through the antenna
- Shutdown Mode: Shutdown condition is met
- Sleep Mode: Sleep Mode condition is met
- Command Mode: Command Mode Sequence is issued

The module automatically transitions back to Idle Mode after responding to these conditions.

### 2.2.2. Transmit Mode

When the first byte of serial data is received from the UART in the DI buffer, the module attempts to shift to Transmit Mode and initiate an RF connection with other modules. After transmission is complete, the module returns to Idle Mode.

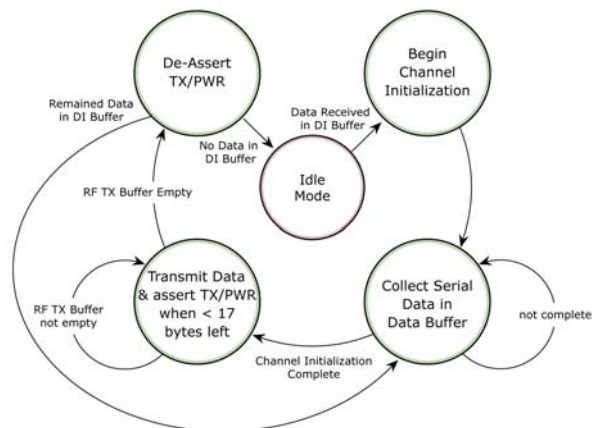
**RF transmission begins after either of the following criteria is met:**

1. RB bytes have been received by the UART and are pending for RF transmission. [Refer to the RB (Packetization Threshold) Command]
2. At least one character has been received by the UART and is pending for RF transmission; and RO character times of silence been observed on the UART. [Refer to the RO (Packetization Timeout) Command]

**Figure 2-05. Transmit Mode Data Flow**

The character timeout trigger can be disabled by setting RO to zero. In this case, transmission will not begin until RB bytes have been received and are pending for RF transmission. The RB parameter may be set to any value between 1 and the RF packet size [refer to PK (Max RF Packet Size) parameter], inclusive. Note that transition to Transmit Mode cannot take place during RF reception; the RF reception must complete before the radio can transition into Transmit Mode.

If RB or RO conditions are met, the module initializes a communications channel. Serial data in the DI buffer is grouped into RF packets (up to 2048 bytes in each packet, refer to PK Command), converted to RF data and is transmitted over-the-air until the DI buffer is empty.



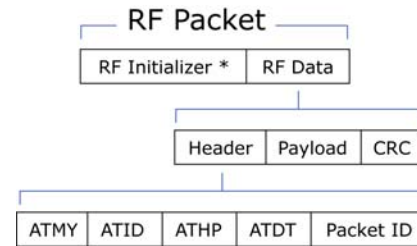
Channel initialization is the process of sending an RF initializer that synchronizes receiving modules with the transmitting module. During channel initialization, incoming serial data accumulates in the DI buffer.

RF data, which includes the payload data, follows the RF initializer. The payload includes up to the maximum packet size (PK Command) bytes. As the TX module nears the end of the transmission, it inspects the DI buffer to see if more data exists to be transmitted. This could be the case if more than PK bytes were originally pending in the DI buffer or if more bytes arrived from the UART after the transmission began. If more data is pending, the transmitting module assembles a subsequent packet for transmission.

Refer to the 'RF Communication Modes' section to view state diagrams that illustrate channel initialization and the sequence of events that follow.

## RF Packet

Figure 2-06. RF Packet Components



\* When streaming multiple RF packets, the RF Initializer is only sent in front of the first packet.

### RF Initializer

An RF initializer is sent each time a new connection sequence begins. The RF initializer contains channel information that notifies receiving modules of information such as the hopping pattern used by the transmitting module. The first transmission always sends an RF initializer.

An RF initializer can be of various lengths depending on the amount of time determined to be required to prepare a receiving module. For example, a wake-up initializer is a type of RF initializer used to wake remote modules from Sleep Mode (Refer to the FH, LH, HT and SM Commands for more information). The length of the wake-up initializer should be longer than the length of time remote modules are in cyclic sleep.

### Header

The header contains network addressing information that filters incoming RF data. The receiving module checks for matching a Hopping Channel, VID and Destination Address. Data that does not pass through all three network filter layers is discarded.

Refer to the 'Addressing' section of the "RF Communication Modes" chapter for more information.

### CRC (Cyclic Redundancy Check)

To verify data integrity and provide built-in error checking, a 16-bit CRC (Cyclic Redundancy Check) is computed for the transmitted data and attached to the end of each RF packet. On the receiving end, the receiving module computes the CRC on all incoming RF data. Received data that has an invalid CRC is discarded [refer to the 'Receive Mode' section].

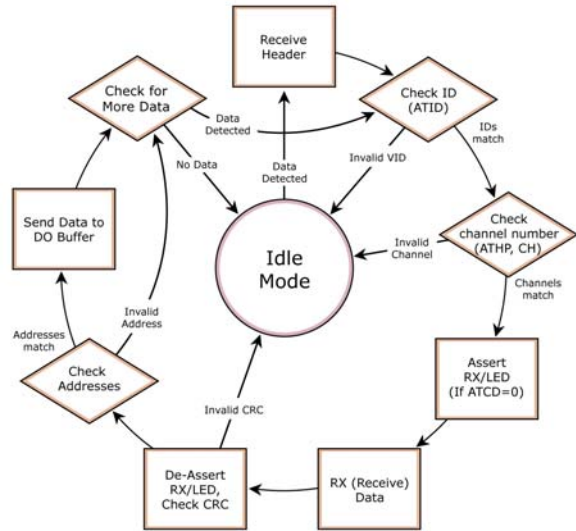
### 2.2.3. Receive Mode

If a module detects RF data while operating in Idle Mode, the module transitions to Receive Mode to start receiving RF packets. Once a packet is received, the module checks the CRC (cyclic redundancy check) to ensure that the data was transmitted without error. If the CRC data bits on the incoming packet are invalid, the packet is discarded. If the CRC is valid, the packet proceeds to the DO Buffer.

**Figure 2-07. Receive Mode Data Flow**

\* Refer to the 'Address Recognition' section for more information regarding address recognition.

The module returns to Idle Mode when valid RF data is no longer detected or after an error is detected in the received RF data. If serial data is stored in the DI buffer while the module is in Receive Mode, the serial data will be transmitted after the module is finished receiving data and returns to Idle Mode.



### 2.2.4. Shutdown Mode

#### Hardware Sleep

For applications where power consumption must be kept to a minimum during idle periods, Shutdown Mode offers the lowest power mode available to the module.

When the  $\overline{\text{SHDN}}$  pin (pin 7) is driven low, the module is forced into shutdown mode. Any communication in progress (transmit or receive) will be halted and any buffered data will be lost. For any other mode of operation, SHDN must be driven or pulled high. While in shutdown mode, the module's VCC pin draws 5  $\mu\text{A}$  (typical).

Immediately after the  $\overline{\text{SHDN}}$  pin changes state from low to high, the module resets. After reset, there is a delay that must be observed. Delay time is < 100ms.

While  $\overline{\text{SHDN}}$  pin is driven low, the following pins are set to high impedance by the module: DCD, TX\_PWR, RX LED, DO and CTS (See pin signal descriptions, p6). The  $\overline{\text{SHDN}}$  line (also used for RSSI indication) is driven low during shutdown.

The following input pins may continue to be driven by external circuitry when in shutdown mode: PIN\_PWR\_DWN,  $\overline{\text{RTS}}$ , DI and  $\overline{\text{SHDN}}$ .

Note: Because the DO pin also goes high impedance, if the XTend RF Module is connected to a processor, the UART receive pin could be floating. A weak pull-up should be placed between the module and the microcontroller so that data is not interpreted as being transmitted to the microprocessor.

## 2.2.5. Sleep Mode

### Software Sleep

Sleep Modes enable the module to enter states of low-power consumption when not in use. Three software Sleep Modes are supported:

- Pin Sleep (Host Controlled)
- Serial Port Sleep (Wake on Serial Port activity)
- Cyclic Sleep (Wake on RF activity)

In order to enter Sleep Mode, one of the following conditions must be met (in addition to the module having a non-zero SM parameter value):

1. The module is idle (no data transmission or reception) for the amount of time defined by the ST (Time before Sleep) parameter. [NOTE: ST is only active when SM = 4-5.]
2. SLEEP (pin 8) is asserted (only for the 'Pin Sleep' option).

When in Sleep Mode, the module will not transmit or receive data until the module first transitions to Idle Mode. All Sleep Modes are enabled and disabled using SM Command. Transitions into and out of Sleep Modes are triggered by various mechanisms as shown in the table below.

**Table 2-01. Summary of Sleep Mode Configurations**

Sleep Mode (Setting)	Transition into Sleep Mode	Transition out of Sleep Mode (wake)	Related Commands	Power Consumption
Pin Sleep (SM = 1)	Assert (high) SLEEP pin - A micro controller can shut down and wake modules via the SLEEP pin. Note: The module will complete a transmission or reception before activating Pin Sleep.	De-assert (low) SLEEP pin	(SM)	< 147 $\mu$ A
Serial Port Sleep (SM = 2)	Automatic transition to Sleep Mode occurs after a user-defined period of inactivity (no transmitting or receiving of data). Period of inactivity is defined by the ST (Time before Sleep) Command.	When a serial byte is received on the DI pin	(SM), ST	< 10 mA
Cyclic Sleep (SM = 4 - 8)	RF module transitions in and out of Sleep Mode in cycles (user-selectable wake-up interval of time is set using the SM command). The cyclic sleep interval of time must be shorter than the interval of time that is defined by the LH (Wake-up Initializer Timer) command. Note: The module can be forced into Idle Mode using the SLEEP pin if the PW (Pin Wake-up) command is issued.		(SM), ST, HT, LH, PW	< 1.6 mA when sleeping (SM=4, 1 sec., @120K baud)

The SM (Sleep Mode) command is central to setting all Sleep Mode configurations. By default, Sleep Modes are disabled (SM = 0) and the module remains in Idle/Receive Mode. When in this state, the module remains constantly ready to respond to serial or RF activity.

Refer to the 'Hardware Sleep' section of the 'Shutdown Mode' section [previous page] to enable the module's lowest power-consuming state (5  $\mu$ A typical power-down current).

#### Pin Sleep (SM = 1)

- Pin/Host-controlled
- Typical power-down current: < 147  $\mu$ A

This mode is voltage level activated. When the SLEEP pin is asserted, the module will finish any transmitting or receiving activity; enter Idle Mode; then enter a state of sleep. When in Pin Sleep Mode, the module will not respond to serial or RF activity.

After enabling Pin Sleep, the SLEEP pin controls whether the module is active or sleeping. When SLEEP is de-asserted, the module is fully operational. When SLEEP is asserted, the module transitions to Sleep Mode and remains in its lowest power-consuming state until the pin is de-asserted. This pin is only active if the module is setup to operate in this mode; otherwise the pin is ignored.

Once in Pin Sleep,  $\overline{\text{CTS}}$  (GPO1) is de-asserted (high), indicating that data should not be sent to the module. The PWR pin is also de-asserted (low) when the module is in Pin Sleep Mode.

Note: The module will complete a transmission or reception before activating Pin Sleep.

**Serial Port Sleep (SM = 2)**

- Wake on serial port activity
- Typical power-down current: < 10 mA

Serial Port Sleep is a Sleep Mode in which the module runs in a low power state until serial data is detected on the DI pin.

The period of time the module sleeps is determined by ST (Time before Sleep) Command. Once a character is received through the DI pin, the module returns to Idle Mode and is fully operational.

**Cyclic Sleep (SM = 4-8)**

- Typical Power-down Current: < 1.6 mA (when asleep)

Cyclic Sleep Modes allow modules to periodically wake and check for RF data. The module wakes according to the times designated by the Cyclic sleep settings. If the module detects a wake-up initializer during the time it is awake, the module synchronizes with the transmitting module and receives data after the wake-up initializer runs its duration. Otherwise, the module returns to Sleep Mode and continues to cycle in and out of activity until a wake-up initializer is detected.

While the module is in Cyclic Sleep Mode,  $\overline{\text{CTS}}$  (GPO1) is de-asserted (high) to indicate that data should not be sent to the module. When the module awakens to listen for data, GPO1 is asserted and any data received on the DI Pin is transmitted. The PWR pin is also de-asserted (low) when the module is in Cyclic Sleep Mode.

The module remains in Sleep Mode for a user-defined period of time ranging from 0.5 seconds to 16 seconds (SM parameters 4 through 8). After this interval of time, the module returns to Idle Mode and listens for a valid data packet for 100 ms. If the module does not detect valid data (on any frequency), the module returns to Sleep Mode. If valid data is detected, the module transitions into Receive Mode and receives the incoming RF packets. The module then returns to Sleep Mode after a period of inactivity determined by the ST "Time before Sleep" parameter.

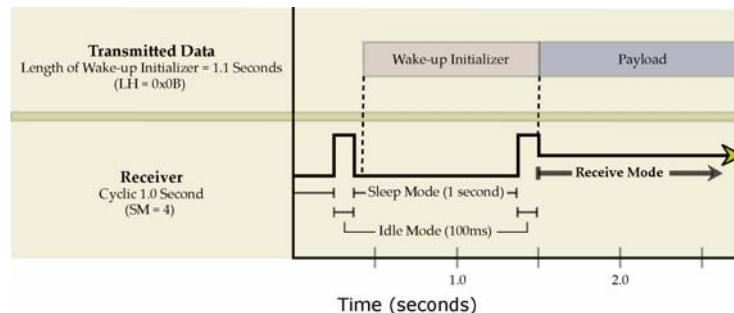
The module can also be configured to wake from cyclic sleep when the SLEEP pin is de-asserted. To configure a module to operate in this manner, PW (Pin Wake-up) Command must be issued. Once the SLEEP pin is de-asserted, the module is forced into Idle Mode and can begin transmitting or receiving data. It remains active until data is no longer detected for the period of time specified by the ST Command, at which point it resumes its low-power cyclic state.

**Cyclic Scanning.** Each RF transmission consists of an RF Initializer and payload. The RF initializer contains initialization information and all receiving modules must wake during the wake-up initializer portion of data transmission in order to be synchronized with the transmitting module and receive the data.

The cyclic interval time defined by the SM (Sleep Mode) command must be shorter than the interval time defined by LH (Wake-up Initializer Timer) command.

**Figure 2-08. Correct Configuration (LH > SM):**

The length of the wake-up initializer exceeds the time interval of Cyclic Sleep. The receiver is guaranteed to detect the wake-up initializer and receive the accompanying payload data.





## 2.2.6. Command Mode

To modify or read module parameters, the module must first enter into Command Mode (state in which incoming characters are interpreted as commands). Two command types are supported:

- AT Commands
- Binary Commands

For modified parameter values to persist in the module registry, changes must be saved to non-volatile memory using the WR (Write) command. Otherwise, parameters are restored to previously saved values when the module is powered off and then on again.

### AT Command Mode

#### To Enter AT Command Mode:

1. Send the 3-character command sequence "+++" and observe guard times before and after the command characters. [refer to 'Default AT Command Mode Sequence' below.] The 'Terminal' tab (or other serial communications software) of the X-CTU Software can be used to enter the sequence.  
[OR]
2. Assert (low) the CONFIG pin and turn the power going to the module off and back on (or pulse the SHDN pin).  
[If the module is mounted to a MaxStream RS-232/485 Interface Board, the result can be achieved by pressing the configuration switch down for 2 seconds.]

Default AT Command Mode Sequence (for transition to Command Mode):

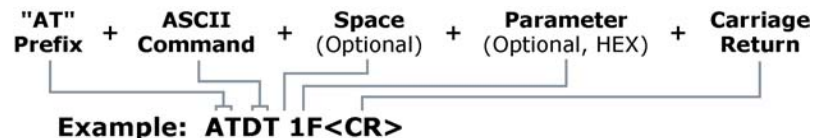
- No characters sent for one second [refer to the BT (Guard Time Before) Command]
- Input three plus characters ("+++") within one second [refer to the CC (Command Sequence Character) Command.]
- No characters sent for one second [refer to the AT (Guard Time After) Command.]

All of the parameter values in the sequence can be modified to reflect user preferences.

#### To Send AT Commands:

Send AT commands and parameters using the syntax shown below.

Figure 2-09. Syntax for sending AT Commands



To read a parameter value stored in the module register, leave the parameter field blank.

The preceding example would change the module's Destination Address to "0x1F". To store the new value to non-volatile (long term) memory, the Write (ATWR) command must subsequently be sent before powering off the module.

**System Response.** When a command is sent to the module, the module will parse and execute the command. Upon successful execution of a command, the module returns an "OK" message. If execution of a command results in an error, the module returns an "ERROR" message.

#### To Exit AT Command Mode:

1. If no valid AT Commands are received within the time specified by CT (Command Mode Timeout) Command, the module automatically returns to Idle Mode.  
[OR]
2. Send ATCN (Exit Command Mode) Command.

For an example of programming the RF module using AT Commands and descriptions of each configurable parameter, refer to the "RF Module Configuration" chapter [p19].

**Binary Command Mode**

Sending and receiving parameter values using binary commands is the fastest way to change operating parameters of the module. Binary commands are used most often to sample signal strength [refer to DB (Received Signal Strength) parameter] and/or error counts; or to change module addresses and channels for polling systems when a quick response is necessary. Since the sending and receiving of parameter values takes place through the same serial data path as 'live' data (received RF payload), interference between the two types of data can be a concern.

Common questions about using binary commands:

- What are the implications of asserting CMD while live data is being sent or received?
- After sending serial data, is there a minimum time delay before CMD can be asserted?
- Is a time delay required after CMD is de-asserted before payload data can be sent?
- How does one discern between live data and data received in response to a command?

The CMD pin (pin 10) must be asserted in order to send binary commands to the module. The CMD pin can be asserted to recognize binary commands anytime during the transmission or reception of data. The status of the CMD signal is only checked at the end of the stop bit as the byte is shifted into the serial port. The application does not allow control over when data is received, except by waiting for dead time between bursts of communication.

If the command is sent in the middle of a stream of payload data to be transmitted, the command will essentially be executed in the order it is received. If the module is continuously receiving data, the radio will wait for a break in the received data before executing the command. The CTS signal will frame the response coming from the binary command request [refer to figure below].

A minimum time delay of 100 μs (after the stop bit of the command byte has been sent) must be observed before the CMD pin can be de-asserted. The command executes after all parameters associated with the command have been sent. If all parameters are not received within 0.5 seconds, the module returns to Idle Mode.

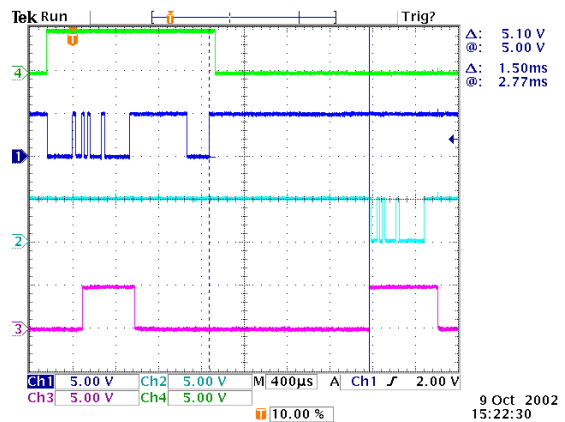
Note: When parameters are sent, they are two bytes long with the least significant byte sent first. Binary commands that return one parameter byte must be written with two parameter bytes.

Commands can be queried for their current value by sending the command logically ORed (bit-wise) with the value 0x80 (hexadecimal) with CMD asserted. When the binary value is sent (with no parameters), the current value of the command parameter is sent back through the DO pin.

**Figure 2-010. Binary Command Write then Read**

- Signal #4 is CMD
- Signal #1 is the DI signal
- Signal #2 is the DO signal from the radio
- Signal #3 is CTS

In this graph, a value was written to a register and then read out to verify it. While not in the middle of other received data, note that the CTS signal outlines the data response out of the module.



**IMPORTANT:** In order for the module to recognize a binary command, the RT (GPI1 Configuration) parameter must be set to one. If binary programming is not enabled (RT parameter value is not equal to '1'), the module will not recognize that the CMD pin is asserted and therefore will not recognize the data as binary commands.

Refer to [p19] for a binary programming example (DT command example returns two bytes).

# 3. RF Module Configuration

## 3.1. Programming Examples

Refer to the 'Command Mode' section [p17] for information regarding entrance into Command Mode, sending AT commands and exiting Command Mode. Refer to the 'X-CTU' section [p69] of the 'Development Guide' for more information regarding MaxStream's configuration software.

### 3.1.1. AT Commands

**To Send AT Commands** (Using the 'Terminal' tab of the X-CTU Software)

Example: Utilize the 'Terminal' tab of the X-CTU Software to change the module's DT (Destination Address) parameter and save the new address to non-volatile memory. This example requires the installation of MaxStream's X-CTU Software and a serial connection to a PC. Select the 'Terminal' tab of the X-CTU Software and enter the following command lines:

Method 1 (One line per command)

Send AT Command	System Response
+++	OK <CR> (Enter into Command Mode)
ATDT <Enter>	{current value} <CR> (Read Destination Address)
ATDT1A0D <Enter>	OK <CR> (Modify Destination Address)
ATWR <Enter>	OK <CR> (Write to non-volatile memory)
ATCN <Enter>	OK <CR> (Exit Command Mode)

Method 2 (Multiple commands on one line)

Send AT Command	System Response
+++	OK <CR> (Enter into Command Mode)
ATDT <Enter>	{current value} <CR> (Read Destination Address)
ATDT1A0D,WR,CN <Enter>	OK <CR> (Execute commands)

Note: Do not send commands to the module during flash programming (when parameters are being written to the module registry).

Wait for the "OK" system response that follows the ATWR command before entering the next command or use flow control.

Note: When using X-CTU Software to program a module, PC com port settings must match the baud (interface data rate), parity & stop bits parameter settings of the module. Use the 'Com Port Setup' section of the "PC Settings" tab to configure PC com port settings to match those of the module.

### 3.1.2. Binary Commands

**To Send Binary Commands:**

Example: Use binary commands to change the RF module's destination address to 0x1A0D and save the new address to non-volatile memory.

1. RT Command must be set to '1' in AT Command Mode to enable binary programming.
2. Assert CMD (Pin 10 is driven high). (Enter Binary Command Mode)
3. Send Bytes [parameter bytes must be 2 bytes long]:

00	(Send DT (Destination Address) Command)
0D	(Least significant byte of parameter bytes)
1A	(Most significant byte of parameter bytes)
08	(Send WR (Write) Command)
4. De-assert CMD (pin 10 is driven low). (Exit Binary Command Mode)

Note:  $\overline{\text{CTS}}$  (pin 9) is high when a command is being executed. Hardware flow control must be disabled as  $\overline{\text{CTS}}$  will hold off parameter bytes.

## 3.2. Command Reference Table

**Table 3-01. XTend Commands** (The RF modules expect numerical values in hexadecimal. Hexadecimal values are designated by a "0x" prefix. Decimal equivalents are designated by a "d" suffix.)

AT Command	Binary Command	AT Command Name	Parameter Range	Command Category	# Bytes Returned	Factory Default
%V	0x3B (59d)	Board Voltage	0x2CCCA - 0x5BFFA [read-only]	Diagnostics	4	--
AM	0x40 (64d)	Auto-set MY	--	Networking & Security	--	--
AP v2.x20*	--	API Enable	0 - 2	Serial Interfacing	1	0
AT	0x05 (5d)	Guard Time After	2 - (ATST-3) [x 100 msec]	Command Mode Options	2	0x0A (10d)
BD	0x15 (21d)	Interface Data Rate	0 - 8 (standard rates) 0x39 - 0x1C9C38 (non-standard rates)	Serial Interfacing	4	3
BR	0x39 (57d)	RF Data Rate	0 - 1	RF Interfacing	1	1
BT	0x04 (4d)	Guard Time Before	0 - 0xFFFF [x 100 msec]	Command Mode Options	2	0x0A (10d)
CC	0x13 (19d)	Command Sequence Character	0x20 - 0x7F	Command Mode Options	1	0x2B ["+"] (43d)
CD	0x28 (40d)	GPO2 Configuration	0 - 4	Serial Interfacing	1	2
CF	--	Number Base	0 - 2	Command Mode Options	1	1
CN	0x09 (9d)	Exit Command Mode	--	Command Mode Options	--	--
CS	0x1F (31d)	GPO1 Configuration	0 - 4	Serial Interfacing	1	0
CT	0x06 (6d)	Command Mode Timeout	2 - 0xFFFF [x 100 ms]	Command Mode Options	2	0xC8 (200d)
DB	0x36 (54d)	Received Signal Strength	0x6E - 0x28 [read-only]	Diagnostics	2	--
DT	0x00 (0d)	Destination Address	0 - 0xFFFF	Networking & Security	2	0
E0	0x0A (10d)	Echo Off	--	Command Mode Options	--	--
E1	0x0B (11d)	Echo On	--	Command Mode Options	--	--
ER	0x0F (15d)	Receive Error Count	0 - 0xFFFF	Diagnostics	2	0
FH	0x0D (13d)	Force Wake-up Initializer	--	Sleep (Low Power)	--	--
FL	0x07 (7d)	Software Flow Control	0 - 1	Serial Interfacing	1	0
FS	0x3E (62d)	Forced Sync Time	0 - 0xFFFF [x 10 msec]	RF Interfacing	2	0
FT	0x24 (36d)	Flow Control Threshold	0 - (DI buffer size - 0x11) [Bytes]	Serial Interfacing	2	DI buffer size minus 0x11
GD	0x10 (16d)	Receive Good Count	0 - 0xFFFF	Diagnostics	2	0
HP	0x11 (17d)	Hopping Channel	0 - 9	Networking & Security	1	0
HT	0x03 (3d)	Time before Wake-up Initializer	0 - 0xFFFF [x 100 msec]	Sleep (Low Power)	2	0xFFFF (65535d)
HV	--	Hardware Version	0 - 0xFFFF [read-only]	Diagnostics	2	--
ID	0x27 (39d)	Modem VID	0x11 - 0x7FFF (user-settable) 0x8000 - 0xFFFF (factory-set, read-only)	Networking & Security	2	0x3332 (13106d)
KY	0x3C (60d)	AES Encryption Key	0 - (Any other 64-digit hex valid key)	Networking & Security	2	0
LH	0x0C (12d)	Wake-up Initializer Timer	0 - 0xFF [x 100 msec]	Sleep (Low Power)	1	1
MD v2.x20*	0x31 (49d)	RF Mode	0 - 6	Networking & Security	1	0
MK	0x12 (18d)	Address Mask	0 - 0xFFFF	Networking & Security	2	0xFFFF (65535d)
MT	0x3D (61d)	Multi-Transmit	0 - 0xFF	Networking & Security	1	0
MY	0x2A (42d)	Source Address	0 - 0xFFFF	Networking & Security	2	0xFFFF (65535d)
NB	0x23 (35d)	Parity	0 - 4	Serial Interfacing	1	0
PB v2.x20*	0x45 (69d)	Polling Begin Address	0 - 0xFFFF	Networking & Security	2	0
PD v2.x20*	0x47 (71d)	Minimum Polling Delay	0 - 0xFFFF (Base: (x 1 ms), Remote: [x 10 ms])	Networking & Security	2	0

**Table 3-01. XTend Commands** (The RF modules expect numerical values in hexadecimal. Hexadecimal values are designated by a "0x" prefix. Decimal equivalents are designated by a "d" suffix.)

AT Command	Binary Command	AT Command Name	Parameter Range	Command Category	# Bytes Returned	Factory Default
PE v2.x20*	0x46 (70d)	Polling End Address	0 - 0xFFFF	Networking & Security	2	0
PK	0x29 (41d)	Maximum RF Packet Size	1 - 0x800 [Bytes]	RF Interfacing	2	varies
PL	0x3A (58d)	TX Power Level	0 - 4	RF Interfacing	1	4 (1 Watt)
PW	0x1D (29d)	Pin Wake-up	0 - 1	Sleep (Low Power)	1	0
RB	0x20 (32d)	Packetization Threshold	1 - Current value of PK	Serial Interfacing	2	0x800 (2048d)
RC	--	Ambient Power - Single Channel	0 - 0x31 [dBm, read-only]	Diagnostics	1	--
RE	0x0E (14d)	Restore Defaults	--	(Special)	--	--
RM	--	Ambient Power - All Channels	No parameter - 0x7D0	Diagnostics	2	--
RN	0x19 (25d)	Delay Slots	0 - 0xFF [slots]	Networking & Security	1	0
RO	0x21 (33d)	Packetization Timeout	0 - 0xFFFF [x UART character time]	Serial Interfacing	2	3
RP	0x22 (34d)	RSSI PWM Timer	0 - 0xFF [x 100 msec]	Diagnostics	1	0x20 (32d)
RR	0x18 (24d)	Retries	0 - 0xFF	Networking & Security	1	0x0A (10d)
RT	0x16 (22d)	GPI1 Configuration	0 - 2	Serial Interfacing	1	0
SB	0x37 (55d)	Stop Bits	0 - 1	Serial Interfacing	1	0
SH	0x25 (37d)	Serial Number High	0 - 0xFFFF [read-only]	Diagnostics	2	varies
SL	0x26 (38d)	Serial Number Low	0 - 0xFFFF [read-only]	Diagnostics	2	varies
SM	0x01 (1d)	Sleep Mode	0 - 8 (3 is reserved)	Sleep (Low Power)	1	0
ST	0x02 (2d)	Time before Sleep	(ATAT+3) - 0x7FFF [x 100 msec]	Sleep (Low Power)	2	0x64 (100d)
TP	0x38 (56d)	Board Temperature	0 - 0x7F [read-only]	Diagnostics	1	--
TR	0x1B (27d)	Delivery Failure Count	0 - 0xFFFF [read-only]	Diagnostics	2	0
TT	0x1A (26d)	Streaming Limit	0 - 0xFFFF [0 = disabled]	Networking & Security	2	0
TX	0x3F (63d)	Transmit Only	0 - 1	RF Interfacing	1	0
VL	--	Firmware Version - verbose	Returns string	Diagnostics	--	--
VR	0x14 (20d)	Firmware Version	0 - 0xFFFF [read-only]	Diagnostics	2	--
WA	--	Active Warning Numbers	Returns string	Diagnostics	--	--
WN	--	Warning Data	Returns string	Diagnostics	--	--
WR	0x08 (8d)	Write	--	(Special)	--	--
WS	--	Sticky Warning Numbers	Returns string	Diagnostics	--	--

\* Firmware version in which command and parameter options were first supported

### 3.3. Command Descriptions

Commands in this section are listed alphabetically. Command categories are designated between the "< >" symbols that follow each command title. By default, XTend RF Modules expect numerical values in hexadecimal since the default value of the CF (Number Base) Parameter is '1'. Hexadecimal values are designated by the "0x" prefix and decimal values by the "d" suffix.

#### %V (Board Voltage) Command

<Diagnostics> %V Command is used to read the current voltage of the module circuit board.

Sample Output:

5.02 V (when ATCF = 0)  
5051F (when ATCF = 1) \*  
5.02 (when ATCF = 2)

\* When CF = 1 (default), a hex integer is shown that is equal to (voltage \* 65536d).

AT Command: AT%V

Binary Command: 0x3B (59 decimal)

Parameter Range (read-only):  
0x2CCCA – 0x5BFFA  
(2.80 – 5.75 decimal)

Number of bytes returned: 4

#### AM (Auto-set MY) Command

<Networking & Security> AM Command is used to automatically set the MY (Source Address) parameter from the factory-set serial number of the module. The address is formed with bits 29, 28 and 13-0 of the serial number (in that order). The resulting value is displayed as a result of this command.

AT Command: ATAM

Binary Command: 0x40 (64 decimal)

#### AP (API Enable) Command

<Serial Interfacing> The AP command is used to enable the module to operate using the frame-based API operation.

AT Command: ATAP

Parameter Range: 0 – 2

Parameter	Configuration
0	API Disabled (Transparent Operation)
1	API enabled (w/out escaped characters)
2	API enabled (with escaped characters)

Default Parameter Value:0

Number of Bytes Returned:1

Minimum Firmware Version Required: 2.x20

#### AT (Guard Time After) Command

<Command Mode Options> AT Command is used to set/read the time-of-silence that follows the command sequence character (CC Command) of the AT Command Mode Sequence (BT + CC + AT). By default, 1 second must elapse before and after the command sequence character.

The times-of-silence surrounding the command sequence character are used to prevent inadvertent entrance into AT Command Mode.

Refer to the 'AT Command Mode' section [p17] for more information regarding the AT Command Mode Sequence.

AT Command: ATAT

Binary Command: 0x05 (5 decimal)

Parameter Range: 2 – (ATST–3), up to 0x7FFC  
[x 100 milliseconds]

Default Parameter Value: 0x0A (10 decimal)

Number of bytes returned: 2

Related Commands: BT (Guard Time Before),  
CC (Command Sequence Character)

**BD (Interface Data Rate) Command**

<Serial Interfacing> The BD command is used to set and read the serial interface data rate (baud rate) used between the RF module and host. This parameter determines the rate at which serial data is sent to the module from the host. Modified interface data rates do not take effect until the CN (Exit AT Command Mode) command is issued and the system returns the 'OK' response.

When parameters 0-8 are sent to the module, the respective interface data rates are used (as shown in the table on the right).

The RF data rate is not affected by the BD parameter. If the interface data rate is set higher than the RF data rate, a flow control configuration may need to be implemented.

The range between standard and non-standard baud rates (0x09 - 0x38) is invalid.

**Non-standard Interface Data Rates:**

Any value above 0x38 will be interpreted as an actual baud rate. When a value above 0x38 is sent, the closest interface data rate represented by the number is stored in the BD register. For example, a rate of 19200 bps can be set by sending the following command line "ATBD4B00". NOTE: When using MaxStream's X-CTU Software, non-standard interface data rates can only be set and read using the X-CTU 'Terminal' tab. Non-standard rates are not accessible through the 'Modem Configuration' tab.

When the BD command is sent with a non-standard interface data rate, the UART will adjust to accommodate the requested interface rate. In most cases, the clock resolution will cause the stored BD parameter to vary from the parameter that was sent (refer to the table below). Reading the BD command (send "ATBD" command without an associated parameter value) will return the value actually stored in the module's BD register.

**Parameters Sent Versus Parameters Stored**

BD Parameter Sent (HEX)	Interface Data Rate (bps)	BD Parameter Stored (HEX)
0	1200	0
4	19,200	4
7	115,200	7
12C	300	12B
1C200	115,200	1B207

AT Command: ATBD

Binary Command: 0x15 (21 decimal)

Parameter Ranges: 0 - 8 (standard rates)  
0x39 - 0x1C9C38 (non-standard rates)

Parameter	Configuration (bps)
0	1200
1	2400
2	4800
3	9600
4	19200
5	38400
6	57600
7	115200
8	230400

Default Parameter Value: 3

Non-standard baud rates supported as of firmware v2.x20

Number of bytes returned: 4

**BR (RF Data Rate) Command**

<RF Interfacing> The BR command is used to set and read the RF data rate (rate that RF data is transmitted over-the-air) of the module.

AT Command: ATBR

Binary Command: 0x39 (57 decimal)

Parameter Range: 0 - 1

Parameter	Baud (bps) Configuration
0	9600
1	115200

Default Parameter Value: 1

Number of bytes returned: 1

**BT (Guard Time Before) Command**

<AT Command Mode Options> The CC command is used to set/read the ASCII character used between guard times of the AT Command Mode Sequence (BT + CC + AT). This sequence enters the module into AT Command Mode so that data entering the module (from the host) is recognized as commands instead of payload.

Refer to the 'AT Command Mode' section [p17] for more information regarding the AT Command Mode Sequence.

AT Command: ATCC

Binary Command: 0x13 (19 decimal)

Parameter Range: 0x20 – 0x7F

Default Parameter Value: 0x2B (ASCII "+")

Number of bytes returned: 1

Related Commands: AT (Guard Time After), BT (Guard Time Before)

**CC (Command Sequence Character) Command**

<AT Command Mode Options> The CC command is used to set/read the ASCII character used between guard times of the AT Command Mode Sequence (BT + CC + AT). This sequence enters the module into AT Command Mode so that data entering the module (from the host) is recognized as commands instead of payload.

Refer to the 'AT Command Mode' section [p17] for more information regarding the AT Command Mode Sequence.

AT Command: ATCC

Binary Command: 0x13 (19 decimal)

Parameter Range: 0x20 – 0x7F

Default Parameter Value: 0x2B (ASCII "+")

Number of bytes returned: 1

Related Commands: AT (Guard Time After), BT (Guard Time Before)

**CD (GPO2 Configuration) Command**

<Serial Interfacing> CD Command is used to select/read the behavior of the GPO2 line (pin 3).

AT Command: ATCD

Binary Command: 0x28 (40 decimal)

Parameter Range: 0 – 8 (standard rates)

Parameter	Configuration
0	RX LED
1	Default High
2	Default Low
3	(reserved)
4	RX LED (valid address only)

Default Parameter Value: 2

Number of bytes returned: 1

**CF (Number Base) Command**

<Command Mode Options> CF command is used to set/read the command formatting setting.

The following commands are always entered and read in hex, no matter the CF setting:

VR (Firmware Version)  
HV (Hardware Version)  
KY (AES Encryption Key)

AT Command: ATCF

Parameter Range: 0 – 2

Parameter	Configuration
0	Commands utilize default number base; decimal commands may output units
1	All commands forced to unsigned, unit-less hex
2	Commands utilize their default number base; no units are output

Default Parameter Value: 1

Number of bytes returned: 1



**CN (Exit AT Command Mode) Command**

<Command Mode Options> The CN command is used to explicitly exit the module from AT Command Mode.

AT Command: ATCN

Binary Command: 0x09 (9 decimal)

**CS (GPO1 Configuration) Command**

<Serial Interfacing> CS Command is used to select the behavior of the GPO1 pin (pin 9). This output can provide RS-232 flow control, control the TX enable signal (for RS-485 or RS-422 operations).

By default, GPO1 provides RS-232  $\overline{\text{CTS}}$  (Clear-to-Send) flow control.

AT Command: ATCS

Binary Command: 0x1F (31 decimal)

Parameter Range: 0 – 4

Parameter	Configuration
0	RS-232 $\overline{\text{CTS}}$ flow control
1	RS-485 TX enable low
2	High
3	RS-485 TX enable high
4	Low

Default Parameter Value: 0

Number of bytes returned: 1

Related Commands: RT (GPI1 Configuration), TO (GPO1 Timeout)

**CT (Command Mode Timeout) Command**

<Command Mode Options> The CT command is used to set and read the amount of inactive time that elapses before the module automatically exits from AT Command Mode and returns to Idle Mode.

Use the CN (Exit AT Command Mode) command to exit AT Command Mode manually.

AT Command: ATCT

Binary Command: 0x06 (6 decimal)

Parameter Range: 2 – 0xFFFF  
[x 100 milliseconds]

Default Parameter Value: 0xC8 (200d)

Number of bytes returned: 2

Related Command: CN (Exit AT Command Mode)

**DB (Received Signal Strength) Command**

<Diagnostics> DB Command is used to read the receive signal strength (in decibels relative to milliWatts) of the last received packet. This parameter is useful in determining range characteristics of the RF modules under various conditions.

In default mode, this command shows the power level in signed decimal format with the units (dBm). If CF = 1, the magnitude of the value is presented in unsigned hex. If CF = 2, the value is presented in decimal, but without the units.

Sample Output: -88 dBm (when ATCF = 0)  
58 (when ATCF = 1)  
-88 (when ATCF = 2)

NOTE: If the DB register is read before the module has received an RF packet, the module will return a value of 0x8000 (which means an RF packet has not yet been received).

AT Command: ATDB

Binary Command: 0x36 (54 decimal)

Parameter Range (read-only): 0x6E – 0x28  
(-110 to -40 Decimal)

Number of bytes returned: 2

**DT (Destination Address) Command**

<Networking & Security> DT Command is used to set/read the networking address of an RF module. The modules utilize three filtration layers: Vendor ID Number (ATID), Channel (ATHP), and Destination Address (ATDT). The DT command assigns an address to a module that enables it to communicate only with other modules having the same address. All modules that share the same DT parameter can communicate with each other.

RF modules in the same network with a different destination address (than that of the transmitter) will listen to all transmissions to stay synchronized, but will not send any of the data out their serial ports.

Refer to the 'Addressing' section [p44] for more information.

AT Command: ATDT

Binary Command: 0x00

Parameter Range: 0 – 0xFFFF

Default Parameter Value: 0

Number of bytes returned: 2

Related Commands: HP (Hopping Channel), ID (Modem VID), MK (Address Mask), MY (Source Address)

**E0 (Echo Off) Command**

<Command Mode Options> E0 Command turns off character echo in AT Command Mode.

By default, echo is off.

AT Command: ATE0

Binary Command: 0x0A (10 decimal)

**E1 (Echo On) Command**

<Command Mode Options> E1 Command enables character echo in AT Command Mode. Each typed character will be echoed back to the terminal when ATE1 is active. E0 (Echo Off) is the default.

AT Command: ATE1

Binary Command: 0x0B (11 decimal)

**ER (Receive Error Count) Command**

<Diagnostics> The ER command is used to set/read the number of receive-errors. The error count records the number of packets partially received then aborted on a reception error. This value returns to 0 after a reset and is not non-volatile (Value does not persist in the module's memory after a power-up sequence). Once the Receive Error Count reaches its maximum value (up to 0xFFFF), it remains at its maximum count value until the maximum count value is explicitly changed or the module is reset.

The ER parameter is not reset by pin, serial port or cyclic sleep modes.

AT Command: ATER

Binary Command: 0x0F (15 decimal)

Parameter Range: 0 – 0xFFFF

Default Parameter Value: 0

Number of bytes returned: 2

Related Commands: GD (Receive Good Count)

**FH (Force Wake-up Initializer) Command**

<Sleep (Low Power)> The FH command is used to force a Wake-up Initializer to be sent on the next transmission. Use only with cyclic sleep modes active on remote modules.

ATFH will not send a long header if ATHT = 0xFFFF. WR (Write) Command does not need to be issued with FH Command.

AT Command: ATFH

Binary Command: 0x0D (13 decimal)

**FL (Software Flow Control) Command**

<Serial Interfacing> The FL command is used to configure software flow control. Hardware flow control is implemented with the module as the GP01 pin (CTS pin of the OEM RF module), which regulates when serial data can be transferred to the module.

FL Command can be used to allow software flow control to also be enabled. The XON character used is 0x11 (17 decimal). The XOFF character used is 0x13 (19 decimal)

AT Command: ATFL

Binary Command: 0x07 (7 decimal)

Parameter Range: 0 – 1

Parameter	Configuration
0	Disable software flow control
1	Enable software flow control

Default Parameter Value: 0

Number of bytes returned: 1

**FS (Forced Synch Time) Command**

<RF Interfacing> The FS command only applies to streaming data. Normally, only the first packet of a continuous stream contains the full RF initializer. The RF modules then remain synchronized for subsequent packets of the stream. This parameter can be used to periodically force an RF initializer during such streaming. Any break in UART character reception long enough to drain the DI Buffer (UART receive buffer) and cause a pause in RF data transmission will also cause an RF initializer to be inserted on the next transmission.

AT Command: ATFS

Binary Command: 0x3E (62 decimal)

Parameter Range: 0 – 0xFFFF  
[x 10 milliseconds]

Default Parameter Value: 0

Number of bytes returned: 2

**FT (Flow Control Threshold) Command**

<Serial Interfacing> The FT command is used to set/read the flow control threshold. When FT bytes have accumulated in the DI buffer (UART Receive), CTS is de-asserted or the XOFF software flow control character is transmitted.

AT Command: ATFT

Binary Command: 0x24 (36 decimal)

Parameter Range:  
0 – (DI buffer size minus 0x11) [Bytes]

Default Parameter Value: DI Buffer size minus 0x11 (17 decimal)

Number of bytes returned: 2

**GD (Receive Good Count) Command**

<Diagnostics> The GD command is used to set/read the count of good received RF packets. Its parameter value is reset to 0 after every reset and is not non-volatile (The parameter value does not persist in the RF module's memory after a power-up sequence). Once the "Receive Good Count" reaches its maximum value (up to 0xFFFF), it remains at its maximum count value until the maximum count value is manually changed or the module is reset.

The GD parameter is not reset by pin, serial port or cyclic sleep modes.

AT Command: ATGD

Binary Command: 0x10 (16 decimal)

Parameter Range: 0 – 0xFFFF

Default Parameter Value: 0

Number of bytes returned: 2

Related Commands: ER (Receive Error Count)

**HP (Hopping Channel) Command**

<Networking & Security> The HP command is used to set/read the RF module's hopping channel number. A channel is one of three layers of filtration available to the module.

In order for modules to communicate with each other, the modules must have the same channel number since each channel uses a different hopping sequence. Different channels can be used to prevent modules in one network from listening to transmissions of another.

AT Command: ATHP

Binary Command: 0x11 (17 decimal)

Parameter Range: 0 – 9

Default Parameter Value: 0

Number of bytes returned: 1

Related Commands: ID (Modem VID), DT (Destination Address), MK (Address Mask)

**HT (Time before Wake-up Initializer) Command**

<Sleep (Low Power)> The HT command is used to set/read the time of inactivity (no serial or RF data is sent or received) before a wake-up initializer is sent by a TX (transmitting) RF module. The HT parameter should be set shorter than inactivity timeout [ST Command] time of any RX (receiving) modules operating in Cyclic Sleep (SM=4-8). The wake-up initializer sent by the TX module instructs all RX modules to remain awake to receive RF data.

From the RX module perspective: After HT time elapses and the inactivity timeout [ST Command] is met, the RX module goes into cyclic sleep. In cyclic sleep, the RX module wakes once per sleep interval [SM Command] to check for a wake-up initializer. When a wake-up initializer is detected, the module stays awake to receive data. The wake-up initializer must be longer than the cyclic sleep interval to ensure that sleeping modules detect incoming data.

When HT time elapses, the TX module knows it needs to send a wake-up Initializer for all RX modules to remain awake and receive the next transmission.

AT Command: ATHT

Binary Command: 0x03 (3 decimal)

Parameter Range: 0 – 0xFFFF  
[x 100 milliseconds]

Default Parameter Value: 0xFFFF (wake-up initializer will not be sent)

Number of bytes returned: 2

Related Commands: LH (Wake-up Initializer Timer), SM (Sleep Mode), ST (Time before Sleep)

**HV (Hardware Version) Command**

<Diagnostics> The HV command is used to read the hardware version of the RF module.

AT Command: ATHV

Parameter Range: 0 – 0xFFFF [Read-only]

Minimum Firmware Version Required: v1.x80

**ID (Modem VID) Command**

<Networking & Security> The ID command is used to set/read the VID (Vendor Identification Number) of the RF module. RF modules must have matching VIDs in order to communicate.

AT Command: ATID

Binary Command: 0x27 (39 decimal)

Parameter Range:

0x11 – 0x7FFF (user-settable)

0 – 0x10 & 0x8000 – 0xFFFF (factory-set)

Default Parameter Value: 0x3332 (13106d)

Number of bytes returned: 2

**KY (AES Encryption Key) Command**

<Networking & Security> The KY command is used to set the 256-bit AES (Advanced Encryption Standard) key for encrypting/decrypting data. Once set, the key cannot be read out of the module by any means. The entire payload of the packet is encrypted using the key and the CRC is computed across the ciphertext. When encryption is enabled, each packet carries an additional 16 bytes to convey the random CBC Initialization Vector (IV) to the receiver(s). The KY value may be "0" or any 256-bit value (= 64 hex digits = 32 bytes). Any other value, including entering ATKY by itself with no parameters, causes an error.

A module with the wrong key (or no key) will receive encrypted data, but the data driven out the serial port will be meaningless. Likewise, a module with a key will receive unencrypted data sent from a module without a key, but the output will be meaningless. Because CBC mode is utilized, repetitive data appears differently in different transmissions due to the randomly-generated IV.

AT Command: ATKY
Binary Command: 0x3C (60 decimal)
Parameter Range: 0 – (any other 64–digit hex valid key)
Default Parameter Value: 0 (disabled)
Number of bytes returned: 2
Number Base: Always Hexadecimal

**LH (Wake-up Initializer Timer) Command**

<Sleep (Low Power)> The LH Command is used to set/read the duration of time during which the wake-up initializer is sent. When receiving modules are in Cyclic Sleep Mode, they power-down after a period of inactivity (as specified by the ST parameter) and will periodically wake and listen for transmitted data. In order for the receiving modules to remain awake, they must detect ~35ms of the wake-up initializer.

LH Command must be used whenever a receiving module is operating in Cyclic Sleep Mode. The Wake-up Initializer Time must be longer than the cyclic sleep time that [as determined by SM (Sleep Mode) parameter]. If the wake-up initializer time were less than the Cyclic Sleep interval, the connection would be at risk of missing the wake-up initializer transmission.

Refer to figures located under the SM command description to view diagrams of correct and incorrect configurations. The images emphasize that the LH value must be greater than the SM value.

AT Command: ATLH
Binary Command: 0x0C (12 decimal)
Parameter Range: 0 – 0xFF [x 100 milliseconds]
Default Parameter Value: 1
Number of bytes returned: 1
Related Commands: HT (Time before Wake-up Initializer), SM (Sleep Mode), ST (Time before Sleep)

**MD (RF Mode) Command**

<Networking & Security> The MD command is used to select/read the settings that enable the Polling and Repeater Modes on the module.

**Polling Mode** - A 'Polling Base' is responsible for polling remotes. A 'Polling Remote' requires a poll in order to transmit.

**Repeater Mode** - A 'Repeater' re-sends RF data unless the transmission is addressed to it or if the transmission has already been detected. A 'Repeater End Node' handles repeated messages, but will not repeat the message over-the-air.

Refer to the Polling and Repeater Mode sections of the 'RF Communication Modes' chapter for more information.

AT Command: ATMD																
Binary Command: 0x31 (49 decimal)																
Parameter Range: 0 – 6																
<table border="1"> <thead> <tr><th>Parameter</th><th>Configuration</th></tr> </thead> <tbody> <tr><td>0</td><td>Transparent Operation (Repeater Base)</td></tr> <tr><td>1</td><td>[reserved – not used]</td></tr> <tr><td>2</td><td>[reserved – not used]</td></tr> <tr><td>3</td><td>Polling Base</td></tr> <tr><td>4</td><td>Polling Remote</td></tr> <tr><td>5</td><td>Repeater</td></tr> <tr><td>6</td><td>Repeater End Node</td></tr> </tbody> </table>	Parameter	Configuration	0	Transparent Operation (Repeater Base)	1	[reserved – not used]	2	[reserved – not used]	3	Polling Base	4	Polling Remote	5	Repeater	6	Repeater End Node
Parameter	Configuration															
0	Transparent Operation (Repeater Base)															
1	[reserved – not used]															
2	[reserved – not used]															
3	Polling Base															
4	Polling Remote															
5	Repeater															
6	Repeater End Node															
Default Parameter Value: 0																
Number of bytes returned: 1																
Minimum Firmware Version Required: 2.x20																

**MK (Address Mask) Command**

<Networking & Security> The MK command is used to set/read the Address Mask of a module.

All RF data packets contain the Destination Address of the TX (transmitting) module. When a packet is received, the TX module Destination Address is logically "ANDed" (bitwise) with the Address Mask of the RX (receiving) module. The resulting value must match the Destination Address or Address Mask of the RX module for the packet to be received and sent out the RX module's DO (Data Out) pin. If the "ANDed" value does not match the Destination Address or Address Mask of the RX module, the packet is discarded.

**Sniffer Mode** (when MK = 0): ACK requests are ignored and every RX (receive) frame is sent to the UART, without regard for repeated frames.

All "0" values are treated as irrelevant values and ignored.

Refer to the 'Addressing' section [p44] for more information.

AT Command: ATMK

Binary Command: 0x12 (18 decimal)

Parameter Range: 0 – 0xFFFF

Default Parameter Value: 0xFFFF (65535d)

Number of bytes returned: 2

Related Commands: DT (Destination Address), HP (Hopping Channel), ID (Modem VID), MY (Source Address)

**MT (Multi-transmit) Command**

<Networking & Security> The MT command is used to enable multiple transmissions of RF data packets. When Multi-transmit Mode is enabled (MT > 0), packets do not request an ACK (acknowledgement) from the receiving RF module(s). MT takes precedence over RR, so if both MT and RR are non-zero, then MT+1 packets will be sent (with no ACK requests).

When a receiving module receives a packet with remaining forced retransmissions, it calculates the length of the packet and inhibits transmission for the amount of time required for all retransmissions. Thereafter, a random number of delay slots are inserted between 0 and RN before transmission is allowed from the receiving module(s). This prevents all listening modules from transmitting at once upon conclusion of a multiple transmission event (when RN > 0).

NOTE: The actual number of forced transmissions is the parameter value plus one. For example, if MT = 1, two transmissions of each packet will be sent.

Refer to the 'Multi-transmit Mode' section [p46] for more information.

AT Command: ATMT

Binary Command: 0x3D (61 decimal)

Parameter Range: 0 – 0xFF

Default Parameter Value: 0 (no forced retransmissions)

Number of bytes returned: 1

Related Commands: Networking (DT, MK, MY, RN, TT), Serial Interfacing (BR, PK, RB, RO), RF Interfacing (FS)

**MY (Source Address) Command**

<Networking & Security> The MY command is used to set/read the Source Address of the RF module.

Refer to the 'Addressing' section [p44] for more information.

AT Command: ATMY

Binary Command: 0x2A (42 decimal)

Parameter Range: 0 – 0xFFFF

Default Parameter Value: 0xFFFF (Disabled – DT (Destination Address) parameter serves as both source and destination address.)

Number of bytes returned: 2

Related Commands: DT (Destination Address), HP (Hopping Channel), ID (Modem VID), MK (Address Mask)

**NB (Parity) Command**

<Serial Interfacing> The NB command is used to select/read the parity settings of the RF module for UART communications.

AT Command: ATNB

Binary Command: 0x23 (35 decimal)

Parameter Range: 0 - 4

Parameter	Configuration
0	8-bit (no parity or 7-bit (any parity))
1	8-bit even
2	8-bit odd
3	8-bit mark
4	8-bit space

Default Parameter Value: 0

Number of bytes returned: 1

**PB (Polling Begin Address) Command**

<Networking & Security> PB command is used to set/read the module's Polling Begin Address - the first address polled Polling Mode is enabled.

**Polling Operations:** The 'Polling Base' (MD = 3) cycles through a sequential range of addresses, polling each 'Polling Remote' (MD = 4). The base then waits for a response & proceeds to the next 'Polling Remote'. Each 'Polling Remote' responds by sending the data from the Data In buffer following the RB & RO parameters. When there is no eligible data to send, the 'Polling Remote' will not respond. The 'Polling Base' will move to the next address in the polling sequence after a short delay.

AT Command: ATPB

Binary Command: 0x45 (69 decimal)

Parameter Range: 0 - 0xFFFF

Default Parameter Value: 0

Number of bytes returned: 2

Minimum Firmware Version Required: 2.x20

Related Commands: MD (RF Mode), PE (Polling End Address), PD (Minimum Polling Delay)

**PD (Minimum Polling Delay) Command**

<Networking & Security> The PD command is used to set/read Polling Delay (Base, MD=3) or Polling Timeout (Remote, MD=4).

**Polling Delay** (Base) is the time between polling cycles. The Polling Base will start the polling cycle after sending the first poll. After the polling cycle has completed, the timer is restarted.

**Polling Timeout** (Remote) is the amount of time the remote unit will hold data from the serial port before discarding it. Data entered within the PD time of the poll is transmitted and not discarded.

AT Command: ATPD

Binary Command: 0x47 (71 decimal)

Parameter Range: 0 - 0xFFFF  
(Base: [x 1ms], Remote: [x 10ms])

Default Parameter Value: 0

Number of bytes returned: 2

Minimum Firmware Version Required: 2.x20

Related Commands: MD (RF Mode), PB (Polling Begin Address), PE (Polling End Address)

**PE (Polling End Address) Command**

<Networking & Security> PE command is used to set/read the module's Polling End Address - the last address polled when Polling Mode is enabled.

**Polling Operations:** The 'Polling Base' (MD = 3) cycles through a sequential range of addresses, polling each 'Polling Remote' (MD = 4). The base then waits for a response & proceeds to the next 'Polling Remote'. Each 'Polling Remote' responds by sending data from the DI buffer following the RB & RO parameters. When there is no eligible data to send, the 'Polling Remote' will not respond. The 'Polling Base' will move to the next address in the polling sequence after a short delay.

AT Command: ATPE

Binary Command: 0x46 (70 decimal)

Parameter Range: 0 - 0xFFFF

Default Parameter Value: 0

Number of bytes returned: 2

Minimum Firmware Version Required: 2.x20

Related Commands: MD (RF Mode), PB (Polling Begin Address), PD (Minimum Polling Delay)

**PK (Maximum RF Packet Size) Command**

<RF Interfacing> The PK command is used to set/read the maximum size of RF packets transmitted from an RF module. The maximum packet size can be used along with the RB and RO parameters to implicitly set the channel dwell time.

If PK is set above 256 and BR is subsequently changed to 0, PK will automatically be lowered to 256 and a warning will be raised (refer to the BR (RF Data Rate) and WN (Warning Data) commands for details).

Changes to the PK parameter may have a secondary effect on the RB (Packetization Threshold) parameter. RB must always be less than or equal to PK. If PK is changed to a value that is less than the current value of RB, the RB value is automatically lowered to be equal to PK.

\* When BR = 0 (9600 baud), the maximum PK value is 0x100 (256d). When BR = 1 (115,200 baud), the maximum PK value is 0x800 (2048d).

AT Command: ATPK

Binary Command: 0x29 (41 decimal)

Parameter Range: 1 – 0x800 [Bytes]

Default Parameter Value: 0x100\* or 0x800\* (256 or 2048 decimal)

Number of bytes returned: 2

Related Commands: BR (RF Data Rate) RB (Packetization Threshold), RO (Packetization Timeout), WN (Warning Data)

**PL (TX Power Level) Command**

<RF Interfacing> The PL command is used to set/read the power level at which the RF module transmits data.

AT Command: ATPL

Binary Command: 0x3A (58 decimal)

Parameter Range: 0 – 4

Parameter	Configuration
0	1 mW
1	10 mW
2	100 mW
3	500 mW
4	1000 mW (1 Watt)

Default Parameter Value: 4

Number of bytes returned: 1

**PW (Pin Wake-up) Command**

<Sleep (Low Power)> Under normal operation, an RF module in Cyclic Sleep Mode cycles from an active state to a low-power state at regular intervals until data is ready to be received. If the PW parameter is set to 1, the SLEEP pin (pin 8) can be used to awaken the module from Cyclic Sleep. When the SLEEP Pin is de-asserted (low), the module will be fully operational and will not go into Cyclic Sleep.

Once the SLEEP pin is asserted, the module will remain active for the period of time specified by the ST (Time before Sleep) parameter and will return to Cyclic Sleep Mode (if no data is ready to be transmitted). PW Command is only valid if Cyclic Sleep has been enabled.

AT Command: ATPW

Binary Command: 0x1D (29 decimal)

Parameter Range: 0 – 1

Parameter	Configuration
0	Disabled
1	Enabled

Default Parameter Value: 0

Number of bytes returned: 1

Related Commands: SM (Sleep Mode), ST (Time before Sleep)



**RB (Packetization Threshold) Command**

<Serial Interfacing> The RB command is used to set/read the character threshold value.

RF transmission begins after data is received in the DI Buffer and either of the following criteria is met:

- RB characters received by the UART
- RO character times of silence detected on the UART receive lines (after receiving at least 1 Byte of data)

If PK (Max. RF Packet Size) is lowered below the value of RB, RB is automatically lowered to match the PK value. If (RO = 0), RB bytes must be received before beginning transmission.

Note: RB and RO criteria only apply to the first packet of a multi-packet transmission. If data remains in the DI Buffer after the first packet, transmissions will continue in a streaming manner until there is no data left in the DI Buffer (UART receive buffer).

AT Command: ATRB

Binary Command: 0x20 (32 decimal)

Parameter Range: 0 – PK parameter value (up to 0x800 Bytes)

Default Parameter Value: 0x800 Bytes

Number of bytes returned: 2

Related Commands: BR (RF Data Rate), PK (RF Packet Size), RO (Packetization Timeout)

**RC (Ambient Power - Single Channel) Command**

<Diagnostics> The RC command is used to examine and report the power level on a given channel.

Sample output: -78 dBm [when CF = 0]  
4e [when CF = 1]  
-78 [when CF = 2]

AT Command: ATRC

Parameter Range (read-only): 0 – 0x31 [dBm]

Number of bytes returned: 1

Related Commands: RM (Ambient Power – All Channels)

**RE (Restore Defaults) Command**

<Diagnostics> The RE command is used to restore all configurable parameters to their factory default settings.

The RE Command does not cause default values to be stored to non-volatile (persistent) memory. For the restored default settings to persist in the module's non-volatile memory and be saved in the event of RF module reset or power-down, the WR (Write) command must be issued prior to power-down or reset.

AT Command: ATRE

Binary Command: 0x0E (14 decimal)

**RM (Ambient Power - All Channels) Command**

<Diagnostics> The RM command is used to examine and report power levels on all channels. If no parameter is given, the channels are scanned one time. If a parameter is given, the channels are repeatedly scanned for that number of seconds. The maximum power level seen for each channel is reported (i.e. peak hold).

A graphical spectrum analyzer can be implemented by repeatedly sending the RM command (with no arguments) and reading the resultant 50 power levels (this is easiest to do when CF = 1 or 2).

Sample output [when CF = 0]: Ch 0: -100 dBm  
Ch 1: -103 dBm  
...  
Ch 49: -99 dBm

Sample output [when CF = 1]: 64  
67  
...  
63

Sample output [when CF = 2]: 100  
-103  
...  
-99

AT Command: ATRM

Parameter Range: no parameter – 0x7D0)

Number of bytes returned: 2

Related Commands: RC (Ambient Power – Single channel)

### RN (Delay Slots) Command

<Networking & Security> The RN command is used to set/read the time delay that the transmitting RF module inserts before attempting to resend a packet. If the transmitting module fails to receive an acknowledgement after sending a packet, it inserts a random number of delay slots (ranging from 0 to (RN minus 1)) before attempting to resend the packet. Each delay slot is 5 msec (when BR=1) and 54 msec (when BR=0).

If two modules attempt to transmit at the same time, the random time delay after packet failure allows only one module to transmit the packet successfully; while the other module waits until the channel available for RF transmission.

RN Command is only applicable if retries have been enabled [RR (Retries) Command] or if forced delays will be inserted into a transmission [TT (Streaming Limit) Command].

AT Command: ATRN

Binary Command: 0x19 (25 decimal)

Parameter Range: 0 – 0xFF [38 ms slots]

Default Parameter Value: 0  
(no delay slots inserted)

Number of bytes returned: 1

Related Commands: RR (Retries), TT (Streaming Limit)

### RO (Packetization Timeout) Command

<Serial Interfacing> The RO command is used to set/read the Packetization Timeout setting. RF transmission begins when data is in the DI buffer and either of the following criteria are met:

- RO character times of silence on the UART receive lines (after receiving at least 1 byte)
- RB characters have been received by the UART

RB and RO criteria only apply to the first packet of a multi-packet transmission. If data remains in the DI Buffer (UART receive) after the first packet, transmissions will continue in a streaming manner until there is no data left in the DI Buffer.

**When RO is the transmission-beginning criteria:** The actual time between the reception of the last character from the UART and the beginning of RF transmission will be at least 800 µsec longer than the actual RO time to allow for transmission setup. Additionally, it is subject to 100-200 µsec of additional uncertainty, which could be significant for small values of RO at high UART bit rates.

The correct UART character time (10, 11, or 12 bits) is calculated based on the following criteria:

- 1 start bit
- 8 data bits
- 0 or 1 parity bit [as determined by the NB (Parity) Command]
- 1 or 2 stop bits [as determined by SB (Stop Bits) Command]

AT Command: ATRO

Binary Command: 0x21 (33 decimal)

Parameter Range: 0 – 0xFFFF  
[ x UART character times ]

Default Parameter Value: 3

Number of bytes returned: 2

Related Commands: RB (Packetization Threshold)

**RP (RSSI PWM Timer) Command**

<Diagnostics> RP Command is used to enable a PWM ("Pulse Width Modulation") output on the Config/RSSI pin (pin 11 of the OEM RF Module). The pin is calibrated to show the difference between received signal strength and the sensitivity level of the RF module. PWM pulses vary from zero to 95 percent. Zero percent means the received RF signal is at or below the published sensitivity level of the module.

The following table shows dB levels above sensitivity and PWM values (The total time period of the PWM output is 8.32 ms. PWM output consists of 40 steps and therefore the minimum step size is 0.208 ms.):

**Table 3-02. PWM Values**

<b>dBm above sensitivity</b>	<b>PWM percentage (high period / total period)</b>
10	20%
20	35%
30	50%

A non-zero value defines the time that PWM output is active with the RSSI value of the last received RF packet. After the set time when no RF packets are received, PWM output is set low (0 percent PWM) until another RF packet is received. PWM output is also set low at power-up. A parameter value of 0xFF permanently enables PWM output and always reflects the value of the last received RF packet.

The Config/RSSI pin is shared between PWM output and Config input. When the module is powered, the Config pin is an input. During the power-up sequence, if RP parameter is a non-zero value, the Config pin is configured as an output and set low until the first RF packet is received. With a non-zero RP parameter, the Config pin is an input for RP ms after power up.

**RR (Retries) Command**

<Networking & Security> The RR command is used to set/read the maximum number of retries sent for a given RF packet. When RR Command is enabled (RR>0), RF packet retries and ACKs (acknowledgements) are enabled.

Exceptions: If the MT command is enabled (MT>0) or if a broadcast Destination Address is used (DT = 0xFFFF); RF packet retries and ACKs are disabled.

After transmitting a packet, the transmitting RF module waits to receive an acknowledgement from a receiving module. If the acknowledgement is not received in the period of time specified by RN (Delay Slots) Command, the original packet is transmitted again. The RF packet is transmitted repeatedly until an acknowledgement is received or until the packet is sent RR times.

AT Command: ATRP

Binary Command: 0x22 (34 decimal)

Parameter Range: 0 – 0xFF  
[x 100 milliseconds]

Default Parameter Value: 0x20 (32d)

Number of bytes returned: 1

AT Command: ATRR

Binary Command: 0x18 (24 decimal)

Parameter Range: 0 – 0xFF

Default Parameter Value: 0x0A (10 decimal)

Number of bytes returned: 1

**RT (GPI 1 Configuration) Command**

<Serial Interfacing> The RT command is used to set/read the behavior of the GPI1 pin (pin 10) of the OEM RF Module. The pin can be configured to enable binary programming or  $\overline{\text{RTS}}$  flow control.

AT Command: ATRT

Binary Command: 0x16 (22 decimal)

Parameter Range: 0 – 2

Parameter	Configuration
0	Disabled
1	Enable Binary Programming
2	Enable $\overline{\text{RTS}}$ Flow Control

Default Parameter Value: 0

Number of bytes returned: 1

**SB (Stop Bits) Command**

<Serial Interfacing> The SB Command is used to set/read the number of stop bits in the data packet.

AT Command: ATSB

Binary Command: 0x37 (55 decimal)

Parameter Range: 0 – 1

Parameter	Configuration
0	1 stop bit
1	2 stop bits

Default Parameter Value: 0

Number of bytes returned: 1

**SH (Serial Number High) Command**

<Diagnostics> SH Command is used to set/read the serial number high word of the RF module.

AT Command: ATSH

Binary Command: 0x25 (37 decimal)

Parameter Range (read-only): 0 – 0xFFFF

Default Parameter Value: varies

Number of bytes returned: 2

Related Commands: SL (Serial Number Low)

**SL (Serial Number Low) Command**

<Diagnostics> SL Command is used to set/read the serial number low word of the RF module.

AT Command: ATSL

Binary Command: 0x26 (38 decimal)

Parameter Range (read-only): 0 – 0xFFFF

Default Parameter Value: varies

Number of bytes returned: 2

Related Commands: SH (Serial Number High)

**SM (Sleep Mode) Command**

<Sleep Mode (Low Power)> The SM Command is used to set/read the RF module's Sleep Mode settings that configure the module to run in states that require minimal power consumption.

For more information regarding Sleep Modes, refer to the Sleep Mode sections [p15]

AT Command: ATSM

Binary Command: 0x01

Parameter Range: 0 – 8 (3 is reserved)

Parameter	Configuration
0	Disabled
1	Pin Sleep
2	Serial Port Sleep
3	[reserved]
4	Cyclic 1.0 second sleep (RF module wakes every 1.0 seconds)
5	Cyclic 2.0 second sleep
6	Cyclic 4.0 second sleep
7	Cyclic 8.0 second sleep
8	Cyclic 16.0 second sleep

Default Parameter Value: 0

Number of bytes returned: 1

Related Commands:

Pin Sleep – PC (Power-up Mode), PW (Pin Wake-up)

Serial Port Sleep – ST (Time before Sleep)

Cyclic Sleep – ST (Time before Sleep), LH (Wake-up Initializer Timer), HT (Time Before Wake-up Initializer), PW (Pin Wake-up)

**ST (Time before Sleep) Command**

<Sleep Mode (Low Power)> The ST Command is used to set/read the period of time (in milliseconds) in which the RF module remains inactive before entering Sleep Mode.

For example, if the ST Parameter is set to 0x64 (100 decimal), the module will enter into Sleep mode after 10 seconds of inactivity (no transmitting or receiving).

This command can only be used if Cyclic Sleep or Serial Port Sleep Mode settings have been selected using SM (Sleep Mode) Command.

AT Command: ATST

Binary Command: 0x02 (2 decimal)

Parameter Range: (ATAT+3) – 0x7FFF  
[x 100 milliseconds]

Default Parameter Value: 0x64 (100 decimal)

Number of bytes returned: 2

Related Commands: SM (Sleep Mode), LH (Wake-up Initializer Timer), HT (Time before Wake-up Initializer)

**TP (Board Temperature) Command**

<Diagnostics> TP Command is used to read the current temperature of the board.

Sample Output: 26 C [when ATCF = 0]  
1A [when ATCF = 1]  
26 [when ATCF = 2].

AT Command: ATTP

Binary Command: 0x38 (56 decimal)

Parameter Range (read-only): 0– 0x7F

Number of bytes returned: 1

Related Command: WN (Warning Data)

**TR (Transmit Error Count) Command**

<Diagnostics> The TR command is used to report the number of retransmit failures. This number is incremented each time a packet is not acknowledged within the number of retransmits specified by the RR (Retries) parameter. The number of packets therefore are counted that were not successfully received and subsequently discarded.

The TR parameter is not non-volatile and is reset to zero when the RF module is reset.

AT Command: ATTR

Binary Command: 0x1B (27 decimal)

Parameter Range: 0 – 0xFFFF

Default Parameter Value: 0

Number of bytes returned: 2

Related Commands: RR (Retries)

**TT (Streaming Limit) Command**

<Networking & Security> The TT command is used to set/read the limit on the number of bytes that can be sent out before a random delay is issued.

If an RF module is sending a continuous stream of RF data, a delay is inserted which stops its transmission and allows other modules time to transmit (once it sends TT bytes of data). Inserted random delay lasts between 1 & 'RN + 1' delay slots, where each delay slot lasts 38 ms.

The TT command can be used to simulate full-duplex behavior.

AT Command: ATTT

Binary Command: 0x1A (26 decimal)

Parameter Range: 0 – 0xFFFF

Default Parameter Value: 0 (disabled)

Number of bytes returned: 2

Related Commands: RN (Delay Slots)

**TX (Transmit Only) Command**

<RF Interfacing> The TX command is used to set/read the transmit/receive behaviors of the RF module. Setting a module to TX-only (TX = 1) may reduce latency because the transmitting module will never be confined to receiving data from other modules.

AT Command: ATTX

Binary Command: 0x3F (63 decimal)

Parameter Range: 0 – 1

Parameter	Configuration
0	TX & RX
1	TX-only

Default Parameter Value: 0

Number of bytes returned: 1

**VL (Firmware Version - Verbose)**

<Diagnostics> The VL command is used to read the verbose firmware version of the RF module.

AT Command: ATVL

Parameter Range: returns string

Default Parameter Value: 0

Number of bytes returned: 2

**VR (Firmware Version - Short) Command**

<Diagnostics> The VR command is used to read the firmware version of the RF module.

Note: Firmware versions contain four significant digits - "A.B.C.D". If B=2, the module is programmed for operation in Australia only.

AT Command: ATVR

Binary Command: 0x14 (20 decimal)

Parameter Range (read-only): 0 – 0xFFFF

Number of bytes returned: 2

**WA (Active Warning Numbers) Command**

<Diagnostics> The WA command reports the warning numbers of all active warnings - one warning number per line. No further information is shown and warning counts are not reset.

AT Command: ATWA

Parameter Range: Returns string – one warning number per line.

Sample Output (indicates warnings 1 and 3 are currently active):

```
1
3
OK
```

**WN (Warning Data) Command**

<Diagnostics> WN command is used to report the following data for all active and sticky warnings:

AT Command: ATWN

Parameter Range: returns string

- Warning number & description
- Number of occurrences since the last WN or WS command
- Whether the warning is currently active

Warnings, which are not currently active and have not been active since the last issuance of the WN or WS commands, are not displayed. The WN command also resets all non-zero warning counts; except for warnings that are presently active, which are set to 1.

Sample output: Warning 4: Over-temperature  
5 occurrences; presently inactive.

Warning #	Description
1	Under-voltage. This is caused if the supply voltage falls below the minimum threshold for the lowest power level (2.8 V). If/when the voltage rises above the threshold, the warning is deactivated. The module will not transmit below this voltage threshold.
2	Over-voltage. This is caused if the supply voltage exceeds 5.75 V. Transmission is not allowed while this warning is active.
3	Under-temperature. This is caused if the temperature sensed by the module is less than -40 C. The module does not artificially limit operation while this warning is active, but module functionality is not guaranteed.
4	Over-temperature. This is caused if the temperature sensed by the module is greater than 105 C. The module does not allow transmission nor reception while this warning is active. The warning is deactivated when the temperature falls to 100 C.
5	Power reduced. This is caused if the transmit power has to be reduced from the level programmed by PL Command due to insufficient supply voltage. The 1 W power level requires 4.75 V or higher; 500 mW requires 3.0 V or higher; 100 mW, 10 mW and 1 mW require 2.8 V or higher.
6	Default calibration data in flash. This is caused if the module-specific power calibration data is either not present or is invalid, or if none of the parameters have been modified from their default values. Power levels may be incorrect.
7	Default configuration parameters in flash. This is caused if user-modifiable parameters (i.e. those stored by a 'WR' command) in flash are all the compiled-in default values. This is caused if the user configuration is found to be not present or invalid at power-up and there is no custom configuration, or if no user-modifiable parameters have been modified from the compiled-in defaults. Modification of one or more parameters without the subsequent WR to commit the changes to flash will not deactivate this warning, since it reflects the status of the parameters in flash. Note that this warning does not reflect usage of the custom configuration defaults, only usage of the compiled-in defaults.
8	Default factory configuration parameters in flash. This is caused if the factory parameters in flash are all the default values. This is caused if the factory configuration is found to be not present or invalid at power-up, or if no factory parameters have been modified.

**WR (Write) Command**

<(Special)> The WR command is used to write configurable parameters to non-volatile memory (Values remain in the module's memory until overwritten by another use of WR Command).

AT Command: ATWR

Binary Command: 0x08

If changes are made without writing them to non-volatile memory, the module will revert back to previously saved parameters the next time the module is powered-on.

If the non-volatile user configuration is not correct, WR will re-attempt (up to 3x). If all three attempts fail, the command will return an ERROR alert.

**WS (Sticky Warning Numbers) Command**

<Diagnostics> The WS command reports warning numbers of all warnings active since the last use of the WS or WN command (including any warnings which are currently active). This command also resets all non-zero warning counts, except for warnings that are presently active, which are set to 1.

AT Command: ATWS

Parameter Range (read-only): 1 – 8

Number of bytes returned: 1

### 3.4. API Operation

By default, XTend RF Modules act as a serial line replacement (Transparent Operation) - all UART data received through the DI pin is queued up for RF transmission. When the module receives an RF packet, the data is sent out the DO pin with no additional information.

Inherent to Transparent Operation are the following behaviors:

- If module parameter registers are to be set or queried, a special operation is required for transitioning the module into Command Mode [refer to p17].
- In point-to-multipoint systems, the application must send extra information so that the receiving module(s) can distinguish between data coming from different remotes.

As an alternative to the default Transparent Operation, API (Application Programming Interface) Operations are available. API operation requires that communication with the module be done through a structured interface (data is communicated in frames in a defined order). The API specifies how commands, command responses and module status messages are sent and received from the module using a UART data frame.

#### 3.4.1. API Frame Specifications

Two API modes are supported and both can be enabled using the AP (API Enable) command. Use the following AP parameter values to configure the module to operate in a particular mode:

- AP = 0 (default): Transparent Operation (UART Serial line replacement)  
API modes are disabled.
- AP = 1: API Operation
- AP = 2: API Operation (with escaped characters)

Any data received prior to the start delimiter is silently discarded. If the frame is not received correctly or if the checksum fails, the data is silently discarded.

##### API Operation (AP parameter = 1)

When this API mode is enabled (AP = 1), the UART data frame structure is defined as follows:

Figure 3-01. UART Data Frame Structure:

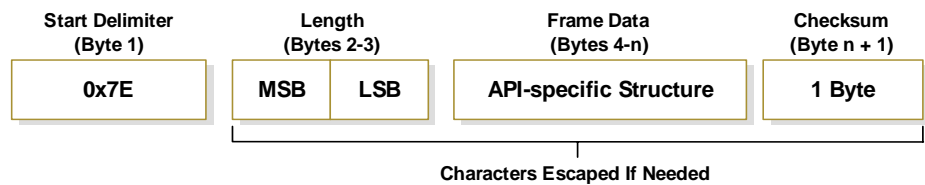


MSB = Most Significant Byte, LSB = Least Significant Byte

##### API Operation - with Escape Characters (AP parameter = 2)

When this API mode is enabled (AP = 2), the UART data frame structure is defined as follows:

Figure 3-02. UART Data Frame Structure - with escape control characters:



MSB = Most Significant Byte, LSB = Least Significant Byte

**Escape characters.** When sending or receiving a UART data frame, specific data values must be escaped (flagged) so they do not interfere with the UART or UART data frame operation. To escape an interfering data byte, insert 0x7D and follow it with the byte to be escaped XOR'd with 0x20.



**Data bytes that need to be escaped:**

- 0x7E – Frame Delimiter
- 0x7D – Escape
- 0x11 – XON
- 0x13 – XOFF

**Example - Raw UART Data Frame (before escaping interfering bytes):**  
 0x7E 0x00 0x02 0x23 0x11 0xCB  
 0x11 needs to be escaped which results in the following frame:  
 0x7E 0x00 0x02 0x23 0x7D 0x31 0xCB

Note: In the above example, the length of the raw data (excluding the checksum) is 0x0002 and the checksum of the non-escaped data (excluding frame delimiter and length) is calculated as:  
 $0xFF - (0x23 + 0x11) = (0xFF - 0x34) = 0xCB$ .

**Checksum**

To test data integrity, a checksum is calculated and verified on non-escaped data.

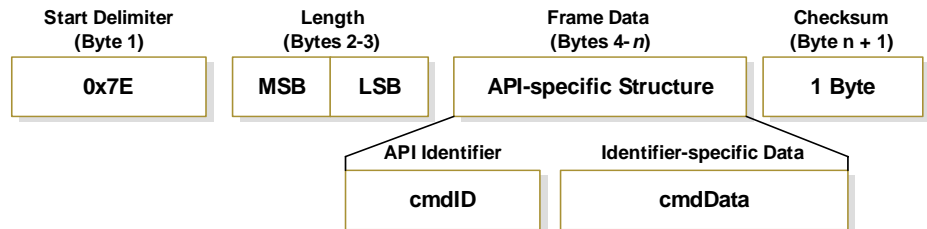
**To calculate:** Not including frame delimiters and length, add all bytes keeping only the lowest 8 bits of the result and subtract from 0xFF.

**To verify:** Add all bytes (include checksum, but not the delimiter and length). If the checksum is correct, the sum will equal 0xFF.

**3.4.2. API Types**

Frame data of the UART data frame forms an API-specific structure as follows:

Figure 3-03. UART Data Frame & API-specific Structure:



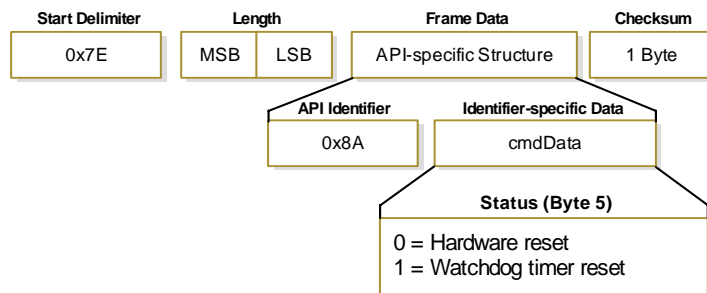
The cmdID frame (API-identifier) indicates which API messages will be contained in the cmdData frame (Identifier-specific data). Refer to the sections that follow for more information regarding the supported API types. Note that multi-byte values are sent big endian.

**RF Module Status**

**API Identifier: 0x8A**

RF module status messages are sent from the module in response to specific conditions.

Figure 3-04. RF Module Status Frames

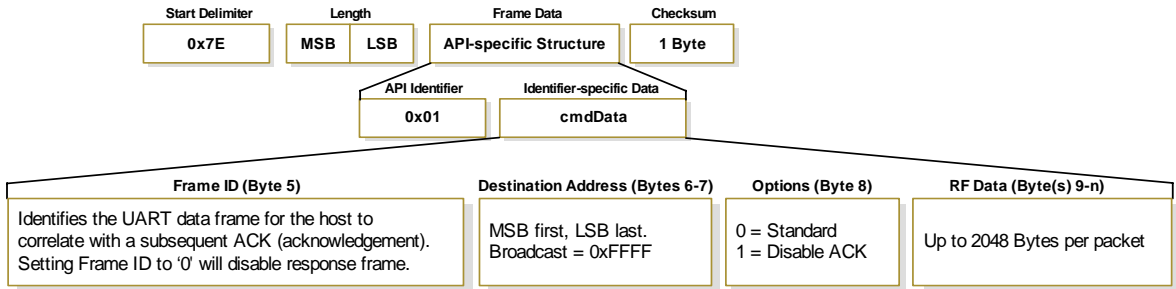


**TX (Transmit) Request: 16-bit address**

**API Identifier Value: 0x01**

A TX Request message will cause the module to send RF Data as an RF Packet.

**Figure 3-5. TX Packet (16-bit address) Frames**



**Figure 3-6. Example: TX Packet API Frames**



\* Length [Bytes] = API Identifier + Frame ID + Destination Address + Option + RF Data

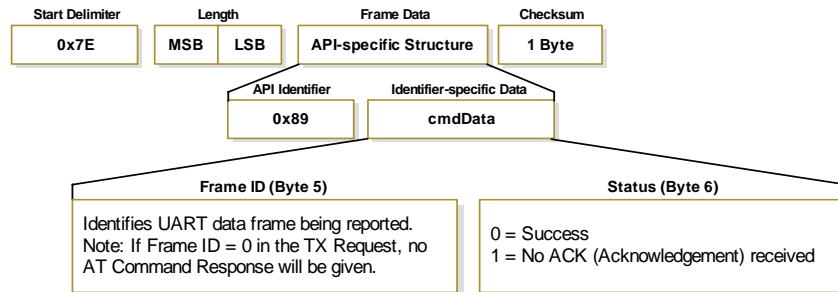
\*\* "R" value was arbitrarily selected

**TX (Transmit) Status**

**API Identifier Value: 0x89**

When a TX Request is completed, the module sends a TX Status message. This message will indicate if the packet was transmitted successfully or if there was a failure.

**Figure 3-7. TX Status Frames**



NOTE: "STATUS = 1" occurs when all retries are expired and no ACK is received.

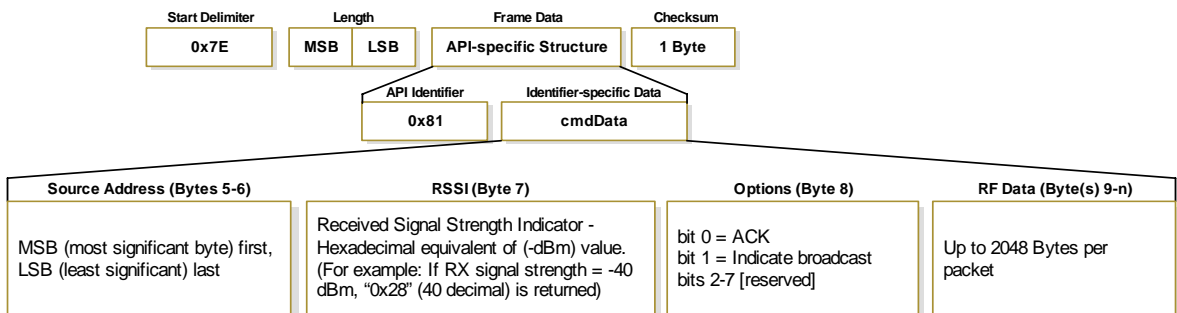
"STATUS = 3" occurs when a packet is purged due to a 'Polled Remote' not receiving a poll.

**RX (Receive) Packet: 16-bit address**

**API Identifier Value: 0x81**

When the module receives an RF packet, it is sent out the UART using this message type.

**Figure 3-8. RX Packet (16-bit address) Frames**




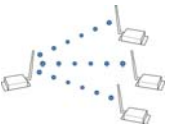
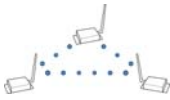
# 4. RF Communication Modes

The network configurations covered in this chapter are described in terms of the following:

- Network Topology (Point-to-Point, Point-to-Multipoint or Peer-to-Peer)
- RF Communication Type (Basic or Acknowledged)
- RF Mode (Streaming, Multi-Transmit, Repeater, Acknowledged or Polling)

The following table provides a summary of the network configurations supported.

**Table 4-01. Summary of network topologies supported by the XTend OEM RF Module**

Point-to-Point			
	Definition	An RF data link between two modules.	
	Sample Network Profile * (Broadcast Communications)	Use default values for all modules.	
	Sample Network Profile * (Acknowledged Communications)	All modules: ATAM [auto-set MY (Source Address) parameter] ** ATDT FFFF [set Destination Address to 0xFFFF]	
	Basic RF Modes	Streaming, Multi-Transmit, Repeater	
	Acknowledged RF Mode	Acknowledged Mode	
Point-to-Multipoint			
	Definition	RF data links between one base and multiple remotes.	
	Sample Network Profile * (Basic Communications)	Base:	ATMY 0 [set Source Address to 0x00] ATDT FFFF [set Destination Address to 0xFFFF]
		Remotes:	ATAM [auto-set MY (Source Address) parameter] ** ATDT 0 [set Destination Address to 0x00]
	Sample Network Profile * (Acknowledged Communications)	Base:	ATMY 0 [set Source Address to 0x00] ATDT FFFF [set Destination Address to 0xFFFF] ATRR 3 [set number of Retries to 3]
		Remotes:	ATAM [auto-set MY (Source Address) parameter] ** ATDT 0 [set Destination Address to 0x00] ATRR 3 [set number of Retries to 3]
	Basic RF Modes	Streaming, Multi-Transmit, Repeater, Polling	
Acknowledged RF Modes	Acknowledged, Polling		
Peer-to-Peer			
	Definition	RF modules remain synchronized without use of master/server dependencies. Each module shares the roles of master and slave. MaxStream's peer-to-peer architecture features fast synch times (35ms to synchronize modules) and fast cold start times (50ms before transmission).	
	Sample Network Profile * (Basic Communications)	Use default values for all modules.	
	Sample Network Profile * (Acknowledged Communications)	All modules: ATAM [auto-set MY (Source Address) parameter] ** ATDT FFFF [set Destination Address to 0xFFFF] ATRR 3 [set number of Retries to 3]	
	Basic RF Mode	Streaming	
	Acknowledged RF Mode	Acknowledged	

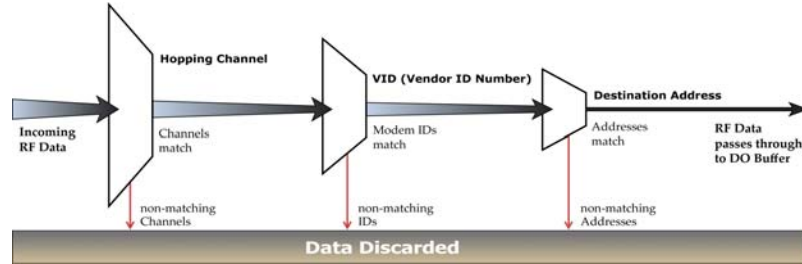
\* Assume default values for parameters not listed. Profiles do not reflect addressing implementations.

\*\* AM (Auto-set MY) Command must be issued through a terminal program such as the one incorporated in the X-CTU 'Terminal' tab.

## 4.1. Addressing

Each RF packet contains addressing information that is used to filter incoming RF data. Receiving modules inspect the Hopping Channel (HP parameter), Vendor Identification Number (ID parameter) and Destination Address (DT parameter) contained in each RF packet. Data that does not pass through all three network security layers is discarded.

Figure 4-01. Addressing layers contained in the RF packet header

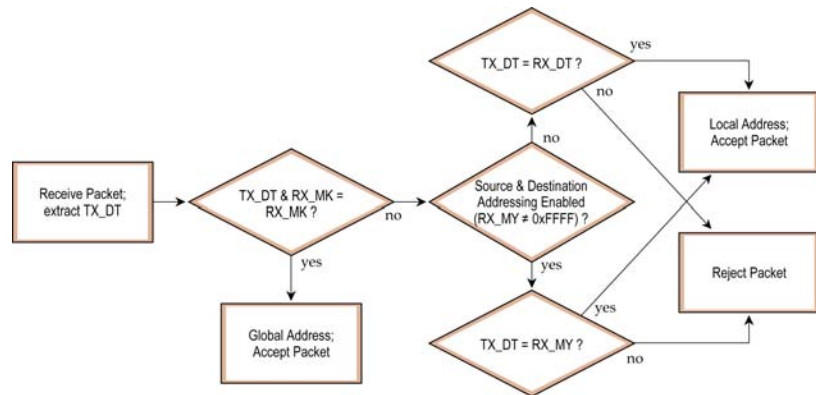


### 4.1.1. Address Recognition

Transmissions can be addressed to a specific module or group of modules using the DT (Destination Address) and MK (Address Mask) commands. A receiving module will only accept a packet if it determines the packet is addressed to it, either as a global or local packet. The receiving module makes this determination by inspecting the destination address of the packet and comparing it to its own address and address mask [refer to the figure below].

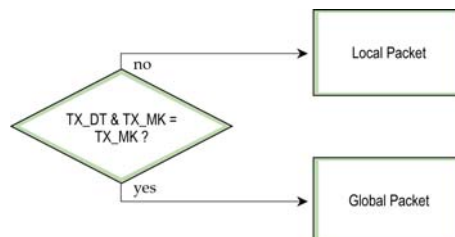
Figure 4-02. Address Recognition (@ the Receiving RF Module)

TX\_DT = Destination Address of transmitting module  
 RX\_DT = Destination Address of receiving module  
 RX\_MK = Address Mask of receiving module  
 RX\_MY = Source Address of receiving module



The transmitting module determines whether the packet is intended for a specific node (local address) or multiple nodes (global address) by comparing the packet's destination address (DT) and its own address mask (MK) [refer to the figure below]. It is assumed that the address masks on the transmitting module and receiving module have been programmed to the same value for proper operation in each RF Communication Mode.

Figure 4-03. Address Recognition (@ the Transmitting RF Module)



## 4.2. Basic Communications

Basic Communications are accomplished through two sub-types:

- Broadcast - By default, XTend RF Modules communicate through Broadcast communications and within a peer-to-peer network topology. When any module transmits, all other modules within range will receive the data and pass it directly to their host device.
- Addressed - If addressing parameters match are in order, received RF data is forwarded to the DO (Data Out) buffer; otherwise, the RF data is discarded.

When using Basic Communications, any functions such as acknowledgements are handled at the application layer by the OEM/integrator. The Broadcast Modes provide transparent communications, meaning that the RF link simply replaces a wired link.

### 4.2.1. Streaming Mode (Default)

**Characteristics:** Highest data throughput

Lowest latency and jitter

Reduced immunity to interference

Transmissions never acknowledged (ACK) by receiving module(s)

**Required Parameter Values (TX module):** RR (Retries) = 0

**Related Commands:** Networking (DT, MK, MY), Serial Interfacing (PK, RB, RO, TT)

**Recommended Use:** Mode is most appropriate for data systems more sensitive to latency and/or jitter than to occasional packet loss. For example: streaming audio or video.

#### Connection Sequence

**Figure 4-04. Streaming Mode State Diagram (TX Module)**

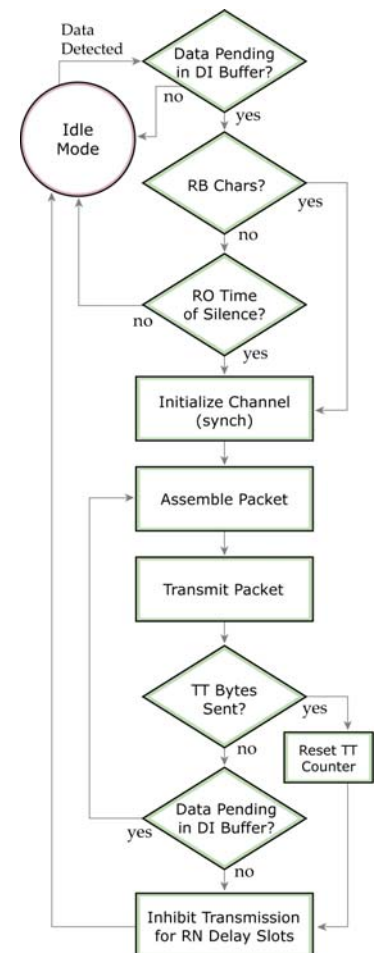
- Events & processes in this mode are common to all of the other RF Modes.
- When streaming data, RB and RO parameters are only observed on the first packet.

After transmission begins, the transmission event will continue uninterrupted until the DI buffer is empty or the streaming limit (TT parameter) is reached. As with the first packet, the payload of each subsequent packet includes up to the maximum packet size (PK parameter).

The TT parameter (streaming limit) is specified by the TX (transmitting) module as the maximum number of bytes the TX module can send in one transmission event. After the TT parameter threshold is reached, the TX module will force a random delay of 1 to RN delay slots (exactly 1 delay slot if RN = 0).

Subsequent packets are sent without an RF initializer since RX (receiving) modules remain synchronized with the TX module for the duration of the transmission (from preceding packet information). However, due to interference, some RX modules may lose data (and synchronization to the TX module), particularly during long transmission events.

Once the TX module has sent all pending data or has reached the TT limit, the transmission event ends. The TX module will not transmit again for exactly RN delay slots if the local (i.e. TX module's) RN parameter is set to a non-zero value. The RX module(s) will not transmit for a random number of delay slots between 0 and (RN-1) if the local (i.e. receiving module's) RN parameter is set to a non-zero value. These delays are intended to lessen congestion following long bursts of packets from a single TX module, during which several RX modules may have become ready to transmit.



### 4.2.2. Multi-transmit Mode

**Attributes:** Reliable Delivery through forced transmission of every RF packet  
 Every RF packet is sent exactly (MT + 1) times with no delays between packets  
 Diminished throughput and increased latency

**Required Parameter Values (TX module):** MT (Multi-Transmit) >= 1

**Other Related Commands:** Networking (DT, MK, MY, RN, TT), Serial Interfacing (BR, PK, RB, RO), RF Interfacing (FS)

**Recommended Use:** Use for applications that require Reliable Delivery without using retries and acknowledgements.

#### Connection Sequence

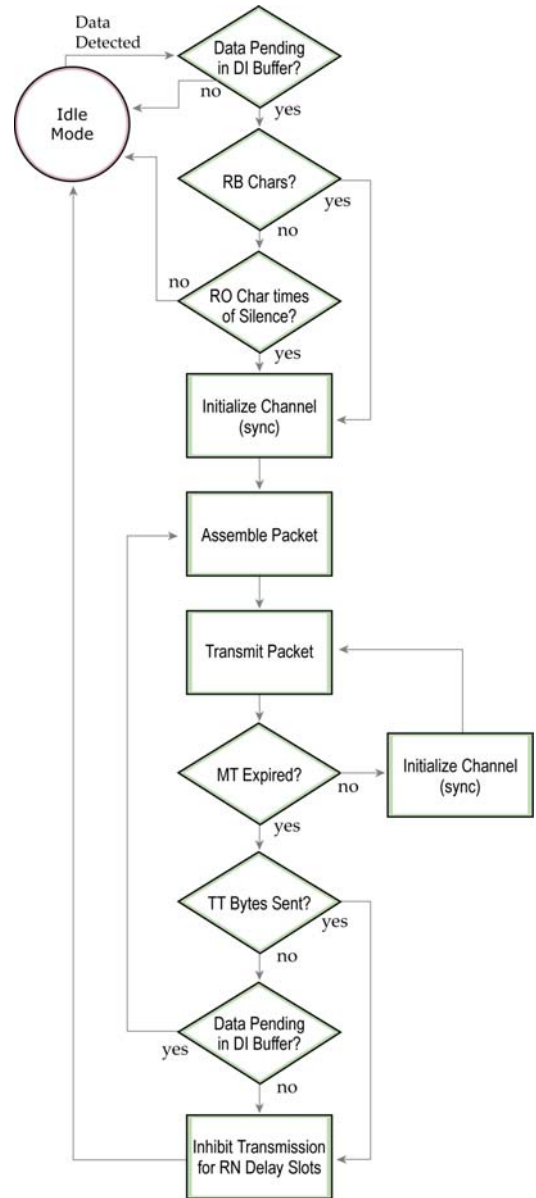
**Figure 4-05. Multi-Transmit Mode State Diagram (TX Module)**

In Multi-Transmit Mode, each packet is retransmitted MT times, for a total of (MT+1) transmissions. There is no delay between retransmissions, and the TX (transmitting) module will never receive RF data between retransmissions. Each retransmission includes an RF initializer. A transmission event may include follow-on packets, each of which will be retransmitted MT times. The Forced Sync (FS) parameter is ignored in Multi-Transmit Mode.

The RB and RO parameters are not applied to follow-on packets, meaning that once transmission has begun, it will continue uninterrupted until the DI buffer is empty or the streaming limit (TT parameter) has been reached. As with the first packet, the payload of each follow-on packet includes up to the maximum packet size (PK parameter) bytes, and the TX module checks for more pending data near the end of each packet. Follow-on packets are not sent until all retransmissions of the previous packet are finished.

The streaming limit (TT) is specified at the TX module as the maximum number of bytes that the TX module can send in one transmission event, which may consist of many packets. If the TT parameter is reached, the TX module will force a random delay of 1 to RN delay slots (exactly 1 delay slot if RN is zero). In Multi-Transmit Mode, each packet is counted only once when tracking the streaming limit (TT), no matter how many times it is retransmitted.

When an RX (receiving) module receives a Multi-Transmit packet, it calculates the amount of time remaining in the Multi-Transmit event, and inhibits its own transmissions for the duration of the Multi-Transmit event, plus a random number of delay slots between 0 and (RN-1). If the local RN parameter is zero, the delay is only for the calculated duration of the Multi-Transmit event. Thus, an RX module need only receive one of the transmissions, and it will keep off the channel until the TX module is done. If follow-on packets are coming, the RX modules will move to the new frequency and listen for the follow-on packet for a specific period of time.



### 4.2.3. Repeater Mode

- Attributes:** Low power consumption  
 Minimized interference  
 Each RF packet is tagged with a unique Packet ID (PID).  
 Each repeater will repeat a packet only once (tracked by the PID).  
 Increased latency and decreased throughput  
 (Latency and throughput is determined by number of hops, not by number of repeaters. Multiple repeaters within range of source node count as one hop.)  
 All RF packets propagate to every module in the network (filtering rules apply).  
 Packet destination addresses (DT) determine which packets are sent out serial port and/or retransmitted.  
 Broadcast communications - each packet comes out every node exactly once.  
 Addressed communications - all modules see every packet. Only the module with a matching address will forward it to the DO buffer (UART IN).
- Constraints:** Requires that each module have a unique MY (Source Address) parameter.  
 System must introduce just one packet at a time to the network for transmission (Maximum number of bytes is determined by the PK parameter).  
 Each hop (H) decreases network throughput by a factor of  $1/(H+1)$ . Additional repeaters add network redundancy without decreasing throughput.
- Suggestions:** Insert a variable delay before repeating packets to avoid collisions (based on RSSI).  
 Buffer any incoming serial data and delay response packet transmissions until previous packet has cleared out of network.  
 For best results, use the RO and RB commands to ensure that the RF packets align with the underlying protocol packets as the network can only accept one RF packet at a time.

**Required Parameter Values (TX module):** MD = 5 or 6, MY = unique value (can be accomplished by issuing the AM (Auto-set MY) and WR (Write) commands to all modules in the network)

**Related Commands:** Networking (MD, DT, MY, AM), Serial Interfacing (RN, PK, RO, RB)

**Recommended Use:** Use in networks where intermediary modules are needed to relay data to modules beyond the transmission range of the base module.

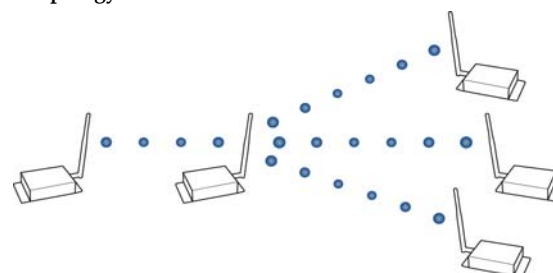
#### Theory of Operation

OEMs and integrators can extend the effective range and reliability of their data radio system by forwarding traffic through one or more repeaters. Instead of using routing tables and path discovery to establish dynamic paths through a network, the repeater system uses a sophisticated algorithm to propagate each RF packet through the entire network.

The network supports RF packets up to 2048 bytes (when the RF data rate is set at 9600 bps (BR = 0)). The repeater network can operate using broadcast or addressed communications for multi-drop networks and works well in many systems with no special configuration.

When in Repeater Mode, the network repeats each message among all available modules exactly one time. This mechanism eliminates the need for configuring specific routes.

**Figure 4-06. Repeater Network Topology**



**Repeater Network Configuration**

A network may consist of End Nodes (EN), End/Repeater Nodes (ERN) and a Base Node (BN). The base node initiates all communications.

A repeater network can be configured to operate using Basic Broadcast or Basic Addressed communications. The addressing capabilities of the module allow integrators to send a packet as a global packet (DT = 0xFFFF) and shift out of every module in the network (Basic Broadcast). Alternatively, the packet can be sent with a specific DT (Destination Address) parameter so that it is only accepted by a specific remote node (Basic Addressed).

**Configuration Instruction (Basic Broadcast Communications)**

Assign each module a unique MY (source) address. (The AM (Auto-set MY) command will configure a unique source address that is based on module serial number.)  
 Enable Basic Broadcast Communications (DT = 0xFFFF) or Addressed Broadcast Communications (DT specifies a specific destination)  
 Configure PK, RO and RB to ensure that RF packet aligns with protocol packet. (ex. PK=0x100, RB=0x100, RO depends on baud rate).  
 Configure one or more repeaters in the system (MD = 5).  
 Configure remote nodes as destinations (MD = 6). This will ensure that the remote node waits for the repeater traffic to subside before it transmits a response.

The configuration instructions above reflect configuration for a Basic Broadcast Repeater system. To configure a Basic Addressed Repeater system, use the DT (Destination Address) parameter to assign unique addresses to each module in the network.

**Algorithm Details**

- Packet ID (PID) is composed of TX (transmitting) module MY address and packet sequence number.
- Incoming packets with a PID already found in the PID buffer will be ignored.
- Each module maintains a PID buffer 4 deep of previously received packets (managed as FIFO).

Packets may be shifted out the serial port and/or repeated depending on the DT parameter contained in the RF packet.

**Table 4-02. DT (Destination Address) parameter truth table**

Address Match	Send out serial port?	Repeat?
Global	Yes	Yes
Local	Yes	No
None	No	Yes

**Repeat Delay Based on RSSI**

A transmitted packet may be received by more than one repeater at the same time. In order to reduce the probability that the repeaters will transmit at the same instant, resulting in a collision and possible data loss; an algorithm has been developed that will allow a variable back-off prior to retransmission of the packet by a repeater. The algorithm allows radios that receive the packet with a stronger RF signal (RSSI) to have the first opportunity to retransmit the packet.

The RN (Delay Slots) parameter is used to configure this delay. Set RN=0 (no delays) for small networks with few repeaters or repeaters that are not within range of each other. Set RN=1 for systems with 2 to 5 repeaters that may be within range of each other.

The actual length of the delay is computed by the formula:

$$\text{Delay (ms)} = L * \text{DS}$$

$$\text{DS} = (-41 - \text{RSSI}) / 10 * \text{RN} + \text{RandomInt}(0, \text{RN})$$

Where L is the length of the transmitted packet in milliseconds, DS is the number of delay slots to wait, RSSI is the received signal strength in dBm, RN is the value of the RN register and RandomInt(A,B) is a function that returns a random integer from A to B-0



### Response Packet Delay

As a packet propagates through the repeater network, if any node receives the data and generates a quick response, the response needs to be delayed so as not to collide with subsequent retransmissions of the original packet. To reduce collisions, both repeater and end node radios in a repeater network will delay transmission of data shifted in the serial port to allow any repeaters within range to complete their retransmissions.

The time for this delay is computed by the formula:

$$\text{Maximum Delay (ms)} = L * DS$$

$$DS = ((-41 - (-100)) / 10) * RN + RN + 1$$

Where L is the length of the transmitted packet in milliseconds, DS is the number of delay slots to wait, RSSI is the received signal strength in dBm, and RN is the value of the RN register.

### Use Case - Broadcast Repeater Network

Consider modules R1 through R10 each communicating to a PLC using the ModBus protocol and spaced evenly in a line. All ten modules are configured as 'destinations & repeaters' within the scope of Basic Broadcast Communications (MD=5, AM, DT=0xFFFF, PK=0x100, RO=0x03, RB=0x100, RN=1). The Base Host (BH) shifts payload that is destined for R10 to R1. R1 initializes RF communication and transmits payload to nodes R2 through R5 which are all within range of R1. The modules R2 through R5 receive the RF packet and retransmit the packet simultaneously. They also send the data out the serial ports, to the PLCs.

**Table 4-03. Commands used to configure repeater functions**

AT Command	Binary Command	AT Command Name	Range	# Bytes Returned	Factory Default
AM	0x3A (58d)	Auto-set MY	-	-	-
DT	0x00 (0d)	Destination Address	0 - 0xFFFF	2	0
MD	0x3C (60d)	RF Mode	0 - 6	1	0
MY	0x2A (42d)	Source Address	0 - 0xFFFF	2	0xFFFF
RN	0x19 (25d)	Delay Slots	0 - 0xFF [slots]	1	0
WR	0x08 (8d)	Write	-	-	-

### Bandwidth Considerations

Using broadcast repeaters in a network reduces the overall network data throughput as each repeater must buffer an entire packet before retransmitting it. For example: if the destination is within range of the transmitter and the packet is 32-bytes long, the transmission will take 12ms on an XTend module operating at 115,200 baud. If the same packet must propagate through two repeaters, it will take 12ms to arrive at the first repeater, 12ms to get to the second and a final 12ms to reach the destination for a total of 36ms. Taking into account UART transfer times (~1ms/byte at 9600 baud), a server to send a 32-byte query and receive a 32-byte response is about 200ms, allowing for 5 polls per second. With the two repeaters in the path, the same query/response sequence would take about 500ms for 2 polls per second.

Generally, network throughput will decrease by a factor of 1/(R+1), with R representing the number of repeaters between the source and destination.

#### 4.2.4. Polling Mode (Basic)

NOTE: Polling Mode (Basic) and Polling Mode (Acknowledged) [p53] operate in the same way. The only difference between the two modes is in their means of achieving reliable delivery of data. In Polling Mode (Basic), reliable delivery is achieved using multiple transmissions.

**Attributes:**

- Utilizes high percentage of available network bandwidth
- Eliminates collisions
- Works with reliable delivery (RR or MT parameters)
- Supports binary data transfers
- Base module requests packets from remote module by polling a sequential range of addresses
- Base module is configured to specify the range of addresses being polled
- Uses inter-character delay to create RF packet lengths aligned with protocol packet lengths up to 2048 bytes long.

**Required Parameter Values (Base):** MD (RF Mode) = 3, PB (Polling Begin Address), PE (Polling End Address)

**Required Parameter Value (Remote):** MD (RF Mode) = 4

**Related Commands:** Networking (MT, PD, DT, MY, AM)

**Constraints:** The minimum time interval between polling cycles is configurable. However, if the remote modules cannot all be processed within that time interval, the polling cycle is ineffective (i.e. it will impose no additional delay). In order to ensure a pause between polling cycles, PD must be set to a value which is large enough to accommodate the pause.

**Recommended Use:** Use for point-to-multipoint applications that require Reliable Delivery of data. Use this mode when it is critical that a base module be able to discern data coming from multiple modules.

#### Theory of Operation

A 'Polling Base' module will cycle through a sequential range of addresses. The 'Polling Base' will poll each 'Polling Remote' module, wait for a response, then poll the next remote address in the sequence. Each 'Polling Remote' will respond by sending the data from its DI (Data In) buffer following the RB (Packetization Threshold) & RO (Packetization Timeout) parameters. When there is no eligible data to send, the 'Polling Remote' will not respond. The 'Polling Base' will poll the next address in the polling sequence after a short delay.

##### Polling Base Configuration:

Set the MD (RF Mode) parameter (MD = 3).  
 Set MY (Source Address) parameter (MY = 0).  
 Set the sequential range of Polling Addresses using the PB (Polling Begin Address) and PE (Polling End Address) parameters.  
 (Optional) Enable Basic Reliable Delivery (MT >= 0). Note: Acknowledged Reliable Delivery is also supported. Refer to the 'Polling Mode - Acknowledged' section for more information.  
 (Optional) Use the PD (Minimum Polling Delay) command to configure a delay between polls to slow down system (if needed).  
 (Optional) Enable API Mode to address remotes within polling range on a packet-by-packet basis.

##### Polling Remote Configuration:

Set the MD (RF Mode) parameter (MD = 4).  
 Configure sequential source addresses for all remote modules using the MY (Source Address) command.  
 Set the DT (Destination Address) parameter to point to 'Polling Base' (DT = 0x0000).  
 (Optional) Enable Basic Reliable Delivery (MT >= 0). Note: Acknowledged Reliable Delivery is also supported. Refer to the 'Polling Mode - Acknowledged' section for more information.

### 4.3. Acknowledged Communications

#### 4.3.1. Acknowledged Mode

**Attributes:** Reliable delivery through positive acknowledgements for each packet  
Throughput, latency and jitter vary depending on the quality of the channel and the strength of the signal.

**Required Parameter Values (TX module):** RR (Retries) >= 1

**Related Commands:** Networking (DT, MK, RR), Serial Interfacing (PK, RN, RO, RB, TT)

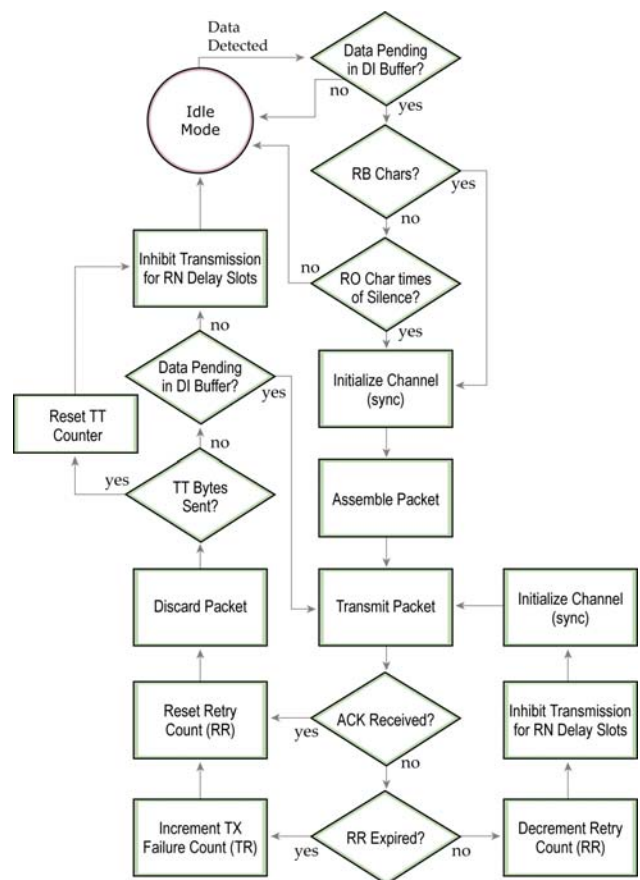
**Recommended Use:** Use for applications that require Reliable Delivery. If messages are smaller than 256 bytes, use RB and RO commands to align RF packets to application packets.

#### Connection Sequence

**Figure 4-07. Acknowledged Mode State Diagram (TX module)**

After sending a packet while in Acknowledged Mode, the TX (transmitting) module listens for an ACK (acknowledgement). If it receives the ACK, it will either move on to sending a subsequent packet (if more transmit data is pending) or will wait for exactly RN random delay slots before allowing another transmission (if no more data is pending to be transmitted).

If the TX module does not receive the ACK within the allotted time, it will retransmit the packet with a new RF initializer following the ACK slot. There is no delay between the first ACK slot and the first retransmission. Subsequent retransmissions incur a delay of a random number of delay slots, between 0 and RN. If RN is set to 0 on the TX module, there are never any back-off delays between retransmissions. Note that during back-off delays, the TX module will go into Idle Mode and may receive RF data. This can have the effect of increasing the back-off delay, as the module cannot return to Transmit (or retransmit) Mode as long as it is receiving RF data.



After receiving and acknowledging a packet, the RX (receiving) module will move to the next frequency and listen for either a retransmission or new data for a specific period of time. Even if the TX module has indicated that it has no more pending transmit data, it may not have received the previous ACK, and so may retransmit the packet, possibly with no delay after the ACK slot. In this case, the RX module will always detect the immediate retransmission, which will hold off the communications channel and thereby reduce collisions. RX modules acknowledge each retransmission they receive, but they only pass the first copy of a packet they receive out the UART.

RB and RO parameters are not applied to subsequent packets, meaning that once transmission has begun, it will continue uninterrupted until the DI buffer is empty or the streaming limit (TT parameter) has been reached. As with the first packet, the payload of each subsequent packet includes up to the maximum packet size (PK parameter), and the TX module checks for more pending data near the end of each packet.

The TT parameter (streaming limit) specifies the maximum number of bytes that the TX module will send in one transmission event, which may consist of many packets and retries. If the TT parameter is reached, the TX module will force a random delay of 1 to RN delay slots (exactly 1 delay slot if RN is zero). Each packet is counted only once toward TT, no matter how many times the packet is retransmitted.

Subsequent packets in Acknowledged Mode are similar to those in Streaming Mode, with the addition of an ACK between each packet, and the possibility of retransmissions. Subsequent packets are sent without an RF initializer, as the RX modules are already synchronized to the TX module from the preceding packet(s) and they remain synchronized for the duration of the transmission event. Each retransmission of a packet includes an RF initializer.

Once the TX module has sent all pending data or has reached the TT limit, the acknowledged transmission event is completed. The TX module will not transmit again for exactly RN delay slots, if the local RN parameter is set to a non-zero value. The RX module will not transmit for a random number of delay slots between 0 and (RN-1), if the local RN parameter is set to a non-zero value. These delays are intended to lessen congestion following long bursts of packets from a single TX module, during which several RX modules may have themselves become ready to transmit.

### 4.3.2. Polling Mode (Acknowledged)

NOTE: Polling Mode (Acknowledged) and Polling Mode (Basic) [p50] operate in the same way. The difference between the two modes is in their means of achieving reliable delivery of data. In Polling Mode (Acknowledged), reliable delivery is achieved using retries and acknowledgements.

**Attributes:**

- Utilizes high percentage of available network bandwidth
- Eliminates collisions
- Works with reliable delivery (RR or MT parameters)
- Supports binary data transfers
- Base module requests packets from remote module by polling a sequential range of addresses
- Base module is configured to specify the range of addresses being polled
- Uses inter-character delay to create RF packet lengths aligned with protocol packet lengths up to 2048 bytes long.

**Required Parameter Values (Base):** MD (RF Mode) = 3, PB (Polling Begin Address), PE (Polling End Address)

**Required Parameter Values (Remote):** MD (RF Mode) = 4

**Related Commands:** Networking (RR, PD, DT, MY, AM)

**Constraints:** The minimum time interval between polling cycles is configurable. However, if the remote modules cannot all be processed within that time interval, the polling cycle is ineffective (i.e. it will impose no additional delay). In order to ensure a pause between polling cycles, PD must be set to a value which is large enough to accommodate the pause.

**Recommended Use:** Use for point-to-multipoint applications that require Reliable Delivery of data. Use this mode when it is critical that a base module be able to discern data coming from multiple modules.

#### Theory of Operation

A 'Polling Base' module will cycle through a sequential range of addresses. The 'Polling Base' will poll each 'Polling Remote' module, wait for a response, then poll the next remote address in the sequence. Each 'Polling Remote' will respond by sending the data from its DI (Data In) buffer following the RB (Packetization Threshold) & RO (Packetization Timeout) parameters. When there is no eligible data to send, the 'Polling Remote' will not respond. The 'Polling Base' will poll the next address in the polling sequence after a short delay.

#### Polling Base Configuration:

Set the MD (RF Mode) parameter (MD = 3).

Set MY (Source Address) parameter (MY = 0).

Set the sequential range of Polling Addresses using the PB (Polling Begin Address) and PE (Polling End Address) parameters.

(Optional) Enable Acknowledged Reliable Delivery (RR >= 0). Note: Basic Reliable Delivery is also supported. Refer to the 'Polling Mode - Basic section for more information.

(Optional) Use the PD (Minimum Polling Delay) command to configure a delay between polls to slow down system (if needed).

(Optional) Enable API Mode to address remotes within polling range on a packet-by-packet basis.

#### Polling Remote Configuration:

Set the MD (RF Mode) parameter (MD = 4).

Configure sequential source addresses for all remote modules using the MY (Source Address) command.

Set the DT (Destination Address) parameter to point to 'Polling Base' (DT = 0x0000).

(Optional) Enable Acknowledged Reliable Delivery (RR >= 0). Note: Basic Reliable Delivery is also supported. Refer to the 'Polling Mode - Basic section for more information.

# Appendix A: Agency Certifications

---

## FCC (United States) Certification

---

The XTend OEM RF Module complies with Part 15 of the FCC rules and regulations. Compliance with the labeling requirements, FCC notices and antenna usage guidelines is required.

In order to operate under MaxStream's FCC Certification, OEMs/integrators must comply with the following regulations:

1. The OEM/integrator must ensure that the text provided with this device [Figure A-01] is placed on the outside of the final product and within the final product operation manual.
2. The XTend OEM RF Module may only be used with antennas that have been tested and approved for use with this module [refer to 'FCC-approved Antennas' section].

## OEM Labeling Requirements

---



**WARNING:** The Original Equipment Manufacturer (OEM) must ensure that FCC labeling requirements are met. This includes a clearly visible label on the outside of the final product enclosure that displays the text shown in the figure below.

**Figure A-01. Required FCC Label for OEM products containing the XTend OEM RF Module**

Contains FCC ID: OUR-9XTEND

The enclosed device complies with Part 15 of the FCC Rules. Operation is subject to the following two conditions: (i.) this device may not cause harmful interference and (ii.) this device must accept any interference received, including interference that may cause undesired operation.

## FCC Notices

---

**IMPORTANT:** The XTend OEM RF Module has been certified by the FCC for use with other products without any further certification (as per FCC section 2.1091). Modifications not expressly approved by MaxStream could void the user's authority to operate the equipment.

**IMPORTANT:** OEMs must test final product to comply with unintentional radiators (FCC section 15.107 & 15.109) before declaring compliance of their final product to Part 15 of the FCC Rules.

**IMPORTANT:** The RF module has been certified for remote and base radio applications. If the module will be used for portable applications, the device must undergo SAR testing.

This equipment has been tested and found to comply with the limits for a Class B digital device, pursuant to Part 15 of the FCC Rules. These limits are designed to provide reasonable protection against harmful interference in a residential installation. This equipment generates, uses and can radiate radio frequency energy and, if not installed and used in accordance with the instructions, may cause harmful interference to radio communications. However, there is no guarantee that interference will not occur in a particular installation.

If this equipment does cause harmful interference to radio or television reception, which can be determined by turning the equipment off and on, the user is encouraged to try to correct the interference by one or more of the following measures: Re-orient or relocate the receiving antenna, Increase the separation between the equipment and receiver, Connect equipment and receiver to outlets on different circuits, or Consult the dealer or an experienced radio/TV technician for help.

---

## Limited Modular Approval

---

Power output is conducted at the antenna terminal and can be adjusted from 1 mill-watt to 1 Watt at the OEM level. This is an RF module approved for Limited Modular use operating as a mobile transmitting device with respect to section 2.1091 and is limited to OEM installation for Mobile and Fixed applications only. During final installation, end-users are prohibited from access to any programming parameters. Professional installation adjustment is required for setting module power and antenna gain to meet EIRP compliance for high gain antenna(s).

Final antenna installation and operating configurations of this transmitter including antenna gain and cable loss must not exceed the EIRP of the configuration used for calculating MPE. Grantee (MaxStream) must coordinate with OEM integrators to ensure the end-users and installers of products operating with the module are provided with operating instructions to satisfy RF exposure requirements.

The FCC grant is valid only when the device is sold to OEM integrators. Integrators are instructed to ensure the end-user has no manual instructions to remove, adjust or install the device.

---

## FCC-approved Antennas

---



**WARNING:** This device has been tested with Reverse Polarity SMA connectors with the antennas listed in the tables of this section. When integrated into OEM products, fixed antennas require installation preventing end-users from replacing them with non-approved antennas. Antennas not listed in the tables must be tested to comply with FCC Section 15.203 (unique antenna connectors) and Section 15.247 (emissions).

---

## Fixed Base Station and Mobile Applications

---

MaxStream RF Modules are pre-FCC approved for use in fixed base station and mobile applications. When the antenna is mounted at least 20cm (8") from nearby persons, the application is considered a mobile application.

---

## Portable Applications and SAR Testing

---

When the antenna is mounted closer than 20cm to nearby persons, then the application is considered "portable" and requires an additional test be performed on the final product. This test is called Specific Absorption Rate (SAR) testing and measures the emissions from the module and how they affect the person.

---

## RF Exposure

---

This statement must be included as a CAUTION statement in OEM product manuals.



**WARNING:** This equipment is approved only for mobile and base station transmitting devices. Antenna(s) used for this transmitter must be installed to provide a separation distance of at least 30 cm from all persons and must not be co-located or operating in conjunction with any other antenna or transmitter.

**NOTE:** The separation distance indicated in the above is 30 cm, but any distance greater than or equal to 23 cm can be used (per MPE evaluation).

**Antenna Options** (1-watt transmit power output or lower)**Table A-01. Half-wave antennas (approved when operating at 1-watt power output or lower)**

Part Number	Type	Connector	Gain	Application
A09-HSM-7	Straight half-wave	RPSMA	3.0 dBi	Fixed / Mobile
A09-HASM-675	Articulated half-wave	RPSMA	2.1 dBi	Fixed / Mobile
A09-HABMM-P6I	Articulated half-wave w/ 6" pigtail	MMCX	2.1 dBi	Fixed / Mobile
A09-HABMM-6-P6I	Articulated half-wave w/ 6" pigtail	MMCX	2.1 dBi	Fixed / Mobile
A09-HBMM-P6I	Straight half-wave w/ 6" pigtail	MMCX	2.1 dBi	Fixed / Mobile
A09-HRSM	Right angle half-wave	RPSMA	2.1 dBi	Fixed
A09-HASM-7	Articulated half-wave	RPSMA	2.1 dBi	Fixed
A09-HG	Glass mounted half-wave	RPSMA	2.1 dBi	Fixed
A09-HATM	Articulated half-wave	RPTNC	2.1 dBi	Fixed
A09-H	Half-wave dipole	RPSMA	2.1 dBi	Fixed

**Table A-02. Yagi antennas (approved when operating at 1-watt power output or lower)**

Part Number	Type	Connector	Gain	Required Antenna Cable Loss	Application
A09-Y6	2 Element Yagi	RPN	6.1 dBi	0.1 dB*	Fixed / Mobile
A09-Y7	3 Element Yagi	RPN	7.1 dBi	1.1 dB*	Fixed / Mobile
A09-Y8	4 Element Yagi	RPN	8.1 dBi	2.1 dB*	Fixed / Mobile
A09-Y6TM	2 Element Yagi	RPTNC	6.1 dBi	0.1 dB*	Fixed / Mobile
A09-Y7TM	3 Element Yagi	RPTNC	7.1 dBi	1.1 dB*	Fixed / Mobile
A09-Y8TM	4 Element Yagi	RPTNC	8.1 dBi	2.1 dB*	Fixed / Mobile

**Table A-03. Omni-directional base station antennas (approved when operating at 1-watt power output or lower)**

Part Number	Type	Connector	Gain	Required Antenna Cable Loss	Application
A09-F0	Fiberglass Base Station	RPN	0 dBi	-	Fixed
A09-F1	Fiberglass Base Station	RPN	1.0 dBi	-	Fixed
A09-F2	Fiberglass Base Station	RPN	2.1 dBi	-	Fixed
A09-F3	Fiberglass Base Station	RPN	3.1 dBi	-	Fixed
A09-F4	Fiberglass Base Station	RPN	4.1 dBi	-	Fixed
A09-F5	Fiberglass Base Station	RPN	5.1 dBi	-	Fixed
A09-F6	Fiberglass Base Station	RPN	6.1 dBi	0.1 dB*	Fixed
A09-F7	Fiberglass Base Station	RPN	7.1 dBi	1.1 dB*	Fixed
A09-F8	Fiberglass Base Station	RPN	8.1 dBi	2.1 dB*	Fixed
A09-W7	Wire Base Station	RPN	7.1 dBi	1.1 dB*	Fixed
A09-F0	Fiberglass Base Station	RPSMA	0 dBi	-	Fixed
A09-F1	Fiberglass Base Station	RPSMA	1.0 dBi	-	Fixed
A09-F2	Fiberglass Base Station	RPSMA	2.1 dBi	-	Fixed
A09-F3	Fiberglass Base Station	RPSMA	3.1 dBi	-	Fixed
A09-F4	Fiberglass Base Station	RPSMA	4.1 dBi	-	Fixed
A09-F5	Fiberglass Base Station	RPSMA	5.1 dBi	-	Fixed
A09-F6	Fiberglass Base Station	RPSMA	6.1 dBi	0.1 dB*	Fixed
A09-F7	Fiberglass Base Station	RPSMA	7.1 dBi	1.1 dB*	Fixed
A09-F8	Fiberglass Base Station	RPSMA	8.1 dBi	2.1 dB*	Fixed
A09-W7SM	Wire Base Station	RPSMA	7.1 dBi	1.1 dB*	Fixed
A09-F0TM	Fiberglass Base Station	RPTNC	0 dBi	-	Fixed
A09-F1TM	Fiberglass Base Station	RPTNC	1.0 dBi	-	Fixed
A09-F2TM	Fiberglass Base Station	RPTNC	2.1 dBi	-	Fixed
A09-F3TM	Fiberglass Base Station	RPTNC	3.1 dBi	-	Fixed
A09-F4TM	Fiberglass Base Station	RPTNC	4.1 dBi	-	Fixed
A09-F5TM	Fiberglass Base Station	RPTNC	5.1 dBi	-	Fixed
A09-F6TM	Fiberglass Base Station	RPTNC	6.1 dBi	0.1 dB*	Fixed
A09-F7TM	Fiberglass Base Station	RPTNC	7.1 dBi	1.1 dB*	Fixed
A09-F8TM	Fiberglass Base Station	RPTNC	8.1 dBi	2.1 dB*	Fixed
A09-W7TM	Wire Base Station	RPTNC	7.1 dBi	1.1 dB*	Fixed

\* FCC regulations stipulate a 36 dBm EIRP power requirement. Users implementing antenna gain greater than 6.0 dB must compensate for the added gain with cable loss. When operating at 1 W power output, the sum (in dB) of cable loss and antenna gain shall not exceed 6.0 dB.



**Table A-04. Mag Mount antennas (approved when operating at 1-watt power output or lower)**

Part Number	Type	Connector	Gain	Required Antenna Cable Loss	Application
A09-M0SM	Mag Mount	RPSMA	0 dBi	-	Fixed
A09-M2SM	Mag Mount	RPSMA	2.1 dBi	-	Fixed
A09-M3SM	Mag Mount	RPSMA	3.1 dBi	-	Fixed
A09-M5SM	Mag Mount	RPSMA	5.1 dBi	-	Fixed
A09-M7SM	Mag Mount	RPSMA	7.1 dBi	-1.1 dB*	Fixed
A09-M8SM	Mag Mount	RPSMA	8.1 dBi	-2.1 dB*	Fixed
A09-M0TM	Mag Mount	RPTNC	0 dBi	-	Fixed
A09-M2TM	Mag Mount	RPTNC	2.1 dBi	-	Fixed
A09-M3TM	Mag Mount	RPTNC	3.1 dBi	-	Fixed
A09-M5TM	Mag Mount	RPTNC	5.1 dBi	-	Fixed
A09-M7TM	Mag Mount	RPTNC	7.1 dBi	-1.1 dB*	Fixed
A09-M8TM	Mag Mount	RPTNC	8.1 dBi	-2.1 dB*	Fixed

**Table A-05. Multi-path antennas (approved when operating at 1-watt power output or lower)**

Part Number	Type	Connector	Gain	Application
A09-DPSM-P12F	omni directional permanent mount w/ 12ft pigtail	RPSMA	3.0 dBi	Fixed
A09-D3NF-P12F	omni directional magnetic mount w/ 12ft pigtail	RPN	3.0 dBi	Fixed
A09-D3SM-P12F	omni directional w/ 12ft pigtail	RPSMA	3.0 dBi	Fixed
A09-D3PNF	omni directional permanent mount	RPN	3.0 dBi	Fixed
A09-D3TM-P12F	omni directional w/ 12ft pigtail	RPTNC	3.0 dBi	Fixed
A09-D3PTM	omni directional permanent mount	RPTNC	3.0 dBi	Fixed
A92-D4PNF	900 MHz / 2.4GHz permanent mount	RPN	2.1 dBi	Fixed
A92-D4P	900 MHz / 2.4GHz permanent mount	RPSMA	2.1 dBi	Fixed
A92-D4PTM	900 MHz / 2.4GHz permanent mount	RPTNC	2.1 dBi	Fixed

\* FCC regulations stipulate a 36 dBm EIRP power requirement. Users implementing antenna gain greater than 6.0 dB must compensate for the added gain with cable loss. When operating at 1 W power output, the sum (in dB) of cable loss and antenna gain shall not exceed 6.0 dB.

#### Antenna Options (100 mW transmit power output or lower)

**Table A-06. Half-wave antennas (approved when operating at 100 mW power output or lower)**

Part Number	Type	Connector	Gain	Application
A09-QW	Quarter-wave wire	Permanent	1.9 dBi	Fixed / Mobile
A09-QRAMM	3" Quarter-wave wire	MMCX	2.1 dBi	Fixed / Mobile
A09-QSM-3	Quarter-wave straight	RPSMA	1.9 dBi	Fixed / Mobile
A09-QSM-3H	Heavy duty quarter-wave straight	RPSMA	1.9 dBi	Fixed / Mobile
A09-QBMM-P6I	Quarter-wave w/ 6" pigtail	MMCX	1.9 dBi	Fixed / Mobile
A09-QHRN	Miniature Helical Right Angle solder	Permanent	-1 dBi	Fixed / Mobile
A09-QHSN	Miniature Helical Right Angle solder	Permanent	-1 dBi	Fixed / Mobile
A09-QHSM-2	2" Straight	RPSMA	1.9 dBi	Fixed / Mobile
A09-QHRSM-2	2" Right angle	RPSMA	1.9 dBi	Fixed / Mobile
A09-QHRSM-170	1.7" Right angle	RPSMA	1.9 dBi	Fixed / Mobile
A09-QRSM-380	3.8" Right angle	RPSMA	1.9 dBi	Fixed / Mobile
A09-QAPM-520	5.2" Articulated Screw mount	Permanent	1.9 dBi	Fixed / Mobile
A09-QSPM-3	3" Straight screw mount	Permanent	1.9 dBi	Fixed / Mobile
A09-QAPM-3	3" Articulated screw mount	Permanent	1.9 dBi	Fixed / Mobile
A09-QAPM-3H	3" Articulated screw mount	Permanent	1.9 dBi	Fixed / Mobile

**Table A-07. Yagi antennas** (approved when operating at 100 mW power output or lower)

Part Number	Type	Connector	Gain	Application
A09-Y6	2 Element Yagi	RPN	6.1 dBi	Fixed / Mobile
A09-Y7	3 Element Yagi	RPN	7.1 dBi	Fixed / Mobile
A09-Y8	4 Element Yagi	RPN	8.1 dBi	Fixed / Mobile
A09-Y9	4 Element Yagi	RPN	9.1 dBi	Fixed / Mobile
A09-Y10	5 Element Yagi	RPN	10.1 dBi	Fixed / Mobile
A09-Y11	6 Element Yagi	RPN	11.1 dBi	Fixed / Mobile
A09-Y12	7 Element Yagi	RPN	12.1 dBi	Fixed / Mobile
A09-Y13	9 Element Yagi	RPN	13.1 dBi	Fixed / Mobile
A09-Y14	10 Element Yagi	RPN	14.1 dBi	Fixed / Mobile
A09-Y14	12 Element Yagi	RPN	14.1 dBi	Fixed / Mobile
A09-Y15	13 Element Yagi	RPN	15.1 dBi	Fixed / Mobile
A09-Y15	15 Element Yagi	RPN	15.1 dBi	Fixed / Mobile
A09-Y6TM	2 Element Yagi	RPTNC	6.1 dBi	Fixed / Mobile
A09-Y7TM	3 Element Yagi	RPTNC	7.1 dBi	Fixed / Mobile
A09-Y8TM	4 Element Yagi	RPTNC	8.1 dBi	Fixed / Mobile
A09-Y9TM	4 Element Yagi	RPTNC	9.1 dBi	Fixed / Mobile
A09-Y10TM	5 Element Yagi	RPTNC	10.1 dBi	Fixed / Mobile
A09-Y11TM	6 Element Yagi	RPTNC	11.1 dBi	Fixed / Mobile
A09-Y12TM	7 Element Yagi	RPTNC	12.1 dBi	Fixed / Mobile
A09-Y13TM	9 Element Yagi	RPTNC	13.1 dBi	Fixed / Mobile
A09-Y14TM	10 Element Yagi	RPTNC	14.1 dBi	Fixed / Mobile
A09-Y14TM	12 Element Yagi	RPTNC	14.1 dBi	Fixed / Mobile
A09-Y15TM	13 Element Yagi	RPTNC	15.1 dBi	Fixed / Mobile
A09-Y15TM	15 Element Yagi	RPTNC	15.1 dBi	Fixed / Mobile

## IC (Industry Canada) Certification

### Labeling Requirements

Labeling requirements for Industry Canada are similar to those of the FCC. A clearly visible label on the outside of the final product enclosure must display the following text:

**Contains Model 9XTend Radio, IC: 4214A-9XTEND**

The integrator is responsible for its product to comply with IC ICES-003 & FCC Part 15, Sub. B - Unintentional Radiators. ICES-003 is the same as FCC Part 15 Sub. B and Industry Canada accepts FCC test report or CISPR 22 test report for compliance with ICES-003.

## C-TICK (Australia) Certification

### Power Requirements

Regulations in Australia stipulate a maximum of 30 dBm EIRP (Effective Isotropic Radiated Power). The EIRP equals the sum (in dBm) of power output, antenna gain and cable loss and cannot not exceed 30 dBm.

Figure A-02. EIRP Formula for Australia

$$\text{Power Output} + \text{Antenna Gain} - \text{Cable Loss} \leq 30 \text{ dBm}$$

NOTE: The maximum EIRP for the FCC (United States) and IC (Canada) is 36 dBm.

# Appendix B: Development Guide

## Development Kit Contents

The 9XTend Development Kit includes the hardware and software needed to rapidly create long range wireless links between devices.

**Table B-01. XTend Development Kit Contents**

Item	Qty.	Description	Part Number
XTend OEM RF Module	1	Long Range 900 MHz RF Module (w/ RPSMA Connector)	XT09-SI
XTend OEM RF Module	1	Long Range 900 MHz RF Module (w/ MMCX antenna)	XT09-MI
Antenna	1	900 MHz RPSMA, 6" Half-Wave, dipole, articulating, RPSMA	A09-HASM-675
Antenna	1	900 MHz RPSMA, 7" Half-Wave, dipole, articulating, w/ pigtail, MMCX	A09-HABMM-P5I
RS-232 Interface Board	2	Enables communication to RS-232 devices	XTIB-R
RS-232 Cable (6')	2	Connects interface board to devices having an RS-232 serial port	JD2D3-CDS-6F
Serial Loopback Adapter	1	Connects to the female RS-232 (DB-9) serial connector of the MaxStream Interface Board and can be used to configure the module to function as a repeater (for range testing)	JD2D3-CDL-A
NULL Modem Adapter (male-to-male)	1	Connects to the female RS-232 (DB-9) serial connector of the MaxStream Interface Board and can be used to connect the module to another DCE (female DB9) device	JD2D2-CDN-A
NULL Modem Adapter (female-to-female)	1	Used to bypass radios to verify serial cabling is functioning properly	JD3D3-CDN-A
Male DB-9 to RJ-45 Adapter	1	Facilitates adapting the DB-9 Connector of the MaxStream Interface Board to a CAT5 cable (male DB9 to female RJ45)	JE1D2-CDA-A
Female DB-9 to RJ-45 Adapter	1	Facilitates adapting the DB-9 Connector of the MaxStream Interface Board to a CAT5 cable (female DB9 to female RJ45)	JE1D3-CDA-A
Power Adapter	2	Allows Interface Board to be powered by a 110 Volt AC power supply (not included with international (-INT) development kits)	JP4P2-9V10-6F
CD	1	Contains documentation, software and tools needed for RF operation.	MD0010
Quick Start Guide	1	Familiarizes users with some of the module's most important functions.	MD0016

## Interfacing Hardware

The XTend Development Kit includes a pair of RS-232 interface boards that supports the RS-232/485/422 protocols. When the modules are mounted to the interface boards, the boards provide the following development tools:

- Fast and direct connection to serial devices (such as PCs) and therefore easy access to the module registries - The parameters stored in the registry allow OEMs and integrators to customize the modules to suite the specific needs of their data systems.
- External DIP switch for automatic configuration of commonly used module profiles
- Conversion of signals between TTL levels and RS-232 levels

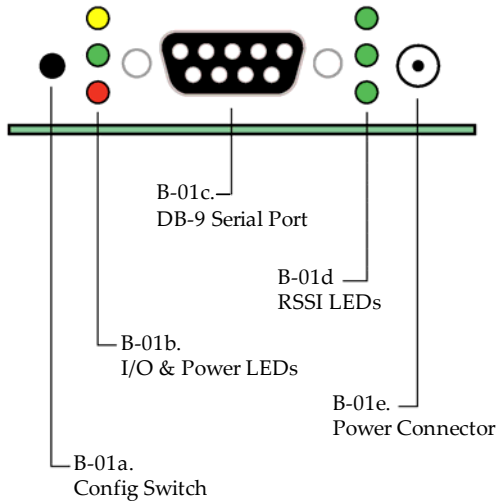
The MaxStream Interface board provides means for connecting the module to any device that has an available RS-232 or RS-485/422 connection. The following sections illustrate how to use the interface boards for development purposes.

Note: In the sections the follow, an OEM RF module mounted to an interface board will be referred to as a "Module Assembly".

# XTIB-R RS-232/485 Interface Board

## B-01a. Config (Configuration) Switch

Figure B-01. Front View



The Config Switch provides an alternate method for entering into Command Mode. To enter Command Mode at the module's default RF data rate, hold the Configuration Switch down for two seconds.

## B-01b. I/O & Power LEDs

The LEDs visualize gigantic status information and indicate module activity as follows:

- Yellow (top LED) = Serial Data Out (to host)
- Green (middle) = Serial Data In (from host)
- Red (bottom) = Power/TX Indicator (Red light is on when powered; it pulses on/off briefly during RF transmission.)



## B-01c. DB-9 Serial Port

Standard female DB-9 (RS-232) connector. This connector can also be used for RS-485 and RS-422 connections.

## B-01d. RSSI LEDs

RSSI LEDs indicate the amount of fade margin present in an active wireless link. Fade margin is defined as the difference between the incoming signal strength and the module's receiver sensitivity.

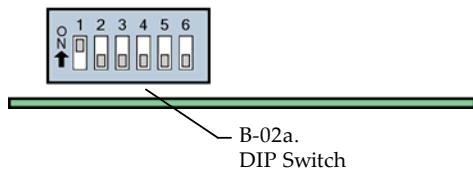
- 3 LEDs ON = Very Strong Signal (> 30 dB fade margin)
- 2 LEDs ON = Strong Signal (> 20 dB fade margin)
- 1 LED ON = Moderate Signal (> 10 dB fade margin)
- 0 LED ON = Weak Signal (< 10 dB fade margin)

## B-01e. Power Connector

7-28 VDC power connector (Center positive, 5.5/2.1mm)  
 Note: The XTIB-R interface board can accept voltages as low as 5V. Contact MaxStream Technical Support to enable this option.

## B-02a. DIP Switch

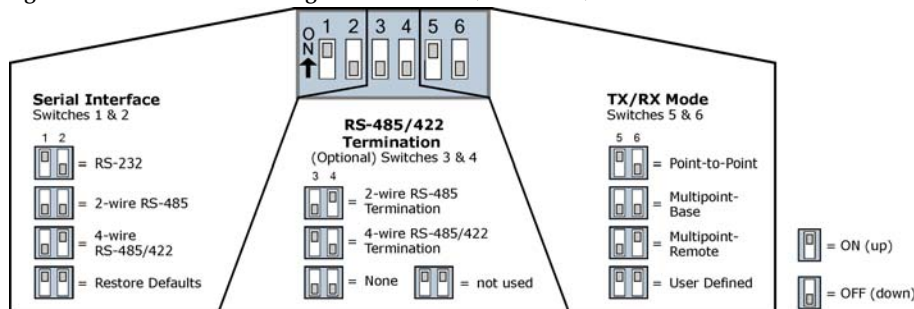
Figure B-02. Back View



DIP Switch automatically configures the module to operate in different modes during the power-on sequence. Each time the module assembly (interface board + module) is powered-on, intelligence on the board programs the attached module according to the positions of the DIP Switch.

Figure B-03 illustrates DIP Switch settings. Table B-02 summarizes the configurations triggered by the positions of the DIP Switch.

Figure B-03. DIP Switch Settings of the XTIB-R (RS-232/485) Interface Board



Refer to the tables in the 'Automatic DIP Switch Configurations' section [next page] regarding configurations triggered by the positions of the DIP Switch (during power-up).

## Automatic DIP Switch Configurations

Each time the module assembly is powered-on, AT commands are sent to the on-board RF module as dictated by the positions of the DIP switches. DIP switch configurations are sent automatically during the power-on sequence and affect module parameter values as shown in the table below.

Figure B-04. XTIB-R DIP Switch

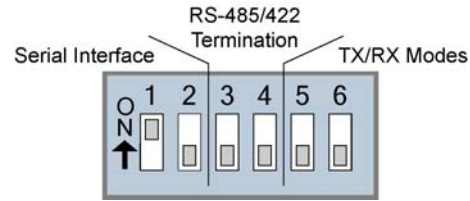


Table B-02. Power-up Options - Commands sent to the module as result of DIP Switch Settings (SW = DIP Switch)

Switches	Condition	Behavior	Commands Sent During Power-up	
Switches 1 & 2 (Restore Defaults / Serial Interfacing)	If SW1 & SW2 are ON (up)	Restore Defaults	ATRE ATWR	(Restore Defaults) (Write defaults to non-volatile memory)
	If SW1 is ON (up)	RS-232 Operation	ATCS 0	(RS-232, CTS flow control)
	If SW1 is OFF (down)	RS-485/422 Operation	ATCS 3	(RS-485 or RS-422 Operation)
Switches 5 & 6 (TX/RX Modes)	If SW5 & SW6 are OFF (down)	Multipoint Base	ATMY 0 ATDT FFFF ATMT 3	(Source Address) (Destination Address) (Multi-Transmit option)
	If SW5 is OFF (down) & SW6 is ON (up)	Multipoint Remote	ATAM ATDT 0 ATMT 0 ATRR A	(Auto-set MY, MY = unique) (Destination Address) (Multi-Transmit option) (Retries)
	If SW5 is ON (up) & SW6 is OFF (down)	Point-to-Point	ATAM ATDT FFFF ATMT 3	(Auto-set MY, MY = unique) (Destination Address) (Multi-Transmit option)
	If SW5 is ON (up) & SW6 is ON (up)	User Defined	Processor is disabled and AT Commands are not sent to the module (except for CS command as shown below.)	

**IMPORTANT:** To avoid overwriting previously stored custom configurations (due to the automatic configurations that take place each time the RF module is powered-on), it is necessary to disable a processor located inside the module.

To disable the processor, turn switches 5 and 6 ON (up). When switches 5 and 6 are ON, only the CS command is sent [refer to table below].

Table B-03. User Defined Mode (Switches 5 and 6 are ON (up))

Only DIP Switches ON (up)	Condition	Command Sent During Power-up	
SW1, SW5 and SW6	If CS = 0, 1, 2 or 4	CS parameter remains the same	
	If CS = 3	ATCS 0	(RS-232 operation, CTS flow control)
SW2, SW5 and SW6	If CS = 2	ATCS 2	(GPO1 high)
	If CS = 0, 1, 3 or 4	ATCS 3	(RS-485/422 Operation)
SW5 and SW6 only	If CS = 2	ATCS 2	(GPO1 high)
	If CS = 0, 1, 3 or 4	ATCS 3	(RS-485/422 Operation)

Note: The results of SW 2, 5 & 6 ON and SW 5 & 6 ON are the same.

## Adapters

The development kit includes several adapters that facilitate the following functions:

- Performing Range Tests
- Testing Cables
- Connecting to other RS-232 DCE and DTE devices
- Connecting to terminal blocks or RJ-45 (for RS-485/422 devices)

### NULL Modem Adapter (male-to-male)

**Part Number: JD2D2-CDN-A (Black, DB-9 M-M)** The male-to-male NULL modem adapter is used to connect two DCE devices. A DCE device connects with a straight-through cable to the male serial port of a computer (DTE).

Figure B-05. Male NULL modem adapter and pinouts

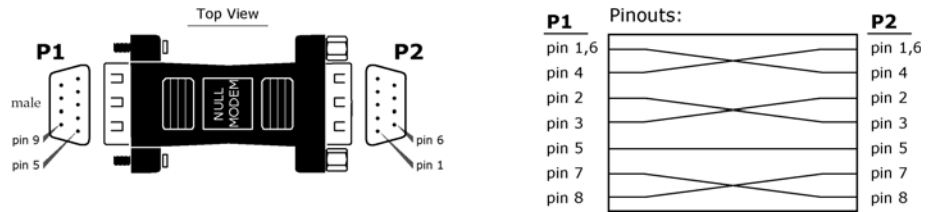
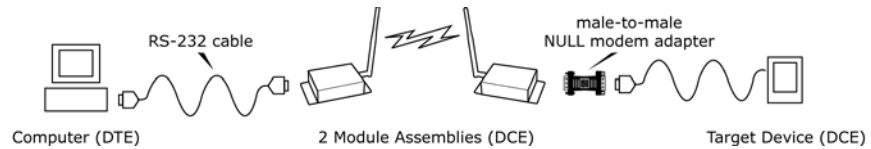


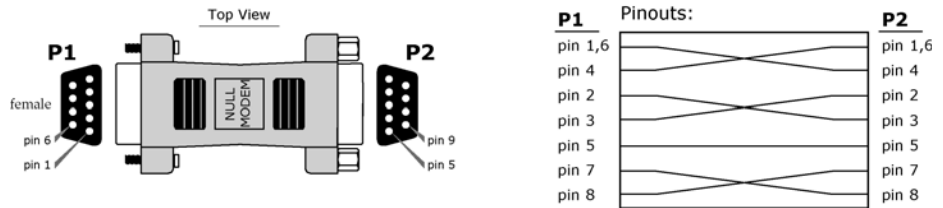
Figure B-06. Example of a MaxStream Radio Modem (DCE Device) connecting to another DCE device



### NULL Modem Adapter (female-to-female)

**Part Number: JD3D3-CDN-A (Gray, DB-9 F-F)** The female-to-female NULL modem adapter is used to verify serial cabling is functioning properly. To test cables, insert the female-to-female NULL modem adapter in place of a pair of module assemblies (RS-232 interface board + XTend RF Module) and test the connection without modules in the connection.

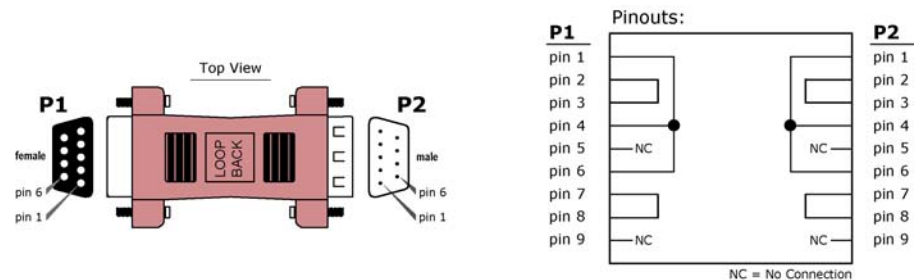
Figure B-07. Female NULL modem adapter and pinouts



### Serial Loopback Adapter

**Part Number: JD2D3-CDL-A (Red, DB-9 M-F)** The serial loopback adapter is used for range testing. During a range test, the serial loopback adapter configures the module to function as a repeater by looping serial data back into the radio for retransmission.

Figure B-08. Serial loopback adapter and pinouts

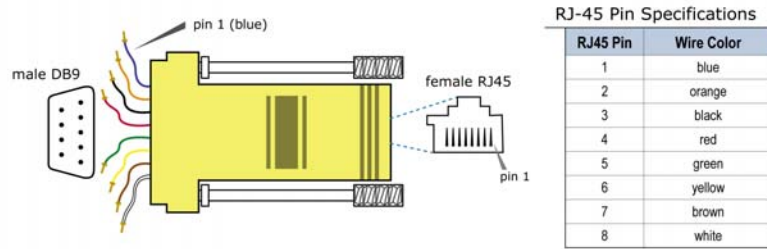


**Male DB-9 to RJ-45 Adapter**

**Part Number: JD2D2-CDN-A (Yellow)** This adapter facilitates adapting the DB-9 Connector of the MaxStream Interface Board to a CAT5 cable (male DB9 to female RJ45).

Refer to the 'RS-485 (4-wire) & RS-422 Operation' sections for RS-485/422 connection guidelines.

**Figure B-09. Male DB-9 to RJ-45 Adapter and pinouts**

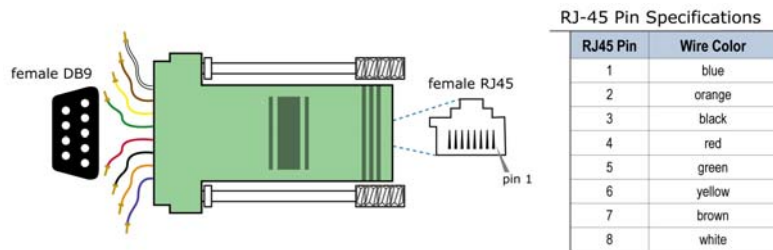


**Female DB-9 to RJ-45 Adapter**

**Part Number: JD3D3-CDN-A (Green)** This adapter facilitates adapting the DB-9 Connector of the MaxStream Interface Board to a CAT5 cable (female DB9 to female RJ45).

Refer to the 'RS-485 (4-wire) & RS-422 Operation' sections for RS-485/422 connection guidelines.

**Figure B-10. Female DB-9 to RJ-45 Adapter and pinouts**



## Interfacing Protocols

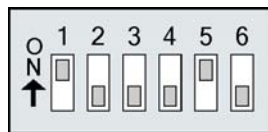
The XTend Module Assembly (XTend OEM RF Module mounted to the XTIB-R Interface Board) supports the following interfacing protocols:

- RS-232
- RS-485 (2-wire) Half-Duplex
- RS-485 (4-wire) and RS-422

### RS-232 Operation

#### DIP Switch Settings and Serial Port Connections

Figure B-11.  
RS-232 DIP Switch Settings



DIP Switch settings are read and applied only while powering-on.

Figure B-12.  
Pins used on the female RS-232 (DB-9) Serial Connector

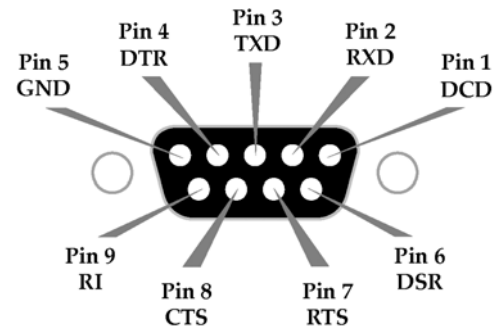


Table B-04. RS-232 Signals and their implementations on the XTend Module Assembly  
(Low-asserted signals are distinguished by horizontal line over pin name.)

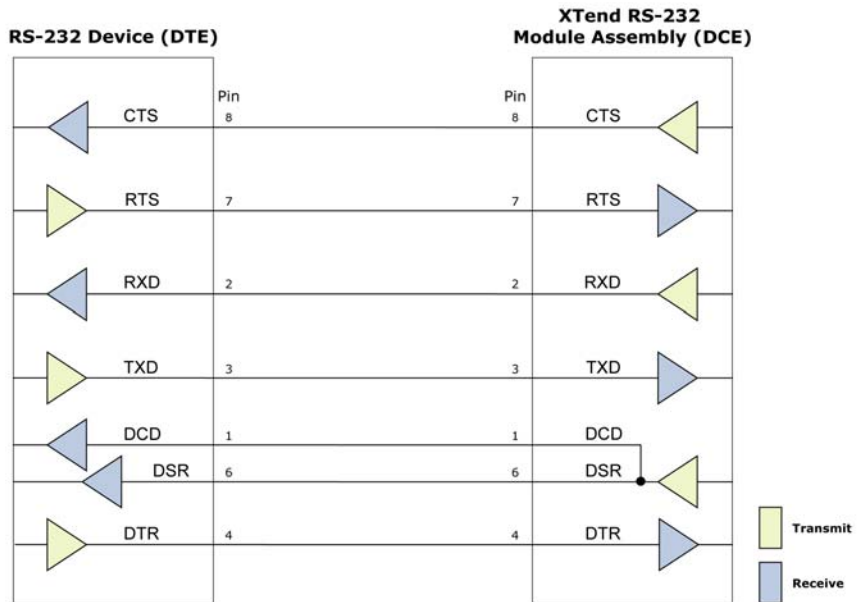
DB-9 Pin	RS-232 Name	X-CTU Name*	Description	Implementation
1	DCD	GPO2	Data-Carrier-Detect	Connected to DSR (pin6 of DB-9)
2	RXD	DO	Received Data	Serial data exiting the module assembly (to host)
3	TXD	DI	Transmitted Data	Serial data entering into the module assembly (from host)
4	DTR	GPI2	Data-Terminal-Ready	Can enable Power-Down on the module assembly
5	GND	-	Ground Signal	Ground
6	DSR	GPO2	Data-Set-Ready	Connected to DCD (pin1 of DB-9)
7	$\overline{\text{RTS}}$ / CMD	GPI1	Request-to-Send / Command Mode	Provides $\overline{\text{RTS}}$ flow control or enables Command Mode
8	$\overline{\text{CTS}}$	GPO1	Clear-to-Send	Provides $\overline{\text{CTS}}$ flow control
9	RI	-	Ring Indicator	Optional power input that is connected internally to the positive lead of the front power connector

\* 'X-CTU' is software that can be used to configure the module. The software includes a naming convention where "GPI" stands for 'General Purpose Input' and "GPO" for 'General Purpose Output'.

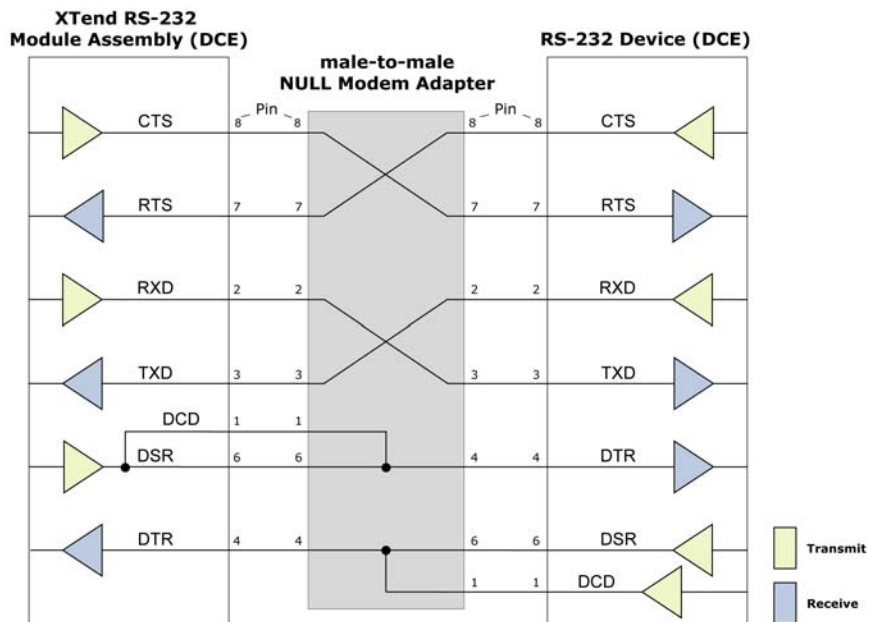


**Wiring Diagrams**

**Figure B-13. DTE Device (RS-232, male DB-9 connector) wired to a DCE Module Assembly (female DB-9)**

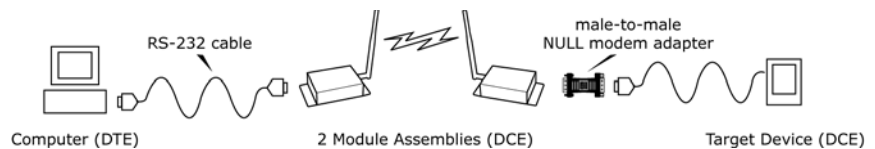


**Figure B-14. DCE Module Assembly (female DB-9 connector) wired to a DCE Device (RS-232, male DB-9)**



**Sample Wireless Connection: DTE <--> DCE ⚡ DCE <--> DCE**

**Figure B-15. Typical wireless link between DTE and DCE devices**

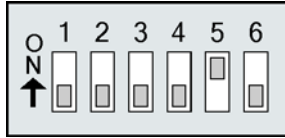


## RS-485 (2-wire) Operation

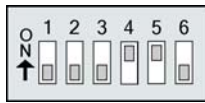
When operating within the RS-485 protocols, all communications are half-duplex.

### DIP Switch Settings and Serial Port Connections

**Figure B-16.**  
RS-485 (2-wire) Half-duplex  
DIP Switch Settings



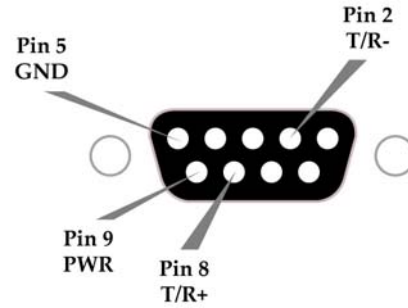
**Figure B-18.**  
RS-485 (2-wire) w/ Termination (optional)



Termination is the 120 Ω resistor between T+ and T-.

DIP Switch settings are read and applied only while powering-on.

**Figure B-17.**  
Pins used on the female RS-232 (DB-9)  
Serial Connector



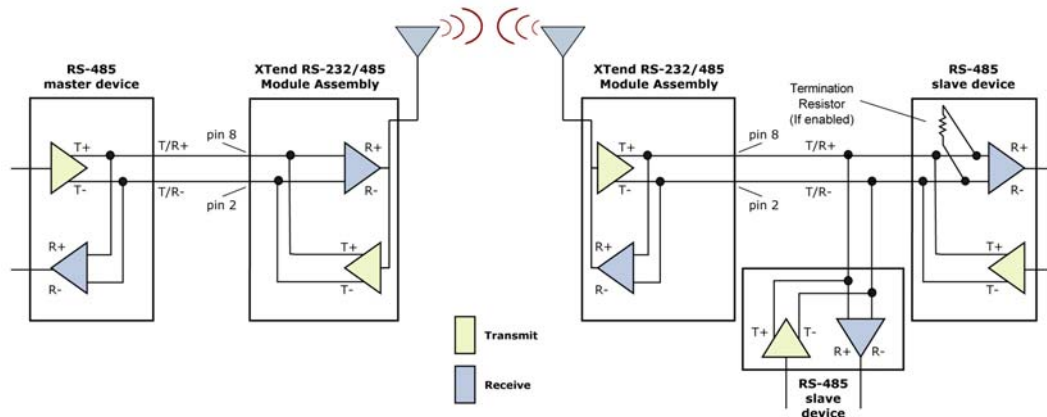
Note: Refer to Figures B-09 and B-10 for RJ-45 connector pin designations used in RS-485/422 environments.

**Table B-05.** RS-485 (2-wire half-duplex) signals and their implementations on the XTend Module Assembly

DB-9 Pin	RS-485 Name	Description	Implementation
2	T/R- (TRA)	Negative Data Line	Transmit serial data to and from the XTend Module Assembly
5	GND	Ground Signal	Ground
8	T/R+ (TRB)	Positive Data Line	Transmit serial data to and from the XTend Module Assembly
9	PWR	Power	Optional power input that is connected internally to the front power connector
1, 3, 4, 6, 7			not used

### Wiring Diagram

**Figure B-19.** XTend Module Assembly in an RS-485 (2-wire) half-duplex environment



## RS-485 (4-wire) & RS-422 Operation

### DIP Switch Settings and Serial Port Connections

Figure B-20.  
RS-485 (4-wire) & RS-422  
DIP Switch Settings

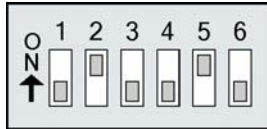
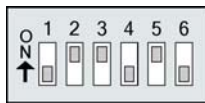


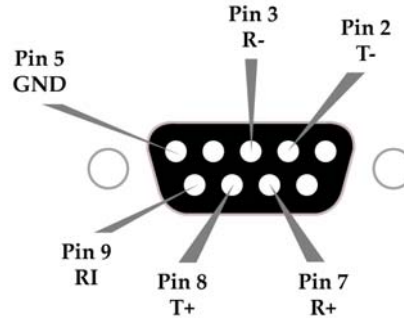
Figure B-22.  
RS-485 (4-wire) & RS-422 w/ Termination (optional)



Termination is the 120 Ω resistor between T+ and T-.

DIP Switch settings are read and applied only while powering-on.

Figure B-21.  
Pins used on the female RS-232 (DB-9)  
Serial Connector



Note: Refer to Figures B-09 and B-10 for RJ-45 connector pin designations used in RS-485/422 environments.

Table B-06. RS-485/422 (4-wire) Signals and their implementations on the XTend Module Assembly

DB-9 Pin	RS-485/422 Name	Description	Implementation
2	T- (TA)	Transmit Negative Data Line	Serial data sent from the XTend Module Assembly
3	R- (RA)	Receive Negative Data Line	Serial data received by the XTend Module Assembly
5	GND	Signal Ground	Ground
7	R+ (RB)	Receive Positive Data Line	Serial data received by the XTend Module Assembly
8	T+ (TB)	Transmit Positive Data Line	Serial data sent from the XTend Module Assembly
9	PWR	Power	Optional power input that is connected internally to the front power connector
1, 4, 6			not used

### Wiring Diagrams

Figure B-23. XTend Module Assembly in an RS-485 (4-wire) environment

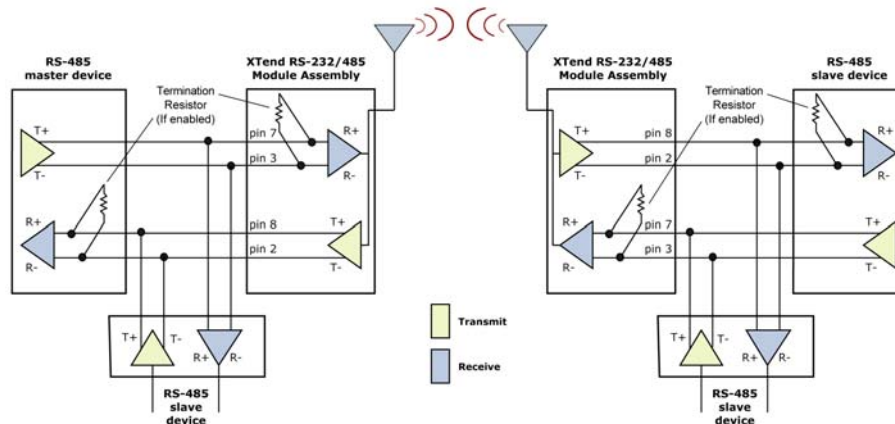
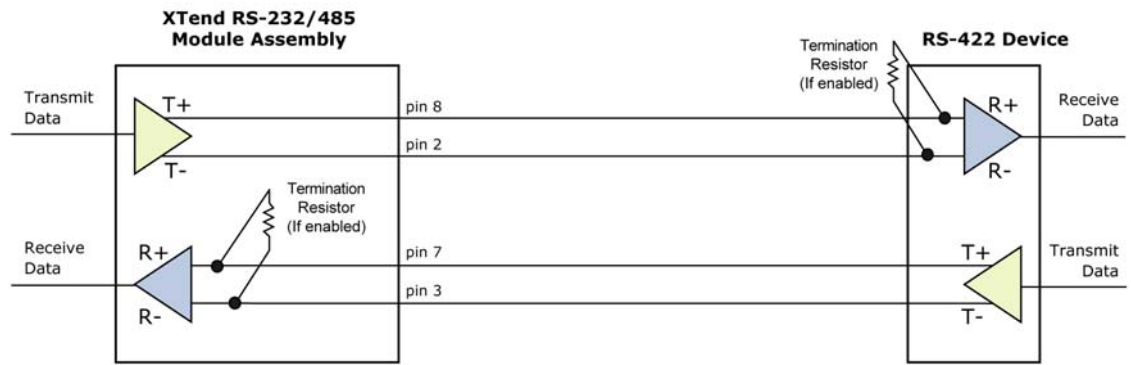


Figure B-24. XTend Module Assembly in an RS-422 environment



### RS-485/422 Connection Guidelines

The RS-485/422 protocol provides a solution for wired communications that can tolerate high noise and push signals over long cable lengths. RS-485/422 signals can communicate as far as 4000 feet (1200 m). RS-232 signals are suitable for cable distances up to 100 feet (30.5 m).

RS-485 offers multi-drop capability in which up to 32 nodes can be connected. The RS-422 protocol is used for point-to-point communications.

#### Suggestions for integrating the XTend RF Module with the RS-485/422 protocol:

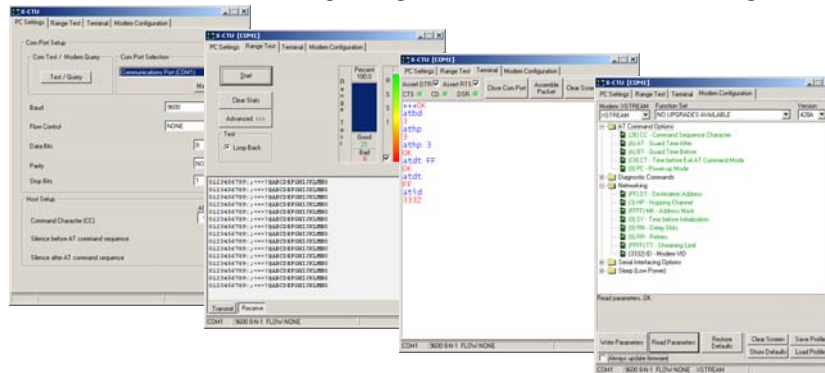
1. When using Ethernet twisted pair cabling: Select wires so that T+ and T- are connected to each wire in a twisted pair. Likewise, select wires so that R+ and R- are connected to a twisted pair. (For example, tie the green and white/green wires to T+ and T-.)
2. For straight-through Ethernet cable (not cross-over cable) - The following wiring pattern works well: Pin3 to T+, Pin4 to R+, Pin5 to R-, Pin6 to T-
3. Note that the connecting cable only requires 4 wires (even though there are 8 wires).
4. When using phone cabling (RJ-11) - Pin2 in the cable maps to Pin3 on opposite end of cable and Pin1 maps to Pin4 respectively.

## X-CTU Software

X-CTU is a MaxStream-provided software program used to interface with and configure Max-Stream RF Modules. The software application is organized into the following four tabs:

- PC Settings tab - Setup PC serial ports for interfacing with an RF module
- Range Test tab - Test the RF module's range and monitor packets sent and received
- Terminal tab - Set and read RF module parameters using AT Commands
- Modem Configuration tab - Set and read RF module parameters

Figure B-11. X-CTU User Interface (PC Settings, Range Test, Terminal and Modem Configuration tabs)



NOTE: PC Setting values are visible at the bottom of the Range Test, Terminal and Modem Configuration tabs. A shortcut for editing PC Setting values is available by clicking on any of the values.

## Installation

Double-click the "setup\_X-CTU.exe" file and follow prompts of the installation screens. This file is located in the 'software' folder of the MaxStream CD and also under the 'Downloads' section of the following web page: [www.maxstream.net/support/downloads.php](http://www.maxstream.net/support/downloads.php)

### Setup

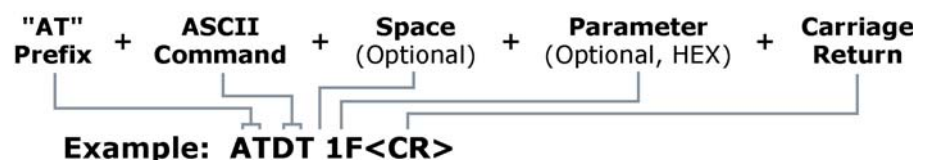
To use the X-CTU software, a module assembly (An RF module mounted to an interface Board) must be connected to a serial port of a PC.

NOTE: Failure to enter AT Command Mode is most commonly due to baud rate mismatch. The interface data rate and parity settings of the serial port ("PC Settings" tab) must match those of the module (BD (Baud Rate) and NB (Parity) parameters respectively).

## Serial Communications Software

A terminal program is built into the X-CTU Software. Other terminal programs such as "HyperTerminal" can also be used to configure modules and monitor communications. When issuing AT Commands through a terminal program interface, use the following syntax:

Figure B-12. Syntax for sending AT Commands



NOTE: To read a parameter value stored in a register, leave the parameter field blank.

The example above issues the DT (Destination Address) command to change destination address of the module to "0x1F". To save the new value to the module's non-volatile memory, issue WR (Write) command after modifying parameters.

# Appendix C: Additional Information

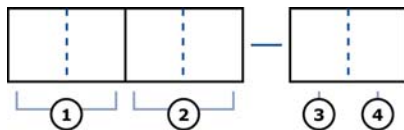
## 1-Year Warranty

XTend RF Modules from MaxStream, Inc. (the "Product") are warranted against defects in materials and workmanship under normal use, for a period of 1-year from the date of purchase. In the event of a product failure due to materials or workmanship, MaxStream will repair or replace the defective product. For warranty service, return the defective product to MaxStream, shipping pre-paid, for prompt repair or replacement.

The foregoing sets forth the full extent of MaxStream's warranties regarding the Product. Repair or replacement at MaxStream's option is the exclusive remedy. THIS WARRANTY IS GIVEN IN LIEU OF ALL OTHER WARRANTIES, EXPRESS OR IMPLIED, AND MAXSTREAM SPECIFICALLY DISCLAIMS ALL WARRANTIES OF MERCHANTABILITY OR FITNESS FOR A PARTICULAR PURPOSE. IN NO EVENT SHALL MAXSTREAM, ITS SUPPLIERS OR LICENSORS BE LIABLE FOR DAMAGES IN EXCESS OF THE PURCHASE PRICE OF THE PRODUCT, FOR ANY LOSS OF USE, LOSS OF TIME, INCONVENIENCE, COMMERCIAL LOSS, LOST PROFITS OR SAVINGS, OR OTHER INCIDENTAL, SPECIAL OR CONSEQUENTIAL DAMAGES ARISING OUT OF THE USE OR INABILITY TO USE THE PRODUCT, TO THE FULL EXTENT SUCH MAY BE DISCLAIMED BY LAW. SOME STATES DO NOT ALLOW THE EXCLUSION OR LIMITATION OF INCIDENTAL OR CONSEQUENTIAL DAMAGES. THEREFORE, THE FOREGOING EXCLUSIONS MAY NOT APPLY IN ALL CASES. This warranty provides specific legal rights. Other rights which vary from state to state may also apply.

## Ordering Information

Figure C-01. Divisions of the XTend RF Module Part Numbers



Divisions of the MaxStream OEM RF Module Part Number:

① **MaxStream Product Family**

XT = XTend

② **Operating Frequency**

09 = 902-928 MHz

③ **Antenna Connector**

M = MMCX

S = RPSMA (Reverse Polarity SMA)

④ **Temperature Rating**

I = Industrial (-40 to 85° C, conformal coated)

T = Tested (-40 to 85° C, conformal coated, 100% tested)

For example:

XT09-SI = 9XTend OEM RF Module, 900 MHz, RPSMA Antenna, Industrial Temperature Rating

## Contact MaxStream

---

Free and unlimited technical support is included with every MaxStream Radio Modem sold. For the best in wireless data solutions and support, please use the following resources:

Documentation:	<a href="http://www.maxstream.net/support/downloads.php">www.maxstream.net/support/downloads.php</a>	
Technical Support:	Phone.	(866) 765-9885 toll-free U.S.A. & Canada (801) 765-9885 Worldwide
	Live Chat.	<a href="http://www.maxstream.net">www.maxstream.net</a>
	E-Mail.	<a href="mailto:rf-xperts@maxstream.net">rf-xperts@maxstream.net</a>

MaxStream office hours are 8:00 am - 5:00 pm [U.S. Mountain Standard Time]

# Mouser Electronics

Authorized Distributor

Click to View Pricing, Inventory, Delivery & Lifecycle Information:

DIGI:

[A09-HSM-7](#) [A09-HASM-675](#) [A24-HABMM-P5I](#) [A24-HBMM-P6I](#) [A09-HABMM-P5I](#)