

# Varistors (ZNR Surge Absorber)

D type

V series



For Varistor Voltages ranging from 200 to 1100V, kindly also consider corresponding, smaller E Series devices with better performance for their size. → [Please click here](#)

## Features

- Large withstanding surge current capability in compact sizes
- Large “Energy Handling Capability” absorbing transient overvoltages in compact sizes
- Wide range of varistor voltages
- RoHS compliant

## Recommended applications

- Transistor, diode, IC, thyristor or triac semiconductor protection
- Surge protection in consumer electronic equipment
- Surge protection in communication, measuring or controller electronics
- Surge protection in electronic home appliances, gas or petroleum appliances

## Applicable standards

- UL1449 (VZCA2/UL, VZCA8/C-UL)
- VDE IEC61051-1, -2, -2-2, IEC60950-1 Annex.Q, IEC62368-1 G8.2
- CSA C22.2 N 269.5
- CQC (GB/T10193, GB/T10194, GB4943.1, GB8898)

Refer to "Standard Products" , and "Application Note for Safety Standards" , for the details.

■ As for handling precautions and minimum quantity / Packing unit please see related information.

## Explanation of part numbers (Bulk)

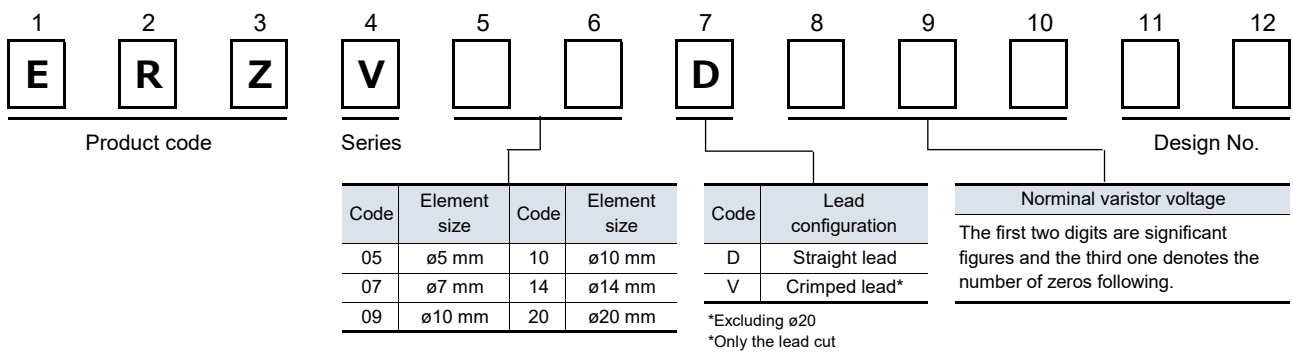

## Explanation of part numbers (Taping)

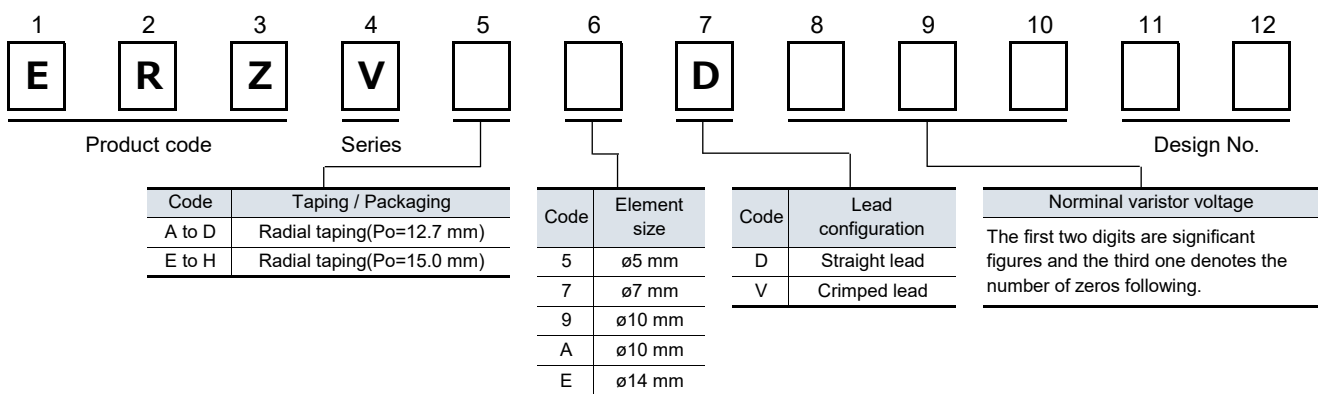

## Reference guide to standard products

Part No.	Applicable standards		Varistor voltage* (V)	Maximum allowable voltage		Clamping voltage 8/20 $\mu$ s		Maximum peak current at 8/20 $\mu$ s (A)	
	Type name	Approvals		AC rms (V)	DC (V)	max.(V)	Ip (A)	1 time	2 times
ERZV05D180	V180	◇	18 (16 to 20)	11	14	40	1	250	125
ERZV07D180	V7180	◇				36	2.5	500	250
ERZV09D180	V9180	◇				36	5	1000	500
ERZV10D180	V10180	◇				36	5	1000	500
ERZV14D180	V14180	◇				36	10	2000	1000
ERZV20D180	V20180	◇				36	20	3000	2000
ERZV05D220	V220	◇	22 (20 to 24)	14	18	48	1	250	125
ERZV07D220	V7220	◇				43	2.5	500	250
ERZV09D220	V9220	◇				43	5	1000	500
ERZV10D220	V10220	◇				43	5	1000	500
ERZV14D220	V14220	◇				43	10	2000	1000
ERZV20D220	V20220	◇				43	20	3000	2000
ERZV05D270	V270	◇	27 (24 to 30)	17	22	60	1	250	125
ERZV07D270	V7270	◇				53	2.5	500	250
ERZV09D270	V9270	◇				53	5	1000	500
ERZV10D270	V10270	◇				53	5	1000	500
ERZV14D270	V14270	◇				53	10	2000	1000
ERZV20D270	V20270	◇				53	20	3000	2000
ERZV05D330	V330	◇	33 (30 to 36)	20	26	73	1	250	125
ERZV07D330	V7330	◇				65	2.5	500	250
ERZV09D330	V9330	◇				65	5	1000	500
ERZV10D330	V10330	◇				65	5	1000	500
ERZV14D330	V14330	◇				65	10	2000	1000
ERZV20D330	V20330	◇				65	20	3000	2000
ERZV05D390	V390	◇	39 (35 to 43)	25	31	86	1	250	125
ERZV07D390	V7390	◇				77	2.5	500	250
ERZV09D390	V9390	◇				77	5	1000	500
ERZV10D390	V10390	◇				77	5	1000	500
ERZV14D390	V14390	◇				77	10	2000	1000
ERZV20D390	V20390	◇				77	20	3000	2000
ERZV05D470	V470	◇	47 (42 to 52)	30	38	104	1	250	125
ERZV07D470	V7470	◇				93	2.5	500	250
ERZV09D470	V9470	◇				93	5	1000	500
ERZV10D470	V10470	◇				93	5	1000	500
ERZV14D470	V14470	◇				93	10	2000	1000
ERZV20D470	V20470	◇				93	20	3000	2000
ERZV05D560	V560	◇	56 (50 to 62)	35	45	123	1	250	125
ERZV07D560	V7560	◇				110	2.5	500	250
ERZV09D560	V9560	◇				110	5	1000	500
ERZV10D560	V10560	◇				110	5	1000	500
ERZV14D560	V14560	◇				110	10	2000	1000
ERZV20D560	V20560	◇				110	20	3000	2000
ERZV05D680	V680	◇	68 (61 to 75)	40	56	150	1	250	125
ERZV07D680	V7680	◇				135	2.5	500	250
ERZV09D680	V9680	◇				135	5	1000	500
ERZV10D680	V10680	◇				135	5	1000	500
ERZV14D680	V14680	◇				135	10	2000	1000
ERZV20D680	V20680	◇				135	20	3000	2000

\* Measuring Current of Varistor Voltage 5 Series (ERZV05D □□□) : 0.1 mA, Others : 1 mA

○ : UL1449 (VZCA2/UL, VZCA8/C-UL),

☆ : VDE (IEC61051-1, -2, -2-2), ★ : VDE (IEC60950-1 Annex.Q, IEC62368-1 G8.2), □ : CSA C22.2 No.269.5

◇ : CQC (GB/T10193, GB/T10194), ◆ : CQC (GB4943.1, GB8898)

※ Approval number (File No.) of safety regulations are subject to revision without notice. Ask factory for a copy of the latest file No.

## Reference guide to standard products

Part No.	Applicable standards		Varistor voltage* (V)	Maximum allowable voltage		Clamping voltage 8/20 $\mu$ s		Maximum peak current at 8/20 $\mu$ s (A)	
	Type name	Approvals		AC rms (V)	DC (V)	max.(V)	Ip (A)	1 time	2 times
ERZV05D820	V820U	○☆◇	82 (74 to 90)	50	65	145	5	800	600
ERZV07D820	V7820U	○☆◇				135	10	1750	1250
ERZV09D820	V9820U	○☆◇				135	25	3500	2500
ERZV10D820	V10820U	○☆◇				135	25	3500	2500
ERZV14D820	V14820U	○☆◇				135	50	6000	5000
ERZV20D820	V20820U	○☆◇				135	100	10000	7000
ERZV05D101	V101U	○☆◇	100 (90 to 110)	60	85	175	5	800	600
ERZV07D101	V7101U	○☆◇				165	10	1750	1250
ERZV09D101	V9101U	○☆◇				165	25	3500	2500
ERZV10D101	V10101U	○☆◇				165	25	3500	2500
ERZV14D101	V14101U	○☆◇				165	50	6000	5000
ERZV20D101	V20101U	○☆◇				165	100	10000	7000
ERZV05D121	V121U	○☆◇	120 (108 to 132)	75	100	210	5	800	600
ERZV07D121	V7121U	○☆◇				200	10	1750	1250
ERZV09D121	V9121U	○☆◇				200	25	3500	2500
ERZV10D121	V10121U	○☆◇				200	25	3500	2500
ERZV14D121	V14121U	○☆◇				200	50	6000	5000
ERZV20D121	V20121U	○☆◇				200	100	10000	7000
ERZV05D151	V151U	○☆◇	150 (135 to 165)	95	125	260	5	800	600
ERZV07D151	V7151U	○☆◇				250	10	1750	1250
ERZV09D151	V9151U	○☆◇				250	25	3500	2500
ERZV10D151	V10151U	○☆◇				250	25	3500	2500
ERZV14D151	V14151U	○☆◇				250	50	6000	5000
ERZV20D151	V20151U	○☆◇				250	100	10000	7000
ERZV05D201	V201U	○☆□◇	200 (185 to 225)	130	170	355	5	800	600
ERZV07D201	V7201U	○☆□◇				340	10	1750	1250
ERZV09D201	V9201U	○☆□◇				340	25	3500	2500
ERZV10D201	V10201U	○☆□◇				340	25	3500	2500
ERZV14D201	V14201U	○☆★□◇◆				340	50	6000	5000
ERZV20D201	V20201U	○☆★□◇◆				340	100	10000	7000
ERZV05D221	V221U	○☆□◇	220 (198 to 242)	140	180	380	5	800	600
ERZV07D221	V7221U	○☆□◇				360	10	1750	1250
ERZV09D221	V9221U	○☆□◇				360	25	3500	2500
ERZV10D221	V10221U	○☆□◇				360	25	3500	2500
ERZV14D221	V14221U	○☆★□◇◆				360	50	6000	5000
ERZV20D221	V20221U	○☆★□◇◆				360	100	10000	7000
ERZV05D241	V241U	○☆□◇	240 (216 to 264)	150	200	415	5	800	600
ERZV07D241	V7241U	○☆□◇				395	10	1750	1250
ERZV09D241	V9241U	○☆□◇				395	25	3500	2500
ERZV10D241	V10241U	○☆□◇				395	25	3500	2500
ERZV14D241	V14241U	○☆★□◇◆				395	50	6000	5000
ERZV20D241	V20241U	○☆★□◇◆				395	100	10000	7000
ERZV05D271	V271U	○☆□◇	270 (247 to 303)	175	225	475	5	800	600
ERZV07D271	V7271U	○☆□◇				455	10	1750	1250
ERZV09D271	V9271U	○☆□◇				455	25	3500	2500
ERZV10D271	V10271U	○☆□◇				455	25	3500	2500
ERZV14D271	V14271U	○☆★□◇◆				455	50	6000	5000
ERZV20D271	V20271U	○☆★□◇◆				455	100	10000	7000

\* Measuring Current of Varistor Voltage 5 Series (ERZV05D □□□) : 0.1 mA, Others : 1 mA

○: UL1449 (VZCA2/UL, VZCA8/C-UL),

☆: VDE (IEC61051-1, -2, -2-2), ★: VDE (IEC60950-1 Annex.Q, IEC62368-1 G8.2), □: CSA C22.2 No.269.5

◇: CQC (GB/T10193, GB/T10194), ◆: CQC (GB4943.1, GB8898)

※Approval number (File No.) of safety regulations are subject to revision without notice. Ask factory for a copy of the latest file No.

Reference guide to standard products

Part No.	Applicable standards		Varistor voltage* (V)	Maximum allowable voltage		Clamping voltage 8/20 μs		Maximum peak current at 8/20 μs (A)	
	Type name	Approvals		AC rms (V)	DC (V)	max.(V)	Ip (A)	1 time	2 times
ERZV05D331	V331U	○☆□◇	330 (297 to 363)	210	270	570	5	800	600
ERZV07D331	V7331U	○☆□◇				545	10	1750	1250
ERZV09D331	V9331U	○☆□◇				545	25	3500	2500
ERZV10D331	V10331U	○☆□◇				545	25	3500	2500
ERZV14D331	V14331U	○☆★□◇◆				545	50	6000	4500
ERZV20D331	V20331U	○☆★□◇◆				545	100	10000	6500
ERZV05D361	V361U	○☆□◇	360 (324 to 396)	230	300	620	5	800	600
ERZV07D361	V7361U	○☆□◇				595	10	1750	1250
ERZV09D361	V9361U	○☆□◇				595	25	3500	2500
ERZV10D361	V10361U	○☆□◇				595	25	3500	2500
ERZV14D361	V14361U	○☆★□◇◆				595	50	6000	4500
ERZV20D361	V20361U	○☆★□◇◆				595	100	10000	6500
ERZV05D391	V391U	○☆□◇	390 (351 to 429)	250	320	675	5	800	600
ERZV07D391	V7391U	○☆□◇				650	10	1750	1250
ERZV09D391	V9391U	○☆□◇				650	25	3500	2500
ERZV10D391	V10391U	○☆□◇				650	25	3500	2500
ERZV14D391	V14391U	○☆★□◇◆				650	50	6000	4500
ERZV20D391	V20391U	○☆★□◇◆				650	100	10000	6500
ERZV05D431	V431U	○☆□◇	430 (387 to 473)	275	350	745	5	800	600
ERZV07D431	V7431U	○☆□◇				710	10	1750	1250
ERZV09D431	V9431U	○☆□◇				710	25	3500	2500
ERZV10D431	V10431U	○☆□◇				710	25	3500	2500
ERZV14D431	V14431U	○☆★□◇◆				710	50	6000	4500
ERZV20D431	V20431U	○☆★□◇◆				710	100	10000	6500
ERZV05D471	V471U	○☆□◇	470 (423 to 517)	300	385	810	5	800	600
ERZV07D471	V7471U	○☆□◇				775	10	1750	1250
ERZV09D471	V9471U	○☆□◇				775	25	3500	2500
ERZV10D471	V10471U	○☆★□◇◆				775	25	3500	2500
ERZV14D471	V14471U	○☆★□◇◆				775	50	6000	4500
ERZV20D471	V20471U	○☆★□◇◆				775	100	10000	6500
ERZV07D511	V7511U	○☆□◇	510 (459 to 561)	320	410	845	10	1750	1250
ERZV09D511	V9511U	○☆□◇				845	25	3500	2500
ERZV10D511	V10511U	○☆★□◇◆				845	25	3500	2500
ERZV14D511	V14511U	○☆★□◇◆				845	50	6000	4500
ERZV20D511	V20511U	○☆★□◇◆				845	100	10000	6500
ERZV10D561	V10561U	○☆★□◇◆				560 (504 to 616)	350	450	930
ERZV14D561	V14561U	○☆★□◇◆	930	50	5000				4500
ERZV20D561	V20561U	○☆★□◇◆	930	100	7500				6500
ERZV10D621	V10621U	○☆★□◇◆	620 (558 to 682)	385	505	1025	25	3500	2500
ERZV14D621	V14621U	○☆★□◇◆				1025	50	5000	4500
ERZV20D621	V20621U	○☆★□◇◆				1025	100	7500	6500
ERZV10D681	V10681U	○☆★□◇◆	680 (612 to 748)	420	560	1120	25	3500	2500
ERZV14D681	V14681U	○☆★□◇◆				1120	50	5000	4500
ERZV20D681	V20681U	○☆★□◇◆				1120	100	7500	6500

\* Measuring Current of Varistor Voltage 5 Series (ERZV05D □□□) : 0.1 mA, Others : 1 mA

○: UL1449 (VZCA2/UL, VZCA8/C-UL),

☆: VDE (IEC61051-1, -2, -2-2), ★ : VDE (IEC60950-1 Annex.Q, IEC62368-1 G8.2), □ : CSA C22.2 No.269.5

◇: CQC (GB/T10193, GB/T10194), ◆ : CQC (GB4943.1, GB8898)

※Approval number (File No.) of safety regulations are subject to revision without notice. Ask factory for a copy of the latest file No.

## Reference guide to standard products

Part No.	Applicable standards		Varistor voltage* (V)	Maximum allowable voltage		Clamping voltage 8/20 $\mu$ s		Maximum peak current at 8/20 $\mu$ s (A)	
	Type name	Approvals		AC rms (V)	DC (V)	max.(V)	Ip (A)	1 time	2 times
ERZV10D751	V10751U	○☆★□◇◆	750 (675 to 825)	460	615	1240	25	3500	2500
ERZV14D751	V14751U	○☆★□◇◆				1240	50	5000	4500
ERZV20D751	V20751U	○☆★□◇◆				1240	100	7500	6500
ERZV10D821	V10821U	○☆★□◇◆	820 (738 to 902)	510	670	1355	25	3500	2500
ERZV14D821	V14821U	○☆★□◇◆				1355	50	5000	4500
ERZV20D821	V20821U	○☆★□◇◆				1355	100	7500	6500
ERZV10D911	V10911U	○☆★□◇◆	910 (819 to 1001)	550	745	1500	25	3500	2500
ERZV14D911	V14911U	○☆★□◇◆				1500	50	5000	4500
ERZV20D911	V20911U	○☆★□◇◆				1500	100	7500	6500
ERZV10D102	V10102U	○☆★□◇◆	1000 (900 to 1100)	625	825	1650	25	3500	2500
ERZV14D102	V14102U	○☆★□◇◆				1650	50	5000	4500
ERZV20D102	V20102U	○☆★□◇◆				1650	100	7500	6500
ERZV10D112	V10112U	○☆★□◇◆	1100 (990 to 1210)	680	895	1815	25	3500	2500
ERZV14D112	V14112U	○☆★□◇◆				1815	50	5000	4500
ERZV20D112	V20112U	○☆★□◇◆				1815	100	7500	6500
ERZV10D182CS	V10182U	○☆★□◇◆	1800 (1700 to 1980)	1000	1465	2970	25	3500	2500
ERZV14D182CS	V14182U	○☆★□◇◆				2970	50	5000	4500
ERZV20D182	V20182U	○☆★□◇◆				2970	100	7500	6500

\* Measuring Current of Varistor Voltage 5 Series (ERZV05D □□□) : 0.1 mA, Others : 1 mA

○: UL1449 (VZCA2/UL, VZCA8/C-UL),

☆: VDE (IEC61051-1, -2, -2-2), ★ : VDE (IEC60950-1 Annex.Q, IEC62368-1 G8.2), □ : CSA C22.2 No.269.5

◇: CQC (GB/T10193, GB/T10194), ◆ : CQC (GB4943.1, GB8898)

※Approval number (File No.) of safety regulations are subject to revision without notice. Ask factory for a copy of the latest file No.

## Ratings and characteristics

● Operating temperature range : -40 to 85 °C

● Storage temperature range : -40 to 125 °C

Part No.	Varistor voltage at 0.1 mA	Maximum allowable voltage		Clamping voltage (max.) **Ip	Rated power	Maximum energy		Maximum peak current (8/20 μs)		Capacitance (max.) at 1 kHz
		(V)	AC rms (V)			DC (V)	(V)	(W)	(10/1000 μs)	
	(J)			(J)	(A)				(A)	(pF)
ERZV05D180	18(16 to 20)	11	14	40	0.01	0.6	0.4	250	125	1600
ERZV05D220	22(20 to 24)	14	18	48	0.01	0.7	0.5	250	125	1500
ERZV05D270	27(24 to 30)	17	22	60	0.01	0.9	0.7	250	125	1450
ERZV05D330	33(30 to 36)	20	26	73	0.01	1.1	0.8	250	125	1400
ERZV05D390	39(35 to 43)	25	31	86	0.01	1.2	0.9	250	125	700
ERZV05D470	47(42 to 52)	30	38	104	0.01	1.5	1.1	250	125	650
ERZV05D560	56(50 to 62)	35	45	123	0.01	1.8	1.3	250	125	600
ERZV05D680	68(61 to 75)	40	56	150	0.01	2.2	1.6	250	125	580
ERZV05D820	82(74 to 90)	50	65	145	0.1	3.5	2.5	800	600	460
ERZV05D101	100(90 to 110)	60	85	175	0.1	4.0	3.0	800	600	400
ERZV05D121	120(108 to 132)	75	100	210	0.1	5.0	3.5	800	600	350
ERZV05D151	150(135 to 165)	95	125	260	0.1	6.5	4.5	800	600	300

★ The following part numbers, kindly also consider corresponding, smaller E Series devices with better performance for their size. → [Please click here](#)

ERZV05D201	200(185 to 225)	130	170	355	0.1	8.5	6.0	800	600	120
ERZV05D221	220(198 to 242)	140	180	380	0.1	9.0	6.5	800	600	110
ERZV05D241	240(216 to 264)	150	200	415	0.1	10.5	7.5	800	600	100
ERZV05D271	270(247 to 303)	175	225	475	0.1	11.0	8.0	800	600	90*
ERZV05D331	330(297 to 363)	210	270	570	0.1	13.0	9.5	800	600	80*
ERZV05D361	360(324 to 396)	230	300	620	0.1	16.0	11.0	800	600	80*
ERZV05D391	390(351 to 429)	250	320	675	0.1	17.0	12.0	800	600	80*
ERZV05D431	430(387 to 473)	275	350	745	0.1	20.0	13.5	800	600	70*
ERZV05D471	470(423 to 517)	300	385	810	0.1	21.0	15.0	800	600	60*

\* Measured at 1 MHz    \*\*Ip Measuring current of clamping voltage 180 to 680 : 1 A, 820 to 471 : 5 A

## Dimensions in mm (not to scale)

Unit : mm

Part No.	D max.	T max.	W±1.0	H max.	L±1.0
ERZV05D180	7.0	4.5	5.0	10.0	1.5
ERZV05D220	7.0	4.5	5.0	10.0	1.5
ERZV05D270	7.0	4.5	5.0	10.0	1.5
ERZV05D330	7.0	4.5	5.0	10.0	1.5
ERZV05D390	7.0	4.5	5.0	10.0	1.5
ERZV05D470	7.0	4.5	5.0	10.0	1.5
ERZV05D560	7.0	4.5	5.0	10.0	1.5
ERZV05D680	7.0	4.5	5.0	10.0	1.5
ERZV05D820	7.0	4.1	5.0	10.0	1.4
ERZV05D101	7.0	4.3	5.0	10.0	1.6
ERZV05D121	7.0	4.5	5.0	10.0	1.8
ERZV05D151	7.0	4.8	5.0	10.0	2.1

★ The following part numbers, kindly also consider corresponding, smaller E Series devices with better performance for their size. → [Please click here](#)

ERZV05D201	7.0	4.4	5.0	10.0	1.7
ERZV05D221	7.0	4.5	5.0	10.0	1.8
ERZV05D241	7.0	4.6	5.0	10.0	1.9
ERZV05D271	7.0	4.8	5.0	10.0	2.1
ERZV05D331	7.0	5.1	5.0	10.0	2.4
ERZV05D361	7.0	5.3	5.0	10.0	2.5
ERZV05D391	7.0	5.4	5.0	10.0	2.7
ERZV05D431	7.0	5.6	5.0	10.0	2.9
ERZV05D471	7.0	5.8	5.0	10.0	3.1

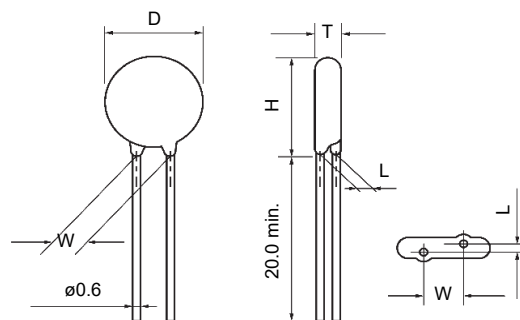

Typical characteristics

Voltage vs. Current

ERZV05D180 to ERZV05D680

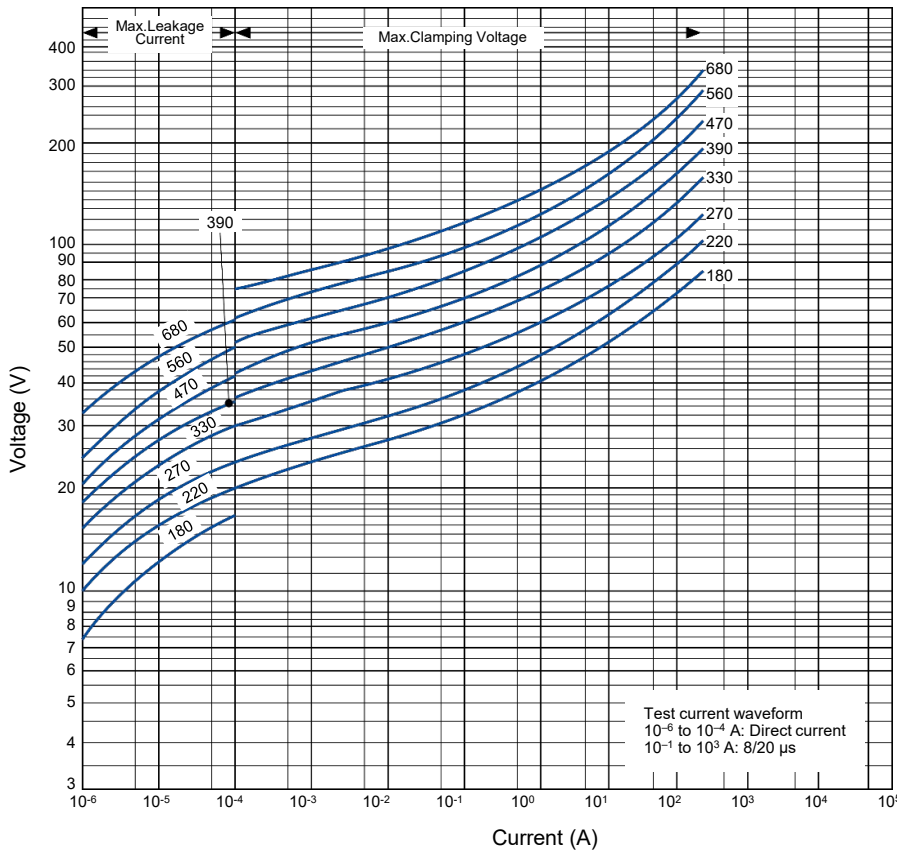

Impulse Derating (Relation between impulse width and impulse current multiple)

ERZV05D180 to ERZV05D680

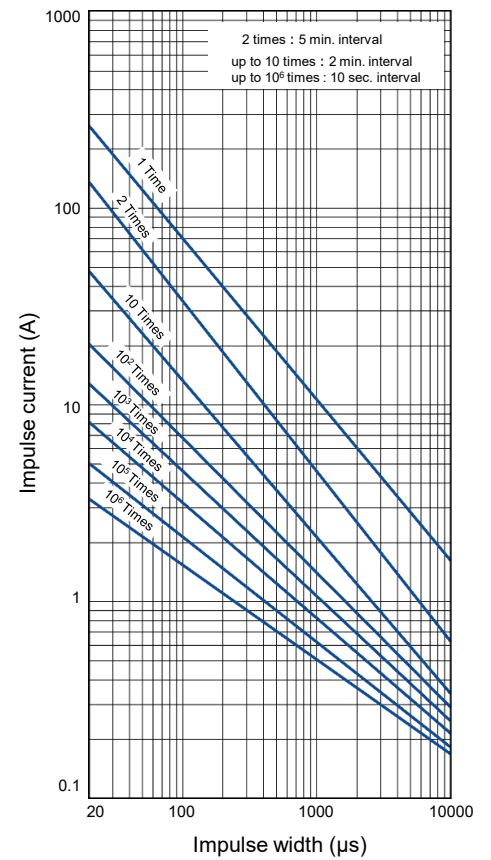

ERZV05D820 to ERZV05D471

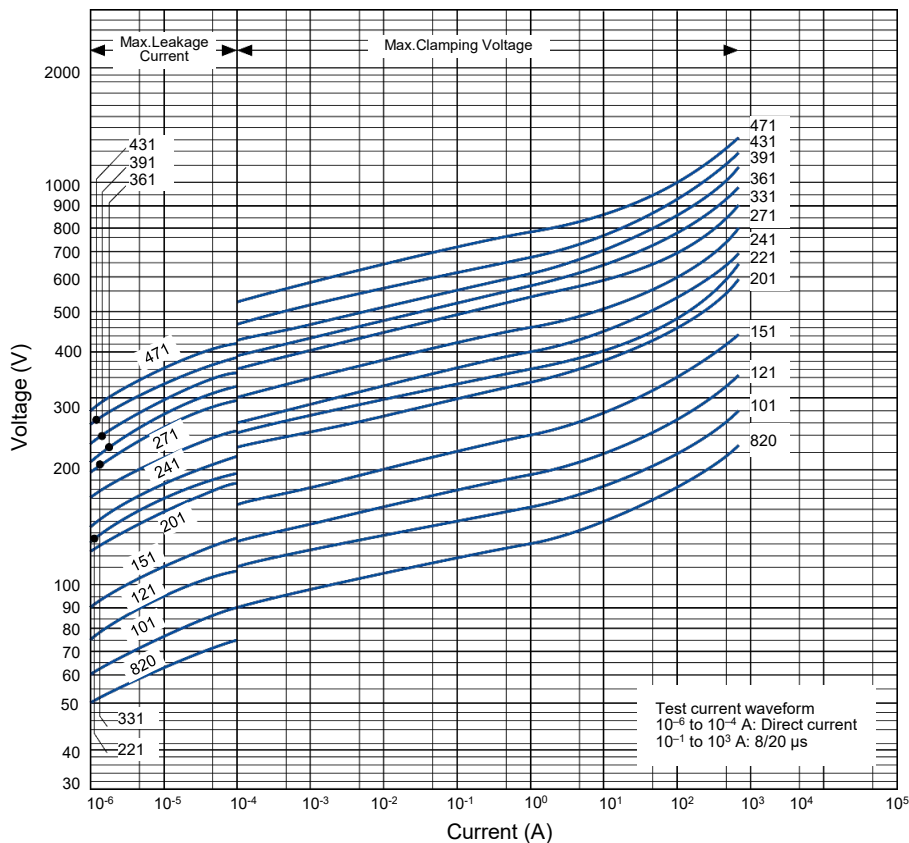

ERZV05D820 to ERZV05D471

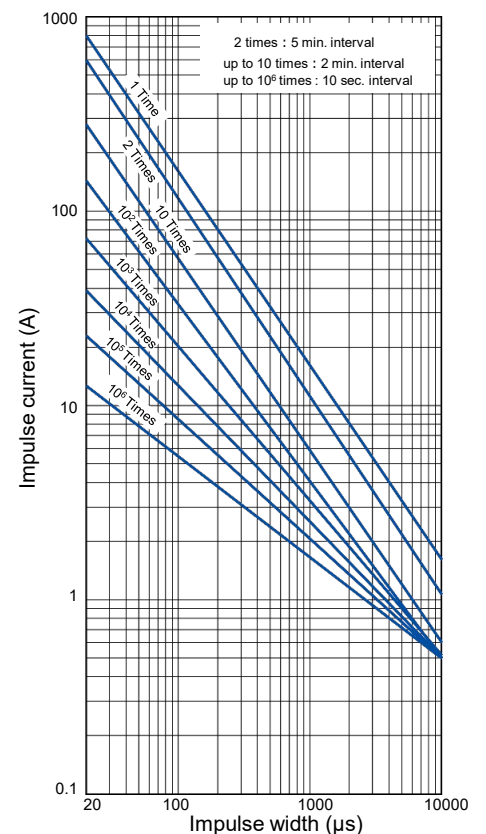



**Ratings and characteristics**

●Operating temperature range : -40 to 85 °C

●Storage temperature range : -40 to 125 °C

Part No.	Varistor voltage at 1 mA (V)	Maximum allowable voltage		Clamping voltage (max.) **Ip (V)	Rated power (W)	Maximum energy		Maximum peak current (8/20 μs)		Capacitance (max.) at 1 kHz (pF)
		AC rms (V)	DC (V)			(10/1000 μs) (J)	(2 ms) (J)	1 time (A)	2 times (A)	
	ERZV07D180	18(16 to 20)	11	14	36	0.02	1.1	0.9	500	250
ERZV07D220	22(20 to 24)	14	18	43	0.02	1.3	1.1	500	250	3600
ERZV07D270	27(24 to 30)	17	22	53	0.02	1.6	1.3	500	250	3400
ERZV07D330	33(30 to 36)	20	26	65	0.02	2.0	1.6	500	250	2900
ERZV07D390	39(35 to 43)	25	31	77	0.02	2.4	1.9	500	250	1600
ERZV07D470	47(42 to 52)	30	38	93	0.02	2.8	2.3	500	250	1550
ERZV07D560	56(50 to 62)	35	45	110	0.02	3.4	2.7	500	250	1500
ERZV07D680	68(61 to 75)	40	56	135	0.02	4.1	3.3	500	250	1200
ERZV07D820	82(74 to 90)	50	65	135	0.25	7	5	1750	1250	810
ERZV07D101	100(90 to 110)	60	85	165	0.25	8.5	6	1750	1250	700
ERZV07D121	120(108 to 132)	75	100	200	0.25	10	7	1750	1250	590
ERZV07D151	150(135 to 165)	95	125	250	0.25	13	9	1750	1250	500

★The following part numbers, kindly also consider corresponding, smaller E Series devices with better performance for their size. → [Please click here](#)

ERZV07D201	200(185 to 225)	130	170	340	0.25	17.5	12.5	1750	1250	200
ERZV07D221	220(198 to 242)	140	180	360	0.25	19	13.5	1750	1250	190
ERZV07D241	240(216 to 264)	150	200	395	0.25	21	15	1750	1250	170
ERZV07D271	270(247 to 303)	175	225	455	0.25	24	17	1750	1250	150
ERZV07D331	330(297 to 363)	210	270	545	0.25	28	20	1750	1250	130
ERZV07D361	360(324 to 396)	230	300	595	0.25	32	23	1750	1250	130
ERZV07D391	390(351 to 429)	250	320	650	0.25	35	25	1750	1250	130
ERZV07D431	430(387 to 473)	275	350	710	0.25	40	27.5	1750	1250	120
ERZV07D471	470(423 to 517)	300	385	775	0.25	42	30	1750	1250	100
ERZV07D511	510(459 to 561)	320	410	845	0.25	45	32	1750	1250	90*

\*Measured at 1 MHz    \*\*Ip Measuring current of clamping voltage 180 to 680 : 2.5 A, 820 to 511 : 10 A

**Dimensions in mm (not to scale)**

Unit : mm

Part No.	D max.	T max.	W±1.0	H max.	L±1.0
ERZV07D180	8.5	4.5	5.0	11.5	1.3
ERZV07D220	8.5	4.6	5.0	11.5	1.4
ERZV07D270	8.5	4.7	5.0	11.5	1.5
ERZV07D330	8.5	4.9	5.0	11.5	1.7
ERZV07D390	8.5	4.8	5.0	11.5	1.6
ERZV07D470	8.5	4.9	5.0	11.5	1.7
ERZV07D560	8.5	5.0	5.0	11.5	1.8
ERZV07D680	8.5	5.2	5.0	11.5	2.0
ERZV07D820	8.5	4.1	5.0	11.5	1.4
ERZV07D101	8.5	4.3	5.0	11.5	1.6
ERZV07D121	8.5	4.5	5.0	11.5	1.8
ERZV07D151	8.5	4.8	5.0	11.5	2.1

★The following part numbers, kindly also consider corresponding, smaller E Series devices with better performance for their size. → [Please click here](#)

ERZV07D201	8.5	4.4	5.0	11.5	1.7
ERZV07D221	8.5	4.5	5.0	11.5	1.8
ERZV07D241	8.5	4.6	5.0	11.5	1.9
ERZV07D271	8.5	4.8	5.0	11.5	2.1
ERZV07D331	8.5	5.1	5.0	11.5	2.4
ERZV07D361	8.5	5.3	5.0	11.5	2.5
ERZV07D391	8.5	5.4	5.0	11.5	2.7
ERZV07D431	8.5	5.6	5.0	11.5	2.9
ERZV07D471	8.5	5.8	5.0	11.5	3.1
ERZV07D511	8.5	6.0	5.0	11.5	3.3

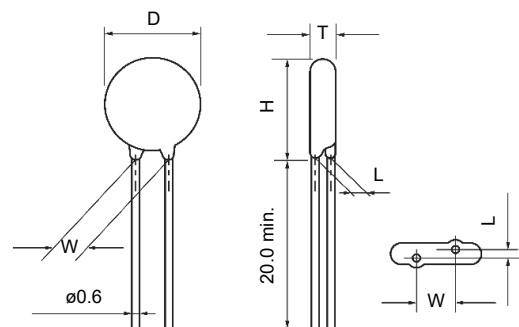



Typical characteristics

Voltage vs. Current

ERZV07D180 to ERZV07D680

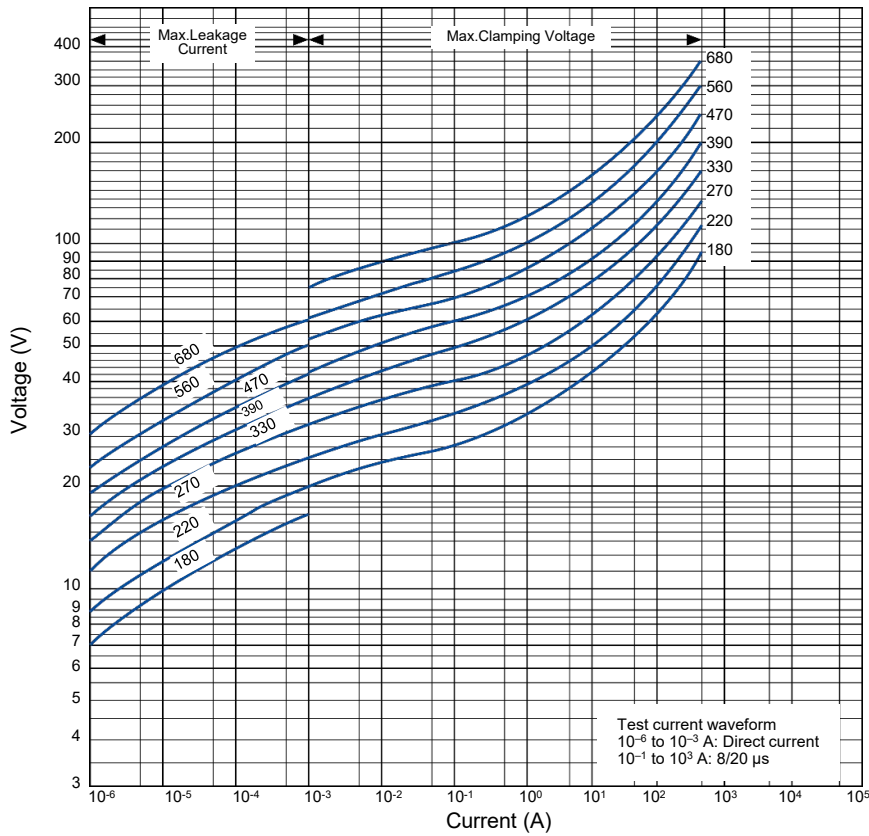

Impulse Derating (Relation between impulse width and impulse current multiple)

ERZV07D180 to ERZV07D680

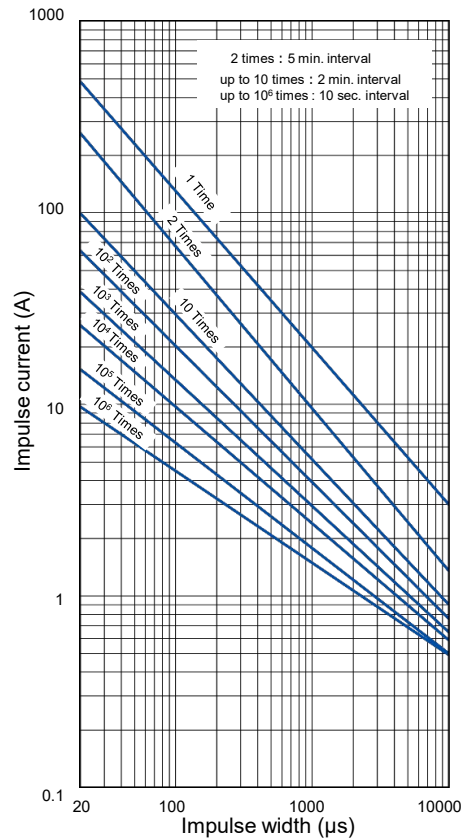

ERZV07D820 to ERZV07D511

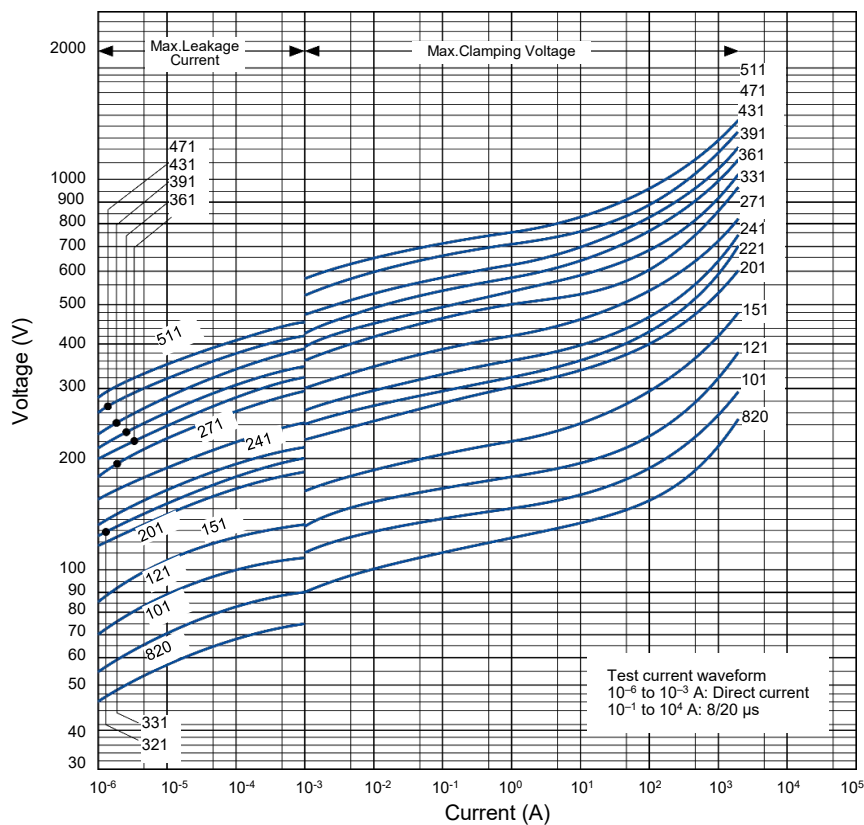

ERZV07D820 to ERZV07D511

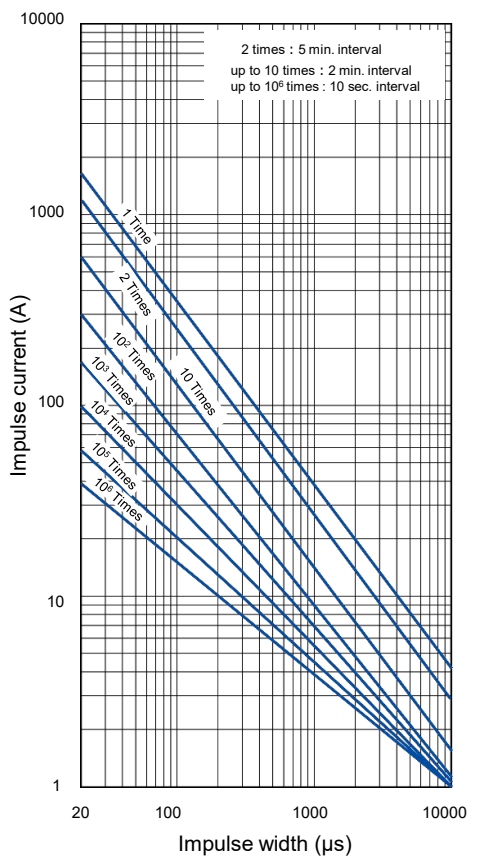

## Ratings and characteristics

●Operating temperature range : -40 to 85 °C

●Storage temperature range : -40 to 125 °C

Part No.	Varistor voltage at 1 mA (V)	Maximum allowable voltage		Clamping voltage (max.) **Ip (V)	Rated power (W)	Maximum energy		Maximum peak current (8/20 μs)		Capacitance (max.) at 1 kHz (pF)
		AC rms (V)	DC (V)			(10/1000 μs) (J)	(2 ms) (J)	1 time (A)	2 times (A)	
	ERZV09D180	18(16 to 20)	11	14	36	0.05	2.6	2.2	1000	500
ERZV09D220	22(20 to 24)	14	18	43	0.05	3.2	2.6	1000	500	11000
ERZV09D270	27(24 to 30)	17	22	53	0.05	3.9	3.2	1000	500	8000
ERZV09D330	33(30 to 36)	20	26	65	0.05	4.8	4.0	1000	500	6300
ERZV09D390	39(35 to 43)	25	31	77	0.05	5.6	4.7	1000	500	5200
ERZV09D470	47(42 to 52)	30	38	93	0.05	6.8	5.6	1000	500	4600
ERZV09D560	56(50 to 62)	35	45	110	0.05	8.1	6.7	1000	500	3750
ERZV09D680	68(61 to 75)	40	56	135	0.05	9.8	8.2	1000	500	2800
ERZV09D820	82(74 to 90)	50	65	135	0.4	14.0	10	3500	2500	2000
ERZV09D101	100(90 to 110)	60	85	165	0.4	17	12	3500	2500	1700
ERZV09D121	120(108 to 132)	75	100	200	0.4	20	14.5	3500	2500	1400
ERZV09D151	150(135 to 165)	95	125	250	0.4	25	18	3500	2500	1100

★The following part numbers, kindly also consider corresponding, smaller E Series devices with better performance for their size. → [Please click here](#)

ERZV09D201	200(185 to 225)	130	170	340	0.4	35	25	3500	2500	430
ERZV09D221	220(198 to 242)	140	180	360	0.4	39	27.5	3500	2500	410
ERZV09D241	240(216 to 264)	150	200	395	0.4	42	30	3500	2500	380
ERZV09D271	270(247 to 303)	175	225	455	0.4	49	35	3500	2500	350
ERZV09D331	330(297 to 363)	210	270	545	0.4	58	42	3500	2500	300
ERZV09D361	360(324 to 396)	230	300	595	0.4	65	45	3500	2500	300
ERZV09D391	390(351 to 429)	250	320	650	0.4	70	50	3500	2500	300
ERZV09D431	430(387 to 473)	275	350	710	0.4	80	55	3500	2500	270
ERZV09D471	470(423 to 517)	300	385	775	0.4	85	60	3500	2500	230
ERZV09D511	510(459 to 561)	320	410	845	0.4	92	67	3500	2500	210

\*Ip Measuring current of clamping voltage 180 to 680 : 5 A, 820 to 511 : 25 A

## Dimensions in mm (not to scale)

Part No.	Unit : mm				
	D max.	T max.	W±1.0	H max.	L±1.0
ERZV09D180	11.5	3.8	5.0	14.0	1.3
ERZV09D220	11.5	4.0	5.0	14.0	1.4
ERZV09D270	11.5	4.2	5.0	14.0	1.5
ERZV09D330	11.5	4.5	5.0	14.0	1.7
ERZV09D390	11.5	4.0	5.0	14.0	1.7
ERZV09D470	11.5	4.2	5.0	14.0	1.8
ERZV09D560	11.5	4.4	5.0	14.0	1.9
ERZV09D680	11.5	4.5	5.0	14.0	2.2
ERZV09D820	11.5	3.8	5.0	14.0	1.6
ERZV09D101	11.5	3.9	5.0	14.0	1.8
ERZV09D121	11.5	4.1	5.0	14.0	2.0
ERZV09D151	11.5	4.4	5.0	14.0	2.2

★The following part numbers, kindly also consider corresponding, smaller E Series devices with better performance for their size. → [Please click here](#)

ERZV09D201	11.5	4.1	5.0	14.0	1.7
ERZV09D221	11.5	4.2	5.0	14.0	1.8
ERZV09D241	11.5	4.3	5.0	14.0	1.9
ERZV09D271	11.5	4.5	5.0	14.0	2.0
ERZV09D331	11.5	4.8	5.0	14.0	2.3
ERZV09D361	11.5	5.0	5.0	14.0	2.5
ERZV09D391	11.5	5.1	5.0	14.0	2.6
ERZV09D431	11.5	5.3	5.0	14.0	2.8
ERZV09D471	11.5	5.6	5.0	14.0	3.1
ERZV09D511	11.5	5.8	5.0	14.0	3.2

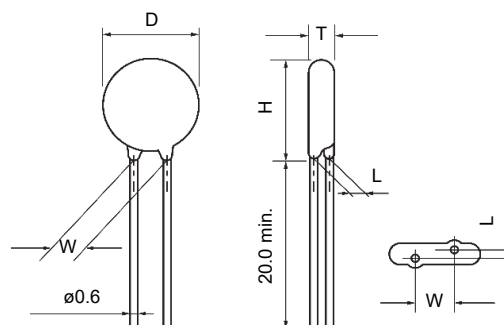

Typical characteristics

Voltage vs. Current

ERZV09D180 to ERZV09D680

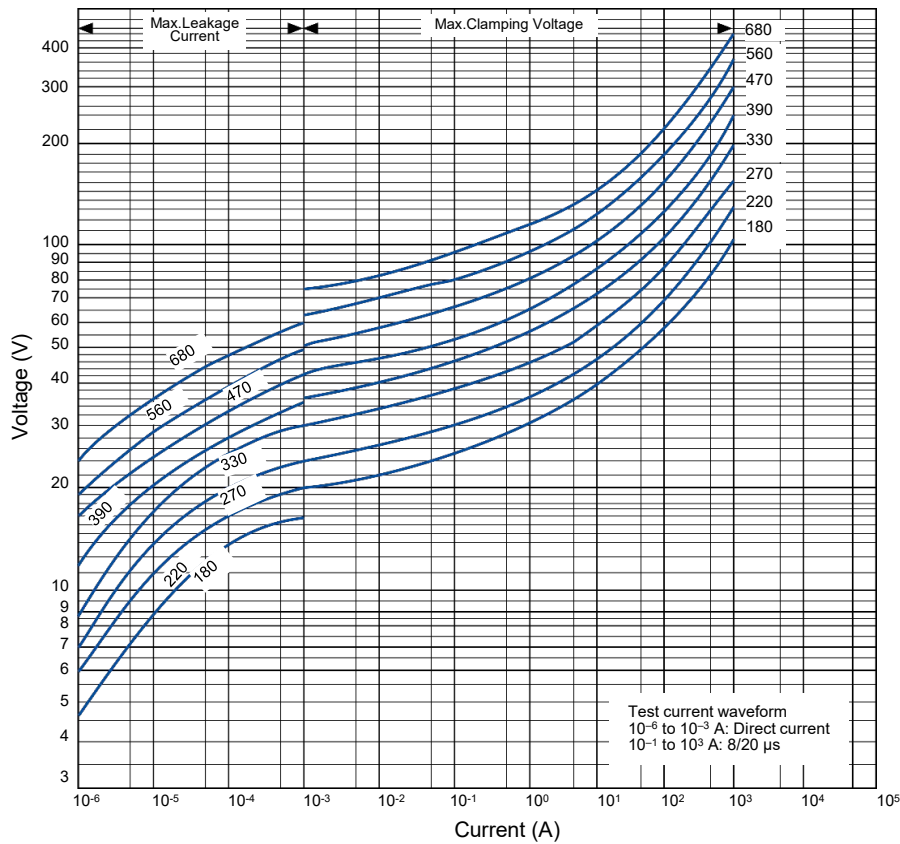

Impulse Derating (Relation between impulse width and impulse current multiple)

ERZV09D180 to ERZV09D680

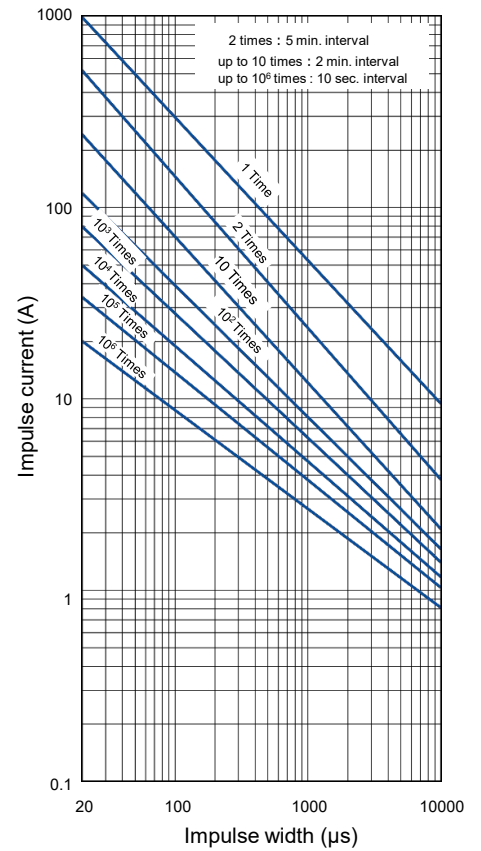

ERZV09D820 to ERZV09D511

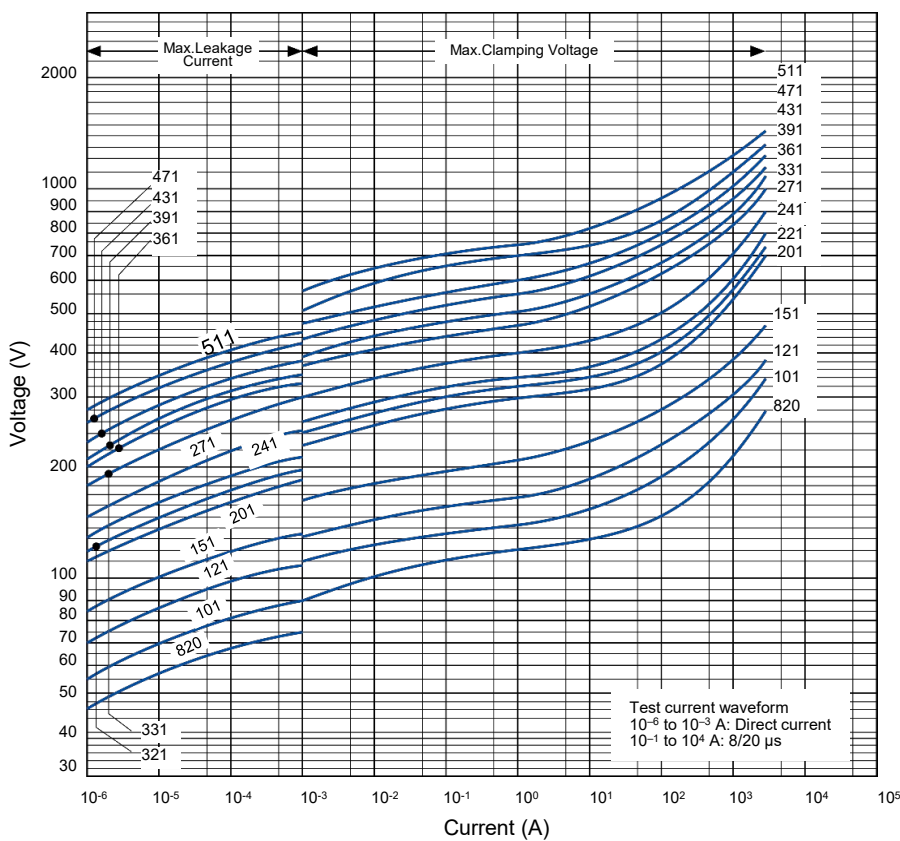

ERZV09D820 to ERZV09D511

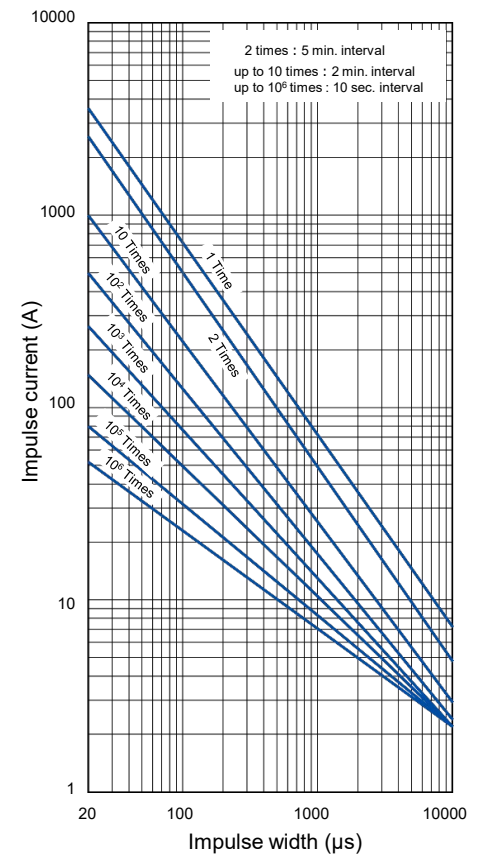

## Ratings and characteristics

●Operating temperature range : -40 to 85 °C

●Storage temperature range : -40 to 125 °C

Part No.	Varistor voltage at 1 mA (V)	Maximum allowable voltage		Clamping voltage (max.) **Ip (V)	Rated power (W)	Maximum energy		Maximum peak current (8/20 μs)		Capacitance (max.) at 1 kHz (pF)
		AC rms (V)	DC (V)			(10/1000 μs) (J)	(2 ms) (J)	1 time (A)	2 times (A)	
	ERZV10D180	18(16 to 20)	11	14	36	0.05	2.6	2.2	1000	500
ERZV10D220	22(20 to 24)	14	18	43	0.05	3.2	2.6	1000	500	11000
ERZV10D270	27(24 to 30)	17	22	53	0.05	3.9	3.2	1000	500	8000
ERZV10D330	33(30 to 36)	20	26	65	0.05	4.8	4.0	1000	500	6300
ERZV10D390	39(35 to 43)	25	31	77	0.05	5.6	4.7	1000	500	5200
ERZV10D470	47(42 to 52)	30	38	93	0.05	6.8	5.6	1000	500	4600
ERZV10D560	56(50 to 62)	35	45	110	0.05	8.1	6.7	1000	500	3750
ERZV10D680	68(61 to 75)	40	56	135	0.05	9.8	8.2	1000	500	2800
ERZV10D820	82(74 to 90)	50	65	135	0.4	14	10	3500	2500	2000
ERZV10D101	100(90 to 110)	60	85	165	0.4	17	12	3500	2500	1700
ERZV10D121	120(108 to 132)	75	100	200	0.4	20	14.5	3500	2500	1400
ERZV10D151	150(135 to 165)	95	125	250	0.4	25	18	3500	2500	1100

★The following part numbers, kindly also consider corresponding, smaller E Series devices with better performance for their size. → [Please click here](#)

ERZV10D201	200(185 to 225)	130	170	340	0.4	35	25	3500	2500	430
ERZV10D221	220(198 to 242)	140	180	360	0.4	39	27.5	3500	2500	410
ERZV10D241	240(216 to 264)	150	200	395	0.4	42	30	3500	2500	380
ERZV10D271	270(247 to 303)	175	225	455	0.4	49	35	3500	2500	350
ERZV10D331	330(297 to 363)	210	270	545	0.4	58	42	3500	2500	300
ERZV10D361	360(324 to 396)	230	300	595	0.4	65	45	3500	2500	300
ERZV10D391	390(351 to 429)	250	320	650	0.4	70	50	3500	2500	300
ERZV10D431	430(387 to 473)	275	350	710	0.4	80	55	3500	2500	270
ERZV10D471	470(423 to 517)	300	385	775	0.4	85	60	3500	2500	230
ERZV10D511	510(459 to 561)	320	410	845	0.4	92	67	3500	2500	210
ERZV10D561	560(504 to 616)	350	450	930	0.4	92	67	3500	2500	200
ERZV10D621	620(558 to 682)	385	505	1025	0.4	92	67	3500	2500	190
ERZV10D681	680(612 to 748)	420	560	1120	0.4	92	67	3500	2500	170
ERZV10D751	750(675 to 825)	460	615	1240	0.4	100	70	3500	2500	160
ERZV10D821	820(738 to 902)	510	670	1355	0.4	110	80	3500	2500	140
ERZV10D911	910(819 to 1001)	550	745	1500	0.4	130	90	3500	2500	120
ERZV10D102	1000(900 to 1100)	625	825	1650	0.4	140	100	3500	2500	110
ERZV10D112	1100(990 to 1210)	680	895	1815	0.4	155	110	3500	2500	110
ERZV10D182CS	1800(1700 to 1980)	1000	1465	2970	0.4*	247	183***	3500	2500	***70*

\*Measured at 1 MHz    \*\*Ip Measuring current of clamping voltage 180 to 680 : 5 A, 820 to 182 : 25 A

**Dimensions in mm (not to scale)**

Unit : mm

Part No.	D max.	T max.	W±1.0	H max.	L±1.0
ERZV10D180	11.5	4.6	7.5	14.5	1.3
ERZV10D220	11.5	4.7	7.5	14.5	1.4
ERZV10D270	11.5	4.8	7.5	14.5	1.5
ERZV10D330	11.5	5.0	7.5	14.5	1.7
ERZV10D390	11.5	4.9	7.5	14.5	1.6
ERZV10D470	11.5	5.0	7.5	14.5	1.7
ERZV10D560	11.5	5.1	7.5	14.5	1.8
ERZV10D680	11.5	5.3	7.5	14.5	2.0
ERZV10D820	11.5	4.5	7.5	14.5	1.6
ERZV10D101	11.5	4.7	7.5	14.5	1.8
ERZV10D121	11.5	4.9	7.5	14.5	2.0
ERZV10D151	11.5	5.2	7.5	14.5	2.3

★ The following part numbers, kindly also consider corresponding, smaller E Series devices with better performance for their size. → [Please click here](#)

ERZV10D201	11.5	4.8	7.5	14.5	1.9
ERZV10D221	11.5	4.9	7.5	14.5	2.0
ERZV10D241	11.5	5.0	7.5	14.5	2.1
ERZV10D271	11.5	5.2	7.5	14.5	2.3
ERZV10D331	11.5	5.5	7.5	14.5	2.6
ERZV10D361	11.5	5.7	7.5	14.5	2.8
ERZV10D391	11.5	5.8	7.5	14.5	2.9
ERZV10D431	11.5	6.0	7.5	14.5	3.1
ERZV10D471	11.5	6.2	7.5	14.5	3.3
ERZV10D511	11.5	6.4	7.5	14.5	3.5
ERZV10D561	12.5	6.7	7.5	15.5	3.8
ERZV10D621	12.5	7.1	7.5	15.5	4.2
ERZV10D681	12.5	7.4	7.5	15.5	4.5
ERZV10D751	12.5	7.8	7.5	15.5	4.9
ERZV10D821	12.5	8.1	7.5	15.5	5.2
ERZV10D911	12.5	8.6	7.5	15.5	5.7
ERZV10D102	12.5	9.1	7.5	15.5	6.2
ERZV10D112	12.5	9.7	7.5	15.5	6.8

ERZV10D182CS	13.5	14.4	11.0*	16.5	10.0 (±1.5)
--------------	------	------	-------	------	-------------

\* W<sub>2</sub>

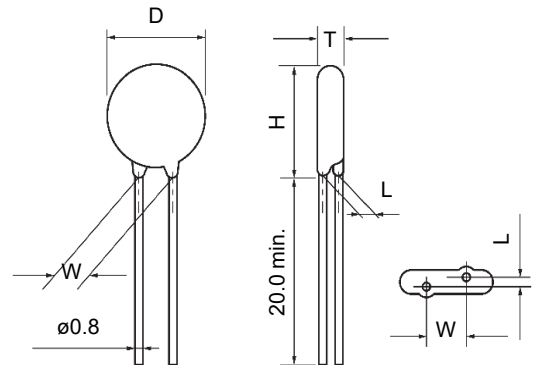

(ERZV10D182CS)

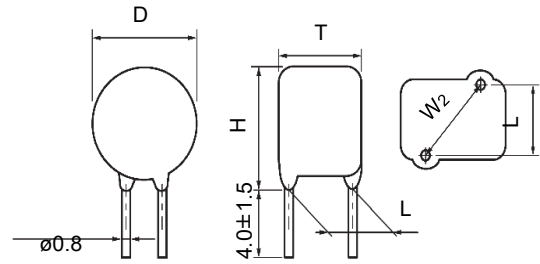

**Typical characteristics**

**Voltage vs. Current**

ERZV10D180 to ERZV10D680

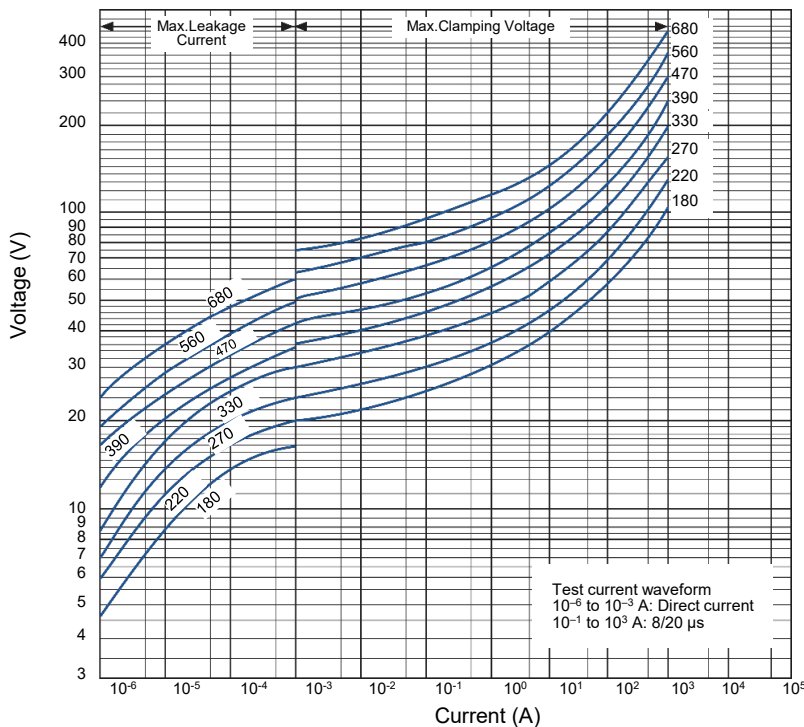

**Impulse Derating** (Relation between impulse width and impulse current multiple)

ERZV10D180 to ERZV10D680

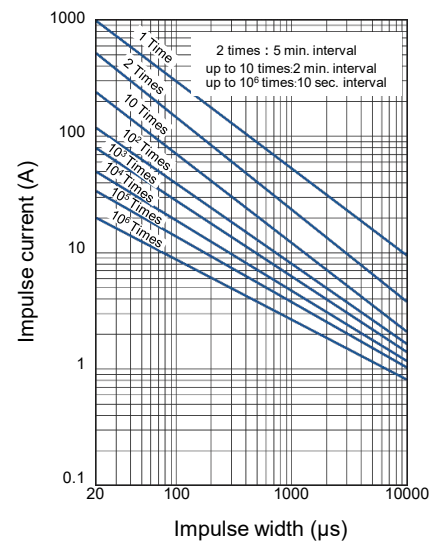



Typical characteristics

Voltage vs. Current

ERZV10D820 to ERZV10D511

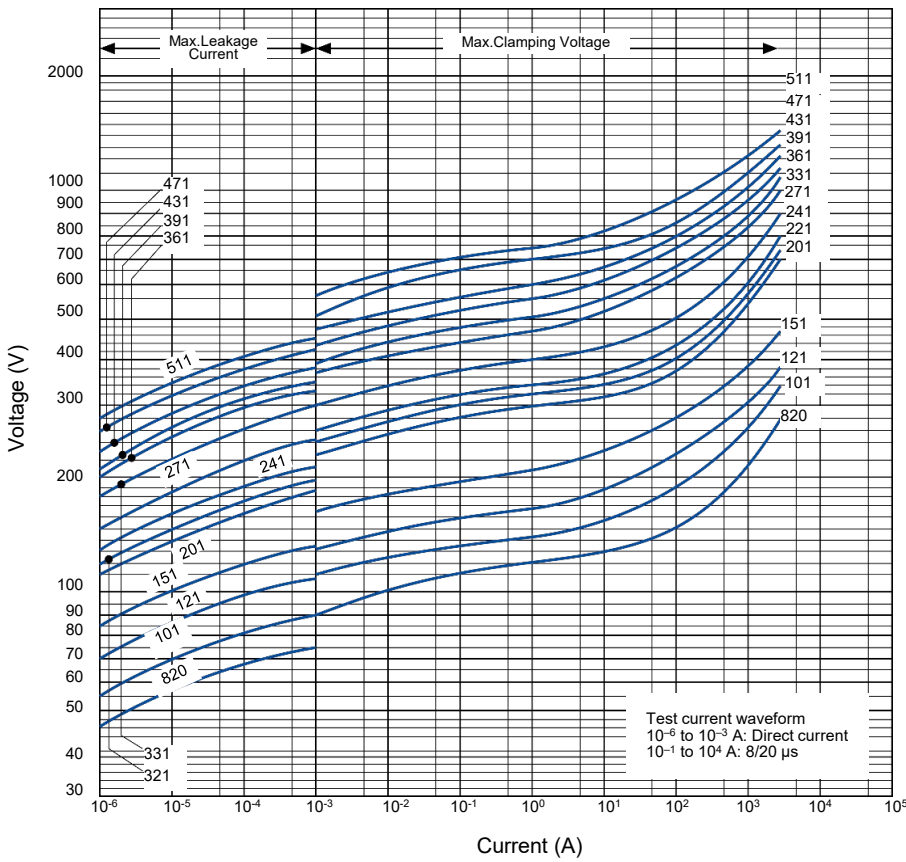

Impulse Derating (Relation between impulse width and impulse current multiple)

ERZV10D820 to ERZV10D511

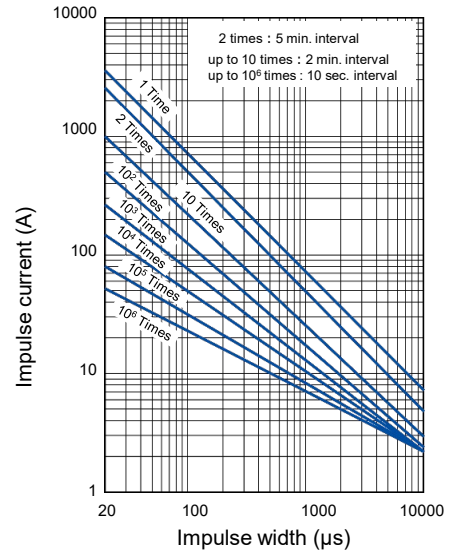

ERZV10D561 to ERZV10D112

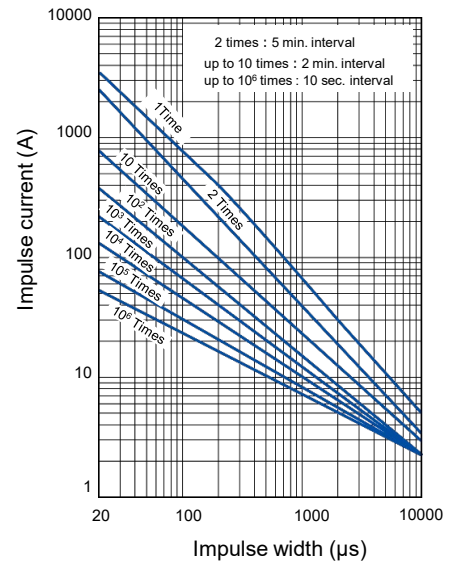

ERZV10D561 to ERZV10D182CS

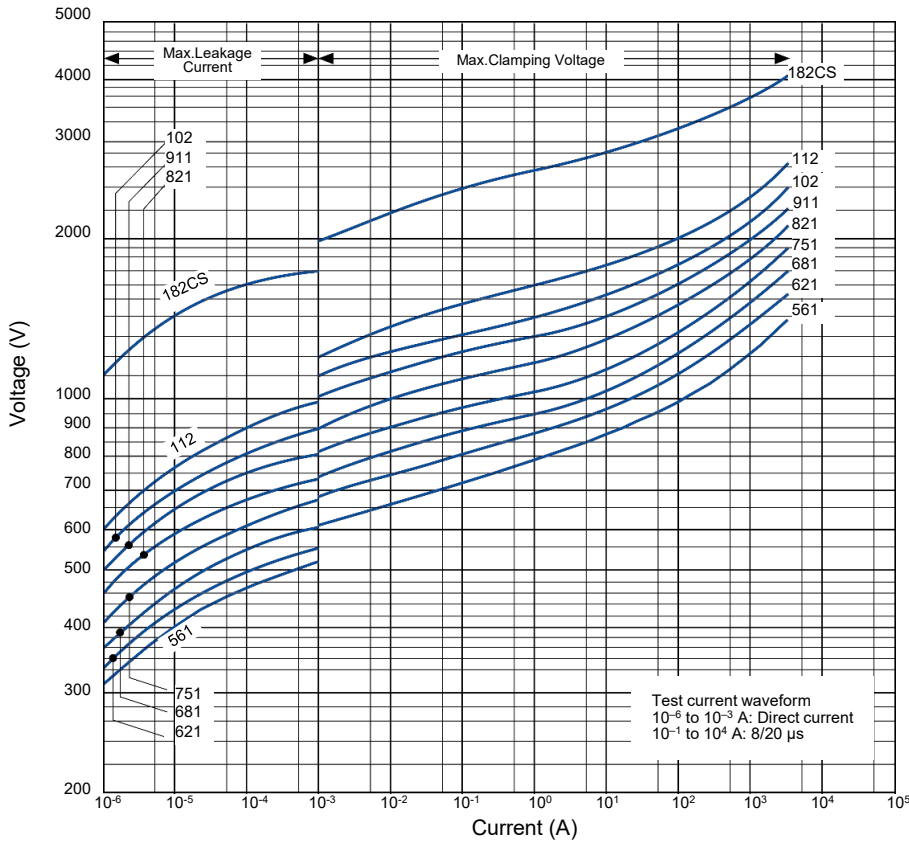

ERZV10D182CS

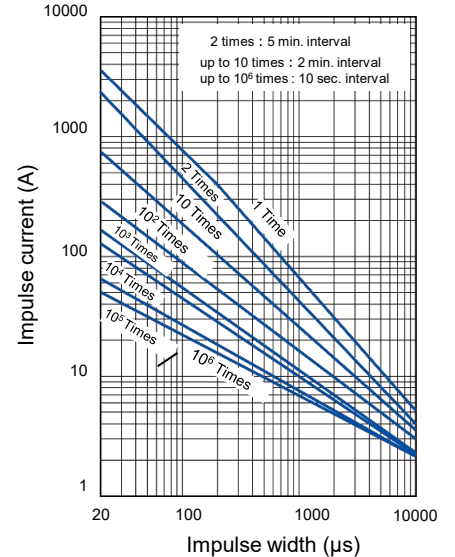

## Ratings and characteristics

●Operating temperature range : -40 to 85 °C

●Storage temperature range : -40 to 125 °C

Part No.	Varistor voltage at 1 mA (V)	Maximum allowable voltage		Clamping voltage (max.) **Ip (V)	Rated power (W)	Maximum energy		Maximum peak current (8/20 μs)		Capacitance (max.) at 1 kHz (pF)
		AC rms (V)	DC (V)			(10/1000 μs) (J)	(2 ms) (J)	1 time (A)	2 times (A)	
	ERZV14D180	18(16 to 20)	11	14	36	0.1	5.2	4.3	2000	1000
ERZV14D220	22(20 to 24)	14	18	43	0.1	6.3	5.3	2000	1000	20000
ERZV14D270	27(24 to 30)	17	22	53	0.1	7.8	6.5	2000	1000	16000
ERZV14D330	33(30 to 36)	20	26	65	0.1	9.5	7.9	2000	1000	12200
ERZV14D390	39(35 to 43)	25	31	77	0.1	11	9.4	2000	1000	7000
ERZV14D470	47(42 to 52)	30	38	93	0.1	14	11	2000	1000	6750
ERZV14D560	56(50 to 62)	35	45	110	0.1	16	13	2000	1000	6500
ERZV14D680	68(61 to 75)	40	56	135	0.1	20	16	2000	1000	5500
ERZV14D820	82(74 to 90)	50	65	135	0.6	28	20	6000	5000	3700
ERZV14D101	100(90 to 110)	60	85	165	0.6	35	25	6000	5000	3200
ERZV14D121	120(108 to 132)	75	100	200	0.6	42	30	6000	5000	2700
ERZV14D151	150(135 to 165)	95	125	250	0.6	53	37.5	6000	5000	2200

★The following part numbers, kindly also consider corresponding, smaller E Series devices with better performance for their size. → [Please click here](#)

ERZV14D201	200(185 to 225)	130	170	340	0.6	70	50	6000	5000	770
ERZV14D221	220(198 to 242)	140	180	360	0.6	78	55	6000	5000	740
ERZV14D241	240(216 to 264)	150	200	395	0.6	84	60	6000	5000	700
ERZV14D271	270(247 to 303)	175	225	455	0.6	99	70	6000	5000	640
ERZV14D331	330(297 to 363)	210	270	545	0.6	115	80	6000	4500	580
ERZV14D361	360(324 to 396)	230	300	595	0.6	130	90	6000	4500	540
ERZV14D391	390(351 to 429)	250	320	650	0.6	140	100	6000	4500	500
ERZV14D431	430(387 to 473)	275	350	710	0.6	155	110	6000	4500	450
ERZV14D471	470(423 to 517)	300	385	775	0.6	175	125	6000	4500	400
ERZV14D511	510(459 to 561)	320	410	845	0.6	190	136	6000	4500	350
ERZV14D561	560(504 to 616)	350	450	930	0.6	190	136	5000	4500	340
ERZV14D621	620(558 to 682)	385	505	1025	0.6	190	136	5000	4500	330
ERZV14D681	680(612 to 748)	420	560	1120	0.6	190	136	5000	4500	320
ERZV14D751	750(675 to 825)	460	615	1240	0.6	210	150	5000	4500	310
ERZV14D821	820(738 to 902)	510	670	1355	0.6	235	165	5000	4500	280
ERZV14D911	910(819 to 1001)	550	745	1500	0.6	255	180	5000	4500	250
ERZV14D102	1000(900 to 1100)	625	825	1650	0.6	280	200	5000	4500	230
ERZV14D112	1100(990 to 1210)	680	895	1815	0.6	310	220	5000	4500	210
ERZV14D182CS	1800(1700 to 1980)	1000	1465	2970	0.6	510	360	5000	4500	120

\*Ip Measuring current of clamping voltage 180 to 680 : 10 A, 820 to 182 : 50 A



**Dimensions in mm (not to scale)**

Unit : mm

Part No.	D max.	T max.	W±1.0	H max.	L±1.0
ERZV14D180	15.5	4.6	7.5	18.5	1.3
ERZV14D220	15.5	4.7	7.5	18.5	1.4
ERZV14D270	15.5	4.8	7.5	18.5	1.5
ERZV14D330	15.5	5.0	7.5	18.5	1.7
ERZV14D390	15.5	4.9	7.5	18.5	1.6
ERZV14D470	15.5	5.0	7.5	18.5	1.7
ERZV14D560	15.5	5.1	7.5	18.5	1.8
ERZV14D680	15.5	5.3	7.5	18.5	2.0
ERZV14D820	15.5	4.5	7.5	18.5	1.6
ERZV14D101	15.5	4.7	7.5	18.5	1.8
ERZV14D121	15.5	4.9	7.5	18.5	2.0
ERZV14D151	15.5	5.2	7.5	18.5	2.3

★ The following part numbers, kindly also consider corresponding, smaller E Series devices with better performance for their size. → [Please click here](#)

ERZV14D201	15.5	4.8	7.5	18.5	1.9
ERZV14D221	15.5	4.9	7.5	18.5	2.0
ERZV14D241	15.5	5.0	7.5	18.5	2.1
ERZV14D271	15.5	5.2	7.5	18.5	2.3
ERZV14D331	15.5	5.5	7.5	18.5	2.6
ERZV14D361	15.5	5.7	7.5	18.5	2.8
ERZV14D391	15.5	5.8	7.5	18.5	2.9
ERZV14D431	15.5	6.0	7.5	18.5	3.1
ERZV14D471	15.5	6.2	7.5	18.5	3.3
ERZV14D511	15.5	6.4	7.5	18.5	3.5
ERZV14D561	16.0	6.7	7.5	19.0	3.8
ERZV14D621	16.0	7.1	7.5	19.0	4.2
ERZV14D681	16.0	7.4	7.5	19.0	4.5
ERZV14D751	16.0	7.8	7.5	19.0	4.9
ERZV14D821	16.0	8.1	7.5	19.0	5.2
ERZV14D911	16.0	8.6	7.5	19.0	5.7
ERZV14D102	16.0	9.1	7.5	19.0	6.2
ERZV14D112	16.0	9.7	7.5	19.0	6.8

ERZV14D182CS	17.0	14.4*	15.0*	20.5	10.5 (±2.0)
--------------	------	-------	-------	------	-------------

\* : W<sub>2</sub>

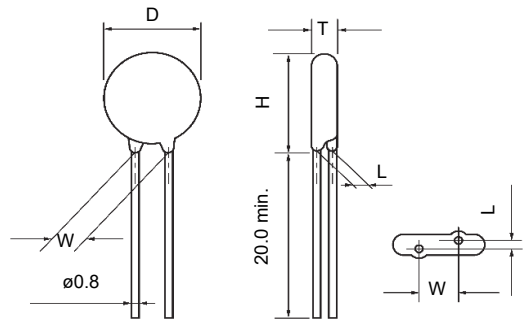

(ERZV14D182CS)

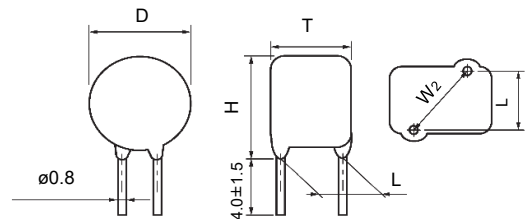

**Typical characteristics**

**Voltage vs. Current**

ERZV14D180 to ERZV14D680

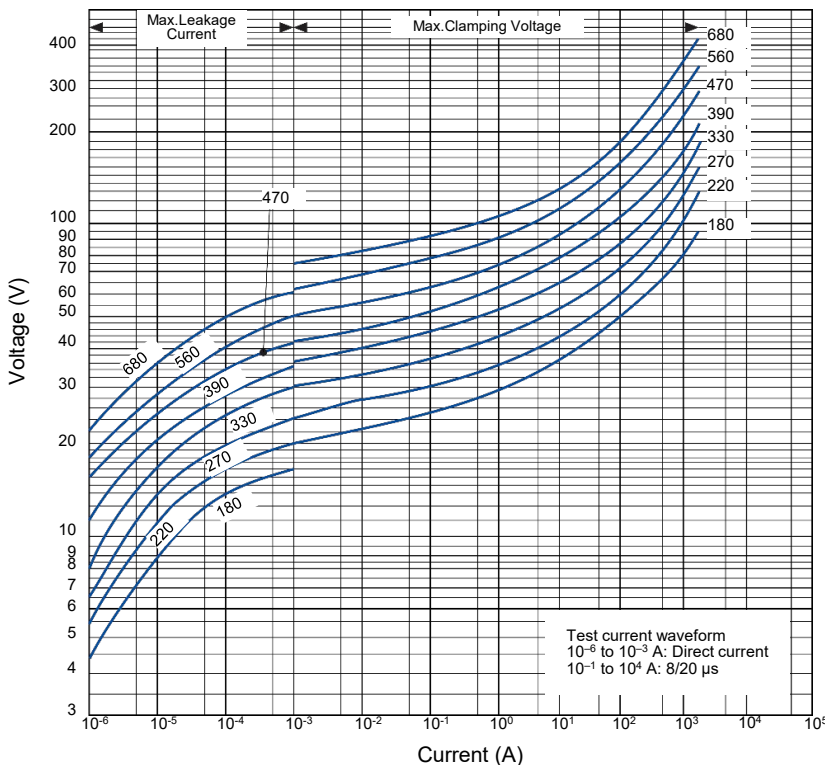

**Impulse Derating** (Relation between impulse width and impulse current multiple)  
ERZV14D180 to ERZV14D680

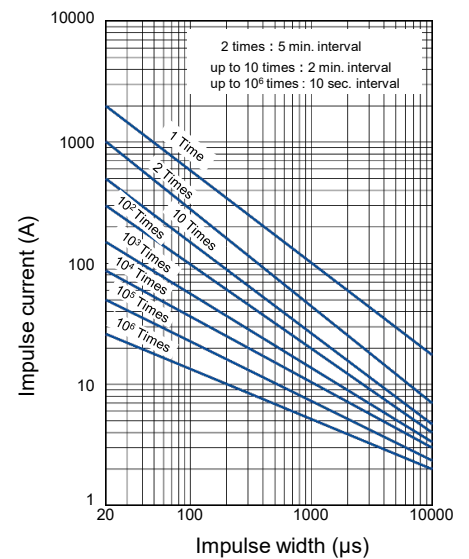

Typical characteristics

Voltage vs. Current

ERZV14D820 to ERZV14D511

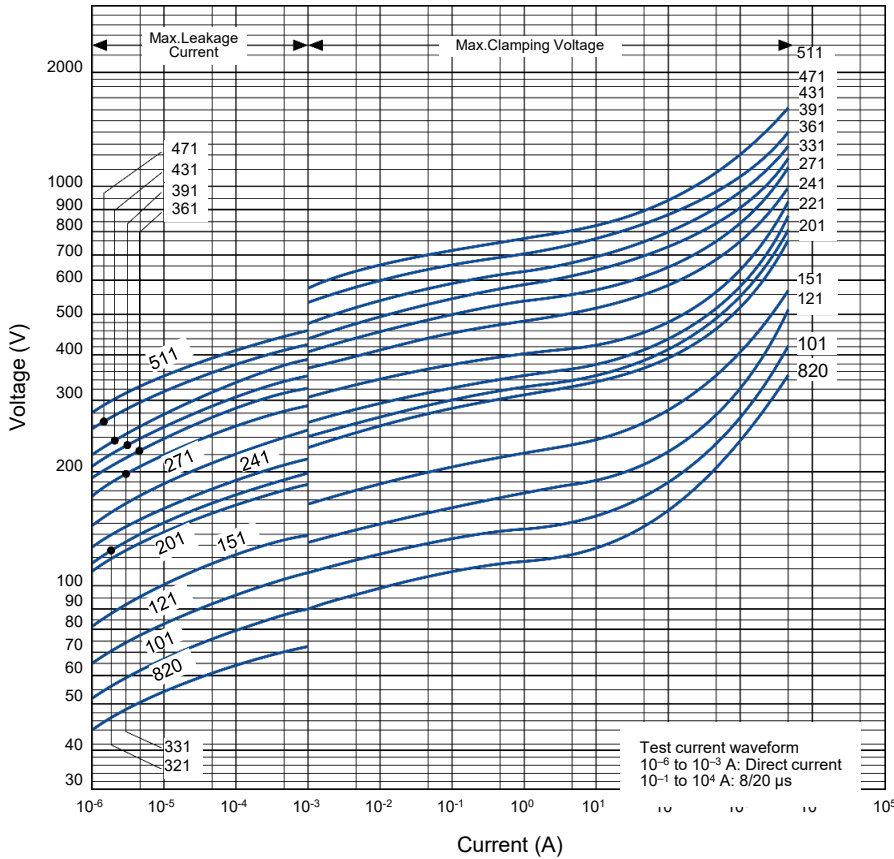

ERZV14D561 to ERZV14D182CS

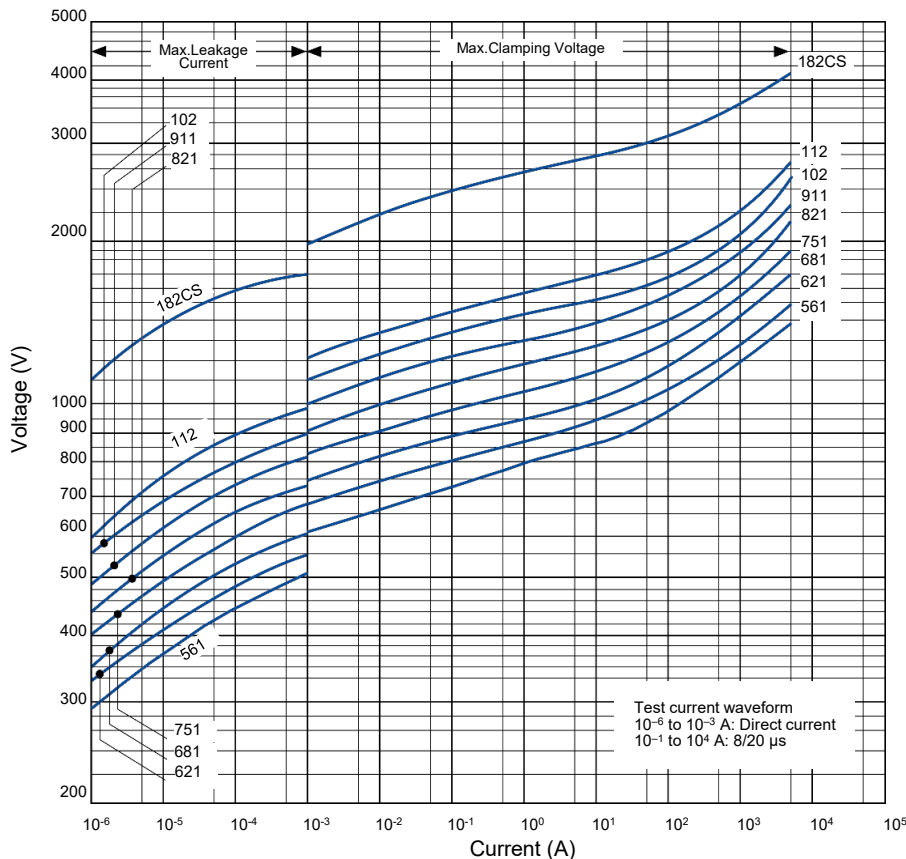

Impulse Derating (Relation between impulse width and impulse current multiple)

ERZV14D820 to ERZV14D511

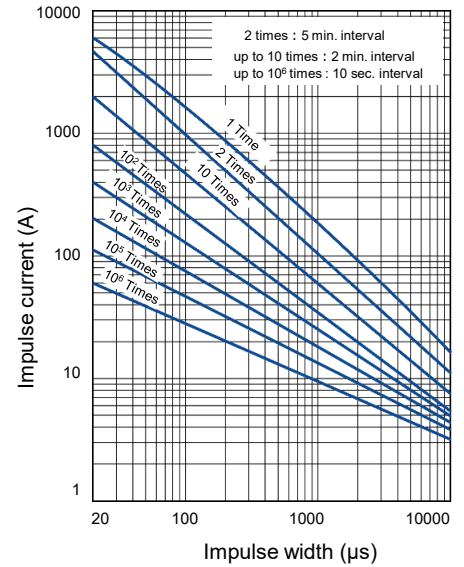

ERZV14D561 to ERZV14D112

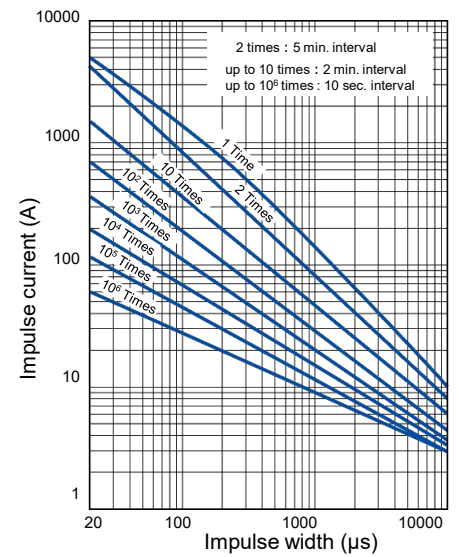

ERZV14D182CS

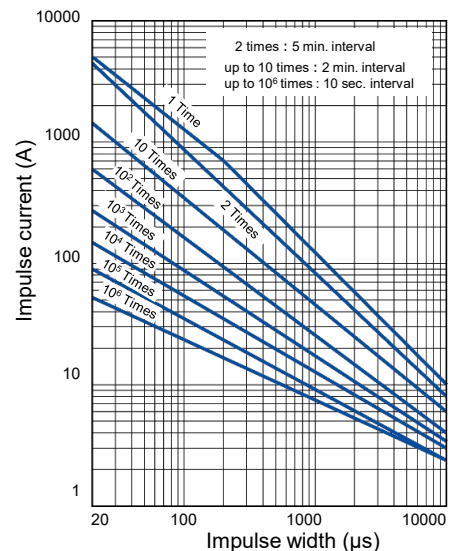

## Ratings and characteristics

●Operating temperature range : -40 to 85 °C

●Storage temperature range : -40 to 125 °C

Part No.	Varistor voltage at 1 mA	Maximum allowable voltage		Clamping voltage (max.) **Ip	Rated power	Maximum energy		Maximum peak current (8/20 μs)		Capacitance (max.) at 1 kHz
		AC rms (V)	DC (V)			(10/1000 μs)	(2 ms)	1 time	2 times	
	(V)	(V)	(V)	(W)	(J)	(J)	(A)	(A)	(pF)	
ERZV20D180	18(16 to 20)	11	14	36	0.2	13	12	3000	2000	40000
ERZV20D220	22(20 to 24)	14	18	43	0.2	16	14	3000	2000	30000
ERZV20D270	27(24 to 30)	17	22	53	0.2	19	17	3000	2000	24500
ERZV20D330	33(30 to 36)	20	26	65	0.2	24	21	3000	2000	20000
ERZV20D390	39(35 to 43)	25	31	77	0.2	28	25	3000	2000	13800
ERZV20D470	47(42 to 52)	30	38	93	0.2	34	30	3000	2000	13500
ERZV20D560	56(50 to 62)	35	45	110	0.2	41	36	3000	2000	12200
ERZV20D680	68(61 to 75)	40	56	135	0.2	49	44	3000	2000	11500
ERZV20D820	82(74 to 90)	50	65	135	1.0	56	40	10000	7000	7500
ERZV20D101	100(90 to 110)	60	85	165	1.0	70	50	10000	7000	6500
ERZV20D121	120(108 to 132)	75	100	200	1.0	85	60	10000	7000	5500
ERZV20D151	150(135 to 165)	95	125	250	1.0	106	75	10000	7000	4500

★The following part numbers, kindly also consider corresponding, smaller E Series devices with better performance for their size. → [Please click here](#)

ERZV20D201	200(185 to 225)	130	170	340	1.0	140	100	10000	7000	1700
ERZV20D221	220(198 to 242)	140	180	360	1.0	155	110	10000	7000	1600
ERZV20D241	240(216 to 264)	150	200	395	1.0	168	120	10000	7000	1500
ERZV20D271	270(247 to 303)	175	225	455	1.0	190	135	10000	7000	1300
ERZV20D331	330(297 to 363)	210	270	545	1.0	228	160	10000	6500	1100
ERZV20D361	360(324 to 396)	230	300	595	1.0	255	180	10000	6500	1100
ERZV20D391	390(351 to 429)	250	320	650	1.0	275	195	10000	6500	1100
ERZV20D431	430(387 to 473)	275	350	710	1.0	303	215	10000	6500	1000
ERZV20D471	470(423 to 517)	300	385	775	1.0	350	250	10000	6500	900
ERZV20D511	510(459 to 561)	320	410	845	1.0	382	273	10000	6500	800
ERZV20D561	560(504 to 616)	350	450	930	1.0	382	273	7500	6500	750
ERZV20D621	620(558 to 682)	385	505	1025	1.0	382	273	7500	6500	700
ERZV20D681	680(612 to 748)	420	560	1120	1.0	382	273	7500	6500	650
ERZV20D751	750(675 to 825)	460	615	1240	1.0	420	300	7500	6500	600
ERZV20D821	820(738 to 902)	510	670	1355	1.0	460	325	7500	6500	530
ERZV20D911	910(819 to 1001)	550	745	1500	1.0	510	360	7500	6500	500
ERZV20D102	1000(900 to 1100)	625	825	1650	1.0	565	400	7500	6500	450
ERZV20D112	1100(990 to 1210)	680	895	1815	1.0	620	440	7500	6500	400
ERZV20D182	1800(1700 to 1980)	1000	1465	2970	1.0	1020	720	7500	6500	250

\*Ip Measuring current of clamping voltage 180 to 680 : 20 A, 820 to 182 : 100 A

**Dimensions in mm (not to scale)**

Part No.	D max.	T max.	W±1.0	H max.	L±1.0
ERZV20D180	21.5	5.1	10.0	24.5	1.5
ERZV20D220	21.5	5.2	10.0	24.5	1.6
ERZV20D270	21.5	5.3	10.0	24.5	1.7
ERZV20D330	21.5	5.5	10.0	24.5	1.9
ERZV20D390	21.5	5.5	10.0	24.5	1.9
ERZV20D470	21.5	5.6	10.0	24.5	2.0
ERZV20D560	21.5	5.7	10.0	24.5	2.1
ERZV20D680	21.5	5.8	10.0	24.5	2.2
ERZV20D820	21.5	4.9	10.0	24.5	1.8
ERZV20D101	21.5	5.1	10.0	24.5	2.0
ERZV20D121	21.5	5.3	10.0	24.5	2.2
ERZV20D151	21.5	5.6	10.0	24.5	2.5

★ The following part numbers, kindly also consider corresponding, smaller E Series devices with better performance for their size. → [Please click here](#)

ERZV20D201	21.5	5.2	10.0	24.5	2.1
ERZV20D221	21.5	5.3	10.0	24.5	2.2
ERZV20D241	21.5	5.4	10.0	24.5	2.3
ERZV20D271	21.5	5.6	10.0	24.5	2.5
ERZV20D331	21.5	5.9	10.0	24.5	2.8
ERZV20D361	21.5	6.1	10.0	24.5	3.0
ERZV20D391	21.5	6.2	10.0	24.5	3.1
ERZV20D431	21.5	6.4	10.0	24.5	3.3
ERZV20D471	21.5	6.6	10.0	24.5	3.5
ERZV20D511	21.5	6.8	10.0	24.5	3.7
ERZV20D561	22.5	7.1	10.0	25.5	4.2
ERZV20D621	22.5	7.5	10.0	25.5	4.4
ERZV20D681	22.5	7.8	10.0	25.5	4.7
ERZV20D751	22.5	8.2	10.0	25.5	5.1
ERZV20D821	22.5	8.5	10.0	25.5	5.4
ERZV20D911	22.5	9.0	10.0	25.5	5.9
ERZV20D102	22.5	9.5	10.0	25.5	6.4
ERZV20D112	22.5	10.1	10.0	25.5	7.0

ERZV20D182	23.5	14.8	15.0*	28.0	10.7 (±2.0)
------------	------	------	-------	------	-------------

\*: W<sub>2</sub>

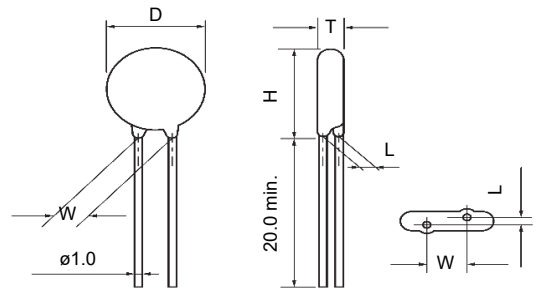

(ERZV20D182)

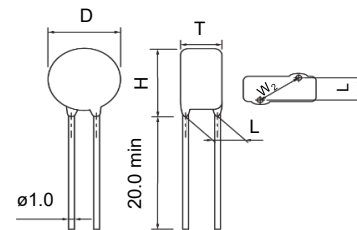

**Typical characteristics**

**Voltage vs. Current+B47:AZ78+B47:AX74**

ERZV20D180 to ERZV20D680

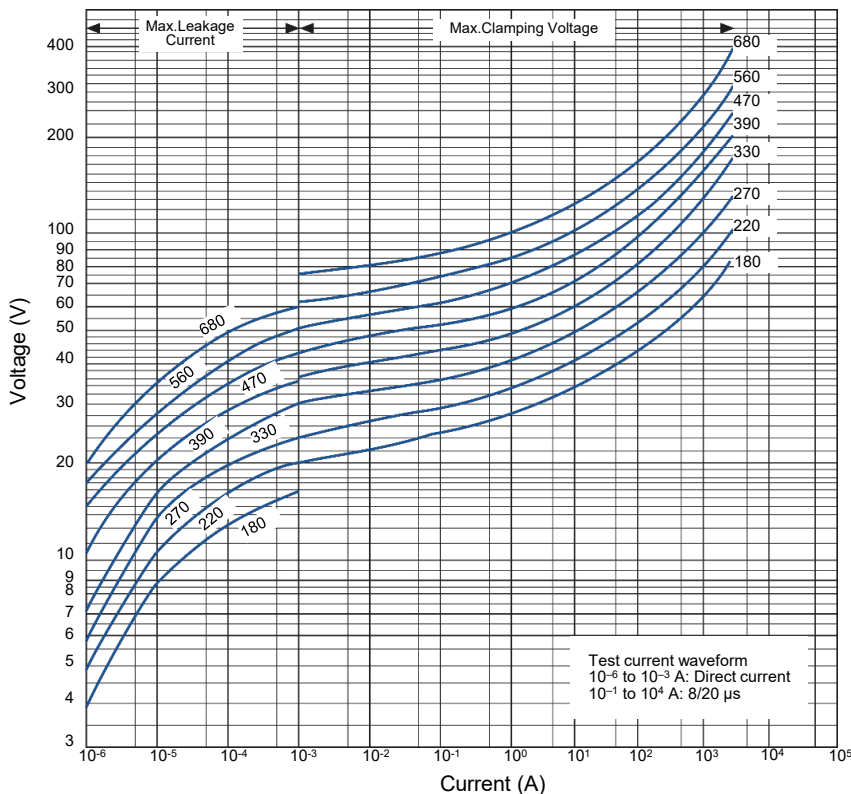

**Impulse Derating** (Relation between impulse width and impulse current multiple)

ERZV20D180 to ERZV20D680

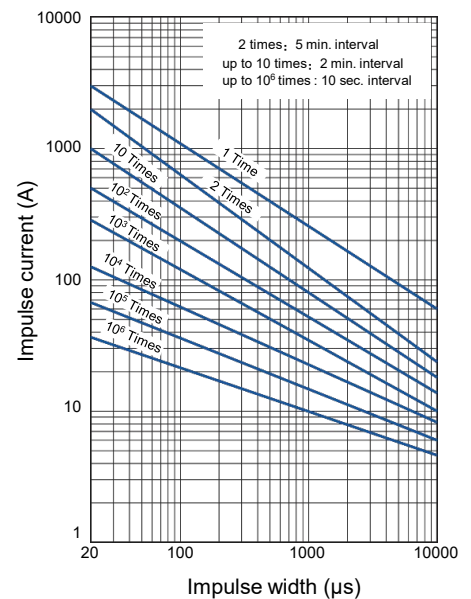

Typical characteristics

Voltage vs. Current

ERZV20D820 to ERZV20D511

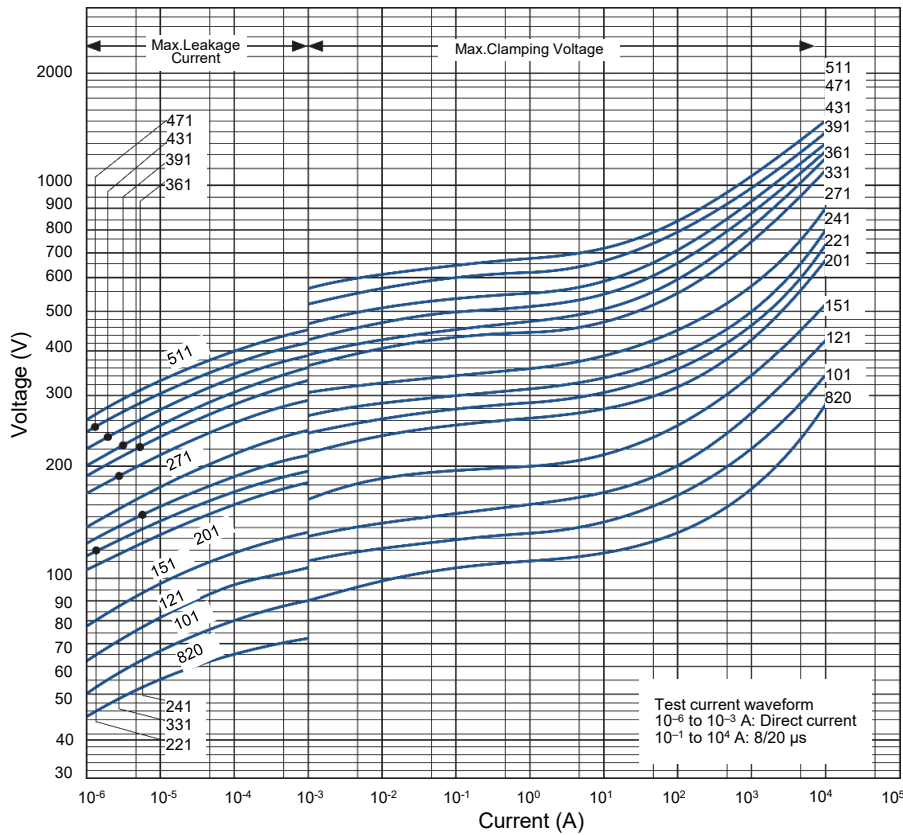

Impulse Derating (Relation between impulse width and impulse current multiple)

ERZV20D820 to ERZV20D511

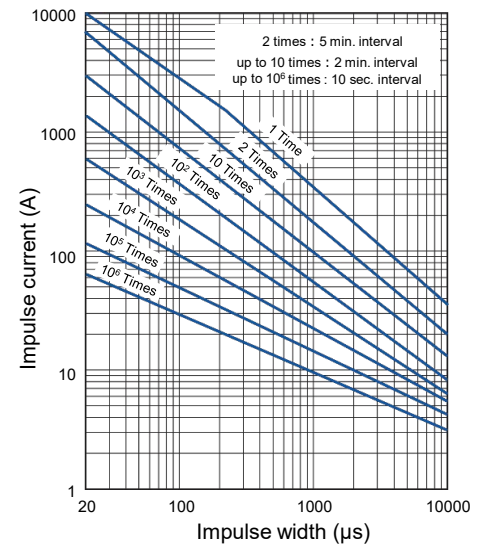

ERZV20D561 to ERZV20D112

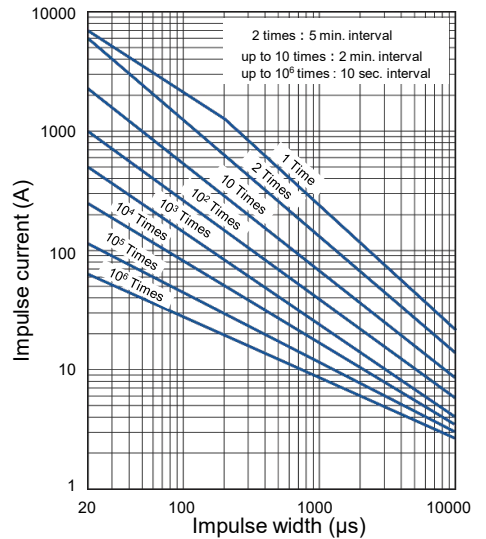

ERZV20D561 to ERZV20D182

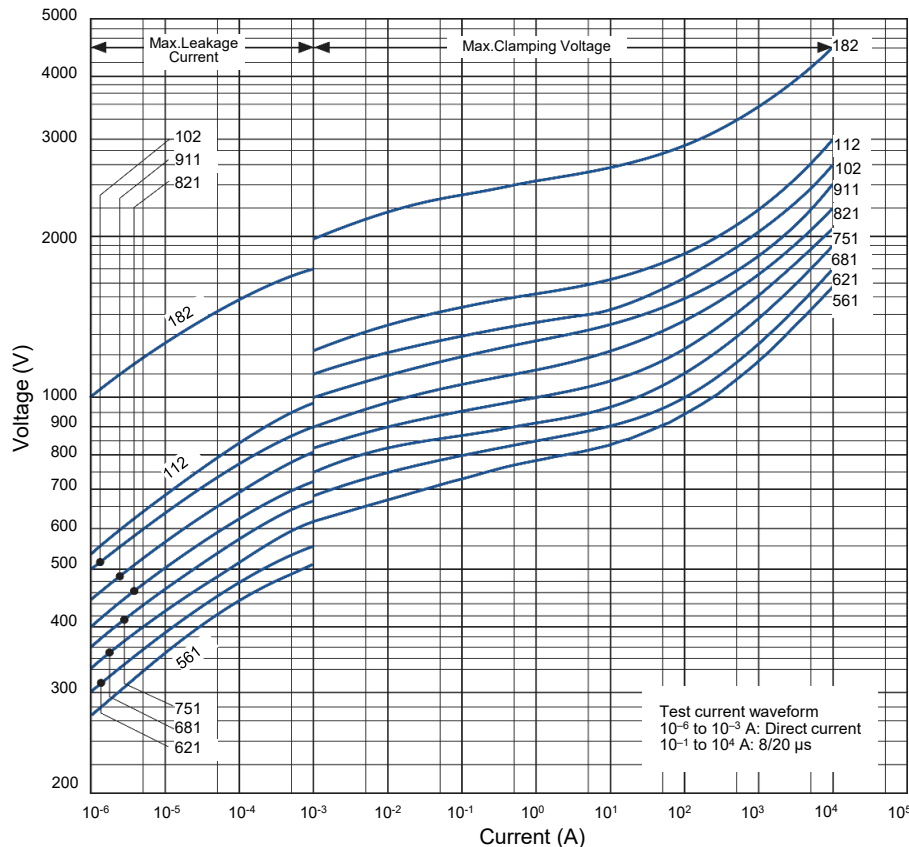

ERZV20D182

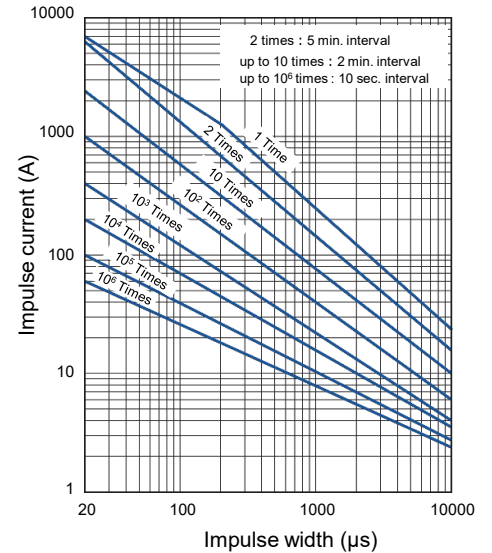



**Straight leads cut type (Bulk type)**

※ Ratings and characteristics is refer to bulk standard type.

**Dimensions in mm (not to scale)**

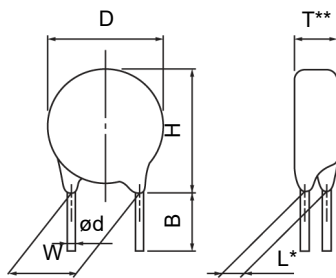

notes \* Dimension "L": Conforms to each individual specification.

\*\* Dimension "T": Conforms to each individual specification.

Unit : mm

Series	5	7	9	10			14		
Varistor voltage Symbol	180 to 471	180 to 511	180 to 511	180 to 511	561 to 751	821 to 112	180 to 511	561 to 751	821 to 112
D	7.0 max.	8.5 max.	11.5max.	11.5max.	12.5max.	12.5max.	15.5 max.	16.0max.	16.0max.
H	10.0 max.	11.5 max.	14.0max.	14.5max.	15.5max.	15.5max.	18.5 max.	19.0max.	19.0max.
W	5.0±1.0	5.0±1.0	5.0±1.0	7.5±1.0	7.5±1.0	7.5±1.0	7.5±1.0	7.5±1.0	7.5±1.0
ø d	0.60 <sup>+0.06</sup> <sub>-0.05</sub>	0.60 <sup>+0.06</sup> <sub>-0.05</sub>	0.60 <sup>+0.06</sup> <sub>-0.05</sub>	0.80 <sup>+0.08</sup> <sub>-0.05</sub>	0.80 <sup>+0.08</sup> <sub>-0.05</sub>	0.80 <sup>+0.08</sup> <sub>-0.05</sub>	0.80 <sup>+0.08</sup> <sub>-0.05</sub>	0.80 <sup>+0.08</sup> <sub>-0.05</sub>	0.80 <sup>+0.08</sup> <sub>-0.05</sub>
B	4.0±1.0	4.0±1.0	4.0±1.0	4.0±1.0	4.0±1.0	4.0±1.5	4.0±1.0	4.0±1.0	4.0±1.5
Standard products part No.	ERZV05D□□□CS	ERZV07D□□□CS	ERZV09D□□□CS	ERZV10D□□□CS	ERZV10D□□□CS	ERZV10D□□□C1	ERZV14D□□□CS	ERZV14D□□□CS	ERZV14D□□□C1

**Crimped leads cut type (Bulk Type)**

※ Ratings and characteristics is refer to bulk standard type.

**Dimensions in mm (not to scale)**

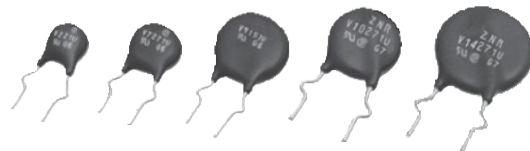
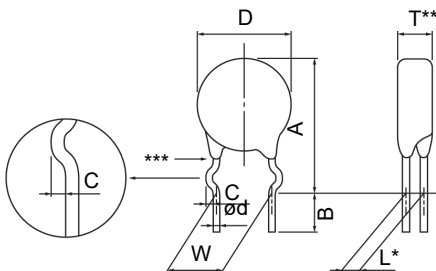

notes \* Dimension "L": Conforms to each individual specification.

\*\* Dimension "T": Conforms to each individual specification.

\*\*\* Resin extenyions : No resin below the center of the hook.

Unit : mm

Series	5	7	9	10			14		
Varistor voltage Symbol	180 to 471	180 to 511	180 to 511	180 to 511	561 to 751	821 to 112	180 to 511	561 to 751	821 to 112
A	13.0 max.	14.5 max.	17.5 max.	17.5 max.	19.0 max.	20.0 max.	21.0 max.	22.0 max.	23.5 max.
D	7.0 max.	8.5 max.	11.5max.	11.5max.	12.5max.	12.5max.	15.5 max.	16.0max.	16.0max.
C	1.2±0.4	1.2±0.4	1.2±0.4	1.4±0.4	1.4±0.4	1.4±0.4	1.4±0.4	1.4±0.4	1.4±0.4
W	5.0±1.0	5.0±1.0	5.0±1.0	7.5±1.0	7.5±1.0	7.5±1.0	7.5±1.0	7.5±1.0	7.5±1.0
ø d	0.60 <sup>+0.06</sup> <sub>-0.05</sub>	0.60 <sup>+0.06</sup> <sub>-0.05</sub>	0.60 <sup>+0.06</sup> <sub>-0.05</sub>	0.80 <sup>+0.08</sup> <sub>-0.05</sub>	0.80 <sup>+0.08</sup> <sub>-0.05</sub>	0.80 <sup>+0.08</sup> <sub>-0.05</sub>	0.80 <sup>+0.08</sup> <sub>-0.05</sub>	0.80 <sup>+0.08</sup> <sub>-0.05</sub>	0.80 <sup>+0.08</sup> <sub>-0.05</sub>
B	4.0±1.0	4.0±1.0	4.0±1.0	4.0±1.0	4.0±1.0	4.0±1.5	4.0±1.0	4.0±1.0	4.0±1.5
Standard products part No.	ERZV05V□□□CS	ERZV07V□□□CS	ERZV09V□□□CS	ERZV10V□□□CS	ERZV10V□□□CS	ERZV10V□□□C1	ERZV14V□□□CS	ERZV14V□□□CS	ERZV14V□□□C1

**Taping specifications for automated assembly (Straight leads and taping)**

※ Ratings and characteristics is refer to bulk standard type.

**Dimensions in mm (not to scale)**

Type I · II

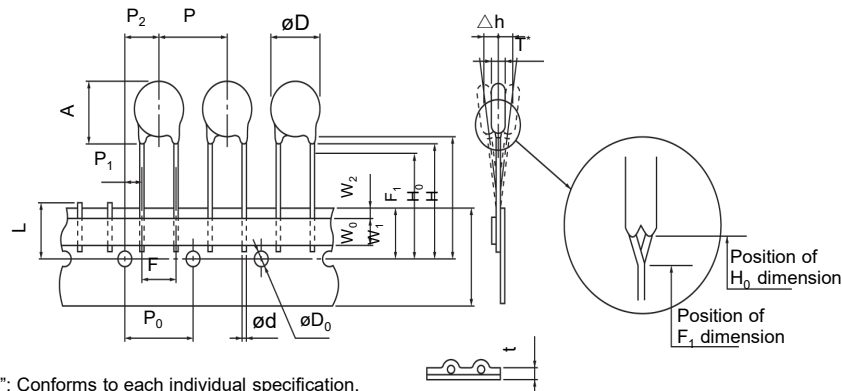

\* Dimension "T": Conforms to each individual specification.

Type III · IV

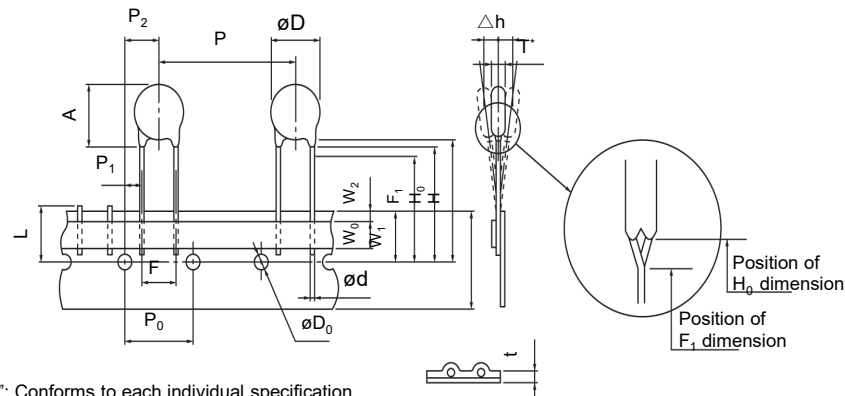

\* Dimension "T": Conforms to each individual specification.

Unit : mm

Series	5	7	9	10			14		
Varistor Voltage	180 to 471	180 to 511	180 to 511	180 to 331	361 to 511	561 to 112	180 to 331	361 to 511	561 to 112
記号 Type	Type I	Type I	Type I	Type I	Type II	Type II	type III	Type IV	Type IV
P	12.7±1.0	12.7±1.0	12.7±1.0	15.0±1.0	15.0±1.0	15.0±1.0	30.0±1.0	30.0±1.0	30.0±1.0
P <sub>0</sub>	12.7±0.3	12.7±0.3	12.7±0.3	15.0±0.3	15.0±0.3	15.0±0.3	15.0±0.3	15.0±0.3	15.0±0.3
P <sub>1</sub>	3.85±0.70	3.85±0.70	3.85±0.70	3.75±0.70	3.75±0.70	3.75±0.70	3.75±0.70	3.75±0.70	3.75±0.70
P <sub>2</sub>	6.35±1.30	6.35±1.30	6.35±1.30	7.5±1.3	7.5±1.3	7.5±1.3	7.5±1.3	7.5±1.3	7.5±1.3
ø d	0.60 <sup>+0.06</sup> <sub>-0.05</sub>	0.60 <sup>+0.06</sup> <sub>-0.05</sub>	0.60 <sup>+0.06</sup> <sub>-0.05</sub>	0.80 <sup>+0.08</sup> <sub>-0.05</sub>	0.80 <sup>+0.08</sup> <sub>-0.05</sub>	0.80 <sup>+0.08</sup> <sub>-0.05</sub>	0.80 <sup>+0.08</sup> <sub>-0.05</sub>	0.80 <sup>+0.08</sup> <sub>-0.05</sub>	0.80 <sup>+0.08</sup> <sub>-0.05</sub>
F	5.0±0.5	5.0±0.5	5.0±0.5	7.5±0.5	7.5±0.5	7.5±0.5	7.5±0.5	7.5±0.5	7.5±0.5
Δ h	0±2	0±2	0±2	0±2	0±2	0±2	0±2	0±2	0±2
W	18.0 <sup>+1.0</sup> <sub>-0.5</sub>	18.0 <sup>+1.0</sup> <sub>-0.5</sub>	18.0 <sup>+1.0</sup> <sub>-0.5</sub>	18.0 <sup>+1.0</sup> <sub>-0.5</sub>	18.0 <sup>+1.0</sup> <sub>-0.5</sub>	18.0 <sup>+1.0</sup> <sub>-0.5</sub>	18.0 <sup>+1.0</sup> <sub>-0.5</sub>	18.0 <sup>+1.0</sup> <sub>-0.5</sub>	18.0 <sup>+1.0</sup> <sub>-0.5</sub>
W <sub>0</sub>	5.0 min.	5.0 min.	5.0 min.	5.0 min.	5.0 min.	5.0 min.	5.0 min.	5.0 min.	5.0 min.
W <sub>1</sub>	9.0±0.5	9.0±0.5	9.0±0.5	9.0±0.5	9.0±0.5	9.0±0.5	9.0±0.5	9.0±0.5	9.0±0.5
W <sub>2</sub>	3 max.	3 max.	3 max.	3 max.	3 max.	3 max.	3 max.	3 max.	3 max.
H	Approx. 20	Approx. 20	Approx. 20	Approx. 22	Approx. 22	Approx. 22	Approx. 22	Approx. 22	Approx. 22
H <sub>0</sub>	17.0±0.5	17.0±0.5	17.0±0.5	18.0 <sup>+2.0</sup> <sub>0</sub>	---	---	18.0 <sup>+2.0</sup> <sub>0</sub>	---	---
F <sub>1</sub>	---	---	---	---	16.00 <sup>+0.75</sup> <sub>-0.5</sub>	16.00 <sup>+0.75</sup> <sub>-0.5</sub>	---	16.00 <sup>+0.75</sup> <sub>-0.5</sub>	16.00 <sup>+0.75</sup> <sub>-0.5</sub>
øD <sub>0</sub>	ø4.0±0.2	ø4.0±0.2	ø4.0±0.2	ø4.0±0.2	ø4.0±0.2	ø4.0±0.2	ø4.0±0.2	ø4.0±0.2	ø4.0±0.2
t	0.6±0.3	0.6±0.3	0.6±0.3	0.6±0.3	0.6±0.3	0.6±0.3	0.6±0.3	0.6±0.3	0.6±0.3
L	11 max.	11 max.	11 max.	11 max.	11 max.	11 max.	11 max.	11 max.	11 max.
øD	7.0 max.	8.5 max.	11.5 max.	11.5 max.	11.5 max.	12.5 max.	15.5 max.	15.5 max.	16.0 max.
A	10.0 max.	11.5 max.	14.0 max.	14.5 max.	14.5 max.	15.5 max.	18.5 max.	18.5 max.	19.0 max.
Standard Products Part No.	ERZVA5D□□□	ERZVA7D□□□	ERZVA9D□□□	ERZVGAD□□□	ERZVGAD□□□	ERZVGAD□□□	ERZVGED□□□	ERZVGED□□□	ERZVGED□□□



## D type / V series (Taping specifications)

### Taping specifications for automated assembly (Crimped leads and taping)

※ Ratings and characteristics is refer to bulk standard type.

### Dimensions in mm (not to scale)

Type I

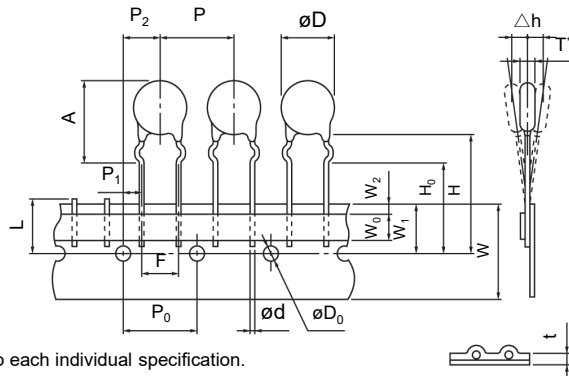

\* Dimension "T": Conforms to each individual specification.

Type II

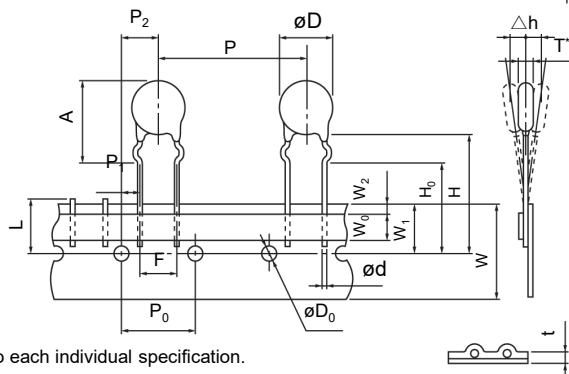

\* Dimension "T": Conforms to each individual specification.

Unit : mm

Series	5	7	9	10			14		
Varistor Voltage	180 to 471	180 to 511	180 to 511	180 to 331	361 to 511	561 to 112	180 to 331	361 to 511	561 to 112
Type	Type I	Type I	Type I	Type I	Type I	Type I	Type II	Type II	Type II
P	12.7±1.0	12.7±1.0	12.7±1.0	15.0±1.0	15.0±1.0	15.0±1.0	30.0±1.0	30.0±1.0	30.0±1.0
P <sub>0</sub>	12.7±0.3	12.7±0.3	12.7±0.3	15.0±0.3	15.0±0.3	15.0±0.3	15.0±0.3	15.0±0.3	15.0±0.3
P <sub>1</sub>	3.85±0.70	3.85±0.70	3.85±0.70	3.75±0.70	3.75±0.70	3.75±0.70	3.75±0.70	3.75±0.70	3.75±0.70
P <sub>2</sub>	6.35±1.30	6.35±1.30	6.35±1.30	7.5±1.3	7.5±1.3	7.5±1.3	7.5±1.3	7.5±1.3	7.5±1.3
ø d	0.60 <sup>+0.06</sup> <sub>-0.05</sub>	0.60 <sup>+0.06</sup> <sub>-0.05</sub>	0.60 <sup>+0.06</sup> <sub>-0.05</sub>	0.80 <sup>+0.08</sup> <sub>-0.05</sub>	0.80 <sup>+0.08</sup> <sub>-0.05</sub>	0.80 <sup>+0.08</sup> <sub>-0.05</sub>	0.80 <sup>+0.08</sup> <sub>-0.05</sub>	0.80 <sup>+0.08</sup> <sub>-0.05</sub>	0.80 <sup>+0.08</sup> <sub>-0.05</sub>
F	5.0±0.5	5.0±0.5	5.0±0.5	7.5±0.5	7.5±0.5	7.5±0.5	7.5±0.5	7.5±0.5	7.5±0.5
Δ h	0±2	0±2	0±2	0±2	0±2	0±2	0±2	0±2	0±2
W	18.0 <sup>+1.0</sup> <sub>-0.5</sub>	18.0 <sup>+1.0</sup> <sub>-0.5</sub>	18.0 <sup>+1.0</sup> <sub>-0.5</sub>	18.0 <sup>+1.0</sup> <sub>-0.5</sub>	18.0 <sup>+1.0</sup> <sub>-0.5</sub>	18.0 <sup>+1.0</sup> <sub>-0.5</sub>	18.0 <sup>+1.0</sup> <sub>-0.5</sub>	18.0 <sup>+1.0</sup> <sub>-0.5</sub>	18.0 <sup>+1.0</sup> <sub>-0.5</sub>
W <sub>0</sub>	5.0 min.	5.0 min.	5.0 min.	5.0 min.	5.0 min.	5.0 min.	5.0 min.	5.0 min.	5.0 min.
W <sub>1</sub>	9.0±0.5	9.0±0.5	9.0±0.5	9.0±0.5	9.0±0.5	9.0±0.5	9.0±0.5	9.0±0.5	9.0±0.5
W <sub>2</sub>	3 max.	3 max.	3 max.	3 max.	3 max.	3 max.	3 max.	3 max.	3 max.
H	Approx. 22	Approx. 22	Approx. 22	Approx. 22	Approx. 22	Approx. 22	Approx. 22	Approx. 22	Approx. 22
H <sub>0</sub>	17.0±0.5	17.0±0.5	17.0±0.5	16.0±0.5	16.0±0.5	16.0±0.5	16.0±0.5	16.0±0.5	16.0±0.5
øD <sub>0</sub>	ø4.0±0.2	ø4.0±0.2	ø4.0±0.2	ø4.0±0.2	ø4.0±0.2	ø4.0±0.2	ø4.0±0.2	ø4.0±0.2	ø4.0±0.2
t	0.6±0.3	0.6±0.3	0.6±0.3	0.6±0.3	0.6±0.3	0.6±0.3	0.6±0.3	0.6±0.3	0.6±0.3
L	11 max.	11 max.	11 max.	11 max.	11 max.	11 max.	11 max.	11 max.	11 max.
øD	7.0 max.	8.5 max.	11.5 max.	11.5 max.	11.5 max.	12.5 max.	15.5 max.	15.5 max.	16.0 max.
A	13.0 max.	14.5 max.	17.5 max.	17.5 max.	17.5 max.	*(refer)	21.0 max.	21.0 max.	*(refer)
Standard Products Part No.	ERZVA5V□□□	ERZVA7V□□□	ERZVA9V□□□	ERZVEAV□□□	ERZVEAV□□□	ERZVEAV□□□	ERZVEEV□□□	ERZVEEV□□□	ERZVEEV□□□

**\*Dimension "A"**

Part No.	10 Series	14 Series
ERZV□□V561	19.0 max.	22.0 max.
ERZV□□V621	19.0 max.	22.0 max.
ERZV□□V681	19.0 max.	22.0 max.
ERZV□□V751	19.0 max.	22.0 max.

Part No.	10 Series	14 Series
ERZV□□V821	20.0 max.	23.5 max.
ERZV□□V911	20.0 max.	23.5 max.
ERZV□□V102	20.0 max.	23.5 max.
ERZV□□V112	20.0 max.	23.5 max.

## Application note for safety standards

- Approvals products lists in "Reference Guide to Standard Products."
- UL and VDE : Registered in "Type name", it isn't registered in "Panasonic Part No."
- CQC : Registered in "Panasonic Part No."
- "Rated Voltages" are specified for UL recognized components in list shown below.

## The AC rated voltage and maximum allowable voltage

Type name	Maximum allowable voltage		Rated voltage (Vrms)	
	ACrms (V)	DC (V)	UL1449	CSA C22.2 No.269.5
V*820U	50	65	45	N/A
V*101U	60	85	55	N/A
V*121U	75	100	68	N/A
V*151U	95	125	86	N/A
V*201U	130	170	118	118
V*221U	140	180	127	127
V*241U	150	200	136	136
V*271U	175	225	159	159
V*331U	210	270	189	189
V*361U	230	300	209	209
V*391U	250	320	227	227
V*431U	275	350	250	250
V*471U	300	385	272	272
V*511U	320	410	291	291
V*561U	350	450	320	320
V*621U	385	505	350	350
V*681U	420	560	381	381
V*751U	460	615	418	418
V*821U	510	670	463	463
V*911U	550	745	500	500
V*102U	625	825	568	568
V*112U	680	895	600	618
V*182U	1000	1465	600	909

\* : 5 Series is blank, 7 series is 7, 9 series is 9, 10 series is 10, 14 series is 14, 20 series is 20

**Explanation of the contents**

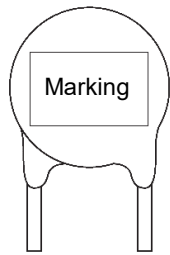

Mark	Explanation of the content	
V*□□□	Abbreviation of Part No. (Type name)	[ □□□ Nominal varistor volage ]
V*□□□U		
○	Factory identification mark	None : Japan Q : Indonesia
◆*1	Year code	2019 : 9, 2020 : K, 2021 : A 2022 : B, 2023 : C, 2024 : D
◇	Monthly code	Jan : 1 to Sep : 9, Oct. : 0, Nov. : N, Dec. : D
	UL recognized components mark	
	CSA monogram	

\* : 5 series is blank, 7 series is 7, 9 series is 9, 10 series is 10, 14 series is 14, 20 series is 20

\*1: If the 10's digit of a Christian year is an even year, as an end abbreviation, an alphabetic character is used.

1 : A, 2 : B, 3 : C, 4 : D, 5 : E, 6 : F, 7 : G, 8 : H, 9 : J, 0 : K

If the 10's digit of a Christian year is an odd year, as an end abbreviation, a number is used.

**Marking contents**

Series (Example) Varistor voltage	5 (ERZV05D□□□)	7 (ERZV07D□□□)	9 (ERZV09D□□□)	10 (ERZV10D□□□)	14 (ERZV14D□□□)	20 (ERZV20D□□□)
180 to 680	V□□□ ○◆◆	V7□□□ ○◆◆	V9□□□ ○◆◆	ZNR V10□□□ ○◆◆	ZNR V14□□□ ○◆◆	ZNR V20□□□ ○◆◆
820 to 151	V□□□U ○◆◆	V7□□□U ○◆◆	V9□□□U ○◆◆	ZNR V10□□□U ○◆◆	ZNR V14□□□U ○◆◆	ZNR V20□□□U ○◆◆
201 or more	 V□□□U ○◆◆	 V7□□□U ○◆◆	 V9□□□U ○◆◆	ZNR V10□□□U ○◆◆	ZNR V14□□□U ○◆◆	ZNR V20□□□U ○◆◆

**Performance characteristics**

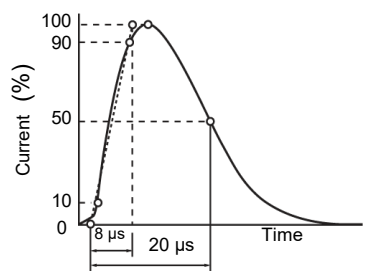
Characteristics		Test methods / description	Specifications																																																																																		
Standard test condition		Electrical measurements (initial/after tests) shall be conducted at temperature of 5 to 35 °C, relative humidity of maximum 85 %.	—																																																																																		
Electrical	Varistor voltage	The voltage between two terminals with the specified measuring current $C_{mA}$ DC applied is called VC or $V_{CmA}$ . The measurement shall be made as fast as possible to avoid heat affection.	To meet the specified value.																																																																																		
	Maximum allowable voltage	The maximum sinusoidal RMS voltage or maximum DC voltage that can be applied continuously.																																																																																			
	Clamping voltage	The maximum voltage between two terminals with the specified standard impulse current (8/20 $\mu$ s) illustrated below applied. 																																																																																			
	Rated power	The power that can be applied in the specified ambient temperature.																																																																																			
	Maximum energy	The maximum energy within the varistor voltage change of $\pm 10$ % when a single impulse current of 2 ms or 10/1000 $\mu$ s is applied.																																																																																			
	Maximum peak current (Withstanding Surge Current)	2 times		The maximum current within the varistor voltage change of $\pm 10$ % when a standard impulse current of 8/20 $\mu$ s is applied two times with an interval of 5 minutes.																																																																																	
		1 time		The maximum current within the varistor voltage change of $\pm 10$ % with a single standard impulse current of 8/20 $\mu$ s is applied.																																																																																	
	Temperature coefficient of varistor voltage	$\frac{V_{CmA} \text{ at } 85 \text{ }^\circ\text{C} - V_{CmA} \text{ at } 25 \text{ }^\circ\text{C}}{V_{CmA} \text{ at } 25 \text{ }^\circ\text{C}} \times \frac{1}{60} 100(\%/^\circ\text{C})$		0 to -0.05 %/ °C max.																																																																																	
	Capacitance	Capacitance shall be measured at 1 kHz $\pm 10$ %, 1 Vrms max. (1 MHz $\pm 10$ % below 100 pF), 0 V bias and 20 $\pm 2$ °C.		To meet the specified value.																																																																																	
	Withstanding voltage (Body Insulation)	The specified voltage shall be applied between both terminals of the specimen connected together and metal foil closely wrapped round its body for 1 minute. <table border="1" data-bbox="406 1332 1197 1444"> <thead> <tr> <th>Classification (Nominal varistor voltage)</th> <th>Test Voltage (AC)</th> </tr> </thead> <tbody> <tr> <td><math>V_{0.1 mA}, V_{1 mA} \leq 330 \text{ V}</math></td> <td>1000 Vrms</td> </tr> <tr> <td><math>V_{0.1 mA}, V_{1 mA} &gt; 330 \text{ V}</math></td> <td>1500 Vrms</td> </tr> </tbody> </table>		Classification (Nominal varistor voltage)	Test Voltage (AC)	$V_{0.1 mA}, V_{1 mA} \leq 330 \text{ V}$	1000 Vrms	$V_{0.1 mA}, V_{1 mA} > 330 \text{ V}$	1500 Vrms	No breakdown																																																																											
Classification (Nominal varistor voltage)	Test Voltage (AC)																																																																																				
$V_{0.1 mA}, V_{1 mA} \leq 330 \text{ V}$	1000 Vrms																																																																																				
$V_{0.1 mA}, V_{1 mA} > 330 \text{ V}$	1500 Vrms																																																																																				
Impulse life	The change of VC shall be measured after the impulse current listed below is applied 10000 or 100000 times continuously with the interval of 10 seconds at room temperature. <table border="1" data-bbox="438 1545 1197 2105"> <thead> <tr> <th rowspan="2">Part No.</th> <th rowspan="2">Current</th> <th>Item</th> <th>Impulse Life( I )</th> <th>Impulse Life( II )</th> </tr> <tr> <th>Times</th> <th><math>\times 10^4</math> Times</th> <th><math>\times 10^5</math> Times</th> </tr> </thead> <tbody> <tr> <td>ERZV05D180 to ERZV05D680</td> <td>8 A (8/20 <math>\mu</math>s)</td> <td></td> <td>5 A (8/20 <math>\mu</math>s)</td> <td></td> </tr> <tr> <td>ERZV07D180 to ERZV07D680</td> <td>25 A (8/20 <math>\mu</math>s)</td> <td></td> <td>15 A (8/20 <math>\mu</math>s)</td> <td></td> </tr> <tr> <td>ERZV09D180 to ERZV09D680</td> <td>50 A (8/20 <math>\mu</math>s)</td> <td></td> <td>35 A (8/20 <math>\mu</math>s)</td> <td></td> </tr> <tr> <td>ERZV10D180 to ERZV10D680</td> <td>50 A (8/20 <math>\mu</math>s)</td> <td></td> <td>35 A (8/20 <math>\mu</math>s)</td> <td></td> </tr> <tr> <td>ERZV14D180 to ERZV14D680</td> <td>90 A (8/20 <math>\mu</math>s)</td> <td></td> <td>50 A (8/20 <math>\mu</math>s)</td> <td></td> </tr> <tr> <td>ERZV20D180 to ERZV20D680</td> <td>130 A (8/20 <math>\mu</math>s)</td> <td></td> <td>65 A (8/20 <math>\mu</math>s)</td> <td></td> </tr> <tr> <td>ERZV05D820 to ERZV05D471</td> <td>40 A (8/20 <math>\mu</math>s)</td> <td></td> <td>25 A (8/20 <math>\mu</math>s)</td> <td></td> </tr> <tr> <td>ERZV07D820 to ERZV07D511</td> <td>100 A (8/20 <math>\mu</math>s)</td> <td></td> <td>60 A (8/20 <math>\mu</math>s)</td> <td></td> </tr> <tr> <td>ERZV09D820 to ERZV09D511</td> <td>150 A (8/20 <math>\mu</math>s)</td> <td></td> <td>85 A (8/20 <math>\mu</math>s)</td> <td></td> </tr> <tr> <td>ERZV10D820 to ERZV10D112</td> <td>150 A (8/20 <math>\mu</math>s)</td> <td></td> <td>85 A (8/20 <math>\mu</math>s)</td> <td></td> </tr> <tr> <td>ERZV10D182CS</td> <td>120 A (8/20 <math>\mu</math>s)</td> <td></td> <td>75 A (8/20 <math>\mu</math>s)</td> <td></td> </tr> <tr> <td>ERZV14D820 to ERZV14D112</td> <td>200 A (8/20 <math>\mu</math>s)</td> <td></td> <td>110 A (8/20 <math>\mu</math>s)</td> <td></td> </tr> <tr> <td>ERZV14D182CS</td> <td>150 A (8/20 <math>\mu</math>s)</td> <td></td> <td>90 A (8/20 <math>\mu</math>s)</td> <td></td> </tr> <tr> <td>ERZV20D820 to ERZV20D112</td> <td>250 A (8/20 <math>\mu</math>s)</td> <td></td> <td>120 A (8/20 <math>\mu</math>s)</td> <td></td> </tr> <tr> <td>ERZV20D182</td> <td>200 A (8/20 <math>\mu</math>s)</td> <td></td> <td>100 A (8/20 <math>\mu</math>s)</td> <td></td> </tr> </tbody> </table>	Part No.	Current	Item	Impulse Life( I )	Impulse Life( II )	Times	$\times 10^4$ Times	$\times 10^5$ Times	ERZV05D180 to ERZV05D680	8 A (8/20 $\mu$ s)		5 A (8/20 $\mu$ s)		ERZV07D180 to ERZV07D680	25 A (8/20 $\mu$ s)		15 A (8/20 $\mu$ s)		ERZV09D180 to ERZV09D680	50 A (8/20 $\mu$ s)		35 A (8/20 $\mu$ s)		ERZV10D180 to ERZV10D680	50 A (8/20 $\mu$ s)		35 A (8/20 $\mu$ s)		ERZV14D180 to ERZV14D680	90 A (8/20 $\mu$ s)		50 A (8/20 $\mu$ s)		ERZV20D180 to ERZV20D680	130 A (8/20 $\mu$ s)		65 A (8/20 $\mu$ s)		ERZV05D820 to ERZV05D471	40 A (8/20 $\mu$ s)		25 A (8/20 $\mu$ s)		ERZV07D820 to ERZV07D511	100 A (8/20 $\mu$ s)		60 A (8/20 $\mu$ s)		ERZV09D820 to ERZV09D511	150 A (8/20 $\mu$ s)		85 A (8/20 $\mu$ s)		ERZV10D820 to ERZV10D112	150 A (8/20 $\mu$ s)		85 A (8/20 $\mu$ s)		ERZV10D182CS	120 A (8/20 $\mu$ s)		75 A (8/20 $\mu$ s)		ERZV14D820 to ERZV14D112	200 A (8/20 $\mu$ s)		110 A (8/20 $\mu$ s)		ERZV14D182CS	150 A (8/20 $\mu$ s)		90 A (8/20 $\mu$ s)		ERZV20D820 to ERZV20D112	250 A (8/20 $\mu$ s)		120 A (8/20 $\mu$ s)		ERZV20D182	200 A (8/20 $\mu$ s)		100 A (8/20 $\mu$ s)		$\Delta V_{CmA}/V_{CmA} \leq \pm 10$ %
Part No.	Current			Item	Impulse Life( I )	Impulse Life( II )																																																																															
		Times	$\times 10^4$ Times	$\times 10^5$ Times																																																																																	
ERZV05D180 to ERZV05D680	8 A (8/20 $\mu$ s)		5 A (8/20 $\mu$ s)																																																																																		
ERZV07D180 to ERZV07D680	25 A (8/20 $\mu$ s)		15 A (8/20 $\mu$ s)																																																																																		
ERZV09D180 to ERZV09D680	50 A (8/20 $\mu$ s)		35 A (8/20 $\mu$ s)																																																																																		
ERZV10D180 to ERZV10D680	50 A (8/20 $\mu$ s)		35 A (8/20 $\mu$ s)																																																																																		
ERZV14D180 to ERZV14D680	90 A (8/20 $\mu$ s)		50 A (8/20 $\mu$ s)																																																																																		
ERZV20D180 to ERZV20D680	130 A (8/20 $\mu$ s)		65 A (8/20 $\mu$ s)																																																																																		
ERZV05D820 to ERZV05D471	40 A (8/20 $\mu$ s)		25 A (8/20 $\mu$ s)																																																																																		
ERZV07D820 to ERZV07D511	100 A (8/20 $\mu$ s)		60 A (8/20 $\mu$ s)																																																																																		
ERZV09D820 to ERZV09D511	150 A (8/20 $\mu$ s)		85 A (8/20 $\mu$ s)																																																																																		
ERZV10D820 to ERZV10D112	150 A (8/20 $\mu$ s)		85 A (8/20 $\mu$ s)																																																																																		
ERZV10D182CS	120 A (8/20 $\mu$ s)		75 A (8/20 $\mu$ s)																																																																																		
ERZV14D820 to ERZV14D112	200 A (8/20 $\mu$ s)		110 A (8/20 $\mu$ s)																																																																																		
ERZV14D182CS	150 A (8/20 $\mu$ s)		90 A (8/20 $\mu$ s)																																																																																		
ERZV20D820 to ERZV20D112	250 A (8/20 $\mu$ s)		120 A (8/20 $\mu$ s)																																																																																		
ERZV20D182	200 A (8/20 $\mu$ s)		100 A (8/20 $\mu$ s)																																																																																		

## Performance characteristics

Characteristics	Test methods / description	Specifications																
Mechanical	<p>Robustness of terminations (Tensile)</p> <p>After gradually applying the force specified below and keeping the unit fixed for 10 seconds, the terminal shall be visually examined for any damage.</p> <table border="1"> <thead> <tr> <th>Terminal diameter</th> <th>Force</th> </tr> </thead> <tbody> <tr> <td>ø0.6 mm, ø0.8 mm</td> <td>9.8 N</td> </tr> <tr> <td>ø1.0 mm</td> <td>19.6 N</td> </tr> </tbody> </table>	Terminal diameter	Force	ø0.6 mm, ø0.8 mm	9.8 N	ø1.0 mm	19.6 N	No remarkable mechanical damage										
	Terminal diameter	Force																
	ø0.6 mm, ø0.8 mm	9.8 N																
	ø1.0 mm	19.6 N																
	<p>Robustness of terminations (Bending)</p> <p>The unit shall be secured with its terminal kept vertical and the force specified below shall be applied in the axial direction. The terminal shall gradually be bent by 90 ° in one direction, then 90 ° in the opposite direction, and again back to the original position. The damage of the terminal shall be visually examined.</p> <table border="1"> <thead> <tr> <th>Terminal diameter</th> <th>Force</th> </tr> </thead> <tbody> <tr> <td>ø0.6 mm, ø0.8 mm</td> <td>4.9 N</td> </tr> <tr> <td>ø1.0 mm</td> <td>9.8 N</td> </tr> </tbody> </table>	Terminal diameter	Force	ø0.6 mm, ø0.8 mm	4.9 N	ø1.0 mm	9.8 N											
Terminal diameter	Force																	
ø0.6 mm, ø0.8 mm	4.9 N																	
ø1.0 mm	9.8 N																	
Vibration	After repeatedly applying a single harmonic vibration (amplitude: 0.75 mm, double amplitude: 1.5 mm) with 1 minute vibration frequency cycles (10 Hz to 55 Hz to 10 Hz) to each of three perpendicular directions for 2 hours. Thereafter, the unit shall be visually examined.																	
Solderability	After dipping the terminals to a depth of approximately 3 mm from the body in a soldering bath of 235±5 °C for 2±0.5 seconds, the terminal shall be visually examined.	Approximately 95 % of the terminals shall be covered with new solder uniformly.																
Resistance to soldering heat	After each lead shall be dipped into a solder bath having a temperature of 260±5 °C to a point 2.0 to 2.5 mm from the body of the unit, using shielding board (t=1.5 mm), be held there for 10±1 s and then be stored at room temperature and normal humidity for 1 to 2 hours. The change of $V_{CmA}$ and mechanical damages shall be examined.	$\Delta V_{CmA}/V_{CmA} \leq \pm 5 \%$																
Environmental	High temperature storage/Dry heat	The specimen shall be subjected to 125±2 °C for 1000 hours in a thermostatic bath without load and then stored at room temperature and normal humidity for 1 to 2 hours. Thereafter, the change of $V_{CmA}$ shall be measured.	$\Delta V_{CmA}/V_{CmA} \leq \pm 5 \%$															
	Humidity	The specimen shall be subjected to 40±2 °C, 90 to 95 % RH for 1000 hours without load and then stored at room temperature and normal humidity for 1 to 2 hours. Thereafter, the change of $V_{CmA}$ shall be measured.																
	Temperature cycle	<p>The temperature cycle shown below shall be repeated five cycles and then stored at room temperature and normal humidity for 1 to 2 hours. The change of <math>V_{CmA}</math> and mechanical damage shall be examined.</p> <table border="1"> <thead> <tr> <th>Step</th> <th>Temperature (°C)</th> <th>Period (minutes)</th> </tr> </thead> <tbody> <tr> <td>1</td> <td>-40±3</td> <td>30±3</td> </tr> <tr> <td>2</td> <td>Room temperature</td> <td>15±3</td> </tr> <tr> <td>3</td> <td>125±2</td> <td>30±3</td> </tr> <tr> <td>4</td> <td>Room temperature</td> <td>15±3</td> </tr> </tbody> </table>	Step	Temperature (°C)	Period (minutes)	1	-40±3	30±3	2	Room temperature	15±3	3	125±2	30±3	4	Room temperature	15±3	$\Delta V_{CmA}/V_{CmA} \leq \pm 5 \%$ No remarkable mechanical damage
	Step	Temperature (°C)	Period (minutes)															
	1	-40±3	30±3															
2	Room temperature	15±3																
3	125±2	30±3																
4	Room temperature	15±3																
High temperature load/Dry heat load	After being continuously applied the Maximum Allowable Voltage at 85±2 °C for 1000 hours, the specimen shall be stored at room temperature and normal humidity for 1 to 2 hours. Thereafter, the change of $V_{CmA}$ shall be measured.	$\Delta V_{CmA}/V_{CmA} \leq \pm 10 \%$																
Damp heat load/Humidity load	The specimen shall be subjected to 40±2 °C, 90 to 95 % RH and the Maximum Allowable Voltage for 1000 hours and then stored at room temperature and normal humidity for 1 to 2 hours. Thereafter, the change of $V_{CmA}$ shall be measured.																	
Low temperature storage/Cold	The specimen shall be subjected to -40±2 °C without load for 1000 hours and then stored at room temperature and normal humidity for 1 to 2 hours. Thereafter, the change of $V_{CmA}$ shall be measured.	$\Delta V_{CmA}/V_{CmA} \leq \pm 5 \%$																

## Minimum quantity / Packing unit

Product	Series / Type		Part number	Minimum quantity / Packing unit	Packing quantity in carton	Carton (about) L×W×H (mm)
"ZNR" Transient/ surge absorbers	D type V series	Straight leads <Bulk>	ERZV05D180 to 271	100	10000	210×340×160
			ERZV05D331 to 471	100	10000	210×340×180
			ERZV07D180 to 470	100	10000	210×340×160
			ERZV07D560 to 680	100	10000	210×340×180
			ERZV07D820 to 121	100	10000	210×340×160
			ERZV07D151 to 271	100	10000	210×340×180
			ERZV07D331 to 511	100	5000	210×340×110
			ERZV09D180 to 121	100	5000	210×340×160
			ERZV09D151 to 271	100	4000	210×340×130
			ERZV09D331 to 511	100	4000	210×340×160
			ERZV10D180 to 121	50	5000	210×340×160
			ERZV10D151 to 271	50	4000	210×340×130
			ERZV10D331 to 621	50	4000	210×340×160
			ERZV10D681 to 821	50	2000	210×340×80
			ERZV10D911 to 112	50	2000	210×340×110
			ERZV10D182CS	50	1000	210×340×80
			ERZV14D180 to 121	50	3000	210×340×110
			ERZV14D151 to 271	50	3000	210×340×130
			ERZV14D331 to 621	50	2000	210×340×110
			ERZV14D681 to 821	50	2000	210×340×110
			ERZV14D911 to 112	50	1000	210×340×80
			ERZV14D182CS	50	1000	210×340×80
			ERZV20D180 to 271	50	2000	210×340×160
			ERZV20D331 to 511	50	1000	210×340×80
			ERZV20D561 to 821	50	1000	210×340×110
			ERZV20D911 to 112	50	1000	210×340×110
			ERZV20D182	25	500	210×340×80
			ERZV05D(V)180CS to 271CS	100	10000	210×340×80
	ERZV05D(V)331CS to 471CS	100	10000	210×340×110		
	ERZV07D(V)180CS to 271CS	100	10000	210×340×80		
	ERZV07D(V)331CS to 511CS	100	10000	210×340×110		
	ERZV09D(V)180CS to 121CS	100	5000	210×340×110		
	ERZV09D(V)151CS to 511CS	100	4000	210×340×80		
	ERZV10D(V)180CS to 121CS	100	5000	210×340×110		
	ERZV10D(V)151CS to 621CS	100	4000	210×340×80		
	ERZV10D(V)681CS to 751CS	100	2000	210×340×80		
	ERZV10D(V)821C1 to 112C1	100	2000	210×340×80		
	ERZV14D(V)180CS to 271CS	100	3000	210×340×80		
	ERZV14D(V)331CS to 821C1	100	2000	210×340×80		
	ERZV14D(V)911C1 to 112C1	100	1000	210×340×80		
	D type V series	Straight leads and taped	ERZVA5D180 to 271	1000	10000	360×320×260
			ERZVA5D331 to 471	1000	10000	400×360×260
			ERZVA7D180 to 271	1000	10000	400×360×260
			ERZVA7D331 to 511	1000	10000	470×360×260
			ERZVA9D180 to 271	1000	10000	400×360×260
			ERZVA9D331 to 511	1000	10000	470×360×260
ERZVGAD180 to 621			1000	5000	360×310×320	
ERZVGAD681 to 112			500	2500	360×270×320	
ERZVGED180 to 511			500	2500	360×310×320	
ERZVGED561 to 112			250	1250	360×270×320	
Crimped lead and taped		ERZVA5V180 to 271	1000	10000	360×320×260	
		ERZVA5V331 to 471	1000	10000	400×360×260	
		ERZVA7V180 to 271	1000	10000	400×360×260	
		ERZVA7V331 to 511	1000	10000	470×360×260	
		ERZVA9V180 to 271	1000	10000	400×360×300	
		ERZVA9V331 to 511	1000	10000	470×360×300	
		ERZVEAV180 to 621	1000	5000	360×310×320	
		ERZVEAV681 to 112	500	2500	360×270×320	
		ERZVEEV180 to 511	500	2500	360×310×320	
		ERZVEEV561 to 112	250	1250	360×270×320	

Part No., quantity and country of origin are designated on outer packages in English.

※ Please contact local sales office about packing specifications.

## Safety and Legal Matters to Be Observed

### Product specifications and applications

- Please be advised that this product and product specifications are subject to change without notice for improvement purposes. Therefore, please request and confirm the latest delivery specifications that explain the specifications in detail before the final design, or purchase or use of the product, regardless of the application. In addition, do not use this product in any way that deviates from the contents of the company's delivery specifications.
- Unless otherwise specified in this catalog or the product specifications, this product is intended for use in general electronic equipment (AV products, home appliances, commercial equipment, office equipment, information and communication equipment, etc.).  
When this product is used for the following special cases, the specification document suited to each application shall be signed/sealed (with Panasonic and the user) in advance..These include applications requiring special quality and reliability, wherein their failures or malfunctions may directly threaten human life or cause harm to the human body (e.g.: space/aircraft equipment, transportation/traffic equipment, combustion equipment, medical equipment, disaster prevention/crime prevention equipment, safety equipment, etc.).

### Safety design and product evaluation

- Please ensure safety through protection circuits, redundant circuits, etc., in the customer's system design so that a defect in our company's product will not endanger human life or cause other serious damage.
- This catalog shows the quality and performance of individual parts. The durability of parts varies depending on the usage environment and conditions. Therefore, please ensure to evaluate and confirm the state of each part after it has been mounted in your product in the actual operating environment before use.  
If you have any doubts about the safety of this product, then please notify us immediately, and be sure to conduct a technical review including the above protection circuits and redundant circuits at your company.

### Laws / Regulations / Intellectual property

- The transportation of dangerous goods as designated by UN numbers, UN classifications, etc., does not apply to this product. In addition, when exporting products, product specifications, and technical information described in this catalog, please comply with the laws and regulations of the countries to which the products are exported, especially those concerning security export control.
- Each model of this product complies with the RoHS Directive (Restriction of the use of hazardous substances in electrical and electronic equipment) (2011/65/EU and (EU) 2015/863). The date of compliance with the RoHS Directive and REACH Regulation varies depending on the product model.  
Further, if you are using product models in stock and are not sure whether or not they comply with the RoHS Directive or REACH Regulation, please contact us by selecting "Sales Inquiry" from the inquiry form.
- During the manufacturing process of this product and any of its components and materials to be used, Panasonic does not intentionally use ozone-depleting substances stipulated in the Montreal Protocol and specific bromine-based flame retardants such as PBBs (Poly-Brominated Biphenyls) / PBDEs (Poly-Brominated Diphenyl Ethers). In addition, the materials used in this product are all listed as existing chemical substances based on the Act on the Regulation of Manufacture and Evaluation of Chemical Substances.
- With regard to the disposal of this product, please confirm the disposal method in each country and region where it is incorporated into your company's product and used.
- The technical information contained in this catalog is intended to show only typical operation and application circuit examples of this product. This catalog does not guarantee that such information does not infringe upon the intellectual property rights of Panasonic or any third party, nor imply that the license of such rights has been granted.

**Panasonic Industry will assume no liability whatsoever if the use of our company's products deviates from the contents of this catalog or does not comply with the precautions. Please be advised of these restrictions.**



## Matters to Be Observed When Using This Product

(D-type : V series / SMD-type : HF·VF series)

### Safety measures

An abnormal state for varistors (ZNR surge absorbers) of the D type/V series and SMD-Type/HF, VF Series (hereinafter the product or "the surge absorber") that results from a problem with service conditions (materials used, the surrounding environment, power conditions, circuit conditions, etc.) may cause a fire accident, electric shock accident, burn accident, or product failure. Matters to note when handling this product will hereinafter be described. What is described below should be checked sufficiently before the product is used.

#### ■ Confirming rated capabilities

Use the surge absorber within the range of its rated capabilities. Each type of surge absorber has specified rated capabilities including a maximum allowable circuit voltage, a surge current tolerance, an energy tolerance, an impulse lifespan (surge lifespan), average pulse power, and a service temperature. Using the surge absorber under severe service conditions that are beyond the rated capabilities causes degraded performance of the surge absorber or destruction of a circuit element, which may lead to smoke generation, ignition, etc.

#### ■ Take the following measures in order to avoid an accident caused by expected phenomenon.

- (1) Destruction of the surge absorber may scatter its fractured pieces around. To protect other elements from these pieces, set product in a case or shield it with a cover.
- (2) Do not place the surge absorber near combustible materials (vinyl cable, resin mold, etc.). If avoiding the vicinity of combustible materials is difficult, protect the combustible material with an incombustible cover.

#### (3) Surge absorber placed between lines

When the surge absorber is placed between lines, connect a normal type current fuse in series with the surge absorber.

\* See "Current fuse" in the "Circuit design and circuit board design" section.

#### (4) Surge absorber placed between a line and the ground

- ① When the surge absorber is placed between a line and the ground, even if the surge absorber short-circuits, ground resistance will remain in the section between the line and the ground, leaving a possibility that the current fuse won't blow, in which case the outer sheath resin of the surge absorber may generate smoke or ignite due to current flow. To prevent such a case, place an earth leakage breaker in a location closer to the power supply than the surge absorber. When not using an earth leakage breaker, use a current fuse and temperature fuse in series with each other.

\* See Table 1 in the "Circuit design and circuit board design" section.

- ② When the surge absorber is placed between a live part and a metal case, it may cause electric shock if the surge absorber short-circuits. To avoid this, ground the metal case or shield it to prevent direct contact with the metal case.

#### ■ In case the surge absorber should short-circuit and generate smoke or ignite, immediately cut off current flow to the surge absorber.

#### ■ Rated voltage for UL certification, etc.

To allow the surge absorber to meet leak current requirements, etc., a maximum allowable circuit voltage and rated voltage are specified for the surge absorber.

When applying for UL certification, etc. of a device equipped with a surge absorber, ensure the working voltage of the device does not exceed the rated voltage of the surge absorber.

#### ■ An unexpected sharp rise in the working voltage, an incoming excessive surge, etc., may cause the surge absorber to generate smoke or ignite.

In such a case, fire spreading through the device should be prevented to avoid expanded damage. To achieve this, take a multi-protection measure, such as adopting fire-resistant materials that make up the outer shell components and structural materials.

## Use environments and cleaning conditions

- Do not use the surge absorber in an outdoor environment where the surge absorber is exposed to sunlight.
- Do not use the surge absorber in which direct sunlight hits the surge absorber or near a heating element where the temperature of the surge absorber would rise above its working temperature.
- Do not use the surge absorber in a place where the surge absorber is exposed to wind or rain or a highly humid place where steam is emitted or dew concentrates.
- Do not use the surge absorber in a place filled with dust or salt, in an atmosphere contaminated with a corrosive gas, etc., or in liquids such as water, oil, chemical, or organic solvents.
- Do not wash the surge absorber with a solvent (thinner, acetone, etc.) that damages the outer sheath resin.

## Response to anomalies and handling conditions

Be careful not to drop the surge absorber on the floor, etc. The product is likely to suffer mechanical or electrical damage when dropped on the floor. Avoid using such a product.

## Reliability

A capacitor conforming to "AEC-Q200" refers to a capacitor having passed some or all of evaluation test items defined in AEC-Q200.

To know the detailed specifications of each capacitor or specific evaluation test scores, please contact us.

We issue a delivery specification sheet for each product ordered. Please confirm the delivery specification sheet when you place an order with us.

## Circuit design and circuit board design

Meet the following requirements. Not following the requirements can result in a shorter lifespan of the surge absorber or its failure.

- Choose a surge absorber whose maximum allowable circuit voltage has a margin relative to the maximum voltage range including source voltage fluctuations.
  - \* See Table 1 in the "Circuit design and circuit board design" section.
- When surges are applied intermittently to the surge absorber at short intervals (when pulses of voltages are applied in a noise simulator test, etc.), make sure that the surge power does not exceed the maximum average pulse power of the surge absorber.
- The product numbers of recommended surge absorbers to choose are shown in Table 1.

### (1) The case of placing the surge absorber between lines

When the source voltage is expected to rise temporarily due to unbalanced single-wire loads in a three-phase three-wire connection configuration, a short circuit between a voltage line and a neutral line, loss of the neutral line, or resonance of a capacitive load caused by switching on/off, use a surge absorber (varistor) indicated by "\*" in Table 1.

### (2) The case of placing the surge absorber between a line and the ground

Line-to-ground voltage may rise with a single-wire ground fault, etc. Use a recommended surge absorber in Table 1 that is different from the surge absorber placed between lines. When the device is subjected to an insulation resistance test (500 V DC), use a D-type surge absorber indicated by "\*" in Table 1.

According to "Electrical Appliance Technical Standards" based on the Electrical Appliance and Material Safety Act, when using a varistor voltage which would fail the insulation performance test, the surge absorber may be removed from the device when being subjected to the test, depending on circuit test conditions.

\* See attached table 4, appendix 4, "Electrical Appliance Technical Standards" based on the Electrical Appliance and Material Safety Act.

When conducting a withstand voltage test (1000 V AC or 1200 V AC) of the device, use the recommended D type / V series surge absorber indicated by "\*" in Table 1.

■ Current fuse

- (1) Select a surge absorber and the rated current for a current fuse to be used in a manner shown in the following table. Confirm that no secondary accident arises when the surge absorber in an actual circuit breaks. Selected rated currents of current fuses shown in the following table are exemplary one and may vary depending on circuit conditions used. Confirm the rated current by a test, etc., before using the current fuse.

<Rated currents of current fuses for the D-type / V series surge absorber>

Standard product number	ERZV05D□□□	ERZV07D□□□	ERZV09D□□□	ERZV10D□□□	ERZV14D□□□	ERZV20D□□□
Rating current	3 A max.	5 A max.	7 A max.	7 A max.	10 A max.	10 A max.

\* Use the rated voltage of the current fuse that corresponds to the circuit voltage of a circuit including the current fuse.

<Rated current of a current fuse for the SMD-type / VF series surge absorber>

Standard product number	ERZVF□M□□□
Rating current	5 A max.

\* Use the rated voltage of the current fuse that corresponds to the circuit voltage of a circuit including the current fuse.

\* For the HF series surge absorber, select the rated current of the fuse after confirming the way the fuse handles a load dump surge and the protective coordination action it makes when the surge absorber is destroyed.

- (2) Recommended parts where fuses are connected are shown in Table 1. When a load current to a protected device is so large as to exceed the rated current of the fuse, however, connect the fuse in a location shown in the following diagram.

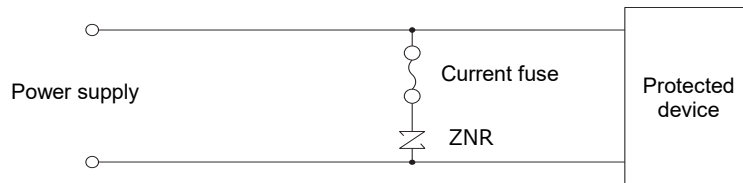

■ Temperature fuse

When connecting the surge absorber to a temperature fuse, choose a connection method and a temperature fuse that allow fine thermal coupling between the surge absorber and the temperature fuse.

Table 1 Application example of the product (ordinary application example)

Connection	Surge absorber placed between lines	Surge absorber placed between a line and the ground																																																															
		<p>DC Single-phase AC</p>	<p>DC Single-phase AC</p>																																																														
	<p>Three-phase AC</p>	<p>Three-phase AC</p>																																																															
Varistor voltage selection	<table border="1"> <thead> <tr> <th rowspan="2">ZNR</th> <th rowspan="2">Power supply voltage [AC]</th> <th colspan="2">Nominal varistor voltage</th> </tr> <tr> <th>D-type</th> <th>SMD-type</th> </tr> </thead> <tbody> <tr> <td rowspan="6">ZNR 1 ZNR 3</td> <td>100 V</td> <td>201 to 361*</td> <td>201 to 361*</td> </tr> <tr> <td>120 V</td> <td>241 to 431*</td> <td>241 to 431*</td> </tr> <tr> <td>200 V</td> <td>471 to 621*</td> <td>471</td> </tr> <tr> <td>220 V</td> <td>471 to 621*</td> <td>471</td> </tr> <tr> <td>240 V</td> <td>511, 621*</td> <td>-</td> </tr> <tr> <td>380 V</td> <td>751, 821*</td> <td>-</td> </tr> </tbody> </table>	ZNR	Power supply voltage [AC]	Nominal varistor voltage		D-type	SMD-type	ZNR 1 ZNR 3	100 V	201 to 361*	201 to 361*	120 V	241 to 431*	241 to 431*	200 V	471 to 621*	471	220 V	471 to 621*	471	240 V	511, 621*	-	380 V	751, 821*	-	<table border="1"> <thead> <tr> <th rowspan="2">ZNR</th> <th rowspan="2">Power supply voltage [AC]</th> <th colspan="2">Nominal varistor voltage</th> </tr> <tr> <th>D-type</th> <th>SMD-type</th> </tr> </thead> <tbody> <tr> <td rowspan="12">ZNR 2 ZNR 4</td> <td rowspan="6">100 V 220 V</td> <td>471</td> <td>471</td> </tr> <tr> <td>511</td> <td>-</td> </tr> <tr> <td>621*</td> <td>-</td> </tr> <tr> <td>821 or higher**</td> <td>-</td> </tr> <tr> <td>182***</td> <td>-</td> </tr> <tr> <td>-</td> <td>-</td> </tr> <tr> <td rowspan="6">230 V</td> <td>511</td> <td>-</td> </tr> <tr> <td>621*</td> <td>-</td> </tr> <tr> <td>821 or higher**</td> <td>-</td> </tr> <tr> <td>182**</td> <td>-</td> </tr> <tr> <td>112**</td> <td>-</td> </tr> <tr> <td>182***</td> <td>-</td> </tr> <tr> <td rowspan="2">380 V</td> <td>112**</td> <td>-</td> </tr> <tr> <td>182***</td> <td>-</td> </tr> </tbody> </table> <p>* Choose the element size while taking surge conditions into consideration.</p>	ZNR	Power supply voltage [AC]	Nominal varistor voltage		D-type	SMD-type	ZNR 2 ZNR 4	100 V 220 V	471	471	511	-	621*	-	821 or higher**	-	182***	-	-	-	230 V	511	-	621*	-	821 or higher**	-	182**	-	112**	-	182***	-	380 V	112**	-	182***	-
ZNR	Power supply voltage [AC]			Nominal varistor voltage																																																													
		D-type	SMD-type																																																														
ZNR 1 ZNR 3	100 V	201 to 361*	201 to 361*																																																														
	120 V	241 to 431*	241 to 431*																																																														
	200 V	471 to 621*	471																																																														
	220 V	471 to 621*	471																																																														
	240 V	511, 621*	-																																																														
	380 V	751, 821*	-																																																														
ZNR	Power supply voltage [AC]	Nominal varistor voltage																																																															
		D-type	SMD-type																																																														
ZNR 2 ZNR 4	100 V 220 V	471	471																																																														
		511	-																																																														
		621*	-																																																														
		821 or higher**	-																																																														
		182***	-																																																														
		-	-																																																														
	230 V	511	-																																																														
		621*	-																																																														
		821 or higher**	-																																																														
		182**	-																																																														
		112**	-																																																														
		182***	-																																																														
380 V	112**	-																																																															
	182***	-																																																															

**Processing conditions**

- Do not apply vibration, impact (drop impact, etc.), or pressure strong enough to crack the outer sheath resin or absorber body of the surge absorber.
- When coating the surge absorber with a resin or embedding it in a resin mold, avoid using a resin that degrades the surge absorber.
- Do not bend or apply a force to the lead of a D-type surge absorber close to the outer sheath resin.

**Mounting and storage conditions**

- When soldering the surge absorber, follow recommended soldering conditions shown in the following table so that solder or the insulation material making up the surge absorber is not melted.
- When making holes for mounting the surge absorber on the board, check the dimensions of the holes on the board, referencing the central point of the interval between the leads.  
Because the overall dimensional tolerance is large, forming the holes with high precision requires careful processing.

	Soldering method	Recommended conditions	Mater to note
D-type	Flow soldering (solder bath immersion method)	260 °C, 10 seconds or less	The D-type surge absorber should not be soldered by reflow soldering.
SMD-type	Flow soldering (solder bath immersion method)	260 °C, 10 seconds or less	A high component mounting density may lead to poor solderability. In such a case, consider vent hole formation.
	Reflow soldering (controlled atmosphere heating method)	Refer to the recommended soldering temperature profile.	When a land is excessively larger than the terminal surface of a component, the component may shift position when solder is melted.

- Note 1: Soldering the surge absorber under soldering conditions different from the recommended soldering conditions requires extra checking to ensure it won't cause any problems.  
Additional soldering is allowed only once. It must be done within 5 seconds, with the soldering iron temperature kept at 400 °C or lower.
- Note 2: A temperature profile may include a large error, depending on the measurement method used.  
Be careful in such cases.
- Note 3: Board temperatures vary depending on the sizes of boards and mounting densities. Confirm the temperature for each type of board.

<Recommended soldering temperature profile>

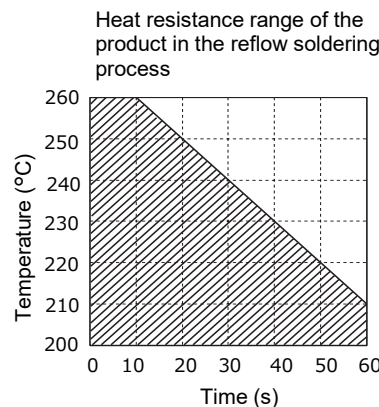
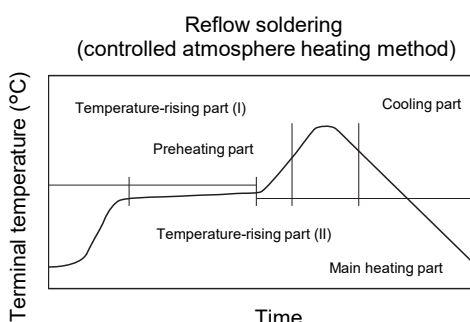
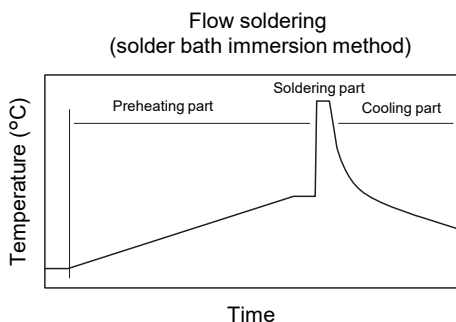

Preheating part	Normal temperature to 130 °C	120 seconds or less
Soldering part	260 °C or less	10 seconds or less
Cooling part	Gradual cooling (cooling under the normal temperature)	

Temperature-rising part I	Normal temperature to preheating temperature	30 to 60 seconds
Preheating part	150 °C to 180 °C	60 to 120 seconds
Temperature-rising part II	Preheating temperature to 200 °C	2 to 6 °C per second
Main heating part	Refer to the heat resistance range of the product in the reflow soldering process.	
Cooling part	200 °C to 100 °C	1 to 4 °C per second

\* Do not perform reflow soldering more than two times.

- Mounting the surge absorber (SMD-type)  
When mounting the surge absorber on the board, make sure that no excessive impact or load, such as pressure from a suction nozzle for mounting the absorber, positional shift, or mechanical impact/stress caused by a positioning of the absorber, is applied to the surge absorber. There are cases where the surge absorber shifts from its intended position when mounted on the board. In such cases, consider a method of bonding the board and the outer sheath resin together.
- Do not keep the product in a high-temperature or high-humidity condition. Keep the surge absorber in a room with a temperature of 40 °C or lower and a relative humidity of 75% or lower and use the surge absorber within two years of storage. Check the solderability of a surge absorber stored for a long period (two years or more) before using the surge absorber.
- Keep the surge absorber in a place where no corrosive gas atmosphere (hydrogen sulfide, sulfurous acid, chlorine, ammonia, etc.) is present.
- Keep the surge absorber in a place where the surge absorber is protected from direct sunlight, dew concentration, etc.

# Mouser Electronics

Authorized Distributor

Click to View Pricing, Inventory, Delivery & Lifecycle Information:

## Panasonic:

[ERZ-V07D330](#) [ERZ-V20D511](#) [ERZ-VA5D471](#) [ERZ-V07D180](#) [ERZ-V05D471CS](#) [ERZ-V10D270](#) [ERZ-V14D101](#)  
[ERZ-V07D101](#) [ERZ-V14D330](#) [ERZ-V20D621](#) [ERZ-V20R271](#) [ERZ-V20R431](#) [ERZ-V20D911](#) [ERZ-V09D241](#) [ERZ-](#)  
[V05D121](#) [ERZ-V05D180](#) [ERZ-V05D201](#) [ERZ-V05D220](#) [ERZ-V05D241](#) [ERZ-V05D330](#) [ERZ-V05D431](#) [ERZ-](#)  
[V05D470](#) [ERZ-V05D471](#) [ERZ-V05D680](#) [ERZ-V07D151](#) [ERZ-V07D220](#) [ERZ-V07D221](#) [ERZ-V07D241](#) [ERZ-](#)  
[V07D270](#) [ERZ-V07D271](#) [ERZ-V07D390](#) [ERZ-V07D391](#) [ERZ-V07D431](#) [ERZ-V07D470](#) [ERZ-V07D471](#) [ERZ-](#)  
[V07D560](#) [ERZ-V07D680](#) [ERZ-V07D820](#) [ERZ-V10D101](#) [ERZ-V10D182](#) [ERZ-V10D201](#) [ERZ-V10D221](#) [ERZ-](#)  
[V10D271](#) [ERZ-V10D330](#) [ERZ-V10D390](#) [ERZ-V10D431](#) [ERZ-V10D470](#) [ERZ-V10D471](#) [ERZ-V10D511](#) [ERZ-](#)  
[V10D560](#) [ERZ-V10D621](#) [ERZ-V14D112](#) [ERZ-V14D182](#) [ERZ-V14D201](#) [ERZ-V14D220](#) [ERZ-V14D221](#) [ERZ-](#)  
[V14D241](#) [ERZ-V14D270](#) [ERZ-V14D271](#) [ERZ-V14D390](#) [ERZ-V14D391](#) [ERZ-V14D431](#) [ERZ-V14D470](#) [ERZ-](#)  
[V14D471](#) [ERZ-V20D102](#) [ERZ-V20D112](#) [ERZ-V20D201](#) [ERZ-V20D221](#) [ERZ-V20D241](#) [ERZ-V20D271](#) [ERZ-](#)  
[V20D361](#) [ERZ-V20D391](#) [ERZ-V20D431](#) [ERZ-V20D471](#) [ERZ-V20D820](#) [ERZ-VA5D221](#) [ERZ-VA7V270](#) [ERZ-](#)  
[V05D560](#) [ERZ-V10D220](#) [ERZ-V14V431CS](#) [ERZ-VA7D471](#) [ERZ-V10D681](#) [ERZ-V14D821](#) [ERZ-V14V751CS](#) [ERZ-](#)  
[V05D101](#) [ERZ-V05D101CS](#) [ERZ-V05D121CS](#) [ERZ-V05D151](#) [ERZ-V05D151CS](#) [ERZ-V05D180CS](#) [ERZ-](#)  
[V05D201CS](#) [ERZ-V05D220CS](#) [ERZ-V05D221](#) [ERZ-V05D221CS](#) [ERZ-V05D241CS](#) [ERZ-V05D270](#) [ERZ-](#)  
[V05D270CS](#) [ERZ-V05D271](#) [ERZ-V05D271CS](#) [ERZ-V05D330CS](#)