

Surface Mount Schottky Power Rectifier

SMA Power Surface Mount Package

MBRA1H100, NRVBA1H100, NRVBA1H100N

Employing the Schottky Barrier principle in a large area metal-to-silicon power diode. State of the art geometry features epitaxial construction with oxide passivation and metal overlay contact. Ideally suited for low voltage, high frequency rectification, or as free wheeling and polarity diodes in surface mount applications where compact size and weight are critical to the system.

Features

- Small Compact Surface Mountable Package with J-Bent Leads
- Rectangular Package for Automated Handling
- Highly Stable Oxide Passivated Junction
- Low Forward Voltage Drop
- Guardring for Stress Protection
- NRVBA Prefix for Automotive and Other Applications Requiring Unique Site and Control Change Requirements; AEC-Q101 Qualified and PPAP Capable*
- These Devices are Pb-Free, Halogen Free/BFR Free and are RoHS Compliant

Mechanical Characteristics:

- Case: Epoxy, Molded
- Weight: 70 mg (approximately)
- Finish: All External Surfaces Corrosion Resistant and Terminal Leads are Readily Solderable
- Lead and Mounting Surface Temperature for Soldering Purposes: 260°C Max. for 10 Seconds
- Polarity: Cathode Lead Indicated by Polarity Band
- ESD Ratings:
 - ◆ Machine Model = C
 - ◆ Human Body Model = 3B
- Device Meets MSL 1 Requirements



ON Semiconductor®

www.onsemi.com

SCHOTTKY BARRIER RECTIFIER

1.0 AMPERES, 100 VOLTS



SMA
CASE 403D

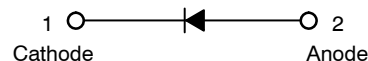

MARKING DIAGRAMS



A110 = Device Code
 A = Assembly Location**
 Y = Year
 WW = Work Week
 ▪ = Pb-Free Package

(Note: Microdot may be in either location)

**The Assembly Location code (A) is front side optional. In cases where the Assembly Location is stamped in the package bottom (molding ejector pin), the front side assembly code may be blank.

ORDERING INFORMATION

Device	Package	Shipping†
MBRA1H100T3G	SMA (Pb-Free)	5,000 / Tape & Reel
NRVBA1H100T3G*	SMA (Pb-Free)	5,000 / Tape & Reel
NRVBA1H100NT3G*	SMA (Pb-Free)	5,000 / Tape & Reel

†For information on tape and reel specifications, including part orientation and tape sizes, please refer to our Tape and Reel Packaging Specification Brochure, BRD8011/D.

MBRA1H100, NRVBA1H100, NRVBA1H100N

MAXIMUM RATINGS

Rating	Symbol	Value	Unit
Peak Repetitive Reverse Voltage Working Peak Reverse Voltage DC Blocking Voltage	V_{RRM} V_{RWM} V_R	100	V
Average Rectified Forward Current ($T_L = 167^\circ\text{C}$)	I_O	1.0	A
Non-Repetitive Peak Surge Current (Surge Applied at Rated Load Conditions Halfwave, Single Phase, 60 Hz)	I_{FSM}	50	A
Storage and Operating Junction Temperature Range (Note 1)	T_{stg}, T_J	-65 to +175	$^\circ\text{C}$

Stresses exceeding those listed in the Maximum Ratings table may damage the device. If any of these limits are exceeded, device functionality should not be assumed, damage may occur and reliability may be affected.

- The heat generated must be less than the thermal conductivity from Junction-to-Ambient: $dP_D/dT_J < 1/R_{\theta JA}$.

THERMAL CHARACTERISTICS

Characteristic	Symbol	Value	Unit
Thermal Resistance, Junction-to-Lead (Note 2)	Ψ_{JCL}	14	$^\circ\text{C/W}$
Thermal Resistance, Junction-to-Ambient (Note 2)	$R_{\theta JA}$	75	$^\circ\text{C/W}$
Thermal Resistance, Junction-to-Ambient (Note 3)	$R_{\theta JA}$	280	$^\circ\text{C/W}$

- Mounted with 700 mm² copper pad size (Approximately 1 in²) 1 oz FR4 Board.
- Mounted with pad size approximately 6 mm² copper, 1 oz FR4 Board.

ELECTRICAL CHARACTERISTICS

Characteristic	Symbol	Value	Unit
Maximum Instantaneous Forward Voltage (Note 4) ($I_F = 1.0 \text{ A}, T_J = 25^\circ\text{C}$) ($I_F = 2.0 \text{ A}, T_J = 25^\circ\text{C}$) ($I_F = 1.0 \text{ A}, T_J = 125^\circ\text{C}$) ($I_F = 2.0 \text{ A}, T_J = 125^\circ\text{C}$)	V_F	0.76 0.84 0.61 0.68	V
Maximum Instantaneous Reverse Current (Note 4) (Rated dc Voltage, $T_J = 25^\circ\text{C}$) (Rated dc Voltage, $T_J = 125^\circ\text{C}$)	I_R	40 0.5	μA mA

Product parametric performance is indicated in the Electrical Characteristics for the listed test conditions, unless otherwise noted. Product performance may not be indicated by the Electrical Characteristics if operated under different conditions.

- Pulse Test: Pulse Width $\leq 380 \mu\text{s}$, Duty Cycle $\leq 2.0\%$.

MBRA1H100, NRVBA1H100, NRVBA1H100N

TYPICAL CHARACTERISTICS

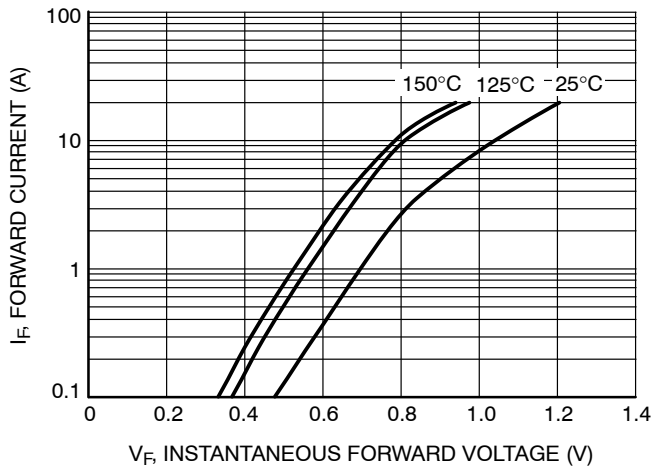

Figure 1. Typical Forward Voltage

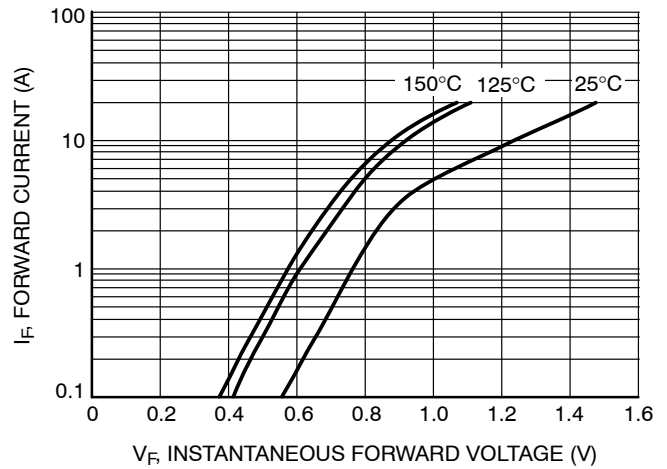

Figure 2. Maximum Forward Voltage

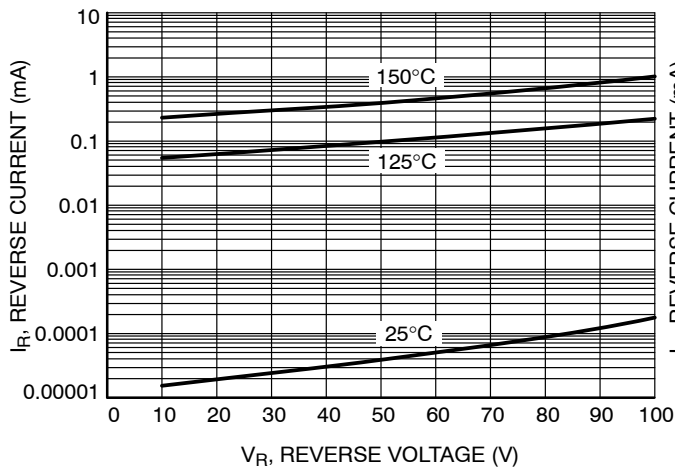

Figure 3. Typical Reverse Current

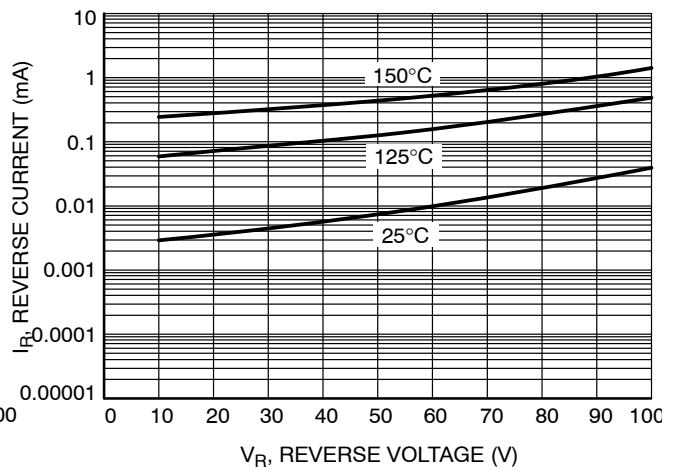

Figure 4. Maximum Reverse Current

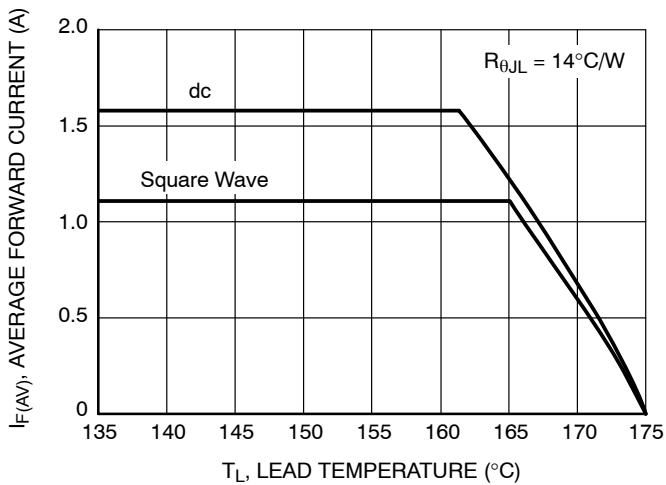

Figure 5. Current Derating

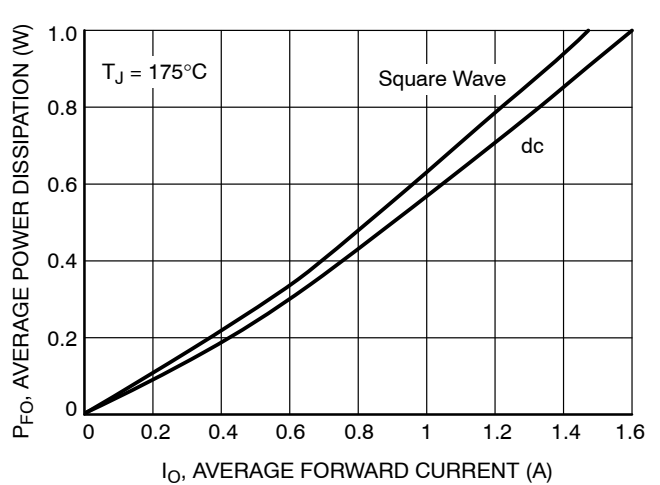

Figure 6. Forward Power Dissipation

MBRA1H100, NRVBA1H100, NRVBA1H100N

TYPICAL CHARACTERISTICS

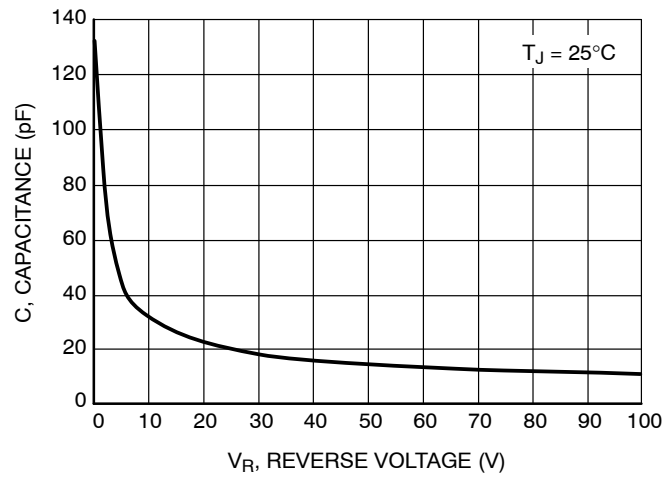

Figure 7. Capacitance

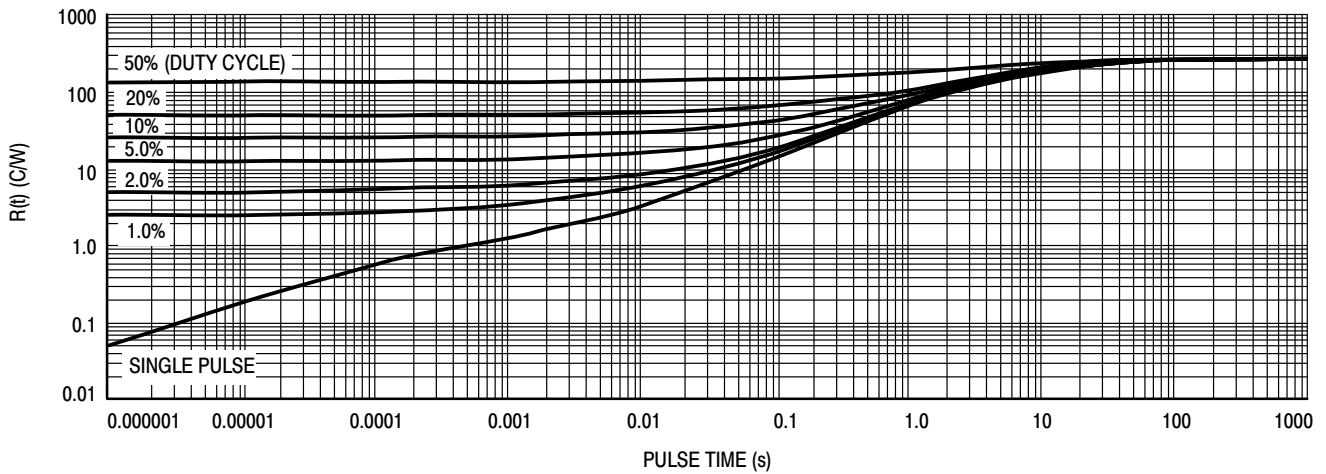

Figure 8. Thermal Response, Junction-to-Ambient (6 mm² pad)

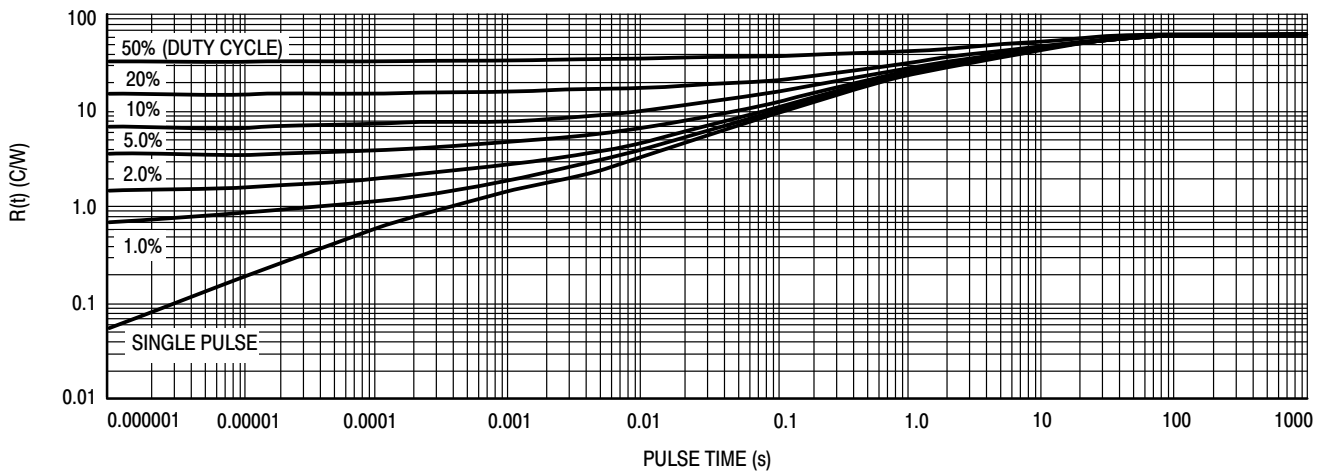

Figure 9. Thermal Response, Junction-to-Ambient (1 in² pad)

MECHANICAL CASE OUTLINE

PACKAGE DIMENSIONS

ON Semiconductor®



STYLE 1 STYLE 2

SCALE 1:1

SMA CASE 403D ISSUE H

DATE 23 SEP 2015

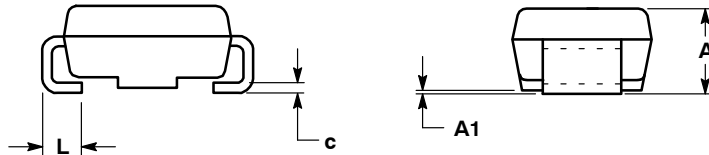
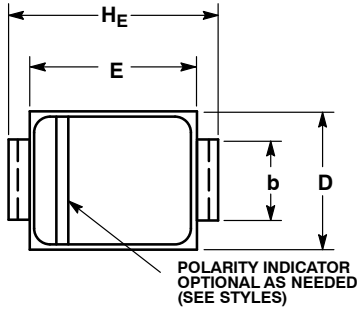

SOLDERING FOOTPRINT*

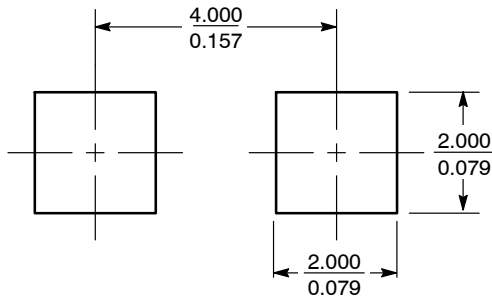

SCALE 8:1 (mm/inches)

*For additional information on our Pb-Free strategy and soldering details, please download the ON Semiconductor Soldering and Mounting Techniques Reference Manual, SOLDERRM/D.

NOTES:

1. DIMENSIONING AND TOLERANCING PER ANSI Y14.5M, 1982.
2. CONTROLLING DIMENSION: INCH.
3. DIMENSION b SHALL BE MEASURED WITHIN DIMENSION L.

DIM	MILLIMETERS			INCHES		
	MIN	NOM	MAX	MIN	NOM	MAX
A	1.97	2.10	2.20	0.078	0.083	0.087
A1	0.05	0.10	0.20	0.002	0.004	0.008
b	1.27	1.45	1.63	0.050	0.057	0.064
c	0.15	0.28	0.41	0.006	0.011	0.016
D	2.29	2.60	2.92	0.090	0.103	0.115
E	4.06	4.32	4.57	0.160	0.170	0.180
HE	4.83	5.21	5.59	0.190	0.205	0.220
L	0.76	1.14	1.52	0.030	0.045	0.060

GENERIC MARKING DIAGRAM*

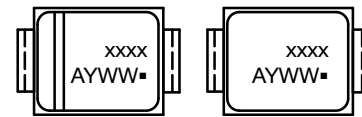

STYLE 1

STYLE 2

- xxxx = Specific Device Code
- A = Assembly Location
- Y = Year
- WW = Work Week
- = Pb-Free Package

*This information is generic. Please refer to device data sheet for actual part marking. Pb-Free indicator, "G" or microdot "▪", may or may not be present.

STYLE 1:
PIN 1. CATHODE (POLARITY BAND)
2. ANODE

STYLE 2:
NO POLARITY

DOCUMENT NUMBER:	98AON04079D	Electronic versions are uncontrolled except when accessed directly from the Document Repository. Printed versions are uncontrolled except when stamped "CONTROLLED COPY" in red.
DESCRIPTION:	SMA	PAGE 1 OF 1

ON Semiconductor and are trademarks of Semiconductor Components Industries, LLC dba ON Semiconductor or its subsidiaries in the United States and/or other countries. ON Semiconductor reserves the right to make changes without further notice to any products herein. ON Semiconductor makes no warranty, representation or guarantee regarding the suitability of its products for any particular purpose, nor does ON Semiconductor assume any liability arising out of the application or use of any product or circuit, and specifically disclaims any and all liability, including without limitation special, consequential or incidental damages. ON Semiconductor does not convey any license under its patent rights nor the rights of others.

ON Semiconductor and  are trademarks of Semiconductor Components Industries, LLC dba ON Semiconductor or its subsidiaries in the United States and/or other countries. ON Semiconductor owns the rights to a number of patents, trademarks, copyrights, trade secrets, and other intellectual property. A listing of ON Semiconductor's product/patent coverage may be accessed at www.onsemi.com/site/pdf/Patent-Marking.pdf. ON Semiconductor reserves the right to make changes without further notice to any products herein. ON Semiconductor makes no warranty, representation or guarantee regarding the suitability of its products for any particular purpose, nor does ON Semiconductor assume any liability arising out of the application or use of any product or circuit, and specifically disclaims any and all liability, including without limitation special, consequential or incidental damages. Buyer is responsible for its products and applications using ON Semiconductor products, including compliance with all laws, regulations and safety requirements or standards, regardless of any support or applications information provided by ON Semiconductor. "Typical" parameters which may be provided in ON Semiconductor data sheets and/or specifications can and do vary in different applications and actual performance may vary over time. All operating parameters, including "Typicals" must be validated for each customer application by customer's technical experts. ON Semiconductor does not convey any license under its patent rights nor the rights of others. ON Semiconductor products are not designed, intended, or authorized for use as a critical component in life support systems or any FDA Class 3 medical devices or medical devices with a same or similar classification in a foreign jurisdiction or any devices intended for implantation in the human body. Should Buyer purchase or use ON Semiconductor products for any such unintended or unauthorized application, Buyer shall indemnify and hold ON Semiconductor and its officers, employees, subsidiaries, affiliates, and distributors harmless against all claims, costs, damages, and expenses, and reasonable attorney fees arising out of, directly or indirectly, any claim of personal injury or death associated with such unintended or unauthorized use, even if such claim alleges that ON Semiconductor was negligent regarding the design or manufacture of the part. ON Semiconductor is an Equal Opportunity/Affirmative Action Employer. This literature is subject to all applicable copyright laws and is not for resale in any manner.

PUBLICATION ORDERING INFORMATION

LITERATURE FULFILLMENT:

Email Requests to: orderlit@onsemi.com

ON Semiconductor Website: www.onsemi.com

TECHNICAL SUPPORT

North American Technical Support:
Voice Mail: 1 800-282-9855 Toll Free USA/Canada
Phone: 011 421 33 790 2910

Europe, Middle East and Africa Technical Support:

Phone: 00421 33 790 2910

For additional information, please contact your local Sales Representative

Mouser Electronics

Authorized Distributor

Click to View Pricing, Inventory, Delivery & Lifecycle Information:

[ON Semiconductor:](#)

[MBRA1H100T3G](#) [NRVBA1H100T3G](#) [NRVBA1H100T3G-VF01](#)