

**Low Noise Silicon Bipolar RF Transistor**

- For low noise, high-gain broadband amplifiers at collector currents from 2 mA to 30 mA
- $f_T = 8$  GHz,  $NF_{min} = 0.9$  dB at 900 MHz
- Pb-free (RoHS compliant) package
- Qualification report according to AEC-Q101 available



**ESD (Electrostatic discharge) sensitive device, observe handling precaution!**

Type	Marking	Pin Configuration			Package
BFR183	RHs	1=B	2=E	3=C	SOT23

**Maximum Ratings** at  $T_A = 25$  °C, unless otherwise specified

Parameter	Symbol	Value	Unit
Collector-emitter voltage	$V_{CEO}$	12	V
Collector-emitter voltage	$V_{CES}$	20	
Collector-base voltage	$V_{CBO}$	20	
Emitter-base voltage	$V_{EBO}$	2	
Collector current	$I_C$	65	mA
Base current	$I_B$	5	
Total power dissipation <sup>1)</sup> $T_S \leq 60$ °C	$P_{tot}$	450	mW
Junction temperature	$T_J$	150	°C
Storage temperature	$T_{Stg}$	-55 ... 150	

**Thermal Resistance**

Parameter	Symbol	Value	Unit
Junction - soldering point <sup>2)</sup>	$R_{thJS}$	200	K/W

<sup>1)</sup>  $T_S$  is measured on the collector lead at the soldering point to the pcb

<sup>2)</sup> For the definition of  $R_{thJS}$  please refer to Application Note AN077 (Thermal Resistance Calculation)

**Electrical Characteristics** at  $T_A = 25\text{ °C}$ , unless otherwise specified

Parameter	Symbol	Values			Unit
		min.	typ.	max.	
<b>DC Characteristics</b>					
Collector-emitter breakdown voltage $I_C = 1\text{ mA}, I_B = 0$	$V_{(BR)CEO}$	12	-	-	V
Collector-emitter cutoff current $V_{CE} = 20\text{ V}, V_{BE} = 0$	$I_{CES}$	-	-	100	$\mu\text{A}$
Collector-base cutoff current $V_{CB} = 10\text{ V}, I_E = 0$	$I_{CBO}$	-	-	100	nA
Emitter-base cutoff current $V_{EB} = 1\text{ V}, I_C = 0$	$I_{EBO}$	-	-	1	$\mu\text{A}$
DC current gain $I_C = 15\text{ mA}, V_{CE} = 8\text{ V}$ , pulse measured	$h_{FE}$	70	100	140	-

**Electrical Characteristics at  $T_A = 25\text{ }^\circ\text{C}$ , unless otherwise specified**

Parameter	Symbol	Values			Unit
		min.	typ.	max.	
<b>AC Characteristics (verified by random sampling)</b>					
Transition frequency $I_C = 25\text{ mA}$ , $V_{CE} = 8\text{ V}$ , $f = 500\text{ MHz}$	$f_T$	6	8	-	GHz
Collector-base capacitance $V_{CB} = 10\text{ V}$ , $f = 1\text{ MHz}$ , $V_{BE} = 0$ , emitter grounded	$C_{cb}$	-	0.37	0.57	pF
Collector emitter capacitance $V_{CE} = 10\text{ V}$ , $f = 1\text{ MHz}$ , $V_{BE} = 0$ , base grounded	$C_{ce}$	-	0.2	-	
Emitter-base capacitance $V_{EB} = 0.5\text{ V}$ , $f = 1\text{ MHz}$ , $V_{CB} = 0$ , collector grounded	$C_{eb}$	-	1.1	-	
Minimum noise figure $I_C = 5\text{ mA}$ , $V_{CE} = 8\text{ V}$ , $Z_S = Z_{Sopt}$ , $f = 900\text{ MHz}$ $f = 1.8\text{ GHz}$	$NF_{min}$	-	0.9	-	dB
Power gain, maximum stable <sup>1)</sup> $I_C = 15\text{ mA}$ , $V_{CE} = 8\text{ V}$ , $Z_S = Z_{Sopt}$ , $Z_L = Z_{Lopt}$ , $f = 900\text{ MHz}$	$G_{ms}$	-	17.5	-	dB
Power gain, maximum available <sup>1)</sup> $I_C = 15\text{ mA}$ , $V_{CE} = 8\text{ V}$ , $Z_S = Z_{Sopt}$ , $Z_L = Z_{Lopt}$ , $f = 1.8\text{ GHz}$	$G_{ma}$	-	11.5	-	dB
Transducer gain $I_C = 15\text{ mA}$ , $V_{CE} = 8\text{ V}$ , $Z_S = Z_L = 50\text{ }\Omega$ , $f = 900\text{ MHz}$ $f = 1.8\text{ MHz}$	$ S_{21e} ^2$	-	14.5	-	dB
		-	9	-	

<sup>1)</sup> $G_{ma} = |S_{21e} / S_{12e}| (k - (k^2 - 1)^{1/2})$ ,  $G_{ms} = |S_{21} / S_{12}|$

Total power dissipation  $P_{tot} = f(T_S)$

Permissible Pulse Load  $R_{thJS} = f(t_p)$

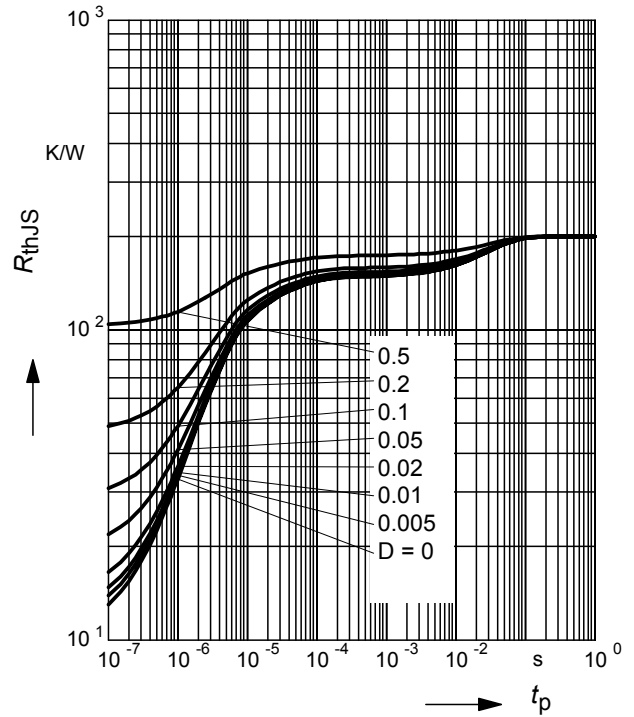
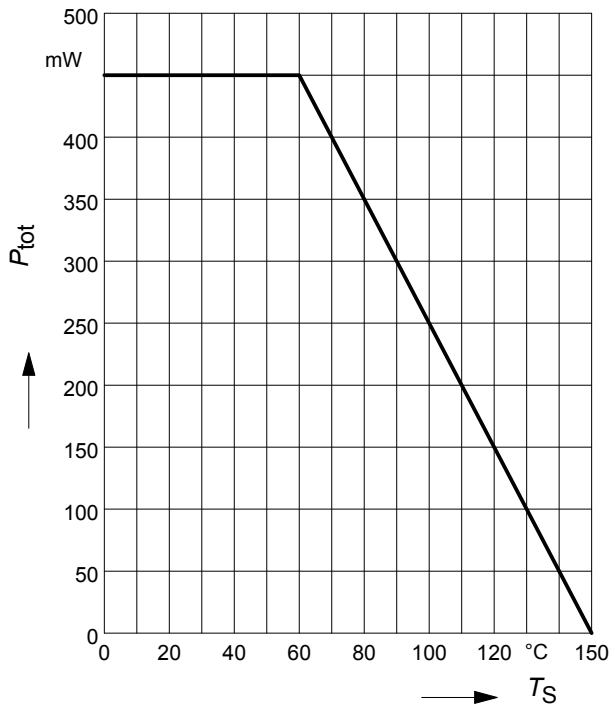

**Permissible Pulse Load**

$P_{totmax}/P_{totDC} = f(t_p)$

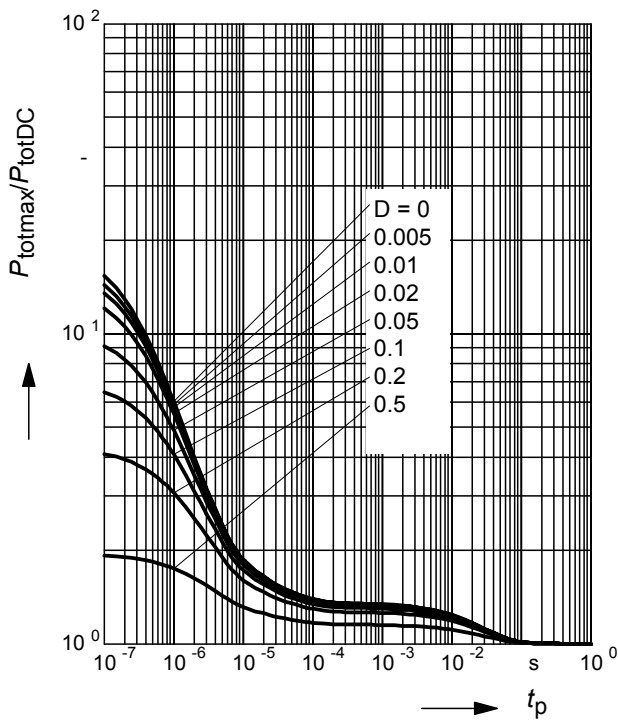

Package Outline

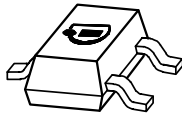

1) Lead width can be 0.6 max. in dambar area

SOT23-PO V08

Foot Print

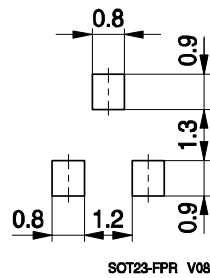

SOT23-FPR V08

Marking Layout

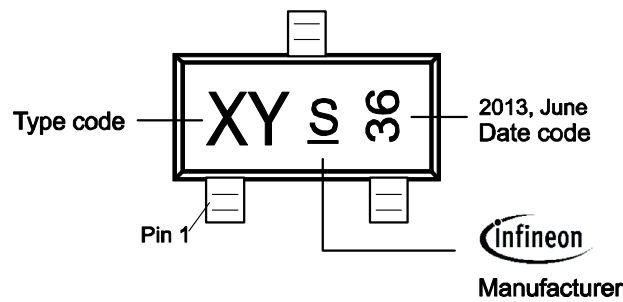

Standard Packing

Reel o 180 mm: 3.000 Pieces / Reel  
 Reel o 330 mm = 10.000 Pieces / Reel

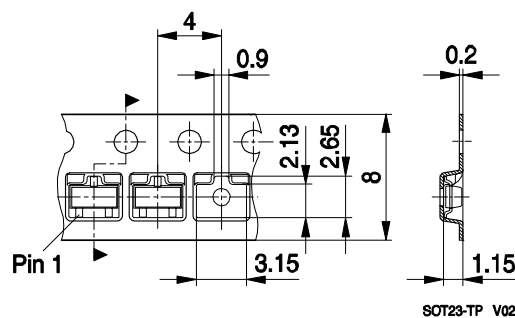

SOT23-TP V02

**Edition 2009-11-16**

**Published by  
Infineon Technologies AG  
81726 Munich, Germany**

**© 2009 Infineon Technologies AG  
All Rights Reserved.**

### **Legal Disclaimer**

The information given in this document shall in no event be regarded as a guarantee of conditions or characteristics. With respect to any examples or hints given herein, any typical values stated herein and/or any information regarding the application of the device, Infineon Technologies hereby disclaims any and all warranties and liabilities of any kind, including without limitation, warranties of non-infringement of intellectual property rights of any third party.

### **Information**

For further information on technology, delivery terms and conditions and prices, please contact the nearest Infineon Technologies Office ([www.infineon.com](http://www.infineon.com)).

### **Warnings**

Due to technical requirements, components may contain dangerous substances. For information on the types in question, please contact the nearest Infineon Technologies Office.

Infineon Technologies components may be used in life-support devices or systems only with the express written approval of Infineon Technologies, if a failure of such components can reasonably be expected to cause the failure of that life-support device or system or to affect the safety or effectiveness of that device or system. Life support devices or systems are intended to be implanted in the human body or to support and/or maintain and sustain and/or protect human life. If they fail, it is reasonable to assume that the health of the user or other persons may be endangered.

# Mouser Electronics

Authorized Distributor

Click to View Pricing, Inventory, Delivery & Lifecycle Information:

[Infineon:](#)

[BFR 183 E6327](#)