

PLEASE CHECK WWW.MOLEX.COM FOR LATEST PART INFORMATION

Part Number: [0512812694](#)
Status: **Active**
Overview: FFC-FPC (SMT)
Description: 0.50mm Pitch Easy-On FFC/FPC Connector, Surface Mount, Right-Angle, Non-ZIF, Dual Contact Style, 1.20mm Mated Height, 26 Circuits, Gold (Au) Plating

Documents:

[3D Model](#) [Packaging Specification SPK-51281-001-001 \(PDF\)](#)
[Drawing \(PDF\)](#) [RoHS Certificate of Compliance \(PDF\)](#)
[Product Specification PS-51281-003-001 \(PDF\)](#)

General

Product Family FFC/FPC Connectors
 Series [51281](#)
 Overview [FFC-FPC \(SMT\)](#)
 Product Name Easy-On
 UPC 822348699797

Physical

Actuator Type Non-ZIF
 Circuits (Loaded) 26
 Color - Resin Natural
 Contact Position Dual
 Durability (mating cycles max) 20
 Mated Height 1.20mm
 Material - Metal Phosphor Bronze
 Material - Plating Mating Gold
 Material - Plating Termination Tin
 Net Weight 148.827/mg
 Number of Rows 1
 Orientation Right Angle
 PCB Locator No
 PCB Mounting Surface Mount
 PCB Retention Yes
 Packaging Type Embossed Tape on Reel
 Pitch - Mating Interface 0.50mm
 Plating min - Mating 0.102µm
 Plating min - Termination 1.016µm
 Polarized to PCB Yes
 Stackable No
 Surface Mount Compatible (SMC) N/A
 Temperature Range - Operating -20° to +85°C
 Wire/Cable Type FFC/FPC

Electrical

Current - Maximum per Contact 0.5A
 Voltage - Maximum 50V

Material Info

Reference - Drawing Numbers

Packaging Specification SPK-51281-001-001
 Product Specification PS-51281-003-001
 Sales Drawing SD-51281-011, SD-51281-012

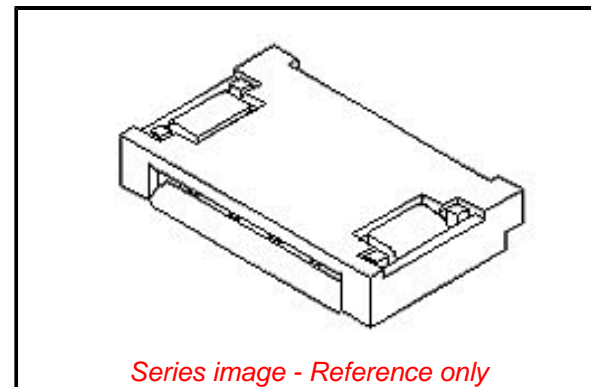

EU ELV

Not Relevant

EU RoHS

Compliant

REACH SVHC

Not Contained Per -
 ED/61/2018 (27 June
 2018)

Halogen-Free

Status

Low-Halogen

For more information, please visit [Contact US](#)

China ROHS

ELV

RoHS Phthalates

China RoHS

Green Image

Not Relevant

Not Contained

Search Parts in this Series

[51281 Series](#)

PLEASE CHECK WWW.MOLEX.COM FOR LATEST PART INFORMATION

Mouser Electronics

Authorized Distributor

Click to View Pricing, Inventory, Delivery & Lifecycle Information:

[Molex:](#)

[51281-2694](#)